

# **RULES**

## **FOR THE CLASSIFICATION AND CONSTRUCTION OF SHIPS CARRYING LIQUEFIED GASES IN BULK**

### **PART II**

#### **SHIP ARRANGEMENT**

ND No. 2-020101-176-E



**St. Petersburg**  
**2023**

# **RULES FOR THE CLASSIFICATION AND CONSTRUCTION OF SHIPS CARRYING LIQUEFIED GASES IN BULK**

---

Rules for the Classification and Construction of Ships Carrying Liquefied Gases in Bulk of Russian Maritime Register of Shipping (RS, the Register) have been approved in accordance with the established approval procedure and come into force on 1 January 2023.

The present edition of the Rules is based on the 2022 edition taking into account the amendments developed immediately before publication.

The Rules establish requirements, which are specific for ships carrying liquefied gases in bulk, and supplement the Rules for the Classification and Construction of Sea-Going Ships and Rules for the Equipment of Sea-Going Ships of Russian Maritime Register of Shipping.

The Rules are published in the following parts:

Part I "Classification";

Part II "Ship Arrangement";

Part III "Stability. Subdivision. Freeboard";

Part IV "Cargo Containment";

Part V "Fire Protection";

Part VI "Systems and Piping";

Part VII "Electrical Equipment";

Part VIII "Instrumentation and Automation Systems";

Part IX "Materials and Welding";

Part X "Special Requirements".

The Annexes to the Rules are published separately.

**REVISION HISTORY<sup>1</sup>**

(purely editorial amendments are not included in the Revision History)

Amended paras/chapters/sections	Information on amendments	Number and date of the Circular Letter	Entry-into-force date
<a href="#">Para 1.6</a>	Editorial amendment of 29.04.2025: requirements have been harmonized with the Russian version of the Rules	—	01.01.2023

---

<sup>1</sup> Amendments and additions introduced at re-publication or by new versions based on circular letters or editorial amendments.

## 1 GENERAL

**1.1** The ship with a machinery installation arranged aft is taken as the basic type of a ship carrying liquefied gases in bulk<sup>1</sup>.

**1.2** Hold spaces and turret compartments shall be separated from ship's spaces in accordance with the requirements of 2.3 of Part V "Fire Protection" of the Rules for the Classification and Construction of Ships Carrying Liquefied Gases in Bulk<sup>2</sup>.

**1.3** The ships having cargo tanks with the secondary barrier, which are designed for the carriage of cargoes at a temperature below  $-10\text{ }^{\circ}\text{C}$ , shall have a double bottom over the entire length of the cargo area, and also longitudinal bulkheads forming side tanks where cargo tanks fitted are intended for the carriage of cargoes at a temperature  $-55\text{ }^{\circ}\text{C}$  and below.

**1.4** Arrangements ensuring a seal between a deck and cargo tanks shall be provided in places where cargo tanks get through the weather deck.

### **1.5 Accommodation, service and machinery spaces and control stations.**

**1.5.1** No accommodation space, service space or control station shall be located within the cargo area. The bulkhead of accommodation spaces, service spaces or control stations that face the cargo area shall be so located as to avoid the entry of gas from the hold space to such spaces through a single failure of a deck or bulkhead on a ship having a containment system requiring a secondary barrier.

**1.5.2** Entrances, air inlets and openings to accommodation spaces, service spaces, machinery spaces and control stations shall not face the cargo area. They shall be located on the end bulkhead not facing the cargo area or on the outboard side of the superstructure or deckhouse or on both at a distance of at least 4 % of the length ( $L$ ) of the ship but not less than 3 m from the end of the superstructure or deckhouse facing the cargo area. This distance, however, need not exceed 5 m.

**1.5.3** Windows and sidescuttles facing the cargo area and on the sides of the superstructures or deckhouses within the distance mentioned above shall be of the fixed (non-opening) type. Wheelhouse windows may be non-fixed and wheelhouse doors may be located within the above limits so long as they are designed in a manner that a rapid and efficient gas and vapour tightening of the wheelhouse can be ensured.

**1.5.4** For ships dedicated to the carriage of cargoes that have neither flammable nor toxic hazards, the Register may approve relaxations from the above requirements.

**1.5.5** Accesses to forecastle spaces containing sources of ignition may be permitted through a single door facing the cargo area, provided the doors are located outside hazardous areas as defined in 1.2.1 of Part VII "Electrical Equipment".

**1.5.6** Windows and sidescuttles facing the cargo area and on the sides of the superstructures and deckhouses shall comply with the requirements of 2.1.1 of Part V "Fire Protection".

**1.5.7** All air intakes, outlets and other openings into the accommodation spaces, service spaces and control stations shall be fitted with closing devices. When carrying toxic products, they shall be capable of being operated from inside the space. The requirement for fitting air intakes and openings with closing devices operated from inside the space for toxic products need not apply to spaces not normally manned, such as deck stores, forecastle stores, workshops. In addition, the requirement does not apply to cargo control rooms located within the cargo area.

---

<sup>1</sup> Hereinafter referred to as "the LG carriers".

<sup>2</sup> Hereinafter referred to as "the LG Rules".

**1.5.8** Control rooms and machinery spaces of turret systems may be located in the cargo area forward or aft of cargo tanks in ships with such installations. Access to such spaces containing sources of ignition may be permitted through doors facing the cargo area, provided the doors are located outside hazardous areas or access is through airlocks.

**1.6** Access from the open weather deck to non-hazardous areas shall be located outside the hazardous areas as defined in 1.2.1 of Part VII "Electrical Equipment", unless the access is by means of an airlock in accordance with [1.20](#) of this Part.

**1.7** Turret compartments shall be arranged with two independent means of access/egress.

**1.8** The design of a hold space shall ensure the visual inspection of insulation as viewed from the hold space.

Where insulation integrity can be checked by the visual inspection of the bulkhead, separating the hold space, at the operational temperature of a cargo tank, the insulation inspection from the hold space is not required.

**1.9** The visual inspection shall be ensured at least on one side of the inner hull structure without removal of some permanent structure or equipment.

Where such inspection is possible on the outside of the inner hull only, the inner hull shall not be a fuel-oil tank boundary wall.

**1.10** Arrangements for hold spaces, void spaces, cargo tanks and other spaces classified as hazardous areas, shall be such as to allow entry and inspection of any such space by personnel wearing protective clothing and breathing apparatus and shall also allow for the evacuation of injured and/or unconscious personnel.

**1.11** Access to all cargo tanks shall be direct from the weather deck.

**1.12** The dimensions providing access through horizontal openings, hatches or manholes shall be sufficient to allow a person wearing a breathing apparatus to ascend or descend any ladder without obstruction, and also to provide a clear opening to facilitate the hoisting of an injured person from the bottom of the space. The minimum clear opening shall be not less than 600×600 mm with an angular radius up to maximum 100 mm. To reduce the stresses in way of the radius, the opening may be increased up to 600×800 mm with the radius increased up to 300 mm ([refer to Fig. 1.12](#)).

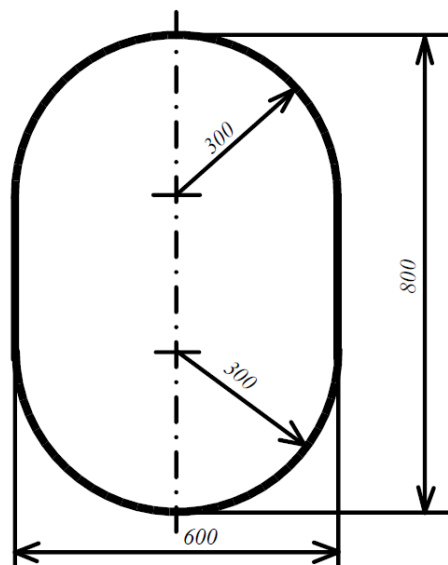

Fig. 1.12

**1.13** The minimum vertical openings or manholes providing passage through the length and breadth of the space shall be not less than 600×800 mm with an angular radius 300 mm. When due to the structural strength of girders in double bottom tanks an opening 800 mm in height is not allowed, the opening 600×800 mm may be used ([refer to Fig. 1.13](#)).

For impeded evacuation of an injured person on the stretchers, the vertical opening may be used not less than 850×620 mm ([refer to Fig. 1.13](#)) as an alternative to an opening 600×800 mm with an angular radius 300 mm.

When the vertical opening is located at a height more than 600 mm, gratings and footholds shall be provided. In this case impeded evacuation of an injured person shall be demonstrated.

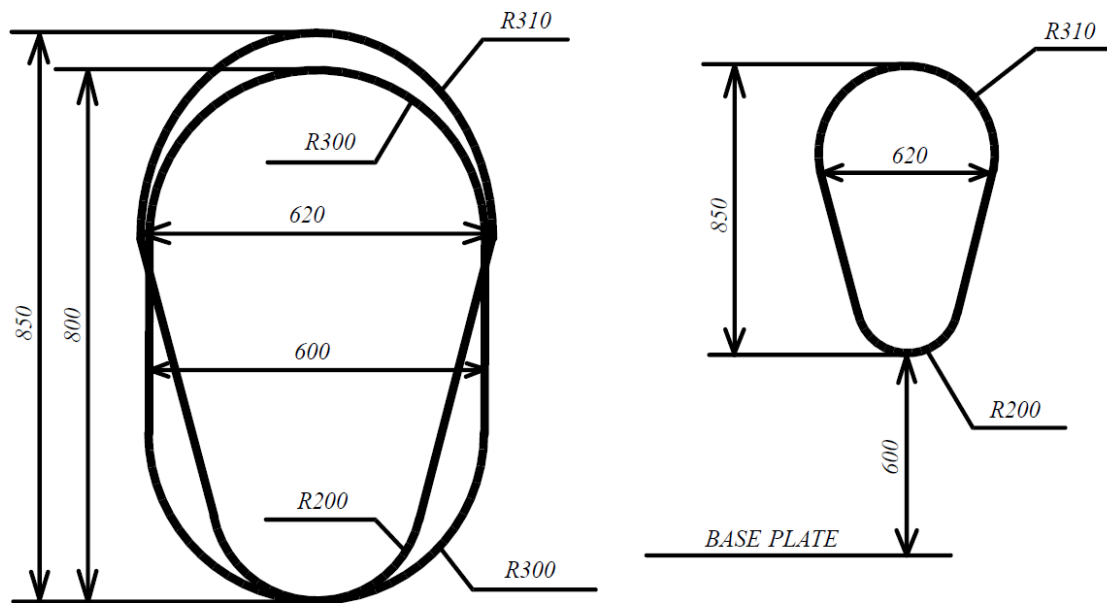

Fig. 1.13

**1.14** Circular access openings to type C tanks shall have a diameter of not less than 600 mm.

**1.15** The dimensions referred to in [1.12](#) and [1.13](#) may be decreased, if the requirements of [1.10](#) can be met to the satisfaction of the Administration.

**1.16** Where cargo is carried in a containment system requiring a secondary barrier, the requirements of [1.12](#) and [1.13](#) do not apply to spaces separated from a hold space by a single gastight steel boundary. Such spaces shall be provided only with direct or indirect access from the weather deck, not including any enclosed non-hazardous area.

**1.17** Access required for inspection shall be a designated access through structures below and above cargo tanks, which shall have at least the cross-sections as required by [1.13](#).

**1.18** For the purpose of [1.8](#) or [1.9](#), the following shall apply:

**.1** where it is required to pass between the surface to be inspected, flat or curved, and structures such as deck beams, stiffeners, frames, girders, etc., the distance between that surface and the free edge of the structural elements shall be at least 380 mm. The distance between the surface to be inspected and the surface to which the above structural elements are fitted, e.g. deck, bulkhead or shell, shall be at least 450 mm for a curved tank surface (e.g. for a type C tank), or 600 mm for a flat tank surface (e.g. for a type A tank) ([refer to Fig. 1.18.1](#));

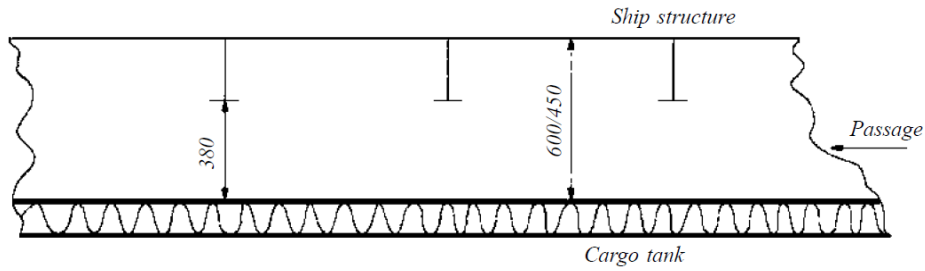

Fig. 1.18.1

.2 where it is not required to pass between the surface to be inspected and any part of the structure, for visibility reasons the distance between the free edge of that structural element and the surface to be inspected shall be at least 50 mm or half the breadth of the structure's face plate, whichever is the larger (refer to Fig. 1.18.2);

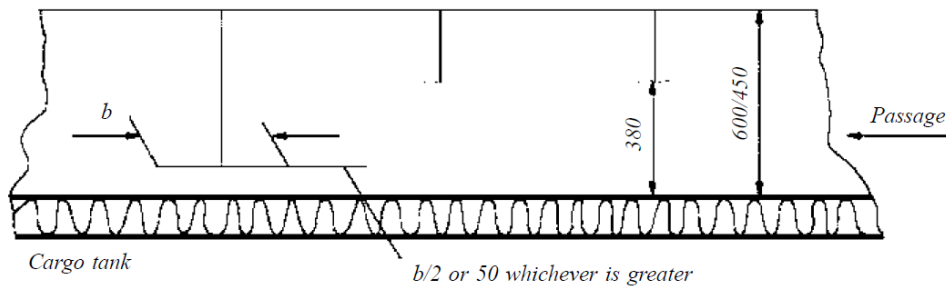

Fig. 1.18.2

.3 if for inspection of a curved surface where it is required to pass between that surface and another surface, flat or curved, to which no structural elements are fitted, the distance between both surfaces shall be at least 380 mm (refer to Fig. 1.18.3). Where it is not required to pass between that curved surface and another surface, a smaller distance than 380 mm may be accepted taking into account the shape of the curved surface;

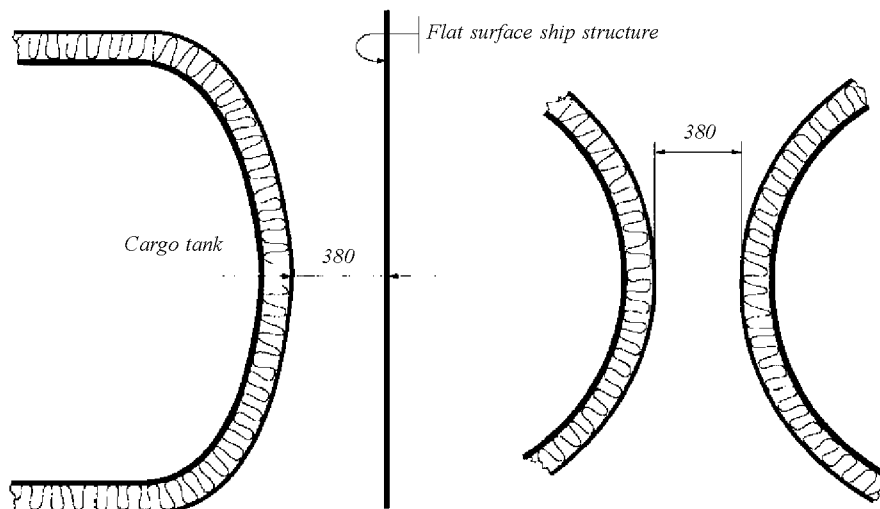

Fig. 1.18.3

.4 if for inspection of an approximately flat surface where it is required to pass between two approximately flat and approximately parallel surfaces, to which no structural elements are fitted, the distance between those surfaces shall be at least 600 mm. Where fixed access ladders are fitted, a clearance of at least 450 mm shall be provided for access ([refer to Fig. 1.18.4](#));

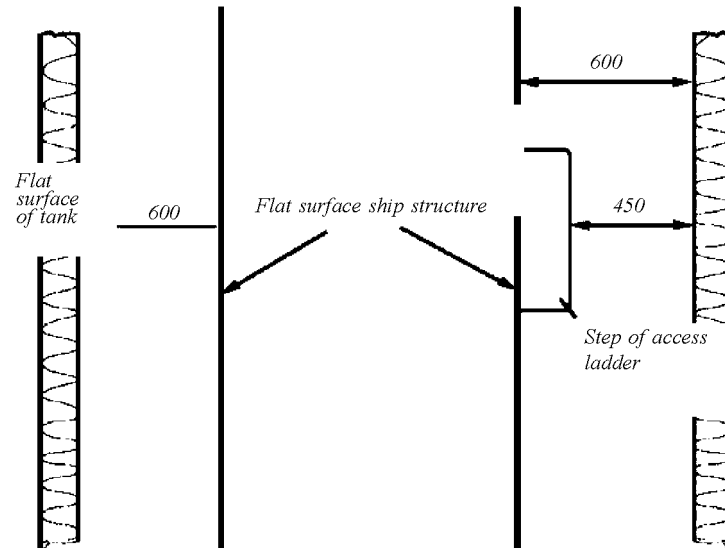

Fig. 1.18.4

.5 the minimum distances between a cargo tank sump and adjacent double bottom structure in way of a suction well shall not be less than those shown in [Fig. 1.18.5](#) (Fig. shows that the distance between the plane surfaces of the sump and the well is a minimum of 150 mm and that the clearance between the edge between the inner bottom plate, and the vertical side of the well and the knuckle point between the spherical or circular surface and sump of the tank is at least 380 mm). If there is no suction well, the distance between the cargo tank sump and the inner bottom shall not be less than 50 mm;

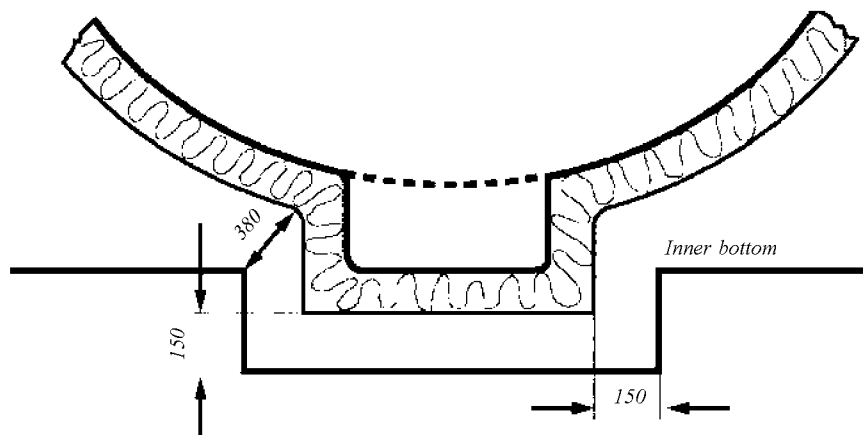

Fig. 1.18.5

**.6** the distance between a cargo tank dome and deck structures shall not be less than 150 mm ([refer to Fig. 1.18.6](#));

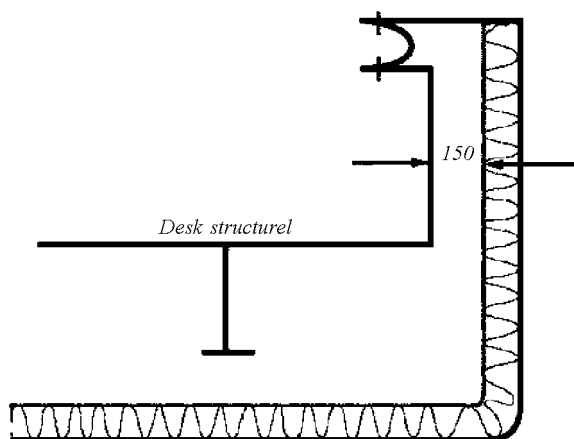

Fig. 1.18.6

**.7** fixed or portable staging shall be installed as necessary for inspection of cargo tanks, cargo tank supports and restraints (e.g. anti-pitching, anti-rolling and anti-flotation chocks), cargo tank insulation etc. This staging shall not impair the clearances specified in [1.18.1 — 1.18.4](#); and

**.8** if fixed or portable ventilation ducting shall be fitted, such ducting shall not impair the distances required under [1.18.1 — 1.18.4](#).

**1.19** Access to the space separated by a single gastight steel boundary from the hold space containing cargo tanks with a secondary barrier shall be provided from the open weather deck only.

**1.20** Access between hazardous area on the open weather deck and non-hazardous spaces shall be by means of an airlock. This shall consist of two self-closing, substantially gastight, steel doors, capable of maintaining the overpressure, at least 1,5 m but no more than 2,5 m apart. The airlock door sill shall not be less than 300 mm in height.

The airlock space shall be artificially ventilated from a non-hazardous area and maintained at an overpressure to the hazardous area on the weather deck.

Requirements for alarm, electrical equipment, ventilation and cargo vapour presence monitoring are specified in 8.3.3 of Part VI "Systems and Piping", in Part VII "Electrical Equipment" and in Section 6 of Part VIII "Instrumentation and Automation Systems".

For the purpose of application of the LG Rules, watertight doors may be considered gastight.

**1.21** Access through doors, gastight or otherwise, shall not be permitted from a non-hazardous area to a hazardous area except for access to service spaces forward of the cargo area through airlocks, as provided in [1.20](#), when accommodation spaces are aft.

**1.22** Pipe tunnels shall have at least two independent exits, leading to the open deck, arranged in opposite ends of the tunnel.

Exits in forward spaces or void spaces of the cargo area may be arranged in opposite ends of the tunnel. These exits shall be fitted with closures of the type approved by the Register.

**1.23** The dimensions and design of pipe tunnels shall make possible the unimpeded inspection and repair of piping, as well as the unimpeded evacuation of unconscious personnel in the event of injury.

**1.24** The design of covers for tank domes shall be approved by the Register.

**1.25** Arrangement of solid ballast in way of cargo tanks is generally not permitted. In special cases when taking in the solid ballast in way of cargo tanks is inevitable, this ballast shall be arranged so that impact loads in case of bottom damage are not transmitted directly to the cargo tanks.

## 2 STRUCTURAL PROTECTION TYPES. LOCATION OF CARGO TANKS

**2.1** The following standards of structural protection are provided for LG carriers.

**Type 1G** is the highest standard of structural protection in the transportation of products specified in the Table of Technical Requirements (refer to Annex 1) which are the most hazardous for the human and environment, and require maximum preventive measures to preclude the escape of such cargo.

**Type 2G** is a standard of structural protection in the transportation of less dangerous products specified in the Table of Technical Requirements (refer to Annex 1) which require significant preventive measures to preclude the escape of such cargo.

**Type 2PG** is a standard of structural protection for ships of 150 m in length and less in the transportation of dangerous products specified in the Table of Technical Requirements (refer to Annex 1) which require significant preventive measures to preclude the escape of such cargo, and where the products shall be carried in independent type C tanks designed for MARVS of at least 0,7 MPa gauge and a cargo containment system design temperature of  $-55\text{ }^{\circ}\text{C}$  or above. The ship meeting these requirements, but having over 150 m in length shall be considered a **type 2G** ship.

**Type 3G** is a standard of structural protection in the transportation of products specified in the Table of Technical Requirements (refer to Annex 1) which require moderate preventive measures to preclude the escape of such cargo.

**2.2** The type of structural protection required in the transportation of individual products is specified in the Table of Technical Requirements (refer to Annex 1).

**2.3** When several products with a different degree of hazard are carried, the requirements for ship's damage trim and stability shall correspond to those for ships carrying the most dangerous of products carried.

**2.4** Cargo tanks shall be located at the following distances inboard:

**.1 type 1G ships:** from the moulded line of the outer shell, not less than the transverse extent of damage specified in 3.2.1.2 of Part V "Subdivision" of the Rules for the Classification and, from the moulded line of the bottom shell at centreline, not less than the vertical extent of damage specified in 3.4.6.2 of Part V "Subdivision" of the Rules for the Classification, and nowhere less than  $d$  where  $d$  is as follows ([refer to Figs. 2.4.1-1](#) and [2.4.1-2](#) of this Part):

**.1.1** for below or equal  $1000\text{ m}^3$ :  $d = 0,8\text{ m}$ ;

**.1.2** for  $1000\text{ m}^3 < V_c < 5000\text{ m}^3$ :  $d = 0,75 + V_c \times 0,2/4000\text{ m}$ ;

**.1.3** for  $5000\text{ m}^3 \leq V_c < 30000\text{ m}^3$ :  $d = 0,8 + V_c/25000\text{ m}$ ; and

**.1.4** for  $V_c \geq 30000\text{ m}^3$ :  $d = 2\text{ m}$

where  $V_c$  corresponds to 100 % of the gross design volume of the individual cargo tank at  $20\text{ }^{\circ}\text{C}$ , including domes and appendages. For the purpose of cargo tank protective distances, the cargo tank volume is the aggregate volume of all the parts of tank that have a common bulkhead(s); and  $d$  is measured at any cross section at a right angle from the moulded line of outer shell.

Tank size limitations may apply to **type 1G** ship cargoes in accordance with Part X "Special Requirements" of the LG Rules;

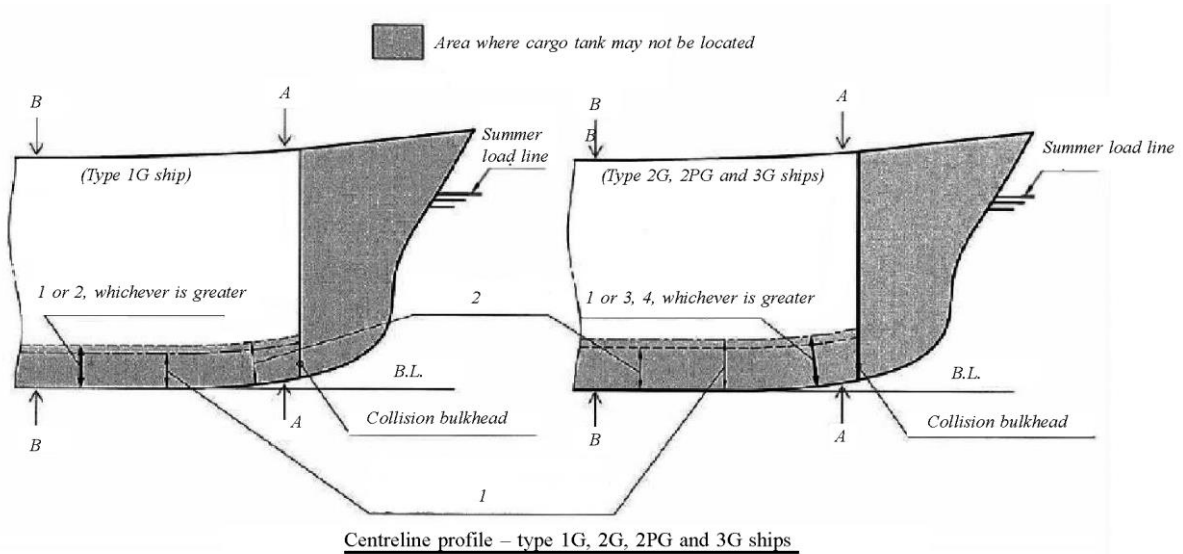

Fig. 2.4.1-1

Cargo tank location requirements for **type 1G, 2G, 2PG and 3G** ships:

- 1 — vertical extent of bottom damage specified in 3.4.6.2 of Part V "Subdivision" of the Rules for the Classification;
- 2 — distance  $d$  specified in 2.4.1.1 of Part II "Ship Arrangement" of the LG Rules;
- 3 — distance  $d$  specified in 2.4.1.2 of Part II "Ship Arrangement" of the LG Rules;
- 4 — distance  $d$  specified in 2.4.1.3 of Part II "Ship Arrangement" of the LG Rules;
- 5 — transverse extent measured in board of ship side specified in 3.2.1.2 of Part V "Subdivision" of the Rules for the Classification

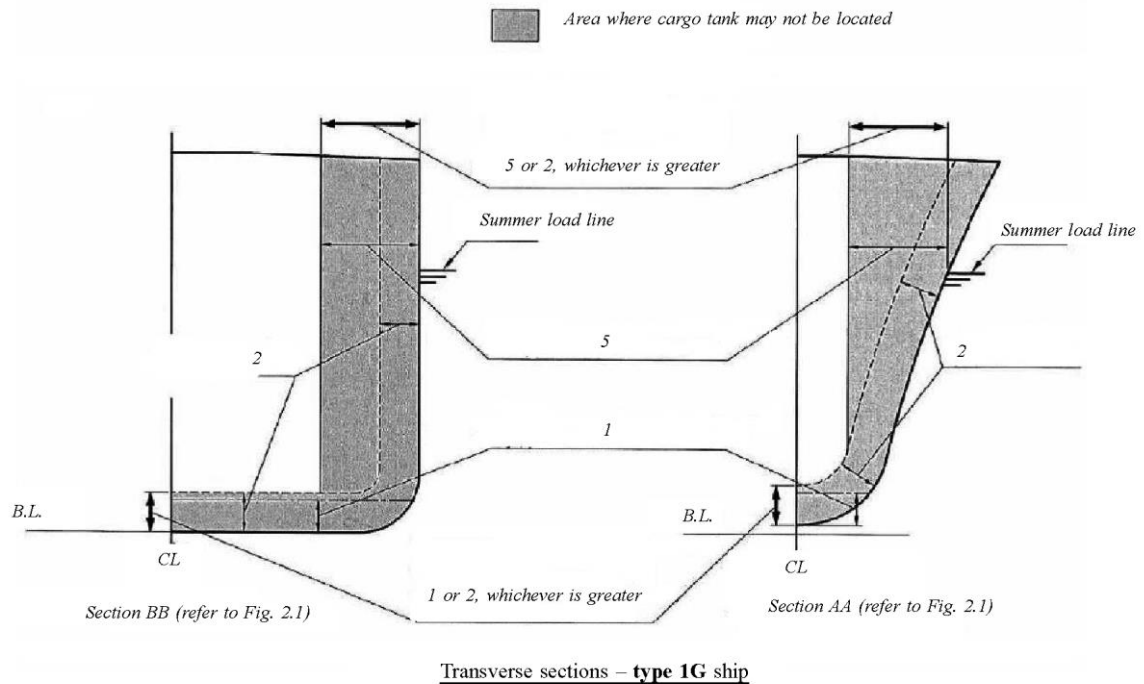

Fig. 2.4.1-2

Cargo tank location requirements for **type 1G** ships:

- 1 — 5 — [refer to Fig. 2.4.1-1](#)

.2 **types 2G/2PG**: from the moulded line of the bottom shell at centreline not less than the vertical extent of damage specified in 3.4.6.2 of Part V "Subdivision" of the Rules for the Classification, and nowhere less than  $d$  as indicated in [2.4.1.1](#) of this Part ([refer to Figs. 2.4.1-1 and 2.4.1-2](#));

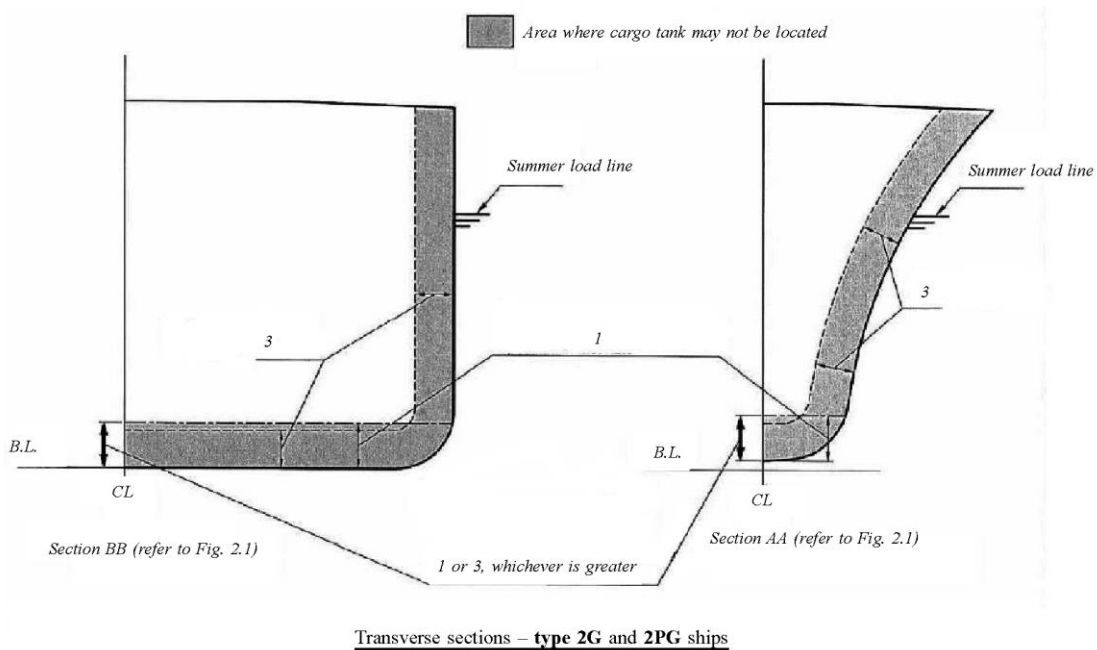

Fig. 2.4.2

Cargo tank location requirements for **type 2G** and **2PG** ships:

1, 3 — [refer to Fig. 2.4.1-1](#)

.3 **type 3G** ships: from the moulded line of the bottom shell at centreline not less than the vertical extent of damage specified in 3.4.6.2 of Part V "Subdivision" of the Rules for the Classification, and nowhere less than  $d$ , where  $d = 0,8$  m from the moulded line of outer shell ([refer to Figs. 2.4.1-1 and 2.4-3](#) of this Part).

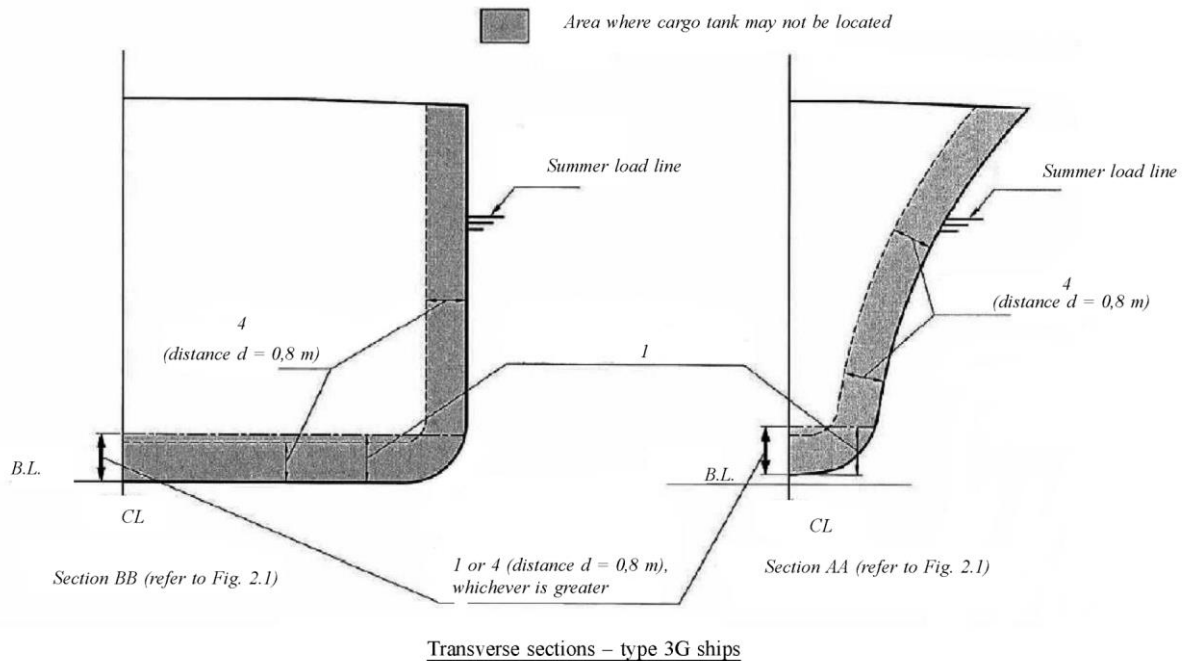

Fig. 2.4.3

Cargo tank location requirements for **type 3G** ships:

1, 4 — [refer to Fig. 2.4.1-1](#)

**2.5** For the purpose of tank location, the vertical extent of bottom damage shall be measured to the inner bottom when membrane or semi-membrane tanks are used, otherwise to the bottom of the cargo tanks.

The transverse extent of side damage shall be measured to the longitudinal bulkhead when membrane or semimembrane tanks are used, otherwise to the side of the cargo tanks.

The distances indicated in [2.4](#) shall be applied as in [Figs. 2.5-1 — 2.5-5](#). These distances shall be measured plate to plate, from the moulded line to the moulded line, excluding insulation.

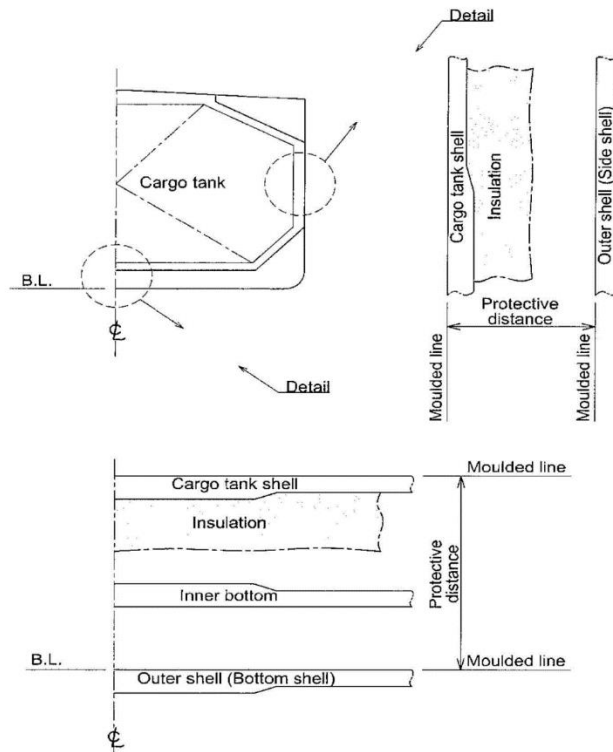

Fig. 2.5-1  
Protective distance to independent prismatic tank

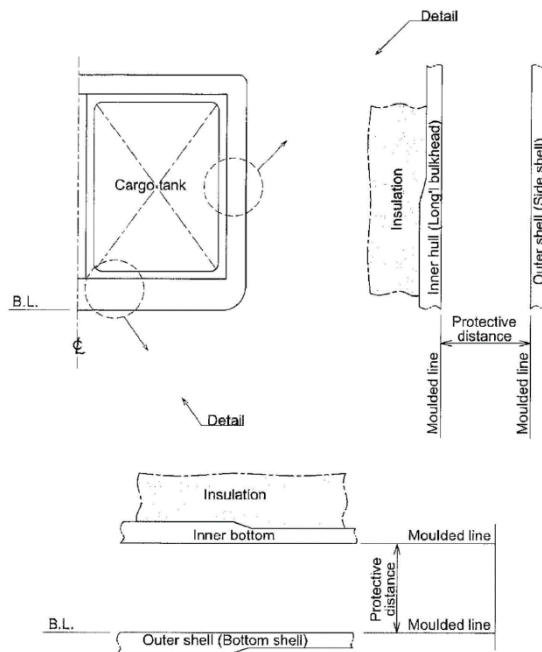

Fig. 2.5-2  
Protective distance to semi-membrane tank

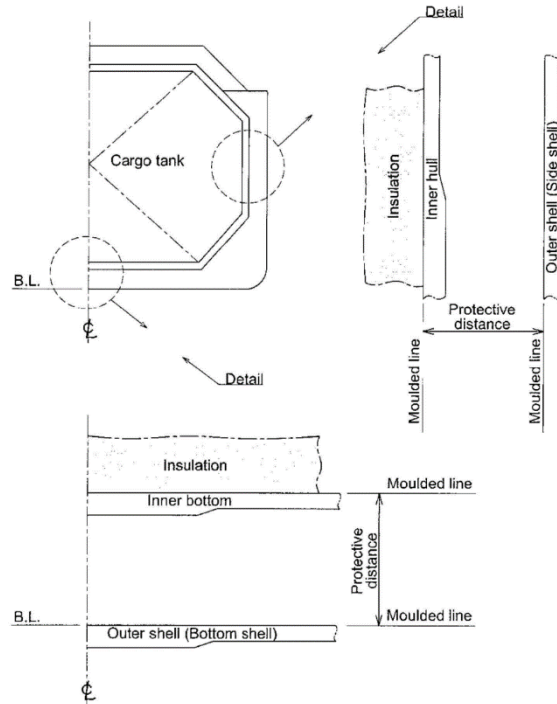

Fig. 2.5-3  
Protective distance to membrane tank

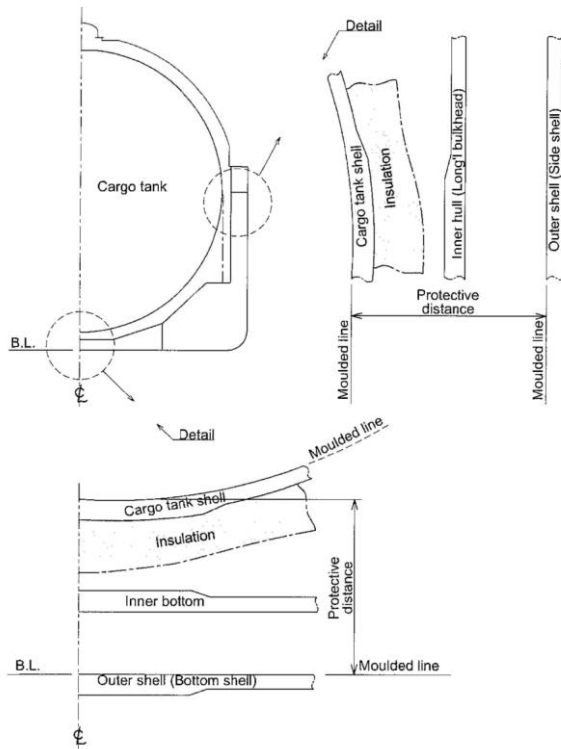

Fig. 2.5-4  
Protective distance to spherical tank

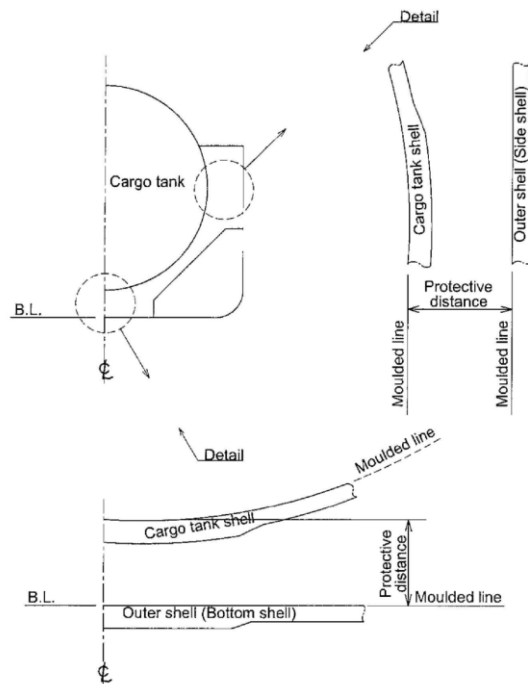

Fig. 2.5-5  
Protective distance to pressure type tank

**2.6** Cargo tanks shall not be located forward of the collision bulkhead.

**2.7** Except the ships carrying products, which require the **type 1G** structural protection, suction wells of cargo tanks may protrude into the vertical extent of bottom damage, but their protrusion below the inner bottom plating shall not exceed 25 % of the double bottom depth or 350 mm, whichever is less. The wells meeting this requirement are ignored in determining the number of compartments flooded.

**2.8** The location requirements may be applied separately to each cargo tank depending on the degree of hazard of the product carried in it.

**2.9** The position of the moulded line for different containment systems is shown in [Figs. 2.5-1 — 2.5-5](#).

### **3 HULL**

**3.1** Dimensions of hull structural members are determined in accordance with the requirements for tankers and bulkers of the Rules for the Classification depending on the actual ship's structures arrangement and cargo tanks type.

**3.2** The requirements for the design and dimensions of cofferdams are specified in 2.7 of Part II "Hull" of the Rules for the Classification.

#### **3.3 Selection of materials.**

**3.3.1** Design temperature of hull structures in cargo area is determined by calculating temperatures in accordance with 19.2.1 of Part IV "Cargo Containment" of the LG Rules for cargo and ambient temperature values applied for the project. Approximate determination of design temperature of hull structure in accordance with 1.2.3.4 of Part II "Hull" of the Rules for the Classification is not permitted.

**3.3.2** If design temperature of ship's shell plating and deck structure, as well as framing members connected thereto, is below  $-5\text{ }^{\circ}\text{C}$ , material shall be in accordance with the current version of IACS Unified Requirement (UR) S6 (refer to IACS official webpage [www.iacs.org.uk](http://www.iacs.org.uk)).

If design temperature of hull structure supporting the cargo tanks, inner bottom plating, longitudinal bulkhead plating, transverse bulkhead plating, floors, webs, stringers and all attached stiffening members is below  $0\text{ }^{\circ}\text{C}$ , material shall be in accordance with the requirements of Table 2.1-5 of Part IX "Materials and Welding" of the LG Rules (refer also to 19.2.3 of Part IV "Cargo Containment" of the LG Rules).

In other cases, grade of steel for hull structures shall be in accordance with the current version of IACS UR S6 (refer to IACS official webpage [www.iacs.org.uk](http://www.iacs.org.uk)).

**3.3.3** For hull structures outside the cargo area, material shall be in accordance with the current version of IACS UR S6 (refer to IACS official webpage [www.iacs.org.uk](http://www.iacs.org.uk)).

#### **3.4 Testing.**

Testing procedures of watertight compartments of a gas carrier shall comply with the requirements of Part A of Appendix 1 to Part II "Hull" of the Rules for the Classification.

Additional requirements for testing of hull structures in the cargo area are specified in Part IV "Cargo Containment" of the LG Rules for respective cargo tank types.

Russian Maritime Register of Shipping

**Rules for the Classification and Construction  
of Ships Carrying Liquefied Gases in Bulk  
Part II  
Ship Arrangement**

FAI "Russian Maritime Register of Shipping"  
8, Dvortsovaya Naberezhnaya,  
191186, St. Petersburg,  
Russian Federation  
[www.rs-class.org/en/](http://www.rs-class.org/en/)