

RULES

FOR THE CLASSIFICATION AND CONSTRUCTION OF MOBILE OFFSHORE DRILLING UNITS

PART XIII WELDING

ND No. 2-020201-026-E



St. Petersburg

RULES FOR THE CLASSIFICATION AND CONSTRUCTION OF MOBILE OFFSHORE DRILLING UNITS

The present version of Part XIII "Welding" of the Rules for the Classification and Construction of Mobile Offshore Drilling Units in Bulk of Russian Maritime Register of Shipping (RS, the Register) has been approved in accordance with the established approval procedure and comes into force on 1 July 2024.

The present version is based on the version dated 1 September 2023 and Rule Change Notice No. 24-83043 taking into account the amendments and additions developed immediately before publication (refer to the Revision History).

REVISION HISTORY¹

For this version, there are no amendments to be included in the Revision History.

¹ With the exception of amendments and additions introduced by Rule Change Notices (RCN), as well as of misprints and omissions.

1 GENERAL

1.1 APPLICATION

1.1.1 The requirements of this Part of the Rules for the Classification and Construction of Mobile Offshore Drilling Units¹ apply to welding of MODU structural elements, subject to the Register technical supervision, and supplement the requirements of Part XIV "Welding" of the Rules for the Classification and Construction of Sea-Going Ships².

1.1.2 The welded joints shall be executed in accordance with provisions of 1.3, Part XIV "Welding" of the RS Rules/C and these Rules following the approved by the Register technical documents and/or standards agreed with the Register.

¹ Hereinafter referred to as "the MODU Rules".

² Hereinafter referred to as "the RS Rules/C".

1.2 DEFINITIONS AND EXPLANATIONS

1.2.1 The definitions and explanations related to the general terminology are given in Part XIV "Welding" of the RS Rules/C.

1.2.2 For the purpose of this Part the following definitions have been adopted.

Production tests are the tests, including destructive tests, which are based on welding of specimens obtained directly in the course of product manufacture and subjected to the same treatment, as the actual products. Besides, depending on particular conditions and possibilities, the specimens may be cut out of extra lengths (allowances) of structures or be manufactured in conditions identical with those of product manufacture and using the same WPS.

Welding procedure tests are the tests conducted under technical supervision and within the scope of the Register requirements to confirm the capability of the manufacturer to carry out welding of particular structures; the tests closely simulate actual working conditions and are performed in accordance with the WPS requirements.

Welding procedure qualification record (WPQR) is the Register documents containing complete information on testing for approval of welding procedure. WPQR includes the following forms (records) Details of Weld Test and Test Results.

Pre-production welding tests are the tests for approval of welding procedure based on the use of non-standard specimens and samples and simulating welding in actual production conditions.

Welding Procedure Approval Test Certificate is a Register document certifying that the welding procedure applied at the shipyard or firm (manufacturer of welded structures) has passed the tests and is approved by the Register for application.

Welding Procedure Specification (WPS) is a document compiled by the manufacturer of welded structures and containing all the necessary information on welding of a particular joint, including specification for materials, welding method, edge preparation data and all process parameters.

Note. WPS based on the previous welding experience and recommendations of welding consumables and base metal manufacturers, but having no confirmation and approval, is called "preliminary WPS" (pWPS). Welding of specimens for approval of welding procedure is carried out in accordance with the preliminary WPS.

1.3 SCOPE OF TECHNICAL SUPERVISION

1.3.1 For welding operations in construction of MODU the scope of technical supervision by the Register is determined in accordance with 1.4.2, Part XIV "Welding" of the RS Rules/C, taking into account the requirements of this Part.

1.4 TECHNICAL DOCUMENTATION

1.4.1 The technical documentation on welding to be submitted for approval of the project of MODU construction as a whole is specified in Section 4, Part I "Classification" of the MODU Rules. The technical documentation on structures which are subject to the Register technical supervision shall contain information on welding within the scope of requirements formulated in the parts of these Rules covering the structures mentioned above.

2 PROCESS REQUIREMENTS FOR MANUFACTURE OF MODU WELDED STRUCTURES

2.1 GENERAL

2.1.1 All firms (shipyards, manufacturers of welded structures, welding facilities), which perform operations in welding of structures under the Register technical supervision, shall prove the readiness to carry out work of the required level of complexity and to guarantee in full scope the compliance with requirements of the Register specified in this Part.

2.1.2 The readiness to carry out the welding operations means providing the welding facilities with all the required equipment, jigs and fixtures, availability of an internal quality control system, the adequate personnel qualification, as well as meeting the requirements of the Register approval for welding procedure employed.

2.1.3 The firms shall guarantee, through regular internal checks and inspections in the course of product manufacture and after completion of welding operations, that all the work is done in full compliance with the requirements of the MODU Rules.

2.1.4 In case the firm employs for intended work outside subcontractors or casual workers, the responsibility for meeting the requirements concerning the production control lies, in accordance with [2.1.3](#), with the prime contractor.

2.1.5 In the general case, the requirements in quality control to be guaranteed by the firm include checking of the following factors:

- .1** base metal;
- .2** welding consumables;
- .3** edge preparation and assembling for welding;
- .4** conditions of storage and procedure for issue of welding consumables;
- .5** compliance of the conditions of work in assembly and welding with the requirements of the Welding Procedure Specification;
- .6** compliance of the welding and thermal treatment technology with the requirements of the Welding Procedure Specification;
- .7** compliance of welded joint dimensions with the requirements of design documentation;
- .8** acceptance testing and testing of welded joints and structures, as well as procedure for repair of revealed defects;
- .9** compliance of the welders' qualification with the nature and complexity of the work to be done.

2.1.6 The firms shall grant to the RS surveyors free access for performance of all necessary checks and surveys in the course of technical supervision during manufacture of welded structures.

In case the quality of welding operations does not meet all the established requirements, the RS surveyor shall notify the firm to take measures to eliminate the factors adversely affecting the quality of production or, where necessary, to stop the work.

2.2 WELDING PROCEDURES

2.2.1 General.

2.2.1.1 For welding of structures subject to the Register technical supervision, only welding procedures and techniques may be used warranting high stability of guaranteed quality of welded joints that may be confirmed by the welded structures manufacturer by approval testing or other techniques in accordance with [2.2.2](#).

2.2.1.2 The document, which identifies unambiguously the welding procedures employed by the manufacturer, is the Welding Procedure Specification (of the manufacturer) – WPS.

2.2.1.3 The consideration and approval by the Register of welding procedure is stipulated by the requirements of this Part.

2.2.1.4 The welding procedure used by the manufacturer shall be approved for application by the Register. Such permission is certified by a document stating that the welding procedure has passed the approval procedure: this is Welding Procedure Approval Test Certificate.

2.2.2 Approval of welding procedures.

2.2.2.1 The principal type of approval for welding procedures is conduction of approval tests. The approval tests may be standard, and the requirements for them are established in Section 6, Part III "Technical Supervision during Manufacture of Materials" of the Rules for Technical Supervision during Construction of Ships and Manufacture of Materials and Products for Ships¹, or they can be pre-production, before starting the production.

At the same time the pre-production tests conducted before starting the production shall be carried out observing the following main requirements:

.1 welding of samples shall be carried out in conditions which are as close as possible to welding of actual structures, with simulation of integrated effect of the factors influencing the quality of weld metal;

.2 in welding of samples the assembly fixtures, devices, positioners, etc. shall be similar to those used in production;

.3 the tack welds, if necessary, shall be tested as parts of the completed joint;

.4 the scope of sample checking includes visual testing, surface cracks testing (magnetic particle or penetrant testing), hardness testing, testing of macrosections as well as some types of destructive testing according to documentation agreed by the Register;

.5 the region of approval with respect to thickness of base metal and of employed welded joints is limited, as a rule, by thickness of particular assemblies simulated by the conducted tests.

2.2.2.2 Production tests are carried out in cases when there are some doubts about product quality stability, or changes in process parameters are suspected, or when the standard and preliminary tests are insufficient for a particular welding procedure. Such welding procedures, which are distinctive in higher degree of probability of deviations in quality of welded joints, include:

.1 vertical - downward welding;

.2 one-side welding with free back-forming of weld root using coated electrodes or flux-cored wire;

.3 welding process with high heat input (electroslag welding, electroslag welding, etc.);

.4 welding process extra-sensitive to assembly and edge preparation quality, such as electron beam and laser welding.

2.2.2.3 Approval of the welding procedures at a particular firm is permitted on the basis of the previous experience of work with welding of similar structures without conduction of tests. This way of approval cannot be used for welding of special structures, for welding of

¹ Hereinafter referred to as "the Rules TSDCS"

high-strength steels and steels of high cold resistance, also for welding procedures requiring preliminary or in-process tests.

2.2.2.4 Qualification testing for approval of welding procedures of steels with "Arc" index shall be supplemented by the weld metal crack resistance parameter (*CTOD*) testing. The tests are carried out in accordance with 2.2.10.5, Part XIII "Materials" of the RS Rules/C for the Classification and 6.7.4, Part III "Technical Supervision during Manufacture of Materials" of the Rules TSDCS, according to the programs approved by the Register.

2.3 PRODUCTION PERSONNEL. QUALIFICATION OF WELDERS

2.3.1 All operations in welding of structures of MODU subject to the Register technical supervision shall be carried out by qualified welders only, who have passed the required tests and have valid Welder Approval Test Certificates issued by the Register in accordance with the requirements of Section 5, Part XIV "Welding" of the RS Rules/C.

The nature and complexity of work performed by welders in working conditions shall be in full compliance with the area of approval indicated in the Welder Approval Test Certificates.

In case of admittance to work of welders having qualification certificates issued by other authorities, including classification societies, the following requirements shall be met:

.1 equivalency of scope and quality of qualification tests conducted for welders' certification to requirements of Section 5, Part XIV "Welding" of the RS Rules/C;

.2 compliance of the admittance granting procedure with the requirements of Section 5, Part XIV "Welding" of the RS Rules/C (experience and interruption in work, age, etc.);

.3 compliance with the range of approval established in accordance with the requirements of Section 5, Part XIV "Welding" of the RS Rules/C depending on the scope of practical tests at certification.

2.3.2 Each production department dealing with welding work shall have in its staff a responsible person, a surveyor engaged in direct supervision of proper observation of the requirements for welding operations in accordance with the documentation approved by the Register.

As a rule, the production welding supervisor shall have a qualification of a diploma engineer in welding. Among his duties is informing the RS surveyor of any changes in the welding procedure and of all deviations, if any of them took place in execution of welding operations.

The welding supervisor is personally responsible for timely and efficient execution of the following activities and control operations:

.1 drafting of WPS and approval of welding procedure;

.2 control of welders' qualifications conformity with the requirement of the Register;

.3 incoming control of base metal and welding consumables;

.4 observation of conditions of welding consumables storage and issue, of its conformity with established requirements;

.5 edge preparation and assembly for welding;

.6 maintenance of the welding equipment, jigs and fixtures in proper technical condition;

.7 monitoring of welding operations to detect any deviations from the WPS;

.8 monitoring and analysis of welded joints quality on the basis of in-process and acceptance testing;

.9 control and monitoring of work in repair of defects in lengths of welded joints.

2.4 BASE METAL. WELDABILITY

2.4.1 The materials employed in manufacture of welded structures of MODU subject to the Register technical supervision shall fully comply with the relevant requirements of Part XIII "Materials" of the RS Rules/C for the Classification and Part XII "Materials" of the MODU Rules.

The weldability of base metal is considered approved in the course of testing aimed at approval of the base metal and recognition of the manufacturer by the Register.

Given below are general requirements stipulating the necessity for additional weldability tests, as employed in specific conditions of welded structures manufacture at firms.

2.4.2 The additional weldability tests are conducted in the scope of testing for approval of welding procedure and normally include:

.1 determination of heat affected zone properties for actual product manufacture cycle (in most cases it can be achieved using standard samples, as specified in Section 6, Part III "Technical Supervision during Manufacture of Materials" of the Rules TSDCS;

.2 confirmation of the welded joint resistance to cold cracking for specific conditions of welding operations (as a rule, this requires the use of nonstandard, so-called "technological" or "laboratory" samples taken in the course of preliminary approval tests).

2.4.3 The necessity to conduct additional weldability tests is established by the requirements of this section, as well as Section 6, Part III "Technical Supervision during Manufacture of Materials" of the Rules TSDCS and in general cases it is substantiated by the following factors:

.1 application of special welding methods, for instance, those requiring high heat input, which are not included into the normal range of approval on the basis of weldability test results;

.2 special requirements for weld and heat affected zone properties, such as defined by the results of crack resistance tests (*CTOD*);

.3 application of base metals highly sensitive to particular features of welding procedure (including high-strength steels, microalloyed cold-resistant steels, high-alloyed steels of complex structure, etc.);

.4 welding in unfavourable conditions;

.5 deviations from the requirements of this Section (for example, from preheating temperature);

.6 heat treatment after welding.

2.5 WELDING CONSUMABLES

2.5.1 The welding consumables employed in welding of structural elements of MODU subject to the Register technical supervision shall be approved by the Register in accordance with the requirements of Section 4, Part XIV "Welding" of the RS Rules/C. At the same time, the use of welding consumables shall comply with instructions contained in their Type Approval Certificate, as well as requirements listed below.

2.5.2 In general cases, the employed welding consumables shall ensure equivalence of characteristics of welded joints and base metal quality.

The ultimate breaking strength of a welded joint shall not be below the ultimate breaking strength of steel employed for manufacture of the given structural element.

For the weld and heat affected zone metal the values of impact and test temperature shall comply with the requirements for welded joint serviceability.

2.5.3 The electrodes, combinations "wire-flux" and "wire-gas" intended for welding of special and primary structures made of higher- and high-strength steels shall ensure the content of diffusible hydrogen in the deposited metal corresponding to indices H10 or H5. Only electrodes with basic coating shall be used for the purpose.

For welding of secondary steel structures with thickness up to 20 mm not subjected to dynamic loads the electrodes with rutile coating may be used.

2.5.4 Selection of grade of welding consumables for welding of structures of normal and higher strength steels.

The welding consumables shall be used for welding of steel of those grades for which they were approved by the Register in accordance with [Table 2.5.4](#). At that, it is necessary to be guided by the following requirements:

.1 when producing welded joints where a steel of normal strength is welded with a steel of higher strength welding consumables can be used which correspond to the lowest grade permissible according to requirements of [Table 2.5.4](#) for each steel taken separately (for instance, in a welded joint involving steels of grades D and E32 welding consumables of grade 3 may be used);

.2 when producing welded joints where steels of the same strength levels are welded, but with different requirements concerning impact bending test temperature, welding consumables can be used which correspond to the lowest grade permissible according to [Table 2.5.4](#) for each steel taken separately, except for steel of grade E40 (for instance, in a welded joint involving steels of grades D32 and E32 welding consumables of grade 3Y can be used);

.3 when producing welded joints where steels of higher strength are welded, also when a higher strength steel is welded with normal strength steel, welding consumables with controlled content of diffusible hydrogen, as specified in Table 4.2.3.4, Part XIV "Welding" of the RS Rules/C for the Classification, shall be used. But only electrodes with basic coating are permissible;

.4 for welding of normal strength steels (grades A, B, D, E) welding consumables approved for corresponding steel grades A40, D40, E40 and/or F40 may only be used for particular grades of welding consumables in case the satisfactory results are provided of the necessary tests conducted according to the program approved by the Register;

.5 use of grade IY welding consumables for welding of higher strength steels is allowed only for joints with thickness up to 25 mm inclusive;

.6 welding consumables selected from [Table 2.5.4](#) can be also specified for welding of other steels, besides those covered by the Table, if such steels in their mechanical properties and chemical composition are equivalent to steels for which the particular welding consumable has been approved;

.7 rutile-type electrodes may be used for welding of secondary structures from normal strength steel with thicknesses up to 20 mm and not subjected to dynamic loads;

.8 electrodes with oxide type coating are not permitted for use in construction of MODU.

Table 2.5.4

Grade of welding consumables	Shipbuilding steel									
	normal strength				higher strength steel					
	A	B	D	E	A32, A36	D32, D36	E32, E36	A40	D40	E40
I, IS, IT, IM, ITM, IV	+	-	-	-	-	-	-	-	-	-
IY, IYS, IYT, IYM, IYTM, IYV	+	-	-	-	+ ¹	-	-	-	-	-
2, 2S, 2T, 2M, 2TM, 2V	+	+	-	-	-	-	-	-	-	-
2Y, 2YS, 2YT, 2YM, 2YTM, 2YV	+	+	-	-	+	-	-	-	-	-
2Y40, 2Y40S, 2Y40T, 2Y40M, 2Y40TM, 2Y40V	Refer to 2.5.4.4				+	-	-	+	-	-
3,3S, 3T, 3M, 3TM, 3V	+	+	+	-	-	-	-	-	-	-
3Y, 3YS, 3YT, 3YM, 3YTM, 3YV	+	+	+	-	+	+	-	-	-	-
3Y40, 3Y40S, 3Y40T, 3Y40M, 3Y40TM, 3Y40V	Refer to 2.5.4.4				+	+	-	+	+	-
4Y, 4YS, 4YT, 4YM, 4YTM, 4YV	+	+	+	+	+	+	+	-	-	-
4Y40, 4Y40S, 4Y40T, 4Y40M, 4Y40TM, 4Y40V	Refer to 2.5.4.4				+	+	+	+	+	+

¹ Refer to [2.5.4.5](#).

2.5.5 Selection of welding consumable grade for welding of high-strength steel structures.

The welding consumables shall be used for welding of high-strength steels of grades, for which they are approved by the Register, as specified by [Tables 2.5.5-1](#) and [2.5.5-2](#).

In selection of grades the following limitations and requirements shall be kept in mind:

.1 the scope of application of the particular welding consumable grade has the following limitations for welding of the base metal depending on its strength level as specified in [Table 2.5.5-2](#);

scope of application of welding consumables approved for strength levels Y42, Y46 and Y50 may cover the welding of steels in the two strength levels below that for which they have been approved;

scope of application of welding consumables approved for strength levels Y55, Y62 and Y69 may cover the welding of steels in the one strength level below that for which they have been approved;

scope of application of welding consumables approved for strength level Y89 may cover the welding of steels in the same strength level;

scope of application of welding consumables approved for strength level Y96 may cover the welding of steels in the one strength level below that for which they have been approved;

.2 when joining high strength steel to the same and also joining high strength steel to higher or normal strength steels, it is necessary to apply welding consumables with controlled content of diffusible hydrogen and having classification indices H5 or H10 in accordance with Table 4.2.3.4, Part XIV "Welding" of the RS Rules/C;

.3 it is not recommended to use a single-run and two-run welding for joints in high-strength steels. They may only be approved on the basis of additional tests conducted according to the program approved by the Register;

.4 it is not recommended to use electrogas and electroslag welding technologies for joints in high-strength steels. They may only be approved on the basis of additional tests conducted according to the program approved by the Register;

.5 it is not recommended to use multi-arc and one-side welding with various types of backing for joints in high-strength steels. They may only be approved on the basis of additional tests conducted according to the program approved by the Register;

.6 electrodes with rutile and iron oxide type of coating shall not be applied for welding of high-strength steel structures;

.7 application of welding consumables of all grades subjected to testing within the scope specified in 4.6, Part XIV "Welding" of the RS Rules/C, for welding of high-strength steels is only possible for joints with base metal thickness not exceeding 70 mm. Use of welding consumables for welding of steels exceeding 70 mm in thickness may be permitted on the basis of additional tests conducted according to the program approved by the Register.

Table 2.5.5-1

Identification of grades of welding consumables by test temperature	Identification of grades of high-strength steels by impact bend test temperature			
	A(420/960)	D(420/960)	E(420/960)	F(420/690)
3Y(42/96)	+	+	-	-
4Y(42/96)	+	+	+	-
5Y(42/96)	+	+	+	+

Table 2.5.5-2

Identification of welding consumables grades by strength level	Identification of higher and high strength and steel grades by strength level									
	(A/F) 36	(A/F) 40	(A/F) 420	(A/F) 460	(A/F) 500	(A/F) 550	(A/F) 620	(A/F) 690	(A/E) 890	(A/E) 960
(3Y/5Y)42	+	+	+	-	-	-	-	-	-	-
(3Y/5Y)46	-	+	+	+	-	-	-	-	-	-
(3Y/5Y)50	-	-	+	+	+	-	-	-	-	-
(3Y/5Y)55	-	-	-	-	+	+	-	-	-	-
(3Y/5Y)62	-	-	-	-	-	+	+	-	-	-
(3Y/5Y)69	-	-	-	-	-	-	+	+	-	-
(3Y/4Y)89	-	-	-	-	-	-	-	-	+	-
(3Y/4Y)96	-	-	-	-	-	-	-	-	+	+

2.5.6 Selection of welding consumable grade for welding of shipbuilding steel structures operating at low temperatures.

Welding consumables for welding of structures of shipbuilding steel grades F32, F36 and F40 operating at low temperatures shall be used in accordance with requirements of [Table 2.5.6](#). The welded joints where the higher strength steel with the index F is welded to the steels of other grades, the grade of welding consumables shall be selected according to the requirements of [2.5.4](#).

Table 2.5.6

Welding consumable grade	Shipbuilding steel grade		
	F32	F36	F40
5Y, 5YS, 5YT, 5YTM, 5YV	+	+	-
5Y40, 5Y40S, 5Y40T, 5Y40M, 5Y40TM, 5Y40V	+	+	+
5Y42, 5Y42S, 5Y42M	-	+	+
5Y46, 5Y46S, 5Y46M	-	+ ¹	+

¹ Use of welding consumables of grade 5Y46 intended for welding of high-strength steels shall be agreed upon additionally with the Register.

2.6 TYPES OF WELDS IN WELDED JOINTS

2.6.1 Butt joints.

2.6.1.1 Depending on the thickness of elements to be joined, method and spatial position of welding and ease of access for welding, the butt joints can be produced without edge preparation, with single-sided or double-sided (symmetrical or asymmetrical) groove, as required by national standards. In cases when the designer or manufacturer of welded structures selects a non-standard form of edge preparation and design dimensions of the welded joint, these shall be indicated separately in the drawings and in the specification for welding operations.

The shape of welds and details of edge preparation for special welding techniques (for instance, single-sided welding on copper slides, gas electric or electroslag welding) shall be approved by the Register individually on the basis of welding procedure test results.

2.6.1.2 Butt welded joints are executed, as a rule, with full penetration in a technological process including operations of weld root dressing and back welding. Other techniques of one-side welding can be used, which permit to omit operations of weld root dressing and backing. All parameters of such one-side welding procedure shall be minutely confirmed by approval testing. The scope of testing and quantity of samples in such cases shall be agreed upon additionally by the Register.

2.6.1.3 If the requirements and recommendations mentioned in [2.6.1.2](#) cannot be satisfied (for example, in case of single-sided access to the weld), it is permissible to make single-sided butt joints on the permanent backing or single-sided lock joints. In this case the value of root gap shall be specified to ensure the guaranteed penetration and absence of defects, it is recommended to decrease the angle of bevel in comparison with ordinarily employed values.

The given type of joint shall not be used in special structures, and as for primary structures, the possibility of its use is subject to consideration by the Register, taking into account the requirements to ensure the fatigue strength.

2.6.1.4 The recommended forms of edge preparation for butt joints in clad steels are shown in [Fig. 2.6.1.4](#).

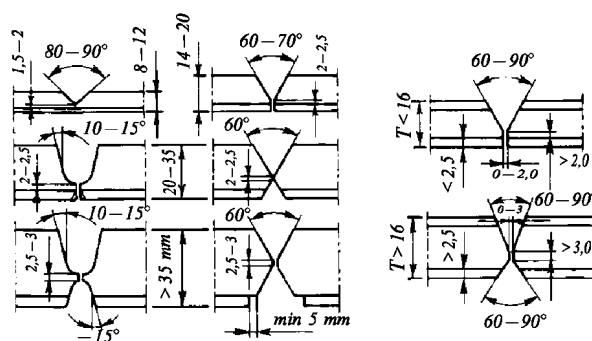

Fig. 2.6.1.4

2.6.2 Corner, T- and cruciform joints with guaranteed full penetration.

2.6.2.1 Depending on thickness of members to be joined, welding process, spatial position, as well as ease of access, corner, T- and cruciform joints with guaranteed full penetration are effected with single or double bevel edge preparation. Structural elements of edge preparation and dimensions of welds are selected in accordance with the requirements of national standards for relative welding process. If non-standard forms of edge preparation

or special requirements for weld shape are stipulated, they shall be indicated separately in the drawings and in the specification for welding operations.

2.6.2.2 As a rule, welds with guaranteed full penetration require weld root dressing and back welding. For welding techniques allowing to omit these operations (electrodes for root weld backing, various types of flexible backups, etc.) all parameters of the technology, including design elements of edge preparation, are subject to separate confirmation by means of approval testing of welding procedure.

2.6.2.3 If a corner joint shall be flush (without extended free edge), for equivalent joints of special members a double (asymmetrical) bevel shall be selected, as shown in [Fig. 2.6.2.3-1](#). At the same time, to prevent lamellar fracture of the base metal the bevel angle shall be increased in the direction away from the theoretical line of plate alignment.

Similar edge preparation shall be used in T-type erection joints (or cruciform joints without extension of the continuous plate), where the element abutting at an angle is placed between the adjoining elements (refer to [Fig. 2.6.2.3-2](#)).

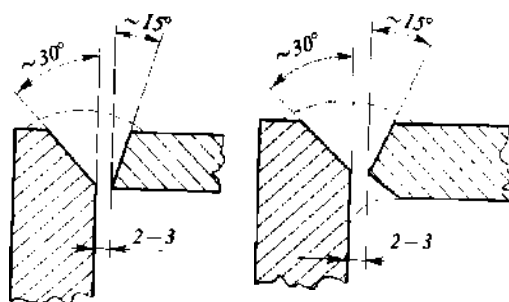

Fig. 2.6.2.3-1

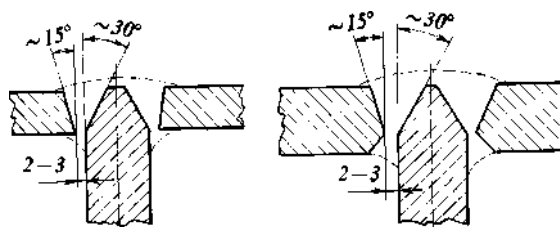

Fig. 2.6.2.3-2

2.6.2.4 Corner, T- and cruciform joints which have access for welding from one side only can be prepared with single bevel on the permanent backing. In this case the limitations and recommendations listed in [2.6.1.3](#) shall be taken into consideration.

2.6.3 Corner, T- and cruciform joints with non-guaranteed full penetration.

2.6.3.1 This type of welded joints in the shape of edge preparation is identical to joints mentioned in [2.6.2](#) but differing from them by presence of permissible incomplete root penetration f of the welded joint (refer to [Fig. 2.6.3.1](#)). The technology of making joints with non-guaranteed penetration does not include the operation of root dressing before back welding, which could result in incomplete root penetration.

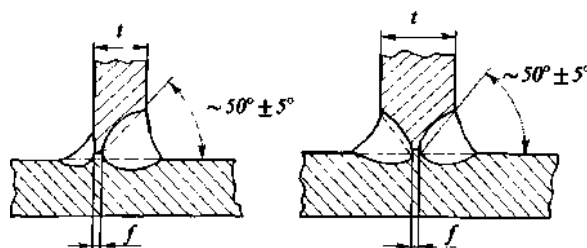

Fig. 2.6.3.1

Examples of double-sided T-joint with full non-guaranteed penetration for single and double bevel at the abutting plate

2.6.3.2 In normal practice incomplete root penetration of weld root is limited to value of $f \leq 0,2t$ (not exceeding 3 mm), where t is the thickness of abutting plate (with edge preparation). The effective thickness of the weld in this case shall be taken equal to the thickness t of the abutting plate, and the incomplete root penetration f shall be compensated by additional increase in height of welds a by a value not lower than f for each side of the joint.

2.6.3.3 The joints with non-guaranteed full penetration shall not be used in special structures, and as for primary structures, the possibility of use in them is subject to consideration by the Register, with due regard to the fatigue strength requirements. In any case, the issue of application in a structure of joints with non-guaranteed full penetration can be accepted for review by the Register only if the manufacturer can submit confirmed guarantees, that value f was properly tested by non-destructive methods both in the process of manufacture and at the acceptance of the joints.

2.6.3.4 The single-sided joints with non-guaranteed full penetration and without back welding (refer to [Fig. 2.6.3.4](#)) shall not be used in special and primary structures (members). The issue of the possibility of such joints use in secondary structures shall be reviewed by the Register, as specified in [2.6.3.3](#).

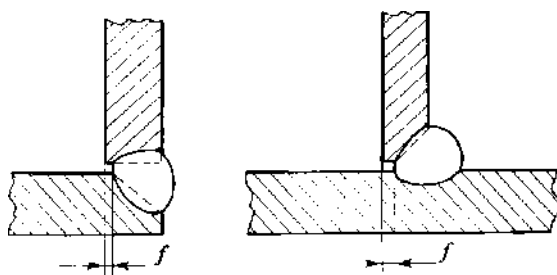

Fig. 2.6.3.4

Examples of single-bevel corner and T-joints with non-guaranteed full penetration

Note. This limitation has no force for joints completed with the use of specialized welding process and welding consumables intended for single-sided welding. Incomplete root penetration in this case is called shrinkage of single-sided weld and its value is normally limited to $f \leq 0,05t$ but shall not exceed 1,0 mm (simultaneously limitations are introduced in the extent of a single defect and in summary length of defects per 1 m of weld).

2.6.4 Corner, T- and cruciform joints with edge preparation and designed lack of fusion.

2.6.4.1 Joints with designed lack of fusion (refer to [Fig. 2.6.4.1](#)) have a specific feature: the edge bevel covers only a part of the abutting plate thickness. As a result of this, in the weld

root after completion of welding a lack of fusion appears with nominal value $d = c + f$ where c is the value of designed lack of root penetration in the weld root taken to be equal to the value of root face; f is the value of permissible incomplete root penetration in the weld root resulting from omitted operations of dressing and back welding.

The structural elements of edge preparation, weld dimensions and joint characteristics c , d and f shall be indicated in the drawings and in the specification for welding operations (an example is given in [Fig. 2.6.4.1](#)).

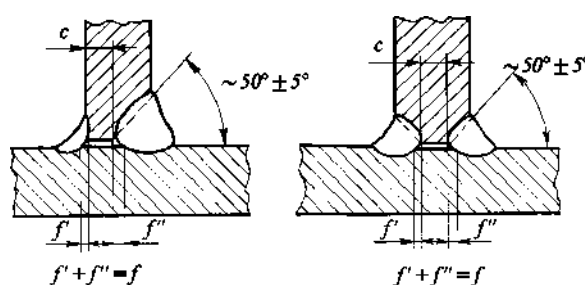

Fig. 2.6.4.1

Examples of double-bevel T-joints with designed lack of fusion

2.6.4.2 Incomplete root penetration of the weld root is limited by value $f \leq 0,02t$, but it shall not exceed 3,0 mm, and the value of c shall not, as a rule, exceed $1/3 t$. For the given type of joints the effective thickness of weld shall be taken equal to the thickness of the abutting plate t minus nominal incomplete root penetration $d = c + f$.

2.6.4.3 Application of joints with designed lack of fusion is limited to double-sided type and shall be approved by the Register.

Another limitation is the use of such joints only in the primary and secondary structures not subjected to considerable dynamic and fatigue loads. The manufacturer shall guarantee, by means of proper acceptance testing, the compliance of actual and design values of parameter d , as well as acceptable level of defects in weld cross-section.

2.6.5 Fillet welded joints executed by fillet welding without edge preparation.

2.6.5.1 The joints achieved by fillet welding without edge preparation shall be employed in structures double-sided version.

Design height of fillet welds shall be determined in accordance with 1.7, Part II "Hull" of the RS Rules/C.

2.6.5.2 Depending on the penetration in the fillet weld root two types of joint are differentiated: with normal and with deep penetration. In the latter case penetration of the weld metal into the base metal is much deeper than the theoretical point of weld root (refer to [Fig. 2.6.5.2](#)) which fact, in meeting of certain requirements, may be taken into account in calculation of the fillet weld height a .

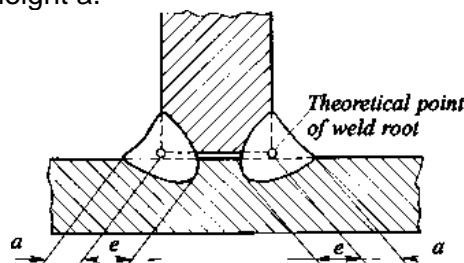

Fig. 2.6.5.2

Fillet joint formed with double-sided fillet welding with deep penetration

2.6.5.3 Application and approval of welding procedure ensuring formation of fillet welds with deep penetration shall be agreed with the Register.

In case of successful results of tests for approval of welding procedure the Register may permit to define the design value of thickness a_d of a fillet weld with deep penetration using equation (refer to [Fig. 2.6.5.2](#))

$$a_d = a + 2e_{min}/3 \quad (2.6.5.3)$$

where a = design height of fillet weld defined by weld reinforcement dimensions (counting from the theoretical point of the root);
 e_{min} = minimum penetration depth established individually on the basis of tests for approval of welding procedure.

2.6.5.4 Permissible deviations from the theoretical shape and design dimensions of fillet welds shall correspond to the requirements of national standards or other regulating documents and shall be indicated in the documentation on welding to be approved by the Register.

2.7 WELDING OF HULLS AND EQUIPMENT OF MODU

2.7.1 Requirements for preparation of joints for welding.

2.7.1.1 Workpieces for assembly of joints to be welded shall be properly machined, straightened and shall have unambiguous identification in accordance with the requirements of technical documentation on manufacture of welded structures.

2.7.1.2 The applied cutting techniques and equipment shall ensure compliance of dimensions and surface finish of parts prepared for welding with the requirements stated in the documentation approved by the Register.

2.7.1.3 Additional dressing of edges and surfaces of parts to be welded by mechanical techniques after thermal cutting or for removal of protective coatings shall be carried out prior to assembling in cases when it is stipulated in the Welding Procedure Specification, in accordance with the requirements of this Section and also of the technical documentation on manufacture of welded structures.

2.7.1.4 Surfaces of parts and structures to be welded shall be clean and dry. The mill scale, rust, dross remaining after thermal cutting, burrs, oils, paint and dirt shall be carefully removed prior to welding.

The quality of cleaning of the edges for welding shall be controlled and approved by the authorized representative of the manufacturer.

2.7.1.5 It is permissible to carry out welding of steel parts coated with protective shop primer without removal of the latter, if the following requirements are satisfied:

.1 the shop primer has been subjected to appropriate tests and has been approved for application by the Register;

.2 the manufacturer using a protective shop primer shall guarantee and confirm by control checks the fact that the primer application conditions stated in the Type Approval Certificate remain valid, and in welding (especially fillet welding) there is no excessive pore formation affecting negatively the quality of welds;

.3 there are no additional limitations for application of protective primers not removed before welding according to the requirements of this Chapter or documentation approved by the Register.

Note. The control checks performed in the course of manufacture of structures shall include measuring of coating thickness on witnessing specimens, also welding of T-joints for evaluation of the tendency to pore-formation by fracture testing.

2.7.1.6 The gap between the joint of parts assembled for welding shall correspond to regulating requirements (tolerances) indicated in the Welding Procedure Specification and/or technical documentation approved by the Register.

In butt welded joints between parts which differ in thickness more than 4 mm provision shall be made for single- or double-bevel at the edge of the larger thickness part with the slope: not less than 1:4 — for parts subjected to fatigue loads; not less than 1:3 — for the rest structures.

2.7.1.7 It is allowed, with preliminary permission of the RS surveyor, to correct too large gaps by deposition, if the deviation from the acceptable rated value of the gap (excluding the tolerance) does not exceed the lowest thickness of the abutting elements and is not higher than 10 mm. Correction of the unacceptable gaps by deposition is allowed at a length not exceeding 500 mm per 1 m of weld and the total length of corrected areas shall not exceed 30 % of the length of technologically self-dependent welded joint. When the length of joint is less than 500 mm the deposition may be made over the whole length of the joint.

Notes: 1. The lengths corrected by deposition shall be accepted by an authorized representative of the firm and after that submitted to the RS surveyor.

2. In case of semiautomatic and manual welding it is permissible to use, instead of deposition over the whole width of the edge, single beads ("crests"). In a T-joint deposition may be made to any of the matching parts.

3. In case of automatic welding and fully mechanized welding techniques the joint lengths corrected by deposition shall be dressed with grinding wheel or machined with cutting tools to fully restore the initial shape of edge preparation.

2.7.1.8 The welded edges corrected by deposition in accordance with directions of [2.7.1.7](#) shall be checked by visual testing and, if necessary, by suitable methods of non-destructive testing. In this case the RS surveyor may specify additional lengths for welded joints testing in places with gaps corrected by deposition.

2.7.1.9 In places, where large gaps have been corrected by deposition, the width of weld reinforcement or fillet weld calibre shall be increased by the summary height of deposit, with the reinforcement height remaining the same. The deposit height at the edge end face shall be measured parallel to the part surface.

2.7.1.10 The gaps, which exceed several times the dimensions given in [2.7.1.7](#), may be corrected by welding - in a strip of plate with width of at least 10 times larger than the thickness of parts to be joined but not less than 300 mm (refer to [Fig. 2.7.1.10 \(c\)](#)) according to the procedure agreed with the Register.

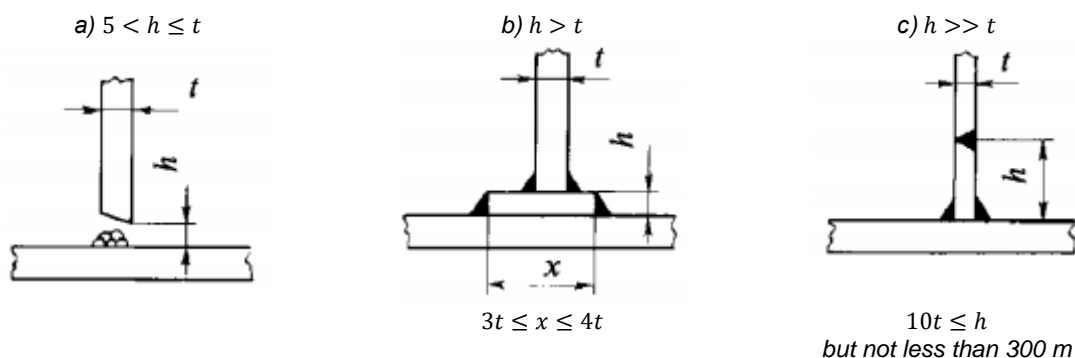

Fig. 2.7.1.10

Patterns for elimination of inadmissible gaps in T-joints:

a) by deposition; b) by insertion of compensating strip; c) by welding-in of additional strip.

For special members correction of too large gaps by using versions [Fig. 2.7.1.10 \(b\)](#) and [\(c\)](#) is not permitted.

Note. For T-joints made by fillet welding without edge preparation (calibre), when the gap size is only slightly larger than the value indicated in [2.7.1.7](#), the correction of the gap may be done by welding onto the main part of a compensating lap strip with width $3t \leq x \leq t$, where t is the thickness of the butting part (refer to [Fig. 2.7.1.10 \(b\)](#)).

2.7.1.11 When assembling structures to be welded special attention shall be given to ensuring the planeness of the structures and alignment of the joint edges to be welded.



Fig. 2.7.1.11-1

Acceptable misalignment of parts in butt welded joints:

$$\begin{aligned}
 e &\leq 0,1t_{min}, \text{ but not more than 4 mm for special structures;} \\
 e &\leq 0,15t_{min}, \text{ but not more than 4 mm for primary structures;} \\
 e &\leq 0,30t_{min}, \text{ but not more than 4 mm for secondary structures;} \\
 t_{min} &= \min(t_1 \text{ and } t_2)
 \end{aligned}$$

It is considered acceptable for butt welded joints to have root misalignment e (or misalignment of part edges, when there is no edge preparation) in compliance with requirements of [Fig. 2.7.11-1](#).

For cruciform joints the acceptable misalignment of parts to be joined shall correspond to values indicated in [Fig. 2.7.1.11-2](#). For control of alignment it is permitted to drill control holes in transverse members, which shall be welded over afterwards.

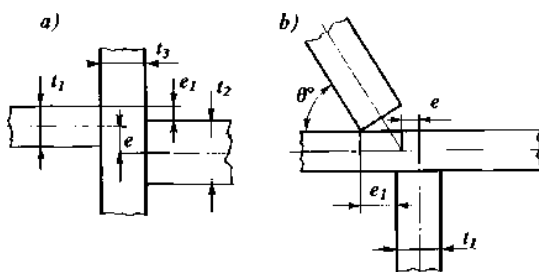

Fig. 2.7.1.11-2

Acceptable misalignment of parts in cruciform welded joints:

$$\begin{aligned}
 e &\leq 0,15t_{min} - \text{for special structures;} \\
 e &\leq 0,30t_{min} - \text{for primary structures;} \\
 e &\leq 0,50t_{min} - \text{for secondary structures;} \\
 t_{min} &= \min(t_1, t_2 \text{ and } t_3)
 \end{aligned}$$

2.7.1.12 When assembling the structures for welding the parts shall be fastened in special assembly jigs or with the use of elastic fasteners (thread chasers, cramps, turnbuckles, etc.), or with rigid fasteners (tack welds).

The use of temporary assembly jigs and tack welding shall be limited to minimum. The work in mounting of temporary assembly jigs and tack welding shall be performed by workers specially trained for the task and having a certificate of approval for the required welding techniques.

Note. In cases, when the assembly tack welds shall not be removed and are not fully remelted in the principal weld (for instance, in manual welding with coated electrodes or in semiautomatic gas-shielded welding), the requirements for qualification of workers performing the tack welding in welded joints with full penetration are similar to requirements for welders approved by the Register.

2.7.1.13 The work in mounting of temporary assembly jigs and in tack welding shall be carried out using the welding consumables approved by the Register for welding of the structures in question. The conditions of welding operations (such as preheating or drying of edges), as well as welding duties shall correspond to requirements of relevant Welding Procedure Specifications for similar structures.

Note. For tack welding on special and primary structures of higher strength steels it is recommended and for structures of high-strength steels it is mandatory to have Welding Procedure Specifications for such operations with approval by the Register according to the established procedure.

2.7.1.14 In the joints assembled for welding the tack welds shall not be placed on the side of backing.

At intersections of welds the tacks shall not be located at a distance less than 50 mm from the weld completed first.

It is not permitted to mount temporary fastening and leveling jigs on the surface of parts and braces subjected to high stresses (special structures and areas of structural stress concentration in primary structures). For this case it is recommended to use mechanical clamps and other fixtures not requiring tack welding.

2.7.1.15 The tack welds shall be cleaned from slag, metal splatter, examined visually. If the quality of tack welds does not satisfy the requirements for joints to be welded, the tacks shall be removed before execution of the principal weld. Tack welds with cracks are in no case be retained for subsequent welding and shall be removed without fail.

Note. In cases when the tacks are fully remelted in the course of principal weld formation (for instance, in case of automatic submerged arc welding), also in double-sided welding of butt or tee joints in which the weld root is subjected to gouging on the tack side (refer to [2.7.1.14](#)), some non-dangerous defects may be permitted in the tack weld metal, such as extra porosity or cuts.

2.7.1.16 In automatic submerged arc welding of butt joints, also in the use of other welding processes highly susceptible to formation of crater and other defects at the beginning and at the end of the weld outlet bars shall be used preventing damage to base metal, as required by [2.7.4.11](#).

2.7.1.17 Structures and products assembled for welding shall be checked and accepted by the manufacturer's technical control services, after which submitted to the RS surveyor for survey.

2.7.1.18 Before welding of thick plate structures, especially those manufactured of alloyed high-strength steels, with closed section, it is recommended to check the presence of magnetic fields. For normal welding procedure the magnetic intensity shall not exceed 790 A/m for manual arc welding, 950 A/m for semi-automatic gas-shielded arc welding and 1400 A/m for automatic submerged arc welding. Structures with magnetic intensity exceeding the above values shall be subjected to demagnetization.

2.7.1.19 After completion of welding the temporary fastening and leveling fixtures shall be removed by methods excluding damage to base metal. In case of cuts-through and other damages to the base metal resulting from removal of temporary fastening fixtures they shall be eliminated by welding-up and grinding, providing smooth transition to the base metal.

The decrease or increase in thickness of the base metal after grinding shall not exceed the permissible deviations in plate thickness specified in 3.2.8, Part XIII "Materials" of the RS Rules/C.

Note. Subject to complete removal with subsequent dressing to base metal are remains of the fastening fixtures welds on special and primary structures. On other structures the tack welds up to 10 mm in height may be left without dressing, if the latter is not specified in the technical documentation.

2.7.2 Welding in open-air sites and at low temperatures.

2.7.2.1 Welding of structures shall be performed, whenever possible, at indoor premises heated in winter time. If it is necessary to carry out such work in open sites, measures shall be taken to protect the welding zone against wind, moisture and cold.

In gas-shielded arc welding special attention shall be given to protection of gas shielding against wind and draughts. As a rule, reliable gas shielding may be ensured, if the velocity of air flows in the welding zone does not exceed 0,5 m/s.

2.7.2.2 When working in the open air under unfavorable weather conditions it is highly recommended to dry the edges to be welded by preheating.

2.7.2.3 If the welding of structures is performed at sub-zero temperatures, measures shall be taken which will guarantee satisfactory quality of welds. Such measures, depending on the type of welded metal, its thickness and other factors (refer to [2.7.2.5](#)) may include:

- .1 checking and cleaning of edges to be welded from snow, hoar-frost and ice;
- .2 drying of edges to be welded by heating to at least 20 °C;
- .3 local preheating of edges to be welded before starting of welding;
- .4 use of heat insulation devices;
- .5 use of techniques ensuring higher temperature between runs in the process of welding (such as execution of one weld by several welders simultaneously, in the so-called block method, etc.).

Selection of particular techniques for welding at sub-zero temperature is made by the manufacturer and is agreed with the Register in the course of welding procedure approval.

2.7.2.4 On condition proper quality of welded joints is ensured, welding and all related operations on the structures subject to technical supervision by the Register made of hull structural steel of normal and higher strength 20 mm in thickness are generally permitted at ambient temperature up to – 25 °C. For specific conditions, the minimum permissible ambient temperature for unheated welding shall be agreed with the Register at approving welding procedures. Preheating of the edges of parts to be welded shall be carried out at ambient temperature below –5 °C for normal strength steels and below 0 °C for higher strength steels. For high strength steels, preheating of the edges of parts to be welded shall be carried out at ambient temperature specified in [Table 2.8.16](#).

For steel forgings and castings of the MODU hull, welding may, as a rule, be carried out at the ambient temperature up to –15 °C.

The edges of parts to be welded shall be preheated at least to 20 °C over a width of 100 mm to both sides of the weld.

To be preheated is the side of the joint to be welded first.

If during welding the ambient temperature drops below the minimum permissible value, the welding shall be stopped after filling in the groove on one side of the joint and making the back sealing run or the first run on the other side. Prior to welding renewal after the stop, reheating or redrying of the edges shall be performed, where necessary.

2.7.2.5 If in the course of welding the temperature falls below the value indicated in [2.7.2.4](#) the work in welding of joints shall be stopped after filling of the gap on one side of the joint and completion of a backing weld or the first seam on the other side of the joint. Prior to welding after a break in the work, a repeated heating or edge drying shall be carried out, if necessary, in compliance with the requirements of [2.7.2.3](#) and [2.7.2.4](#).

2.7.2.6 Thermal gouging and tack welding shall be carried out at the same air temperatures, which are permissible for welding of the above structures.

2.7.3 Preheating and heat treatment.

2.7.3.1 The necessity of and temperature of preheating before welding, as well as minimum temperature between runs shall be specified taking into account the following main factors:

- .1 chemical composition of base metal and weld metal;
- .2 thickness of parts to be welded and type of joint;
- .3 welding process and conditions (heat input);
- .4 level and distribution of working and residual stresses in the structure;
- .5 dependence of weld metal and heat affected zone properties on temperature;
- .6 content of diffusive hydrogen in weld metal.

2.7.3.2 In welding of shipbuilding steels of higher and high strength grades up to (A/F) 550 inclusive the preheating may be effected by local heating up to the required part edge temperature at a width of 100 mm on both sides of the weld.

For high-strength structural steels of strength grades from (A/F) 620 to (A/F) 690 inclusive, especially at thicknesses above 50 mm, the method of preheating and method of maintaining the minimum temperature between runs are specified individually and shall be agreed with the Register in each particular case. In so doing, for massive products with large amount of welding operations the Register may require general preheating for the whole part.

2.7.3.3 If the procedure of welding operations envisages the use of preheating and control of temperature between runs, their parameters shall be kept constant by appropriate means, the temperature shall be monitored and recorded in the process of welding operation. The instruments employed for temperature measurements shall ensure the required accuracy.

2.7.3.4 In welding of hull structures the heat treatment after welding shall be used when it is necessary to eliminate residual stresses. The heat treatment conditions are specified by the manufacturer of welded structures or by the designer on the basis of standards taking into account the recommendations or limitations of the base metal manufacturers. The Register approves the suggested heat treatment conditions on the basis of tests conducted for approval of welding procedure.

2.7.3.5 The equipment and technical facilities employed for heat treatment of structures shall ensure uniform heating and shall be provided with instruments regulating the speed of heating and cooling of the workpiece, for maintaining the temperature within the specified limits. The parameters of heat treatment for each product shall be properly controlled and recorded.

2.7.3.6 If the dimensions of the structure are too large to heat treatment the latter as a whole, it can be heat treated in parts in separate chambers. The technical facilities and procedure for heat treatment shall be approved by the Register.

2.7.4 General requirements for welding operations.

2.7.4.1 The welding of structures and other products shall be carried out in accordance with the requirements of the drawings and relevant Welding Procedure Specifications approved by the Register.

2.7.4.2 In designing and manufacturing of welded structures a possibility shall be provided for welding in optimum spatial positions from the point of view of quality and ease of access.

2.7.4.3 Welding procedure used in production, as well as procedure control and monitoring, shall ensure high stability of the quality of welded joints in actual production conditions. To achieve this, the Register may require from the manufacturer of welded structures additional proofs of stability of welded joints quality for the procedures with higher degree of risk (refer to [2.2.2.2](#)). As such proofs, the results of in-process may be used, also additional lengths of welded joints may be assigned for non-destructive testing, as required by the RS surveyor.

2.7.4.4 For especially critical structures (special members, also primary structures, as selected by agreement with the designer and the Register) the monitoring at the firm shall include per each welded joint recording of the following information:

- .1 identification of technologically self-contained welded joint with value of its extent;
- .2 WPS identification No.;
- .3 working No. (certificate) of welder;
- .4 identification of personnel taking part in acceptance testing at all stages of manufacture and with all testing methods;
- .5 data on discrepancies between assembly and welding quality and requirements of regulating documents, also on performed corrections;
- .6 acceptance testing results with indication of test record Nos.

2.7.4.5 The assembly and welding procedure shall be worked out in such a way, as to minimize, as far as possible, angular strains, buckling of structures, also residual stresses.

When it is necessary to weld plates, sheets, etc., into a rigid contour some technological measures shall be taken to reduce stresses caused by welding. The rigid contour is a cutout with closed perimeter, one of the dimensions of which is less than 60 thicknesses of plates in a particular place. In complicated structures the contour can be considered rigid even at larger proportions of cutout dimensions.

2.7.4.6 Structures and parts shall not be displaced or subjected to vibration in the course of welding. Sections to be assembled afloat or suspended from cranes shall be fixed reliably in temporary assembly jigs or fastened by tack welds to exclude the possibility of their displacements during welding.

2.7.4.7 Straightening of structures is only permissible within a limited scope. Shipbuilding steels of normal and higher strength can be subjected to thermal straightening with mechanical action or without it. No damage to weld or plate surface is allowed. The temperature of heating in thermal straightening shall not exceed 650 °C, but in any case the heating shall not cause structural transformations in the metal.

2.7.4.8 Weld root adjustment in welded joints with full penetration, may be done by thermal gas gouging, electric arc (gas-arc) gouging, also by mechanical method, meeting the requirements listed below.

After thermal gas gouging the surface of the groove and adjoining surfaces at a width of 100 mm to both sides from the part edge in the joint shall be cleaned of slag, mill scale, metal rolls and sparks. The surface of the groove shall be clean and smooth, free from sharp changes in depth and width over the whole length of the joint.

After electric arc gouging the surface of the groove and electrode closing spots shall be dressed to bare metal. Dressing of surfaces of grooves formed in the course of gouging and surfaces adjacent to them, as well as places of electrode contacting with metal, shall be performed with the use of abrasive tools. Acceptance of gouged surfaces may be made using reference specimens with appropriate external appearance.

The shape of edge preparation after removal of the weld root shall be such as specified in the acting regulating documents, or as shown in the drawings, and/ or required by the Welding Procedure Specification.

The thermal gouging shall be performed at the same air temperatures as those admissible for welding of the parts in question, meeting the relevant requirements for use of preheating.

2.7.4.9 The automatic submerged-arc welding (wire plus flux) is employed for joints in downhand positions. The permitted angle of joint slope towards the horizon is up to 8° along the weld and up to 15° across the weld.

For welding techniques allowing to carry out welding in various spatial positions the electrode diameter shall satisfy the recommendations and/or limitations of the welding consumables manufacturer for specific conditions of their application.

2.7.4.10 Before starting automatic or semi-automatic arc welding of structures or products, the welding conditions stipulated by the procedure in accordance with the WPS, shall be checked on test bars. The thickness of test bars shall correspond to the minimum thickness of the joint parts to be welded.

2.7.4.11 When welding a joint, the weld's beginning of 20 to 30 mm in length and the weld end of 30 to 40 mm in length shall be executed on technological bars fitted prior to welding. If on the ends of the joint an allowance has been signed of at least 30 mm in size, the technological bars are not needed, the beginning and ending of the weld will be located on the allowance metal.

It is allowed to do without technological bars in joints completed by manual arc welding and semiautomatic gas shielded welding.

The dimensions of technological (extension) bars shall correspond to the thickness t of parts to be welded and to welding method:

.1 the thickness of bars shall be equal to the thickness of parts to be welded. For joints with thickness above 20 mm made by double-sided welding bars of lower thickness may be employed;

.2 for joints made by one-side automatic submerged- arc welding on copper sliders the starting technological bar shall have dimensions $200 \times 100 \times t$, mm, the end bar – $600 \times 400 \times t$, mm;

.3 for joints made by electrogas vertical welding with forced formation of the weld the dimensions of technological bars shall be $700 \times 450 \times t$, mm;

.4 for joints made by methods other than those mentioned above the dimensions of extension (starting and ending) bars are $100 \times 100 \times t$, mm.

The extension bars fitted in joints with edge preparation shall have the same type of edge preparation. The use of extension bars without edge preparation is also permitted, if the joint shall be welded from two sides.

2.7.4.12 When the welding is done without extension bars, it is not permitted to strike the arc or to have an arc crater on the surface of base metal outside the weld zone. At completion of the welding the arc shall be extinguished only after filling of the crater with metal.

2.7.4.13 In using of double-sided welds the welding shall be started from the side opposite to the side with tack welds. To start welding from the side with tack welds is allowed when in assembling of the joint it was difficult to tack-weld on the other side and if there is a special instruction to this effect in the WPS.

2.7.4.14 In multilayer welding the beginning and the end of each subsequent layer shall be displaced by 20 to 30 mm in relation to the preceding layer towards the side opposite to the direction of welding. When making curvilinear joint the welding shall not be started or ended in places of turn.

2.7.4.15 After completion of each layer and of the weld as a whole, it is necessary to dress the weld metal and heat affected zone for removal of slag and metal sparks. The dressing shall be done after cooling down of the slag crust.

If the arc gets extinguished in the process of welding, the weld crater and adjoining portion from 10 to 15 mm in length shall be cleaned from slag. The arc-striking shall be performed at a dressed length of the weld.

2.7.4.16 To receive the necessary dimensions of weld in manufacturing a structure with intersecting welded joints it is necessary, before starting automatic arc welding at the intersecting lengths, to remove the weld of the first joint with subsequent restoration of the edge preparation structural elements, if the joint has bevelled edges, or to remove root reinforcement, if the edges are without bevel.

2.7.4.17 The manual and semi-automatic welding shall be carried out symmetrically, moving from the middle of the structure to its sides at joint lengths >2 m and running on at lengths ≤ 2 m.

Tee joints without edge preparation may, as a rule, be welded in one runs, if the fillet weld leg does not exceed 8 mm.

2.7.4.18 Welding of parts manufactured from a shipbuilding steel by cold bending may be done without heat treatment, if the internal radius of the bend corresponds to the standards. In the absence of such standards the radius shall be not less than three plate thicknesses.

2.7.4.19 In the course of welding operations it is necessary to observe and confirm by permanent monitoring the conditions of storage, calculation, preproduction inspection (if required) and repeated issue of unconsumed welding materials as specified in the requirements of relevant technical documents and recommendations of the welding consumables manufacturer. Special attention shall be paid to materials susceptible to

absorption of moisture from the ambient air, to coated electrodes, welding fluxes, flux-cored wires employed for welding of higher and high strength steels.

2.7.4.20 The shielding gases and their mixtures used for welding shall have controllable cleanness and dew point complying with the requirements of national standards and/or requirements of the documents on welding procedure. Unless otherwise agreed with the Register, the provisions of [Table 2.7.4.20](#) shall be met.

Table 2.7.4.20

Requirements with respect to dew point and humidity of shielding gases and their mixtures used for welding

Group	Dew point at 1,013 bar, °C, not more than	Humidity, ppm, not more than
R	-50	40
I	-50	40
M1	-50	40
M2	-44	80
M3	-40	120
C	-40	200
F	-50	40
Oxygen	-50	200
Hydrogen	-50	40

2.7.4.21 The equipment used for welding operations shall be capable to ensure duties and parameters specified by the welding procedure. For setting and control of the welding duty parameters for correct readings, the welding equipment shall be provided with serviceable measuring instruments:

automatic welders – with an ampermeter, voltmeters, speed indicator or special scale for speed setting;

semi-automatic welders – with an ampermeter and voltmeter;

mechanized gas-shielded welding stations – with gas consumption control devices;

manual welding stations – with an ampermeter.

In manual arc welding the required value of current may be set by current meters at ballast resistors, with periodic checking by a portable ampermeter.

2.7.5 Underwater welding and welding of structures having their back side in contact with water.

Underwater welding and welding of structures having their back side in contact with water are performed in compliance with the requirements of 2.14, Part XIV "Welding" of the RS Rules/C.

2.8 PARTICULAR FEATURES OF HIGH-STRENGTH STEEL STRUCTURE WELDING

2.8.1 The requirements of this Chapter apply to manufacture of high-strength steel structures meeting the requirements of 3.13, Part XIII "Materials" of the RS Rules/C, and are also applicable to steels supplied in accordance with international and national standards and having a similar level of properties and similar requirements for chemical composition.

2.8.2 The welding consumables used in manufacture of high-strength steel structures shall meet the requirements of 4.7, Part XIV "Welding" of the RS Rules/C, and the applicable welding procedure shall be approved by the Register in compliance with the requirements of Section 6, Part III "Technical Supervision during Manufacture of Materials" of the Rules TSDCS.

2.8.3 In welding of high-strength steel structures the requirements of 2.7 shall be met taking into account special requirements listed below.

2.8.4 It is recommended to use welded joints of symmetrical form, both in dimensions of reinforcement and shape of edge preparation. The symmetrical form of welded joint is achieved by symmetrical edge preparation or by preliminary asymmetrical edge preparation with subsequent shaping of the joint to give it a symmetrical form.

The welded joints of asymmetrical form are used when it appears necessary due to special design features of the product.

2.8.5 In butt joints between parts of different thickness it is necessary to provide for single or double bevel at the edge of the larger thickness part with a slope not exceeding 1:5.

Note. It is permitted to do without bevel, if one edge is higher than the other by not more than:
 1,5 mm for parts with thickness below 20 mm;
 2,5 mm for parts with thickness > 20 up to 30 mm;
 3,5 mm for parts with thickness > 30 up to 40 mm;
 4,0 mm for parts with thickness > 40 up to 50 mm;
 for larger thicknesses: not more than $0,08t$.

It is recommended to remove the bevel mechanically. The weld dimensions in cases of bevel removal are measured at the part of smaller thickness. If there is no equipment available for bevel removal by mechanical methods, it is permissible to remove the bevel by thermal cutting with subsequent dressing by an abrasive tool.

When the border of reinforcement is located at a distance from the beginning of the bevel equal to 10 mm or less, it is necessary to stipulate the minimum overlap of the bevel by 2 mm with smooth transition to the base metal.

2.8.6 To improve the reliability and serviceability of welded structures, the welds shall be located at the largest possible distance from each other.

The recommended minimum distance between the weld borders for parts with thickness up to 40 mm is indicated in [Table 2.8.6](#).

For parts with thickness above 40 mm the minimum distance between the weld boundaries in all cases shall exceed 2,5 thickness of the parts.

Table 2.8.6

100 mm	60 mm
Between rectilinear welds	Between curvilinear welds with radius below 250 mm
Between curvilinear welds with radius of 250 mm and above	Between curvilinear welds with radius below 250 mm and rectilinear welds
Between curvilinear welds with radius of 250 mm and above and rectilinear welds	Between curvilinear welds with radius below 250 mm and curvilinear welds with radius of 250 mm and above

2.8.7 For special and primary structural elements with their high cyclic loading, the required service life can be obtained by application of special design and technological measures:

- .1 grinding of butt-welded joint on both sides flush with the base metal or machining to match the radius of the T-joint;
- .2 plastic surface treatment of transition zone between the weld and base metal;
- .3 argon-arc melting (TIG) of transition zone between the weld and the base metal.

The details of weldment implementation with application of the measures mentioned above shall be given in the drawings and are subject to approval by the Register at the stage of review of technical documents on manufacture of welded structures.

Implementation of the above measures shall be based on the results of the fatigue strength evaluation in accordance with the method approved by the Register.

2.8.8 In execution of fillet welds the preference shall be given to welding with a free edge extended by a value of at least two thicknesses of the part to be welded on, refer to [Fig. 2.8.8-1](#). If it proves to be impossible to execute fillet joints, as shown in [Fig. 2.8.8-1](#), one can compensate for it by overlapping the edge end faces with weld reinforcement. In such a case the distance between the weld-to-base metal transition zone and the free edge boundary shall not exceed $1/3t$ or 8 mm (whichever is less), as shown in [Fig. 2.8.8-2](#) (refer also to [2.6.2.3](#)).

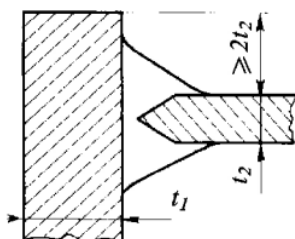

Fig. 2.8.8-1

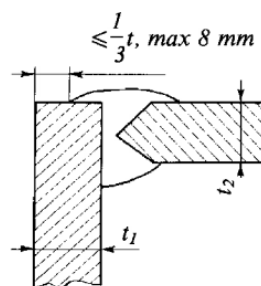

Fig. 2.8.8-2

2.8.9 When forming cruciform welded joints (splitted T-joint) the most preferable solution is extension of the main (non-splitted) part by a value of at least three thicknesses of the abutting workpiece (refer to [Fig. 2.8.9-1](#)). If it is not possible to produce a cruciform (non-splitted tee) joint, as shown in [Fig. 2.8.9-1](#), the edge of the main non-splitted part shall be arranged within the same plane with parts welded to it from both sides. In this case the reinforcement of weld shall overlap each of the gaps by at least 2 mm, as shown in [Fig. 2.8.9-2](#) (refer also to [2.6.2.3](#)).

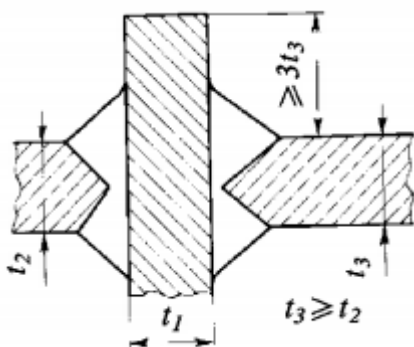

Fig. 2.8.9-1

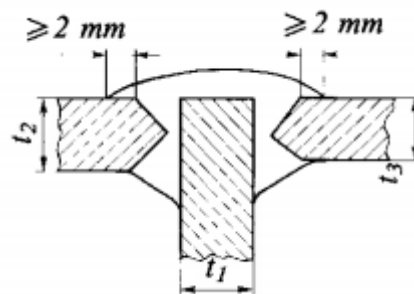

Fig. 2.8.9-2

2.8.10 Edge preparation for welding and removal of the bevel (when joining parts of different thickness) is better to be performed by mechanical method. If the preparation of edges was done by thermal cutting or if there are protective shop primer coatings remaining on the edges and adjoining surfaces of parts assembled for welding, the above surfaces shall be dressed with the use of abrasive tools, as shown in [Fig. 2.8.10](#).

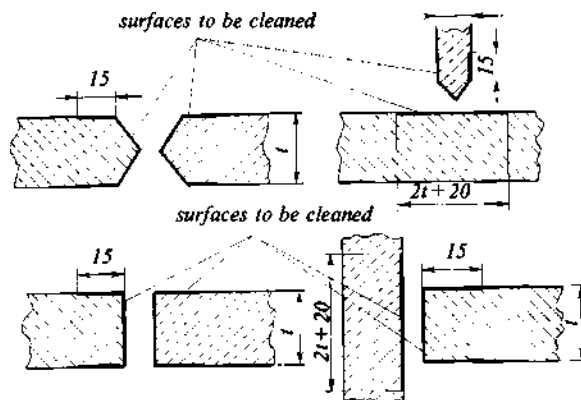

Fig. 2.8.10
Diagram of cleaning of edges in parts to be joined

Note. Welding of high strength steel parts without preliminary removal of shop primer from the edges to be welded may be permitted on the basis of tests (refer to [2.7.1.5](#)), including determination of diffusive hydrogen content in the metal deposit of welding materials, namely coated electrodes.

2.8.11 The butt faces of edges in primary and special structures not intended for welding shall be cleaned after thermal cutting with an emery disk, or machined, to give them the roughness of $R_z \leq 80 \mu\text{km}$.

In such cases any sharp corners on free edges are not permitted, they shall be rounded in compliance with the requirements of design documentation on manufacture of structures.

2.8.12 Eyes, lugs and temporary fastening attachments shall be welded on with the use of "annealing beads" applied by manual welding with coated electrodes, or by manual argon-arc with tungsten electrode, or by mechanized gas-shielded welding. Welding consumables employed for the purpose, as well as welding operation conditions shall meet the requirements for welding of steels of relevant grades (refer also to [2.7.1.13](#)).

2.8.13 The temporary fastening welds shall be removed by gas cutting or by arc-air gouging leaving "stubs" of 0,5 to 3,0 mm height over the surface of the base metal with

subsequent dressing of them with abrasive tools (to make them flush with metal surface) and testing for the absence of cracks. The non-destructive testing is carried out by visual testing with the use of a magnifying glass with at least X2 magnification. In questionable cases the testing shall include the use of penetrant or magnetic particle methods.

2.8.14 Elimination of individual defects on the base metal surface, which result from removal of temporary fasteners shall be carried meeting the requirements of 3.2.7, Part XIII "Materials" of the RS Rules/C.

It is permitted to eliminate by local dressing defects with depth up to 1,0 mm at metal thickness of up to 20 mm inclusive and up to 1,5 mm at metal thickness above 20 mm.

For repair of defects with depth above 3 mm by welding with subsequent dressing a request shall be submitted to the Register for approval of repair technology, including the WPS.

The defects may be rewelded only after dressing by an abrasive tool with subsequent testing of the dressed spots for absence of cracks. The rewelding shall be done with the use of welding consumables approved by the Register for steels of appropriate grades, meeting all the requirements for welding operation. The rewelded spots, after dressing down to the rated thickness, shall be tested for the absence of cracks using penetrant testing.

2.8.15 The most preferable for welding of high-strength steel structures is multirun welding with weld root dressing for joints with full penetration. Use of one- or two-run technique, electroslag or gas-arc welding, for well as multiarc and single-sided welding is permitted on the basis of tests conducted according to the program approved by the Register (refer also to [2.5.5](#)).

2.8.16 In operation involving welding of high-strength steel structures the relevant requirements of [2.7.2](#) and [2.7.3](#) shall be fully met, taking into account the following:

.1 the minimum preheat temperature and temperature between runs shall be in compliance with the requirements of [Table 2.8.16](#);

.2 when welding is carried out at open-air sites, the welding zone and adjoining surfaces at a width of at least 100 mm to both sides from the joint edges shall be dried with gas burner flame until all moisture is fully removed. If in the course of multirun welding some breaks occur in the work, the drying of the welding zone shall be repeated before application of the next bead;

.3 the preheating shall be carried out with the use of resistance heaters, gas or electric infra-red heaters, induction heaters. In certain cases it is permitted to use heating with open flame of gas burners;

.4 the temperature between runs may be maintained at the required level by heat input coming directly from the welding, i.e. autopreheat, or by heat from external sources;

.5 the preheat temperature before welding and temperatures in the process of welding are subject to mandatory monitoring by the manufacturer's technical control services with recording results in accordance with the established procedure;

.6 in cases of welding with coated electrodes in conditions of absolute air humidity equal to 12 g/m³ or more the welding zone preheat to at least 50 °C is required, unless it was specified earlier, or increase in minimum preheat temperatures and temperatures between runs by 20 °C (refer to [Table 2.8.16](#));

.7 in cases of unforeseen interruptions in multirun welding with preheat decelerated cooling of the welded joint shall be ensured, and before resumption of the welding the joint edges shall be preheated to the required temperature;

.8 when welding steels of various grades and thicknesses the required preheat temperature and temperatures between runs shall be specified taking for reference the steel for which such temperatures are the highest.

Table 2.8.16

Requirements for preheating temperature in welding of high-strength steels

Grade of steel to be welded	Metal thickness, mm	Ambient air temperature, °C	Content of diffusible hydrogen in deposited metal, cm ³ /100 g	Minimum temperature of preheat, °C	Minimum temperature between runs, °C
(A/F) 690	up to 130	0 and above	up to 3,0 (H3)	80	80
			above 3,0 to 5,0 (H5)	100	80
		below 0 to -10	up to 3,0 (H3)	120	100
			above 3,0 to 5,0 (H5)	130	120
		below -11 to -15	up to 3,0 (H3)		
(A/F) 620 and (A/F) 550	up to 40	0 and above	up to 3,0 (H3)	40	50
			above 3,0 to 5,0 (H5)	60	60
		below 0 to -15	up to 3,0 (H3)	80	80
			above 3,0 to 5,0 (H5)	100	80
	below -16 to -20	up to 3,0 (H3)			
	41 — 100	0 and above	up to 3,0 (H3)	60	60
			above 3,0 to 5,0 (H5)	100	80
		below 0 to -15	up to 3,0 (H3)	120	80
			above 3,0 to 5,0 (H5)	120	100
		below -16 to -20	up to 3,0 (H3)		
(A/F) 500		up to 40 inclusive	0 and above	up to 3,0 (H3)	no preheat
	above 3,0 to 5,0 (H5)			40	50
	above 5,0 to 10,0 (H10)			60	60
	below 0 to -15		up to 3,0 (H3)	60	80
		above 3,0 to 5,0 (H5)	80	80	
	below -15 to -20	up to 3,0 (H3)	100	80	
	above 40 to 100 inclusive	0 and above	up to 3,0 (H3)	60	60
			above 3,0 to 5,0 (H5)	80	80
		below 0 to -15	up to 3,0 (H3)	80	80
			above 3,0 to 5,0 (H5)	100	80
below -15 to -20	up to 3,0 (H3)				
(A/F) 460 and (A/F) 420	up to 40 inclusive	0 and above	up to 3,0 (H3)	no preheat	40
			above 3,0 to 5,0 (H5)	40	50
			above 5,0 to 10,0 (H10)	60	60
		below 0 to -15	up to 3,0 (H3)	50	50
			above 3,0 to 5,0 (H5)	50	50
			above 5,0 to 10,0 (H10)	80	60
	below -15 to -20	up to 3,0 (H3)	100	80	
		above 3,0 to 5,0 (H5)			
		0 and above	up to 3,0 (H3)	40	50
			above 3,0 to 5,0 (H5)	60	60
			above 5,0 to 10,0 (H10)	60	60
		above 40 to 100 inclusive	below 0 to -15	up to 3,0 (H3)	60
above 3,0 to 5,0 (H5)	60			60	
above 5,0 to 10,0 (H10)	80			60	
below -15 to -20	up to 3,0 (H3)		100	80	
	above 3,0 to 5,0 (H5)				
	above 5,0 to 10,0 (H10)				

Notes: 1. The table specifies the minimum level of requirements concerning the preheating temperature and temperature between runs for hardened and tempered steels on the basis of tendency to cold cracking. When such requirements are satisfied, the Register accepts the Welding Procedure Specification for review.

2. For steels of grades (A/F) 500, (A/F) 460 and (A/F) 420 manufactured with the use of thermomechanical treatment and accelerated cooling and having $C_{equip} \leq 0,41\%$, lower preheat and temperatures between runs are acceptable.

3. Actual values of preheat temperature and temperature between runs shall be approved by the Register on the basis of tests for approval of welding procedure, including control of all limiting parameters of a particular project (maximum hardness of the heat affected zone, values of CTOD for the heat affected zone and the weld, etc.).

2.8.17 Efficient autopreheating of edges to be joined by manual (with coated electrodes and argon-arc with tungsten electrodes) welding and semiautomatic gas-shielded welding may

be achieved by using the block method. The method consists in subdividing of a technologically self-dependent welded joint into several areas (blocks) equal in length welded simultaneously by several welders, the block length depends on the thickness of parts to be welded; the following values are recommended:

- up to 2000 mm in welding of steels up to 40 mm inclusive in thickness;
- up to 1500 mm in welding of steels from 40 to 70 mm inclusive in thickness;
- up to 1200 mm in welding of steels above 70 mm in thickness.

Welding of all the blocks shall be carried out simultaneously over the whole length of technological area without breaks until the joint gap or full cross-section of the weld is filled. All beads within a block shall be applied throughout the length. In doublesided joints the welding, if possible, shall be done from both sides simultaneously.

The beginning and end of each layer in a block shall be displaced by 20 to 30 mm in relation to the preceding layer. It is not permissible to butt the blocks at the intersections of welds.

2.8.18 When root beads are made by manual arc welding (with coated electrodes and by argon-arc welding with tungsten electrodes), as well as by semiautomatic gas-shielded welding, additional measures shall be taken to avoid cracking.

One of the recommended measures is application of the "bead bond" method (refer to [Fig. 2.8.18](#)), as well as increase in the bead height up to 6 — 8 mm in the cross-section height on each side of the joint.

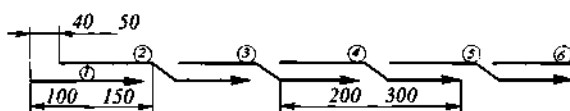

Fig. 2.8.18

Diagram of welding of root runs in application of "bead bond" method

2.8.19 In welding of special structures, as well as primary structures in contact with sea water the last run of the weld shall be applied using the method of "annealing bead", refer to [Fig. 2.8.19](#). The annealing bead is applied in such a way as to overlap about two thirds of the width of the bead (run) extreme in relation to the base metal surface.

When using temporary assembly attachments (refer to [2.8.12](#)) fastened by fillet welds without edge preparation, the annealing bead can be applied as additional, with relevant asymmetrical increase in dimensions of fillet weld (refer to [Fig. 2.8.19](#)).

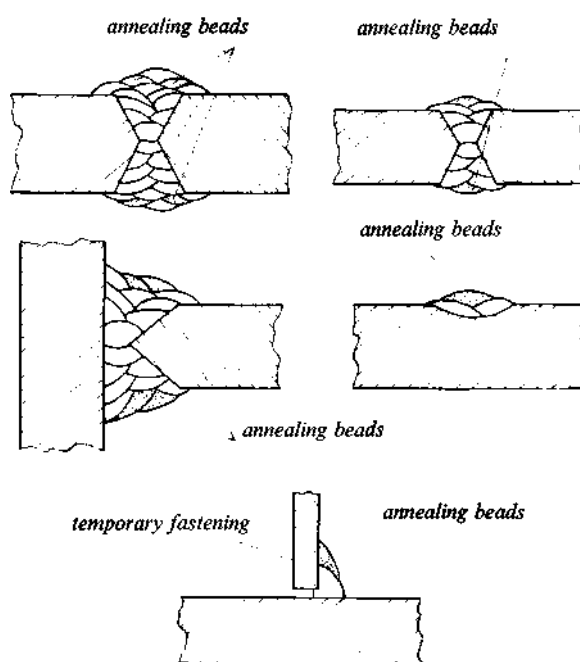

Fig. 2.8.19
Diagram showing the sequence of layers in application of "annealing beads"

2.8.20 At thermal treatment (tempering for relieving of residual stresses) of welded structures made of high-strength steels it is necessary to take into account a possibility of emergence of additional unfavourable factors:

- .1 formation of tempering cracks (of the first and second type) in the welded joint;
- .2 tendency to embrittlement at tempering of the heat affected zone in certain grades of steel micro-alloyed with niobium and vanadium, especially when they are welded with high heat input (above 35 to 40 kJ/cm).

Note. The tendency of steels to cracking can be detected by simultaneous appearance of positive values of parameters ΔG and P_{SR} calculated by the formulae:

$$\Delta G = Cr + 3,3Mo + 8,1V + 10C - 2;$$

$$P_{SR} = Cr + Cu + 2Mo + 10V + 7Nb - 5Ti - 2,$$

where Cr, Cu, Mo, V, Nb, Ti, C means percentage content of the relevant elements in steels.

This is why the non-destructive testing of welded structures shall be carried out after their heat treatment, including here use of test methods ensuring high detectability of in-plane defects.

2.8.21 The possibility of application and technology of thermal straightening of structures made of high-strength steels shall be specified on the basis of the steel manufacturer recommendations.

Thermal straightening may be used on the basis of satisfactory results of the tests conducted according to a separate program. The test procedure shall take into account integrated action of all unfavourable factors taking place in manufacture of structures in production environment. The test results are considered positive, if the properties of the base metal and weld after thermal straightening are in compliance with the relevant requirements of the Rules for the base metal and weld in the initial state.

Under such conditions the simulation of actual thermal and deformational action on metal in thermal straightening of actual structures may be permitted with the use of large-size simulation samples.

2.9 WELDING OF CLAD STEELS

2.9.1 The requirements of this Chapter apply to welding of clad steels manufactured by various methods and of these steels joining to stainless and low-alloyed steels.

2.9.2 The welding consumables employed in manufacture of parts and structures made of clad steels shall be approved by the Register and, depending on their function, meet the requirements listed below:

.1 the basic layer shall be welded, as a rule, with the use of low-alloyed consumables approved for welding of steels compatible in composition, or grade, and properties with the basic layer;

.2 the cladding layer shall be welded with the use of consumables approved for welding of stainless steel corresponding in composition and properties to cladding layer metal. In this case one of the main requirements shall ensure corrosion resistance of the weld metal in compliance with the requirements for cladding layer taking into account the future service conditions (temperature and corrosive action of the environment);

.3 the interlayer (transitional from low-alloyed weld metal to high-alloyed cladding metal) shall be welded with the use of high-alloyed consumables approved for this purpose or for welding of heterogeneous materials. In this case the main requirement is absence in the interlayer of crack-type defects due to generation of brittle components at considerable dilution (up to 40 %) of the deposited metal coming from the lower runs (of the basic layer);

.4 if the process procedure requires welding of the basic layer with high-alloyed materials, the latter shall have approval for:

welding of heterogeneous joints (of low-alloyed to high-alloyed), if there is no buttering of edges with welding consumables intended for the interlayer;

welding of stainless steels of the appropriate type (compatible with the cladding layer), with preliminary buttering of edges at the basic layer. It shall be understood that the whole weld is produced employing the consumables corresponding to the cladding layer.

Note. For the interlayer and heterogeneous joints high-alloyed filler materials of type X2CrNi2412 (AISI:309L), X10CrNi2412 (AISI:309S), X10CrNiCb2412 (AISI:309SCb) shall be generally used.

2.9.3 The welders working with clad steels shall first complete the required training and be approved by the Register on the basis of practical tests conducted in accordance with a special program.

Note. The welders having Test Approval Certificates with the scope of approval covering several individual groups of low-alloyed and stainless steels may be approved by the Register for welding of clad steels in the way of exception (provided their practical experience in welding of clad steels may be confirmed).

2.9.4 Approval of welding procedure for clad steels is carried out by the Register using individual programs, and the scope of testing is specified individually in each particular case, taking into account:

.1 type of joint and particulars of edge preparation (indicating here also, whether some cladding material shall be taken away or not);

.2 applicable welding procedure and sequence of welding of basic and cladding layers;

.3 availability at the manufacturer of welded structures of the Register approval for welding procedure in which similar welding consumables and base metals are indicated separately for the basic and cladding layer;

.4 requirements for corrosion resistance of the cladding layer weld metal subdivided by the types of corrosion damage (intercrystalline corrosion, pit corrosion, hydrogen sulphid cracking).

2.9.5 When selecting the structural elements of edge preparation for welding the following particular features of clad steel welding procedure shall be taken into account:

.1 as a rule, first the weld on the basic layer side shall be made and only after that the weld on the cladding layer side;

.2 when the weld on the basic layer side is made with the use of low-alloyed consumables, the possibility of partial melting of the cladding layer shall be excluded;

.3 before welding of the cladding layer the weld root shall be dressed by machining;

.4 before welding of the cladding layer, as a rule, an intermediate transition layer shall be introduced with the use of high-alloyed filler consumables of a special type;

.5 the weld on the cladding layer side shall consist of at least two layers. In some cases, involving procedure with insignificant base metal presence in the weld metal (as in the case of plasma overlaying) and at the appropriate level of filler consumable alloying it is permissible to make the cladding weld in one layer having the thickness not lower than that of the base metal cladding layer;

.6 when welding the joint on the cladding and basic layer side, a possibility shall be provided, if possible, for deposition of annealing beads. For this purpose, in butt joints a partial removal of cladding metal adjoining to the edges to be welded may be effected (on a width of 4 to 8 mm to both sides), or the groove angle may be increased;

.7 when welding double-bevel butt joints and producing the basic layer on the cladding side with the use of low-alloyed consumables, measures shall be taken to exclude the possibility of partial melting or damage to the base metal cladding layer. For this purpose, it is permissible to remove the base metal cladding layer on a width of 4 to 8 mm to both sides of the groove;

.8 in tee and cruciform joints with full penetration and with high level tensile stresses (especially at dynamic loads) it is recommended to employ welding with partial removal of the cladding layer on the main (non-split) part.

The examples of welded joints made in accordance with the above requirements and recommendations are given in [Figs. 2.9.5-1](#), [2.9.5-2](#) and [2.9.5-3](#).

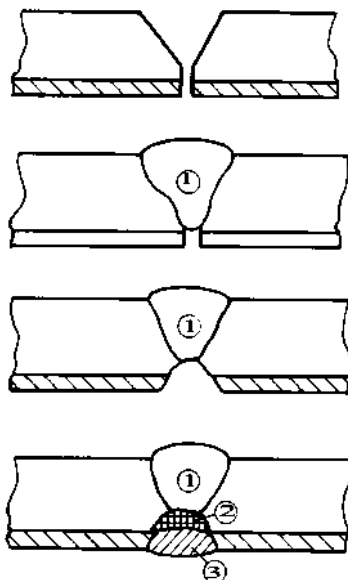

Fig. 2.9.5-1

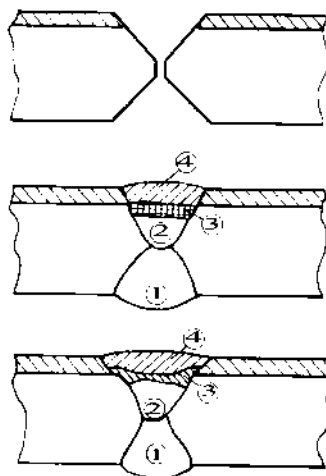

Fig. 2.9.5-2

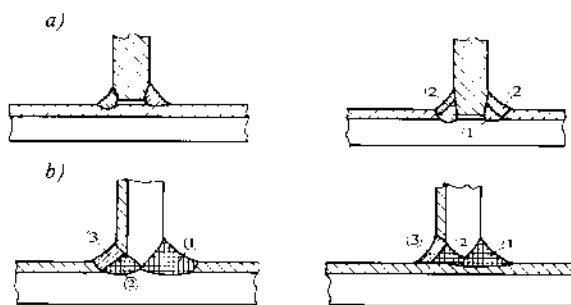

Fig. 2.9.5-3

2.9.6 In manufacture of structures and components from clad steels care shall be taken to protect the cladding layer surface against damage and contamination with foreign metal inclusions.

Tack welds and temporary setting-up fixtures employed in assembly of clad steel structures for welding shall be located on the side of basic layer. It is not allowed to fit the temporary setting-up and levelling (by welding) fixtures on the side of cladding layer.

2.9.7 Preparation of edges for welding shall be performed by mechanical methods.

In case of application of thermal cutting (such as plasma or laser cutting) it is necessary to subject the edges to additional dressing. The depth of mechanical dressing on the cladding layer side shall be 1,0 to 1,5 mm. When welding together parts with different thickness the excessive bevel shall be removed by mechanical methods on the basic layer side.

2.9.8 The procedures and conditions of clad steel welding shall meet the requirements of relevant regulating documents and instructions of welding consumables manufacturers. Besides, the following requirements and recommendations shall be taken into account:

- .1 cutting-out of the weld root on the cladding layer side can only be done by milling or grinding;
- .2 for welding of the cladding layer, as far as possible, the electrodes and welding wire of small diameter shall be used and the welding shall be carried out with low energy input;
- .3 when the cladding weld is executed in two layers, it is permitted to carry out preliminary levelling of the preceding layer metal surface by mechanical methods or grinding (this applies to the intermediate layer and the first cladding layer).

2.9.9 The welding procedure for clad pipes with one-side access (from the basic layer side) allows the use of the following patterns ensuring the acceptable level of the welded joint quality:

.1 a cladding layer is produced by single-sided unsupported welding with back formation of the weld root (as a rule, the best results are obtained using inert gas shielded welding with non-consumable electrode and additional gas back-up). It is recommended to select filler consumable with a higher degree of alloying with reference to the cladding layer (and, respectively, with a higher corrosion resistance), because partial melting of the basic layer metal is inevitable anyway. Filling of the groove within the basic layer is performed using high-alloyed filler consumable suitable for welding of heterogeneous joints (such as AISI: 309, 309L, 309SCb);

.2 a cladding layer is produced by one-side unsupported welding, as specified in [2.9.9.1](#) above. Filling of the groove within the basic layer is performed using consumables intended for stainless steels, over preliminarily battered edges. For battering of the edges consumables intended for deposition of the intermediate layer are used;

.3 a cladding layer is produced by single-sided unsupported welding, as specified in [2.9.9.1](#). Over the root run a two-layer deposition is made with the use of filler consumables based on commercially-pure iron, ensuring the minimum intermixing of metals in the layers. Filling of the groove within the basic layer is done with the use of low-alloyed consumables fully corresponding to the grade or brand of steel in the basic layer of the clad steel;

.4 the whole joint cross-section, including the root portion and groove, is welded with the use of high-alloyed filler consumables on nickel base (such as alloys of type Inconel 625: 62Ni-22Cr-9Mo and others). In this case there is no need for edge buttering in the basic layer.

The particular version of clad pipe welding shall be selected taking into account the strength features of the basic layer and the wall thickness. For instance, for thick-wall clad pipes made of high-strength steel the most suitable version may be the one specified in [2.9.9.3](#).

2.9.10 The welding procedure for butt joints between clad steel and stainless steel permits the use of the following groove filling arrangements (refer to [Fig. 2.9.10](#)):

.1 the welding is done over the whole joint cross-section with the use of filler consumables intended for cladding layer welding. In this case it is required to carry out preliminary buttering of edges to be welded on the side of the clad steel basic layer with the use of filler consumables intended for deposition of intermediate layers (refer to [Fig. 2.9.10 \(a\)](#));

.2 from the side of the basic layer the welding is done with high-alloyed consumables intended for heterogeneous joints after mechanical dressing of the weld root; from the cladding side a two-layer cladding deposit is applied with the use of stainless filler consumables (suitable for joints with single bevel) (refer to [Fig. 2.9.10 \(b\)](#)).

Note. In joints with double bevel the groove is first filled flush with the cladding lower edge with materials intended for welding of heterogeneous joints, after that a two-layer cladding deposit is applied using stainless filler consumables.

Examples of fillet welds in T-joints in structures made of stainless and clad steels are shown in [Fig. 2.9.5-3](#).

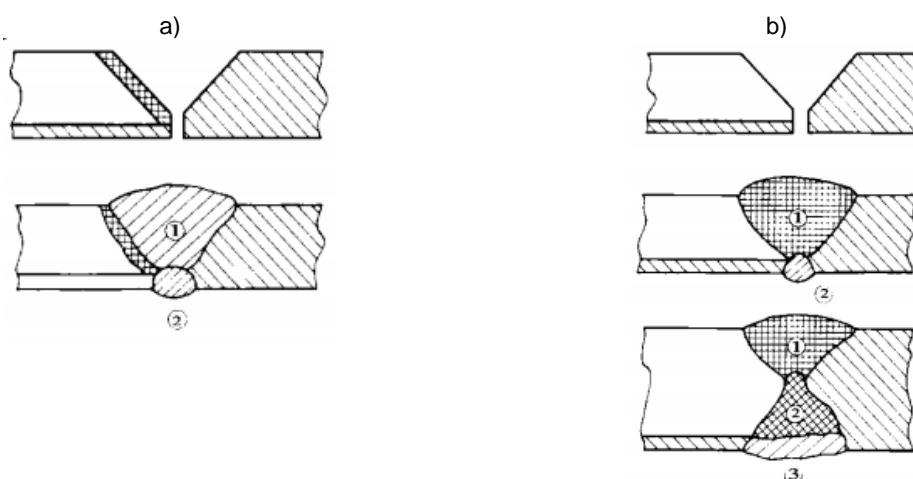

Fig. 2.9.10

1, 2, 3 – sequence of weld building-up

2.9.11 In welding of butt joints between clad and low-alloyed steels the following sequence of operations shall be provided (refer to [Fig. 2.9.11](#)):

.1 welding from the side of basic layer with the use of low-alloyed consumables meeting the requirements of 2.5 for relevant steel categories;

.2 mechanical grooving of the weld root from the side of cladding and capping of it in joints with single bevel using filler consumables intended for heterogeneous joints. In joints with double bevel first welding of the base layer of clad plate is performed, after which a single or twin layer deposition is made with the use of consumables intended for welding of heterogeneous joints.

Note. In double-sided joints of large thickness it is permissible to make the facing beads on the cladding side not over the whole width of the groove (refer to [Fig. 2.9.11](#)).

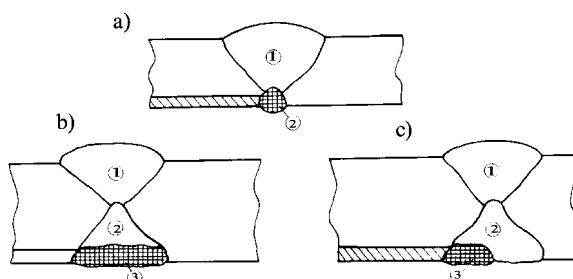

Fig. 2.9.11

1, 2, 3 – sequence of weld building-up

2.9.12 The possibility of heat treatment and conditions of this process for clad steel parts and structures shall be established in accordance with the manufacturer's instructions for steels and welding consumables. During approval of welding procedures by the Register all the necessary tests shall be conducted after heat treatment similar to that conducted in the course of manufacture.

2.10 WELDING OF STRUCTURES OF MACHINERY AND MACHINERY INSTALLATIONS

2.10.1 These requirements cover welding of structures and products of engineering industry manufactured with the use of base materials and welding consumables meeting the requirements of Part XIII "Materials" of the RS Rules/C, Part XII "Materials" of the MODU Rules, as well as requirements of this Part. Manufacture of structures from materials not covered by the Rules shall be carried out in compliance with the documentation approved by the Register.

2.10.2 The consumables for welding of structures of machinery and machinery installations are selected for particular brands of steel applicable in manufacture taking into account the requirements of [2.5.4 to 2.5.6](#).

If the structures are utilized at high temperatures or in a chemically-active environment, the welding consumables shall be selected making allowance for these factors.

2.10.3 For welding of parts of machinery and machinery installations made of steel with thickness of 30 mm and above such welding consumables shall be used which ensure the welded joint resistance to cold cracking, otherwise the manufacturer shall take technological measures (preheating, thermal treatment, limitation of ambient air temperature in welding, etc.) to prevent formation of cold cracks.

2.10.4 Welds in structures operating under dynamic loads shall be made with full penetration. Transition from the base metal to the weld metal shall be smooth.

2.10.5 Use of welding in manufacture of shaft- lines and crankshafts is permitted when the following requirements are met.

The mandatory conditions in such cases are non-destructive testing of all welds and guaranteed fatigue strength limit of welded joints fixed in the design.

The scope of required pilot welding and the test program shall be agreed with the Register before the starting of work.

2.10.6 Use of welding, building-up, metal pulverization and similar methods in manufacture and repair of engineering products may be permitted if positive results are obtained in tests conducted in accordance with the procedure agreed with the Register and confirming the possibility of application of the given method at a particular firm.

Shafts made of carbon steels (containing up to 0,45 % of carbon), either worn or having surface cracks, can be repaired by building-up, if the wear or depth of cracks does not exceed 5 % of shaft diameter, but it shall not be over 15 mm.

2.11 WELDING OF STEAM BOILERS AND PRESSURE VESSELS

2.11.1 Welds in boilers shall have marks showing which welder has done the job.

The longitudinal and circumferential welds in boiler shells shall be produced with back-sealing run, except for cases when the efficiency factor of welded joints, in compliance with 2.1.6, Part X "Boilers, Heat Exchangers and Pressure Vessels" of the RS Rules/C, is assumed $\leq 0,7$.

The cutouts and openings in the boiler shell are not, as far as possible, to cross the circumferential and longitudinal welds in the boiler shell.

Possibility of welding of any fastenings, catches and similar parts for erecting purposes to the boiler shell shall be specified in the documentation submitted to the Register for agreement.

The longitudinal and transverse welds on headers, boiler shells and pressure vessels shall be in the form of butt joints.

2.11.2 Welding consumables for welding of boilers and pressure vessels shall be selected depending on particular grades of steel used for manufacture of the above products in compliance with the requirements of [2.5.4 to 2.5.6](#).

2.11.3 Use of electrodes with rutile and oxide coatings for welding of boilers and pressure vessels of Class I (refer to 1.3.1.2, Part X "Boilers, Heat Exchangers and Pressure Vessels" of the RS Rules/C) is not permitted; they may be used for boilers and pressure vessels of Classes II and III, if these structures are made of carbon steels and if the thickness of parts to be welded does not exceed 20 mm.

2.11.4 The heat treatment of boilers and pressure vessels is carried out in accordance with the standards or taking into account the recommendations of steel manufacturers.

The welded joints between parts which, due to their size or particular design, cannot be subjected to stress relief heat treatment as a whole, may be treated in parts. In this case the treatment shall be effected by uniform heating of a wide enough area along the weld (about six thicknesses of the plate on both sides of the weld) excluding propagation of thermal stresses to adjacent portions of the parts. Local treatment by welding torch is not allowed.

2.11.5 Sealing of openings in boilers by welded-in plugs shall be performed meeting the requirements of national standards.

2.11.6 Repair of worn-out shell plates of boilers and pressure vessels by building-up shall be agreed with the Register. The built-up area shall not exceed 500 cm², the depth shall not be more than 30 % of the plate thickness. If such conditions cannot be satisfied, the defective area shall be replaced with a new plate.

2.11.7 When manufacturing boilers, heat exchangers and pressure vessels of Classes I and II (refer to 1.3.1.2, Part X "Boilers, Heat Exchangers and Pressure Vessels" of the RS Rules/C), test samples shall be prepared to check-up the mechanical properties of the welded joints in the case of unique products being manufactured, serial production on the prototype product, alterations in the structure of main parts, application of new materials and welding procedures.

The test samples for products belonging to Class III may be prepared if required by the Register.

2.11.8 The test samples shall be fixed to a longitudinal weld of the boiler or pressure vessel in such a way that the weld on the test plate is a continuation of the weld on the product. The test plates shall be welded by the same method (under the same technological conditions) as the weld on the product.

The test sample thus prepared is used to manufacture and test one transverse specimen for tension, two transverse specimens for bending, three specimens for impact: they are cut out as shown in Fig. 4.3.3.1, Part XIV "Welding" of the RS Rules/C.

Specimens for structures of Class III shall be manufactured as required by the RS surveyor. The conditions of cutting-out of specimens from test samples and testing shall meet the requirements of 4.2, Part XIV "Welding" of the RS Rules/C.

2.12 WELDING OF PIPELINES

2.12.1 The type of welded joints in pipelines shall be in compliance with the standards.

2.12.2 Selection of welding consumables for welding of pipelines is made depending on particular grades of steel applied in pipe manufacture taking into account the requirements of [2.5.4 — 2.5.6](#).

2.12.3 The welded butt joints in pipelines shall be performed with full penetration in the weld root. Use of removable backing rings in welding is permitted.

2.12.4 Use of remaining backing rings in butt joints of pipes is permitted in those pipelines where such rings do not affect negatively the pipeline performance. The butt welded joints between flanges and pipes shall not be made on the remaining backing rings.

2.12.5 Welded joints in pipes shall be subjected to heat treatment, if the pipes are made of low-alloyed steel and in case of gas welding of main steam pipelines operating at temperatures above 350 °C.

2.12.6 When welding pipes made of chrome- molybdenum steel containing 0,8 % of chromium or more, and more than 0,16 % of carbon, the edges to be welded shall be preheated to 200 to 230 °C. This temperature shall be maintained during the process of welding.

2.12.7 The edges to be welded in copper pipes with wall thickness of 5 mm and above shall be preheated to 250 — 350 °C. Welding of copper-nickel pipes shall be done without preheating. Use of soldering for joints in copper-nickel pipelines is not allowed.

2.12.8 The possibility of pipeline repairs by rewelding of damaged areas is permitted according to the procedure approved by the Register.

2.13 WELDING OF CASTINGS AND FORGINGS

2.13.1 In cases listed below welding of steel castings and forgings shall be carried out irrespective of the ambient air temperature with the use of preheating, or shall be taken other measures meeting the requirements for welded joints:

- .1 when carbon content in steel of castings or forgings exceeds 0,25 %;
- .2 when carbon content in steel of castings or forgings exceeds 0,23 %, if the castings and forgings are incorporated in hull structures of MODU.

2.13.2 The preheating temperature and heat treatment conditions for castings and forgings are determined depending on the design, dimensions and service conditions in compliance with the requirements of [2.7.2.4](#), [2.7.3.1](#) and [2.7.3.6](#).

2.13.3 Defects in steel castings and forgings may be repaired by rewelding only in cases when the weldability of the given steel has been duly checked and service conditions for cast or forged parts taken into account.

Repair of defects by rewelding shall be performed, as a rule, prior to completion of the heat treatment. Rewelding after heat treatment is allowed only in exceptional cases. The defects appearing regularly in castings and forgings shall not be repaired by rewelding.

2.13.4 Rewelding of defects in castings shall be carried out after removal of sprues and heads and thorough cleaning of castings from moulding materials, mill scale, foreign inclusions. The places to be rewelded shall be dressed to sound metal to ensure proper penetration throughout the welded area.

The walls in places prepared for rewelding shall be gently sloping, the surface of prepared depression shall not have any sharp comers.

2.14 WELDING OF CAST IRON

2.14.1 Repair of cast iron castings by welding is allowed using a method approved by the Register on the basis of the results of testing performed in accordance with a program agreed with the Register.

2.15 WELDING OF ALUMINIUM AND ITS ALLOYS

2.15.1 Welding operations shall be carried out by the most efficient method ensuring high-quality joint, with maximum strength, chemical composition close to that of the base metal, and sufficient corrosion resistance.

2.15.2 The welds shall be located, as far as possible, in areas of the lowest stresses. As a rule, welding shall be carried out in the downhand position.

2.15.3 Immediately before welding (tack welding) edges to be welded of parts made of aluminium and its alloys shall be degreased using special solvents (acetone, alcohol, etc.) and cleaned with steel wire brushes. Tacked spots before welding shall be also cleaned with wire brushes. In multirun welding each completed layer shall be cleaned with a wire brush before application of the next layer.

2.15.4 Welding consumables made of aluminium and its alloys shall be cleaned before welding to remove contaminations and oxide films.

2.15.5 Welding of aluminium alloys on permanent or removable backings is permissible. The backings removed after welding shall be made of stainless steel. The permanent backings shall be made of the same kind of alloy, of which the welded parts are made.

2.15.6 In case of double-sided welding, before back run it is necessary to cut out the weld root down to clean metal by chipping, gouging or milling. Cutting out of the root by abrasive disks is not allowed.

2.15.7 Hot straightening of structures made of aluminium and its alloys is permitted. The heating temperature at straightening shall comply with the properties of the particular alloy.

2.15.8 When a flux is used for welding, it shall be neutral, if possible. If a non-neutral flux is used, as an exception, it shall be thoroughly removed after welding.

2.15.9 In areas where aluminium alloys have riveted joints all the main welding operations shall be completed before the riveting is started.

**2.16 WELDING OF COPPER AND ITS ALLOYS, HEAVY METALS AND OTHER
NON-FERROUS METALS**

2.16.1 Welding of copper and its alloys, heavy metals and other non-ferrous metals is carried out in compliance with the requirements of the standards and/or documentation approved by the Register.

3 TESTING OF WELDED JOINTS

3.1 GENERAL

3.1.1 When performing testing of welded joints it is necessary to be guided by the provisions given in 3.1, Part XIV "Welding" of the RS Rules/C.

**3.2 REQUIREMENTS FOR PERFORMANCE AND MAIN PARAMETERS
OF NON-DESTRUCTIVE TESTING OF WELDED JOINTS**

3.2.1 The requirements for performance and main parameters of non-destructive testing of welded joints are given in 3.2, Part XIV "Welding" of the RS Rules/C.

3.3 EXTENT OF NON-DESTRUCTIVE TESTING

3.3.1 The welded joints of MODU structures of all categories shall be subjected to testing by visual testing over the whole length taking into account the requirements of 3.2.1.2, Part XIV "Welding" of the RS Rules/C. The extent of application of physical methods of non-destructive testing shall comply with requirements of [Table 3.3.1](#).

Table 3.3.1

Minimum extent of non-destructive testing for welded joints in MODU in % of total welds length

Categories of structures ¹	Type of joints	Welded joints in the topside (atmospheric) area				Welded joints in the boot-top (water-wetted) and underwater areas			
		Testing method							
		Visual	Magnetic particle ²	Radio-graphic ³	Ultra-sonic ⁴	Visual	Magnetic particle ²	Radio-graphic ³	Ultra-sonic ⁴
Special	Butt joints	100 %	20 %	100 %	–	100 %	100 %	100 %	–
	Corner, cross and T-joints, full penetration	100 %	100 %	–	100 %	100 %	100 %	–	100 %
	Corner, cross and T-joints, lack of fusion (with edge preparation)	100 %	100 %	–	–	100 %	100 %	–	–
	Fillet welded joints (without edge preparation)	100 %	100 %	–	–	100 %	100 %	–	–
Primary	Butt joints	100 %	10 % ⁵	10–20% ⁶	–	100 %	20%	20 %	–
	Corner, cross and T-joints, full penetration	100 %	20 %	–	10–20 % ⁶	100 %	20 % ⁵	–	20 % ⁶
	Corner, cross and T-joints, lack of fusion (with edge preparation)	100 %	20 %	–	–	100 %	20%	–	–
	Fillet welded joints (without edge preparation)	100 %	20 %	–	–	100 %	20%	–	–
Secondary	Butt joints	100 %	Spot ⁷	Spot ⁷	–	100 %	Spot ⁷	Spot ⁷	–
	Corner, cross and T-joints, full penetration	100 %	Spot ⁷	–	Spot ⁷	100 %	Spot ⁷	–	Spot ⁷
	Corner, cross and T-joints, lack of fusion (with edge preparation)	100 %	Spot ⁷	–	–	100 %	Spot ⁷	–	–
	Fillet welded joints (without edge preparation)	100 %	Spot ⁷	–	–	100 %	Spot ⁷	–	–

¹ Requirements for non-destructive testing of welded joints connecting structures of various categories shall be specified as for higher category.

² For nonmagnetic materials penetrant testing shall be used.

³ Upon agreement the radiographic testing may be partly or wholly replaced by ultrasonic testing based on technical feasibility of method application.

⁴ Ultrasonic testing shall be carried out for base metal thicknesses of 10 mm and above.

⁵ For welded joints of hull shell plating not subjected to high tensile strength, the extent of testing may be reduced up to 5 %.

⁶ The following assigned extent of testing is used:

– 10 % for joints subjected to static loads;

– 20 % for joints subjected to changing loads.

⁷ "Spot" means the extent of testing from 2 to 5 % as specified by the RS surveyor or designer.

3.3.2 As a rule, subjected to non-destructive testing shall be intersections of butt welded joints, cruciform joints and other joints located in zones with high level of stresses, also spots of beginning and ending of automatic welding and zones where the visual testing caused some doubts.

3.3.3 When testing intersections of butt welded joints by radiographic methods in compliance with the requirements of [3.3.2](#), the film shall be held symmetrically to the axis of the welded joint to be tested, so that it could partly cover the second joint (within the film width).

At random ultrasonic testing of butt welded joints intersections one shall cover lengths of 100 mm width on both sides of the welded joint under testing in the place of its intersections.

3.3.4 The extent of welded joints testing by radiographic or ultrasonic methods for prototype objects built by the firm (manufacturer), as well as in the course of repair, modernization and conversion, may be brought up from the value given in [Table 3.3.1](#), if requested so by the Register or the designer of the object.

3.3.5 When structural elements are welded into a rigid contour structure (cutouts where the relation of the minimum cutout size to the plating thickness is below 60), the butt and T-joints in special and primary structures shall be tested over the whole their length and in secondary structures over at least 20 % of the length with the use of radiographic or ultrasonic methods.

3.3.6 The testing of welded joints in structures subjected to treatment by pressure (bending, forming, etc.) by radiographic or ultrasonic methods shall be carried out over the whole length of welded joints in such structures after treatment by pressure.

If the above structures are subject to heat treatment after the pressure treatment, the radio-graphic or ultrasonic testing shall be performed after the heat treatment.

3.3.7 In technically feasible cases, such as welding of joints with thickness of 20 mm and above performed by automatic submerged arc welding machines, the Register may require ultrasonic testing of special and primary structures over the whole length of the welded joint for detection only of cross cracks in the welded joint and zone adjacent to the welded joint.

3.3.8 The welded joints where stresses throughout the thickness may occur shall be subjected to ultrasonic testing aimed at detection and evaluation of discontinuities in the base metal after completion of the welding.

The documentation on ultrasonic testing of the base metal in the zone adjacent to the welded joint shall be approved by the Register on the basis of the previous testing.

3.4 EVALUATION OF WELDED JOINT QUALITY

3.4.1 The criteria for evaluation of welded joint quality in structures of MODU shall comply with the requirements of norms and standards agreed with the Register, as well as with the requirements of 3.4, Part XIV "Welding" of the RS Rules/C.

Unless otherwise specified, the quality of welded joints shall meet the requirements of [Table 3.4.1](#).

Table 3.4.1

Categories of structures	Minimum quality level according to ISO 5817:2014	
Special		B
Primary		B
Secondary		C

Russian Maritime Register of Shipping

Rules for the Classification and Construction of Mobile Offshore Drilling Units

**Part XIII
Welding**

FAI "Russian Maritime Register of Shipping"
7, Litera A, Millionnaya Ulitsa,
St. Petersburg, 191181,
www.rs-class.org/en/