

RUSSIAN MARITIME REGISTER OF SHIPPING

---

# RULES

FOR THE EQUIPMENT  
OF SEA-GOING SHIPS



# RULES

FOR THE CARGO HANDLING GEAR  
OF SEA-GOING SHIPS



# LOAD LINE RULES

FOR SEA-GOING SHIPS



Saint-Petersburg  
Edition 2008

**LIST OF CIRCULAR LETTERS AMENDING/SUPPLEMENTING NORMATIVE DOCUMENT**

(Normative document No. and title)

| Item No. | Circular letter No., date of approval | List of amended and supplemented paras |
|----------|---------------------------------------|--|
|          |                                       |  |

Rules for the Equipment of Sea-Going Ships, Rules for the Cargo Handling Gear of Sea-Going Ships and Load Line Rules for Sea-Going Ships of Russian Maritime Register of Shipping have been approved in accordance with established approval procedure and come into force since 1 October 2008.

The present twelfth edition of the Rules is based on the eleventh edition of 2007 taking into account additions and amendments developed immediately before publication.

The unified requirements, interpretations and recommendations of the International Association of Classification Societies (IACS) and the relevant resolutions of the International Maritime Organization (IMO) have been taken into consideration.

All the above Rules have been published in a single book which includes also "General Regulations for the Classification and Other Activity".

*The present twelfth edition of the Rules, as compared with the previous edition of 2007, contains the following amendments:*

## **GENERAL REGULATIONS FOR THE CLASSIFICATION AND OTHER ACTIVITY**

Chapter 1.3: Rules for the Prevention of Pollution from Ships have been deleted from list of rules used by RS in connection with expiration of their validity (since 1st January 2007).

## **RULES FOR THE EQUIPMENT OF SEA-GOING-SHIPS**

### **PART I. SURVEY REGULATIONS**

Chapter 2.3 "Periodical surveys" — List of items to be surveyed has been supplemented in compliance with the IMO MSC/Circ. 955.

### **PART II. LIFE-SAVING APPLIANCES**

1. Requirements of IMO Resolutions MSC.216(82) and MSC.218(82) have been introduced.
2. Provisions of the IACS Unified Interpretation SC215 (Feb. 2007) have been accounted for.
3. New requirements to provision of fishing vessels with immersion suits have been introduced.
4. Requirements to communications have been specified.

### **PART III. SIGNAL MEANS**

There are no amendments and supplements.

### **PART IV. RADIO EQUIPMENT**

Editorial amendments have been made.

### **PART V. NAVIGATIONAL EQUIPMENT**

Amendments and supplements introduced in Part V "Navigational Equipment" of Rules for the Equipment of Sea-Going Ships are as follows:

in accordance with the provisions of IMO Resolution MSC.202(81) the requirements to installation period of system of long-range identification and tracking of ships have been introduced;

in accordance with the provisions of IMO Resolution MSC.232(82) the performance standards and functional requirements for electronic chart display and information systems (ECDIS) have been revised, which will apply to this equipment, if installed on or after 1 January 2009;

performance standards and functional requirements for shipborne receiver equipment of the radionavigational systems have been revised and supplemented. The supplements are based on the provisions of IMO Resolution MSC.233(82), which specifies the requirements for shipborne Galileo receiver equipment;

taking into account the provisions of IMO Resolution MSC.210(81) the performance standards and functional requirements for the system of long-range identification and tracking of ships have been developed;

requirements for shipborne voyage data recorders (VDRs) and shipborne simplified voyage data recorders (S-VDRs) have been supplemented in respect of unification of the stored data extracting procedure, as specified in provisions of IMO Resolutions MSC.214(81);

requirements for the presentation of navigation-related information on shipborne navigational displays have been developed considering the provisions of IMO Resolution MSC.191(79);

results of the RS research activities-40/2007 have been accounted for;

some editorial amendments and supplements have been introduced, which specify the requirements.

## **RULES FOR THE CARGO-HANDLING GEAR OF SEA-GOING SHIPS**

There are no amendments and supplements.

## **LOAD LINE RULES FOR SEA-GOING SHIPS**

Editorial amendments have been made:

para 1.1.1.4: text of the second paragraph has been brought in line with Regulation 2 (6) of IMO MSC 143 (77);

para 4.2.2 has been supplemented with the necessary explanation and two figures.

# CONTENTS

## GENERAL REGULATIONS FOR THE CLASSIFICATION AND OTHER ACTIVITY

|   |    |   |    |
|---|----|---|----|
| <b>1 General</b> . . . . .                      | 10 | 2.2 Surveys during the manufacture of materials and products . . . . .                                | 14 |
| 1.1 Application . . . . .                       | 10 | 2.3 Surveys of ships and FOP under construction, reconstruction and conversion . . . . .              | 14 |
| 1.2 Classification and other activity . . . . . | 10 | 2.4 Surveys of ships and FOP in service . . . . .   | 15 |
| 1.3 Rules . . . . .                             | 11 | 2.5 Surveys in compliance with the requirements of international conventions and agreements . . . . . | 15 |
| 1.4 Documents . . . . .                         | 12 |   |    |
| 1.5 The Register responsibilities . . . . .     | 13 |   |    |
| 1.6 Confidentiality . . . . .                   | 13 |   |    |
| <b>2 Surveys</b> . . . . .                      | 14 |   |    |
| 2.1 General . . . . .                           | 14 |   |    |

## RULES FOR THE EQUIPMENT OF SEA-GOING SHIPS

### PART I. SURVEY REGULATIONS

|   |    |  |    |
|---|----|--|----|
| <b>1 General</b> . . . . .  | 18 | 2.5 Stowage of rescue boats . . . . .                                      | 32 |
| 1.1 Application . . . . .   | 18 | 2.6 Stowage of marine evacuation systems . . . . .                         | 32 |
| 1.2 Definitions and explanations . . . . .  | 18 | 2.7 Survival craft launching and recovery arrangements . . . . .           | 32 |
| <b>2 Surveys of equipment of ships in service</b> . . . . .   | 19 | 2.8 Rescue boat embarkation, launching and recovery arrangements . . . . . | 33 |
| 2.1 General . . . . .   | 19 | 2.9 Line-throwing appliances . . . . .                                     | 33 |
| 2.2 Initial survey . . . . .  | 19 | <b>3 Requirements for passenger ships</b> . . . . .                        | 34 |
| 2.3 Periodical surveys . . . . .  | 19 | 3.1 Survival craft and rescue boats . . . . .                              | 34 |
| 2.4 Occasional surveys . . . . .  | 19 | 3.2 Personal life-saving appliances . . . . .                              | 35 |
| 2.5 Survey of equipment of the ships in service which are not registered by the Register . . . . .    | 19 | 3.3 Survival craft and rescue boat embarkation arrangements . . . . .      | 35 |
| <b>3 Technical documentation of ship's equipment</b> . . . . .  | 22 | 3.4 Additional requirements for ro-ro passenger ships . . . . .            | 36 |
| 3.1 General . . . . .   | 22 | <b>4 Requirements for cargo ships</b> . . . . .                            | 37 |
| 3.2 Technical design and working plan documentation on equipment of ship under construction . . . . . | 22 | 4.1 Survival craft and rescue boats . . . . .                              | 37 |
| 3.3 Technical documentation for equipment of ship subject to conversion or reconstruction . . . . .   | 23 | 4.2 Personal life-saving appliances . . . . .                              | 38 |
| 3.4 Working documentation on equipment of ship under construction . . . . .                           | 23 | 4.3 Survival craft embarkation and launching arrangements . . . . .        | 39 |

### PART II. LIFE-SAVING APPLIANCES

|  |    |   |    |
|--|----|---|----|
| <b>1 General</b> . . . . .                             | 25 | <b>5 Requirements for other types of ships</b> . . . . .      | 39 |
| 1.1 Application . . . . .                              | 25 | 5.1 Fishing vessels . . . . .                                 | 39 |
| 1.2 Definitions and explanations . . . . .             | 25 | 5.2 Special purpose ships . . . . .                           | 39 |
| 1.3 Scope of survey . . . . .                          | 26 | 5.3 Specialized ships . . . . .                               | 40 |
| <b>2 Requirements for all types of ships</b> . . . . . | 28 | 5.4 Berth-connected ships . . . . .                           | 40 |
| 2.1 Communications . . . . .                           | 28 | <b>6 Requirements for life-saving appliances</b> . . . . .    | 40 |
| 2.2 Personal life-saving appliances . . . . .          | 29 | 6.1 General requirements for life-saving appliances . . . . . | 40 |
| 2.3 Arrangement of survival craft . . . . .            | 30 | 6.2 Lifebuoys . . . . .                                       | 41 |
| 2.4 Stowage of survival craft . . . . .                | 31 | 6.3 Lifejackets . . . . .                                     | 41 |
|  |    | 6.4 Immersion suits . . . . .                                 | 42 |
|  |    | 6.5 Anti-exposure suits . . . . .                             | 43 |
|  |    | 6.6 Thermal protective aids . . . . .                         | 43 |
|  |    | 6.7 Pyrotechnic signal means . . . . .                        | 44 |
|  |    | 6.8 Liferrafts . . . . .                                      | 44 |
|  |    | 6.9 Inflatable liferafts . . . . .                            | 47 |
|  |    | 6.10 Rigid liferafts . . . . .                                | 49 |
|  |    | 6.11 Canopied reversible liferafts . . . . .                  | 50 |

|   |    |   |     |
|---|----|---|-----|
| 6.12 Self-righting liferafts . . . . .  | 50 | 4.7 Devices for hoisting and storing signal shapes . . . . .  | 89  |
| 6.13 Lifeboats . . . . .  | 50 | 4.8 Arrangements for storing pyrotechnic signal means . . . . .   | 89  |
| 6.14 Partially enclosed lifeboats . . . . .   | 56 | 4.9 Arrangements for storing spare lights . . . . .   | 89  |
| 6.15 Totally enclosed lifeboats . . . . .   | 56 | <b>5 Additional signal means for ships of river-sea navigation . . . . .</b>  | 89  |
| 6.16 Free-fall lifeboats . . . . .  | 57 | 5.1 General . . . . .   | 89  |
| 6.17 Lifeboats with a self-contained air support system . . . . .   | 58 | 5.2 Equipment of ships with signal means . . . . .  | 89  |
| 6.18 Fire-protected lifeboats . . . . .   | 58 | 5.3 Technical requirements for signal means . . . . .   | 90  |
| 6.19 Rescue boats . . . . .   | 58 | 5.4 Fitting of signal means on board . . . . .  | 90  |
| 6.20 Launching and embarkation appliances . . . . .   | 61 | 5.5 Storage of signal flags . . . . .   | 91  |
| 6.21 Line-throwing appliances . . . . .   | 65 |   |     |
| 6.22 General alarm and public address system . . . . .  | 65 |   |     |
| Appendix 1. Recommendation on the use and fitting of retro-reflective materials on life-saving appliances . . . . .                                       | 67 |   |     |
| Appendix 2. Symbols for use in accordance with regulation III/9.2.3 of the 1974 SOLAS Convention, as amended in 1983 . . . . .                            | 69 |   |     |
| <b>PART III. SIGNAL MEANS</b>   |    |   |     |
| <b>1 General . . . . .</b>  | 73 | <b>PART IV. RADIO EQUIPMENT</b>   |     |
| 1.1 Application . . . . .   | 73 | <b>1 General . . . . .</b>  | 92  |
| 1.2 Definitions and explanations . . . . .  | 73 | 1.1 Application . . . . .   | 92  |
| 1.3 Scope of survey . . . . .   | 74 | 1.2 Definitions and explanations . . . . .  | 92  |
| 1.4 Division of ships into groups . . . . .   | 74 | 1.3 Scope of survey . . . . .   | 94  |
| <b>2 Equipment of ships with signal means . . . . .</b>   | 74 | <b>2 Functional requirements for radio equipment, its composition, maintenance and repair . . . . .</b>   | 96  |
| 2.1 General . . . . .   | 74 | 2.1 Functional requirements . . . . .   | 96  |
| 2.2 Equipment of Group I ships . . . . .  | 74 | 2.2 List of radio equipment . . . . .   | 96  |
| 2.3 Equipment of Group II ships . . . . .   | 76 | 2.3 Sources of power . . . . .  | 99  |
| 2.4 Additional signal means for towing or pushing ships, ships restricted in their ability to manoeuvre, pilot, fishing and air-cushion ships . . . . .   | 77 | 2.4 Aerials . . . . .   | 101 |
| 2.5 Equipment of ships with pyrotechnic signal means . . . . .  | 77 | 2.5 Spare parts and supply . . . . .  | 102 |
| 2.6 Berth-connected ships . . . . .   | 78 | 2.6 Maintenance and repair of radio equipment . . . . .   | 102 |
| <b>3 Construction of signal means . . . . .</b>   | 78 | 2.7 Documenting (radio log) . . . . .   | 103 |
| 3.1 Navigation lights . . . . .   | 78 | <b>3 Spaces for radio equipment, its arrangement, cabling . . . . .</b>   | 104 |
| 3.2 Flashing lights . . . . .   | 81 | 3.1 General . . . . .   | 104 |
| 3.3 Sound signal means . . . . .  | 82 | 3.2 Special space for arrangement of radio equipment (radioroom) . . . . .  | 104 |
| 3.4 Signal shapes . . . . .   | 83 | 3.3 Accumulator battery room . . . . .  | 105 |
| 3.5 Pyrotechnic signal means . . . . .  | 83 | 3.4 Arrangement of radio equipment on navigating bridge . . . . .   | 106 |
| <b>4 Fitting of signal means on board . . . . .</b>   | 84 | 3.5 Arrangement of two-way VHF radiotelephone apparatus and two-way VHF radiotelephone apparatus intended for communications with aircrafts . . . . . | 107 |
| 4.1 General . . . . .   | 84 | 3.6 Location of emergency position-indicating radio beacons . . . . .   | 108 |
| 4.2 Main navigation lights in ships of Group I . . . . .  | 84 | 3.7 Location of radar transponders . . . . .  | 108 |
| 4.3 Main navigation lights in ships of Group II . . . . .   | 86 | 3.8 Arrangement of equipment and cabling of public address system . . . . .   | 108 |
| 4.4 Additional lights in towing or pushing ships, fishing and pilot ships, ships restricted in their ability to manoeuvre and air-cushion ships . . . . . | 86 | 3.9 Cabling . . . . .   | 109 |
| 4.5 Flashing lights . . . . .   | 88 | <b>4 Aerials and earthing . . . . .</b>   | 110 |
| 4.6 Sound signal means . . . . .  | 88 | 4.1 General . . . . .   | 110 |
|   |    | 4.2 MF and MF/HF-aerial . . . . .   | 111 |
|   |    | 4.3 VHF-aerial . . . . .  | 111 |
|   |    | 4.4 General requirements to antenna system of INMARSAT ship earth station . . . . .   | 111 |
|   |    | 4.5 Antenna system of INMARSAT-C ship earth station and EGC receiver . . . . .  | 111 |

|   |   |            |
|---|---|------------|
| 4.6   | Lead-in and interior wiring of aerials . . .  | 111        |
| 4.7   | Earthing . . . . .  | 112        |
| <b>5</b>  | <b>Technical and operational requirements for radio equipment . . . . .</b>   | <b>113</b> |
| 5.1   | General . . . . .   | 113        |
| 5.2   | General requirements for equipment of radio communication facilities . . . . .  | 118        |
| <b>6</b>  | <b>Radio communication facilities . . . . .</b>   | <b>121</b> |
| 6.1   | VHF radio installation . . . . .  | 121        |
| 6.2   | MF radio installation . . . . .   | 123        |
| 6.3   | MF/HF radio installation . . . . .  | 125        |
| 6.4   | INMARSAT ship earth station . . . . .   | 127        |
| 6.5   | Direct-printing apparatus of improved fidelity . . . . .  | 127        |
| 6.6   | Terminal printing device . . . . .  | 127        |
| 6.7   | Facsimile terminal device . . . . .   | 127        |
| 6.8   | Integrated radio communication system when used in the GMDSS . . . . .  | 128        |
| 6.9   | VHF radiotelephone station within frequency band of 300,025 MHz to 300,500 MHz and 336,025 MHz to 336,500 MHz . . . . . | 128        |
| 6.10  | Radiotelephone station for interior communication. . . . .  | 129        |
| 6.11  | Two-way VHF radiotelephone apparatus for communications with aircrafts . . . . .  | 129        |
| 6.12  | Stationary two-way VHF radiotelephone apparatus for communications with aircrafts . . . . .                             | 130        |
| <b>7</b>  | <b>Ship security equipment. . . . .</b>   | <b>130</b> |
| 7.1   | Ship security alert system . . . . .  | 130        |
| 7.2   | Ship security surveillance TV system . . . . .  | 131        |
| <b>8</b>  | <b>Facilities for reception of maritime safety information . . . . .</b>  | <b>132</b> |
| 8.1   | NAVTEX receiver . . . . .   | 132        |
| 8.2   | Enhanced group calling receiver . . . . .   | 133        |
| 8.3   | HF direct-printing radiotelegraph receiver for reception of maritime safety information . . . . .                       | 134        |
| <b>9</b>  | <b>Emergency position-indicating radio beacons. . . . .</b>   | <b>135</b> |
| 9.1   | General . . . . .   | 135        |
| 9.2   | COSPAS-SARSAT satellite emergency position-indicating radio beacons . . . . .   | 136        |
| 9.3   | VHF emergency position-indicating radio beacons . . . . .   | 136        |
| <b>10</b>   | <b>Ship and survival craft radar transponders . . . . .</b>   | <b>137</b> |
| 10.1  | General . . . . .   | 137        |
| <b>11</b>   | <b>Public address system. . . . .</b>   | <b>138</b> |
| 11.1  | General . . . . .   | 138        |
| <b>12</b>   | <b>Survival craft radio equipment . . . . .</b>   | <b>138</b> |
| 12.1  | Radar transponders . . . . .  | 138        |
| 12.2  | Two-way VHF radiotelephone apparatus . . . . .  | 138        |
| <b>13</b>   | <b>Float-free release and activation arrangements for emergency radio equipment . . . . .</b>                           | <b>140</b> |
| 13.1  | General . . . . .   | 140        |
| Appendix. Information for determination of areas of navigation. . . . . |   | 141        |

## PART V. NAVIGATIONAL EQUIPMENT

|          |  |            |
|----------|--|------------|
| <b>1</b> | <b>General . . . . .</b>   | <b>142</b> |
| 1.1      | Application . . . . .  | 142        |
| 1.2      | Definitions and explanations . . . . .   | 143        |
| 1.3      | Scope of survey . . . . .  | 146        |
| <b>2</b> | <b>Navigational equipment of self-propelled sea-going ships. . . . .</b>   | <b>148</b> |
| 2.1      | Division of ships into groups . . . . .  | 148        |
| 2.2      | List of navigational equipment . . . . .   | 148        |
| 2.3      | Sources of power . . . . .   | 150        |
| 2.4      | Aerials . . . . .  | 151        |
| 2.5      | Spare parts and supply . . . . .   | 151        |
| 2.6      | Maintenance of and repairs to navigational equipment . . . . .   | 151        |
| <b>3</b> | <b>Spaces intended for installation of navigational equipment. Arrangement of navigational equipment and cabling . . . . .</b> | <b>152</b> |
| 3.1      | General . . . . .  | 152        |
| 3.2      | Navigating bridge . . . . .  | 152        |
| 3.3      | Generator room . . . . .   | 155        |
| 3.4      | Accumulator battery room . . . . .   | 155        |
| 3.5      | Compartment intended for installation of master gyrocompass . . . . .  | 155        |
| 3.6      | Log trunk and/or echo sounder trunk . . . . .  | 156        |
| 3.7      | Arrangement of navigational equipment on board ship . . . . .  | 156        |
| 3.8      | Cabling . . . . .  | 160        |
| <b>4</b> | <b>Aerials and earthing . . . . .</b>  | <b>161</b> |
| 4.1      | General . . . . .  | 161        |
| 4.2      | Radar aerials . . . . .  | 161        |
| 4.3      | Aerials of universal automatic identification system (AIS) . . . . .   | 161        |
| 4.4      | Aerials of radionavigation system receivers . . . . .  | 161        |
| 4.5      | Earthing. . . . .  | 162        |
| <b>5</b> | <b>Technical and operational requirements for navigational equipment . . . . .</b>   | <b>162</b> |
| 5.1      | General . . . . .  | 162        |
| 5.2      | Magnetic compass . . . . .   | 165        |
| 5.3      | Gyrocompass . . . . .  | 167        |
| 5.4      | Log . . . . .  | 168        |
| 5.5      | Echo sounder . . . . .   | 170        |
| 5.6      | Rate-of-turn indicators . . . . .  | 171        |
| 5.7      | Radar . . . . .  | 171        |
| 5.8      | Radar reflector . . . . .  | 179        |
| 5.9      | Radiobeacon station. . . . .   | 183        |
| 5.10     | Transmitting heading device. . . . .   | 185        |
| 5.11     | Radionavigation system receivers . . . . .   | 186        |
| 5.12     | Combined ship control desks . . . . .  | 190        |
| 5.13     | Integrated navigation system . . . . .   | 192        |
| 5.14     | Unified timing system . . . . .  | 193        |
| 5.15     | Electronic chart display and information system. . . . .   | 193        |
| 5.16     | Heading control system . . . . .   | 199        |
| 5.17     | Ship's track control system . . . . .  | 201        |



|  |     |  |            |
|--|-----|--|------------|
| 5.18 Universal shipborne automatic identification system (AIS) . . . . . | 202 | 5.23 Long-range identification and tracking systems (LRIT) equipment . . . . .   | 208        |
| 5.19 Sound reception system . . . . .                                    | 204 | <b>6 Performance standards for the presentation of navigation-related information on shipborne navigation displays . . . . .</b> | <b>209</b> |
| 5.20 Voyage data recorder (VDR) . . . . .                                | 204 | Appendix. Rule standard for bridge design, equipment arrangement and procedures (BDEAP) . . . . .                                | 215        |
| 5.21 Simplified voyage data recorder (S-VDR) . . . . .                   | 205 |  |            |
| 5.22 Bridge navigational watch alarm system (BNWAS) . . . . .            | 207 |  |            |

## RULES FOR THE CARGO HANDLING GEAR OF SEA-GOING SHIPS

|  |            |   |            |
|--|------------|---|------------|
| <b>1 General . . . . .</b>   | <b>251</b> | 7.4 Counterweight. . . . .  | 281        |
| 1.1 Application . . . . .  | 251        | 7.5 Buffers . . . . .   | 281        |
| 1.2 Definitions and explanations . . . . .   | 251        | 7.6 Gripping devices . . . . .  | 281        |
| 1.3 Scope of survey . . . . .  | 253        | 7.7 Overspeed governors . . . . .   | 282        |
| 1.4 Technical documentation. . . . .   | 259        | 7.8 Ropes, details of cable run and fastening of ropes . . . . .  | 282        |
| 1.5 General technical requirements. . . . .  | 260        | 7.9 Winch . . . . .   | 282        |
| 1.6 Special requirements . . . . .   | 264        | 7.10 Electric drive, control, signalling and lighting . . . . .   | 282        |
| <b>2 Calculations . . . . .</b>  | <b>264</b> | <b>8 Ship's elevating platforms . . . . .</b>   | <b>285</b> |
| 2.1 General . . . . .  | 264        | 8.1 General . . . . .   | 285        |
| 2.2 Design loads and stresses . . . . .  | 264        | 8.2 Calculation . . . . .   | 286        |
| 2.3 Allowable stresses, safety factors and stability margin . . . . .                            | 265        | <b>9 Gear and ropes . . . . .</b>   | <b>288</b> |
| <b>3 Materials and welding . . . . .</b>   | <b>267</b> | 9.1 General . . . . .   | 288        |
| 3.1 Materials. . . . .   | 267        | 9.2 Fixed gear. . . . .   | 288        |
| 3.2 Welding . . . . .  | 268        | 9.3 Interchangeable components. . . . .   | 288        |
| <b>4 Ship derricks . . . . .</b>   | <b>269</b> | 9.4 Loose gear . . . . .  | 289        |
| 4.1 General . . . . .  | 269        | 9.5 Ropes . . . . .   | 290        |
| 4.2 Calculation. . . . .   | 270        | <b>10 Examinations, inspections and testing . . . . .</b>   | <b>290</b> |
| 4.3 Cargo masts . . . . .  | 271        | 10.1 General . . . . .  | 290        |
| 4.4 Derrick booms. . . . .   | 271        | 10.2 Testing of interchangeable components and loose gear. . . . .  | 291        |
| 4.5 Cargo winches and reels . . . . .  | 272        | 10.3 Testing and examinations of mounted cargo handling gear . . . . .  | 293        |
| <b>5 Ship's cranes and hoists. . . . .</b>   | <b>272</b> | 10.4 Periodical surveys, inspections and tests . . . . .  | 296        |
| 5.1 General . . . . .  | 272        | 10.5 Occasional examinations and tests. . . . .   | 296        |
| 5.2 Calculation. . . . .   | 272        | 10.6 Limits of wear. . . . .  | 297        |
| 5.3 Metal structures . . . . .   | 273        | <b>11 Documentation and marking . . . . .</b>   | <b>298</b> |
| 5.4 Machinery . . . . .  | 273        | 11.1 Documents . . . . .  | 298        |
| 5.5 Safety devices . . . . .   | 274        | 11.2 Marking and stamping . . . . .   | 299        |
| 5.6 Counterbalances . . . . .  | 274        | <b>12 Technical supervision of cargo handling gear in use. . . . .</b>  | <b>302</b> |
| 5.7 Mobile cranes and hoists. . . . .  | 274        | 12.1 General . . . . .  | 302        |
| <b>6 Upper structures of floating cranes and crane ships. Cranes on floating docks . . . . .</b> | <b>275</b> | 12.2 Periodical examinations of interchangeable components and loose gear, and ropes by ship's administration . . . . .                                   | 302        |
| 6.1 General . . . . .  | 275        | Appendix. Nomenclature of main structures, machinery and gear of cargo handling gear subject to survey by the Register ( to 1.3.3 of the Rules) . . . . . | 302        |
| 6.2 Calculation. . . . .   | 275        |   |            |
| 6.3 Metal structures, drums, blocks . . . . .  | 276        |   |            |
| 6.4 Tests . . . . .  | 276        |   |            |
| <b>7 Ship's lifts . . . . .</b>  | <b>277</b> |   |            |
| 7.1 General . . . . .  | 277        |   |            |
| 7.2 Calculation. . . . .   | 277        |   |            |
| 7.3 Metal structures . . . . .   | 279        |   |            |

## LOAD LINE RULES FOR SEA-GOING SHIPS

|          |   |     |   |  |     |
|----------|---|-----|---|--|-----|
| <b>1</b> | <b>General</b>  | 307 | <b>5</b>                                    | <b>Special requirements for ships engaged in international voyages which are assigned timber freeboards</b>    | 344 |
| 1.1      | Scope of application  | 307 | 5.1   | Conditions of assignment of timber freeboards  | 344 |
| 1.2      | Definitions and explanations  | 308 | 5.2   | Calculation of minimum timber freeboards   | 345 |
| 1.3      | Areas of navigation   | 311 | <b>6</b>                                    | <b>Load lines of ships of 24 m in length and more not engaged in international voyages and fishing vessels</b> | 346 |
| 1.4      | Scope of survey and certificates  | 312 | 6.1   | Application  | 346 |
| 1.5      | General technical requirements  | 314 | 6.2   | Marking  | 346 |
| <b>2</b> | <b>Load line marking on ships engaged in international voyages</b>                      | 315 | 6.3   | Conditions of assignment of freeboards   | 347 |
| 2.1      | Deck line and load line mark  | 315 | 6.4   | Assignment of minimum freeboards   | 348 |
| 2.2      | Lines to be used with load line mark  | 316 | 6.5   | Special requirements for ships assigned timber freeboards  | 349 |
| 2.3      | Load line designation and marking   | 318 | <b>7</b>                                    | <b>Load lines of mobile offshore drilling units</b>  | 350 |
| <b>3</b> | <b>Conditions of assignment of freeboard for ships engaged in international voyages</b> | 319 | 7.1   | General  | 350 |
| 3.1      | Strength and stability of ship  | 319 | 7.2   | Marking  | 350 |
| 3.2      | Arrangement and means of closure of openings in hull and superstructures                | 319 | 7.3   | Minimum freeboards and conditions of their assignment  | 350 |
| 3.3      | Protection of the crew  | 327 | <b>8</b>                                    | <b>Load lines of ships of less than 24 m in length</b>   | 351 |
| 3.4      | Special conditions of assignment for type A ships                                       | 329 | 8.1   | Application  | 351 |
| <b>4</b> | <b>Assignment of minimum freeboards for ships engaged in international voyages</b>      | 330 | 8.2   | Marking  | 351 |
| 4.1      | Types of ships and freeboard tables   | 330 | 8.3   | Conditions of assignment of freeboards   | 351 |
| 4.2      | Superstructures and trunks  | 334 | 8.4   | Assignment of minimum freeboards   | 352 |
| 4.3      | Sheer   | 337 | Appendix. Zones, areas and seasonal periods |  | 353 |
| 4.4      | Corrections to tabular freeboard  | 340 |   |  |     |
| 4.5      | Assignment of minimum freeboard   | 343 |   |  |     |

# GENERAL REGULATIONS FOR THE CLASSIFICATION AND OTHER ACTIVITY

---

## 1 GENERAL

### 1.1 APPLICATION

**1.1.1** The present General Regulations for the Classification and Other Activity cover the activity of Russian Maritime Register of Shipping<sup>1</sup> during:

consideration and agreement of technical documentation for the construction, repair, conversion and modernization of ships and fixed offshore platforms<sup>2</sup>, for the manufacture of materials and products for ships and FOP;

technical supervision of the construction, repair, conversion and modernization of ships and FOP;

survey of ships and FOP in service.

The classification activity of the Register is based on Regulations Concerning the Classification of Ships and Fixed Offshore Platforms.

The Register activity in other spheres is regulated by relevant documents.

### 1.2 CLASSIFICATION AND OTHER ACTIVITY

**1.2.1** The Register is a state institution which carries out surveys of and assigns class to civil ships. The Register is a member to International Association of Classification Societies (IACS) and uses IACS resolutions and the provisions of IACS Code of Ethics in its activity.

The Register maintains a quality system complying with the requirements of IACS and with the applicable requirements of ISO 9001 which is confirmed by the relevant IACS Certificate issued on the basis of appropriate audits.

Besides, being authorized by the government of the Russian Federation<sup>3</sup> and by the governments of other countries to act on their behalf, the Register carries out surveys within its terms of reference for compliance with the requirements of international conventions and agreements to which the above governments are parties.

**1.2.2** The Register establishes technical requirements ensuring safe operation of ships and FOP in accordance with their purpose, safety of life at sea and safe carriage of goods by sea and inland waterways as well as pollution prevention from ships; it

carries out surveys for compliance with the above requirements, assigns class to ships and FOP, determines the net and gross tonnage of sea-going ships and FOP and the tonnage measurement characteristics of inland navigation ships in its registry.

**1.2.3** The Register activity is based on the rules published by that body and is aimed at determining whether ships and FOP in its registry as well as materials and products intended for the construction and repair of ships and FOP and their equipment comply with the rules and with additional requirements. The application and fulfillment of the rules and additional requirements are the obligation of design bureaus, shipowners, shipyards and manufacturers of materials and products to which the requirements of the rules apply.

The interpretation of the requirements of the Register rules and other normative documents is within the competence of the Register only.

The Register activity does not substitute for the state surveillance of merchant shipping carried out by both the federal body of executive power responsible for transport and the federal body of executive power responsible for fisheries, nor does it interfere with shipowners, shipyards or manufacturers technical control.

**1.2.4** Classification activity of the Register covers the following:

**.1** development and publication of rules and other normative documents;

**.2** consideration and approval of technical documentation;

**.3** construction, conversion, modernization and repair surveys of ships and FOP, manufacture and repair surveys of products as well as manufacture surveys of materials for shipbuilding;

**.4** surveys of ships and FOP in service;

**.5** assignment, renewal and reinstatement of class;

**.6** drawing up and issue of the Register certificates.

**1.2.5** Other activity of the Register covers:

**.1** construction, conversion, modernization and repair surveys of ships and FOP as well as manufacture and repair surveys of products and manufacture surveys of materials for shipbuilding for compliance with the provisions of international conventions and agreements;

**.2** ship and FOP registry;

**.3** investigation and registry of accidents aboard ships;

**.4** initiative surveys of ships;

---

<sup>1</sup> Hereinafter referred to as "the Register".

<sup>2</sup> Hereinafter referred to as "FOP".

<sup>3</sup> Hereinafter referred to as "RF".

.5 judgement in technical matters;  
 .6 other activity not connected with classification of ships and FOP.

**1.2.6** The Register carries out classification of the following types of sea-going ships, ships of inland navigation and fixed offshore platforms both under construction and in service:

.1 passenger ships and tankers, tugs, ships designed for the carriage of dangerous goods, sea-going pleasure boats with passenger capacity above 12, all these irrespective of their main engine power and gross tonnage;

.2 self-propelled ships not mentioned under 1.2.6.1 with main engine power of 55 kW and above;

.3 ships not mentioned under 1.2.6.1 and 1.2.6.2 with a gross tonnage of 80 and above or with the total power of prime movers of 100 kW and above;

.4 fixed offshore platforms of different purposes.

**1.2.7** The Register carries out surveys of ship refrigerating plants from the point of view of ship's safety, safe carriage of goods, absence of the ozone-destructive effect of refrigerants upon the environment, as well as the classification of ship refrigerating plants.

**1.2.8** The Register carries out surveys of ship cargo-handling gear of 1 t lifting capacity and upwards.

**1.2.9** On special agreement, the Register may carry out surveys of ships, installations or arrangements not specified in 1.2.6 to 1.2.8.

**1.2.10** The technological and special arrangements of fishing vessels, cable layers, vessels of dredging fleet and special purpose ships are not subject to the Register survey except the equipment specified in the relevant parts of the rules.

**1.2.11** Draft standards and other normative documents related to the Register activity are considered and approved by the Register.

**1.2.12** The Register may initiate examinations of technical issues related to its activity or participate therein.

**1.2.13** The Register of Ships is published by the Register, containing the particulars of self-propelled sea-going ships of 100 gross tonnage and upwards classed with the Register.

**1.2.14** For services rendered by the Register fees are charged according to the scales of fees of the Register. If the commitments to the Register including those on payment for its services fail to be performed or are improperly performed, the Register is entitled not to assign a class or, where a class has already been assigned, to suspend or withdraw it from the ship in connection with which the commitments to the Register, including those on payment for its services failed to be performed or were improperly performed, and to withdraw (make an entry indicating cessation of validity) the certificates issued by the Register.

### 1.3 RULES

#### 1.3.1 Rules to be applied.

**1.3.1.1** The following rules are developed, published and used by the Register:

.1 Rules for the Classification and Construction of Sea-Going Ships;

.2 Rules for the Equipment of Sea-Going Ships;

.3 Load Line Rules for Sea-Going Ships;

.4 Rules for the Cargo-Handling Gear of Sea-Going Ships;

.5 Rules for the Classification Surveys of Ships in Service;

.6 Rules for the Classification and Construction of Inland Navigation Ships (for the Danube);

.7 Rules for the Classification, Construction and Equipment of Mobile Offshore Drilling Units (MODU) and Fixed Offshore Platforms (FOP);

.8 Rules for the Classification and Construction of Chemical Tankers;

.9 Rules for the Classification and Construction of Nuclear Ships and Floating Facilities;

.10 Rules for the Classification and Construction of Nuclear Support Vessels;

.11 Rules for the Classification and Construction of Gas Carriers;

.12 Rules for the Classification and Construction of Manned Submersibles, Ship's Diving Systems and Passenger Submersibles;

.13 Rules for the Classification and Technical Supervision of Sea-Going Pleasure Boats;

.14 Rules for the Classification and Construction of High-Speed Craft;

.15 Rules for the Classification and Construction of Type A WIG Craft;

.16 Rules for the Carriage of Grain;

.17 Rules for the Construction of Hulls of Sea-Going Ships and Floating Facilities Using Reinforced Concrete;

.18 Rules for the Tonnage Measurement of Sea-Going Ships;

.19 Rules for the Tonnage Measurement of Inland Navigation Ships;

.20 Rules for Technical Supervision during Construction of Ships and Manufacture of Materials and Products for Ships;

.21 Rules for the Survey of Ship Propulsion Plants for Compliance with Technical Standards of Noxious Substance Emission into the Air;

.22 Rules for the Classification and Construction of Small Sea Fishing Vessels.

**1.3.1.2** Besides the rules mentioned under 1.3.1.1, the following rules are applied in the Register activity:

.1 Rules for the Measurement of Vessels for the Panama Canal;

.2 Rules for the Tonnage Measurement for the Suez Canal;

.3 Rules of the RF River Register;

.4 other external normative documents approved by the Register.

**1.3.1.3** The Register also develops, publishes and uses guidelines on the survey of ships, FOP, materials and products for shipbuilding as well as other guidelines and technical requirements regulating the Register activity in other spheres.

**1.3.2 Application of the rules to ships and FOP under construction, materials and products.**

**1.3.2.1** Newly published rules and amendments thereto come into force on the date stated in the annotation on the back of the title page. Before that date, they shall be considered recommendations.

**1.3.2.2** For newly built ships and FOP the rules or amendments thereto as in effect on the date of signing the contract for construction of a ship (series of sister ships) or the FOP respectively are generally applied.

If the ship/FOP design is submitted to the Register for approval before the date of signing the contract for construction, the Rules or amendments thereto as in effect on the date of the customer's request for the design review are applied. In this case, if the new rules or amendments thereto, according to which the ship/FOP design was approved become effective on the date of signing the contract for construction of a ship/FOP, the design shall be revised for compliance with the above rules or amendments.

**1.3.2.3** Materials and products, technical documentation on which is submitted to the Register for approval after the enforcement of the rules or amendments thereto, shall comply with the requirements of the above rules and amendments.

**1.3.3 Application of rules to ships and FOP in service.**

**1.3.3.1** For ships and FOP in service the requirements of the edition of the rules, according to which the ships and FOP were built, are applied, unless otherwise specified in the subsequent editions of the rules and notices of amendments thereto issued after publication of the above rules.

**1.3.3.2** For ships and FOP in service, classified by the Register for the first time, the requirements of the rules effective for the period of construction of the given ship/FOP considering the requirements of subsequent editions of the rules, which apply to ships and FOP in service.

**1.3.3.3** The scope of application of the newly published rules to ships and FOP in service, repair after an accident or other similar cases, as well as at conversion, shall be specified by the Register con-

sidering practicability and technical feasibility in each particular case.

**1.3.4 Deviations from the Rules.**

**1.3.4.1** The Register may allow to use materials and products, ship structures, FOP or their separate arrangements, other than those required by the rules, provided they are as effective as those specified by the rules. Where ships and FOP covered by international conventions and agreements are concerned, deviations from the requirements of the rules may only be allowed by the Register if they are accepted by the relevant conventions or agreements.

In the above cases, data shall be submitted to the Register enabling to ascertain that the materials, structures and products in question meet the requirements ensuring the ship/FOP safety, safety of life at sea, safe carriage of goods by sea and by inland waterways as well as ecological safety of the environment.

**1.3.4.2** Where the structure of a ship, FOP, machinery, arrangements, installations, equipment and outfit or the materials used cannot be recognized as being adequately verified in service, the Register may require special tests to be held during construction and, in case of a ship in service, may reduce intervals between periodical surveys or extend the scope of these surveys.

If the Register considers it necessary, appropriate restrictive entries may be made in the classification or other certificates issued by the Register and in the Register of Ships. The restrictions are withdrawn subsequent to satisfactory results obtained in service.

## 1.4 DOCUMENTS

**1.4.1** As a result of its activity, the Register issues relevant certificates:

.1 certificates confirming compliance with the requirements of Rules for the Classification and Construction of Sea-Going Ships and rules for the classification and construction of particular types of ships;

.2 seaworthiness certificates stipulated by the Merchant Shipping Code;

.3 certificates stipulated by international conventions and codes;

.4 survey reports serving as the basis for issuing relevant certificates;

.5 certificates for materials and products confirming their compliance with the requirements of the Register rules.

## **1.5 THE REGISTER RESPONSIBILITIES**

**1.5.1** The Register entrusts carrying out inspections to experts adequately skilled and performing their duties with proper diligence.

The Register is responsible for failure to perform or for improper performance of its commitments only when found guilty (by intent or carelessness).

The Register covers the losses to persons entering with it into contractual relations, as stipulated by the Rules, and whose losses result from its failure to perform or improper performance of its contractual commitments due to carelessness, to the amount not exceeding the contract fees determined on the basis of the Register scales of fees and provided solely the causal relationship

has been proved between such failure to perform or improper performance of contractual commitments by the Register and the suffered losses.

## **1.6 CONFIDENTIALITY**

**1.6.1** The Register considers as confidential any information obtained in the course of rendering services and does not provide its contents or copies without prior agreement with the customer to outside organizations except for the following: in cases specified in the Register rules, upon the requirements of the current legislations, upon a decision of the court, on trials and at the request of flag states.

## 2 SURVEYS

### 2.1 GENERAL

**2.1.1** For the surveys to be carried out, the shipowners, administrations of shipyards, manufacturers and other enterprises shall ensure that the Register representatives have the opportunity to carry out ship surveys, as well as free access to all places where materials and products are manufactured and tested, and shall provide all conditions for the surveys to be carried out.

Where necessary, the Register may require to provide the access to surveyed items as well as the conditions for performing the work by Surveyors to the Register together with IACS auditors when the latter carry out audits of the Register quality system.

**2.1.2** Shipowners, shipyards, design bureaus and manufacturers shall fulfil the requirements of the Register or Surveyors to the Register when they are in the course of their duty.

**2.1.3** Any alterations on the part of shipowners, shipyards, design bureaus and manufacturers in respect of ship and FOP materials and structures, as well as products, to which the requirements of the Rules apply shall be approved by the Register before they are put into service.

**2.1.4** Controversial issues arising in connection with the Register activity may be transferred by shipowners, shipyards, manufacturers and other enterprises to the higher Register Branch Office. The judgement of the Register Head Office is final.

**2.1.5** The Register may refuse from a survey in case a shipyard or manufacturer systematically violates the Rules or if the other party to a contract violates it.

**2.1.6** When a material or product proves defective under a valid certificate, the Register may require additional tests or relevant repair to be carried out, and where the defects cannot be repaired, may cancel the certificate.

### 2.2 SURVEYS DURING THE MANUFACTURE OF MATERIALS AND PRODUCTS

**2.2.1** The relevant parts of the Rules contain lists of materials and products the manufacture of which shall be surveyed by the Register, as well as technological processes specified by the Register.

By special agreement, the Register may carry out the surveys of materials and products not mentioned in the above lists.

**2.2.2** Materials and products within the Register terms of reference shall be manufactured in accordance with technical documentation approved by the Register.

**2.2.3** During surveys, the Register may check compliance with structural, technological and production standards and processes which are not regulated by the Rules, but which may influence the fulfillment of the Rules requirements.

**2.2.4** During ship and FOP construction or repair, manufacture of materials and products, the Register shall approve the application of new materials, products and processes, or those submitted to it for the first time, that are within its terms of reference. For this purpose, specimens of the material, product or the new process shall be tested in the scope agreed with the Register subsequent to their technical documentation being approved by the Register.

**2.2.5** The Register surveys during the manufacture of materials and products are carried out by Surveyors to the Register, or may be entrusted by the Register to another classification body in accordance with Agreement on Mutual Substitution.

**2.2.6** In cases specified by the Register, the manufacturing works will be surveyed by the Register to inspect the facilities for manufacturing materials and products complying with the Register requirements.

**2.2.7** In the process of surveys during manufacture materials and products shall undergo the surveys and tests according to the procedures and within the scope prescribed by the Register.

**2.2.8** Materials and products manufactured in accordance with the Register requirements shall be provided with the documents specified by the Register and, where necessary, the brands and marking enabling to determine their compliance with the above documents.

**2.2.9** In sound cases, the Register may establish special conditions for the application of particular products.

### 2.3 SURVEYS OF SHIPS AND FOP UNDER CONSTRUCTION, RECONSTRUCTION AND CONVERSION

**2.3.1** Surveys of ships and FOP under construction, reconstruction and conversion are carried out by Surveyors to the Register on the basis of technical documentation approved by the Register. The scope of examinations, measurements and tests during surveys is determined by the Register on the basis of current instructions and proceeding from the situation.

## 2.4 SURVEYS OF SHIPS AND FOP IN SERVICE

**2.4.1** Surveys of ships and FOP in service is carried out according to Rules for the Classification Surveys of Ships in Service and other normative documents of the Register.

## 2.5 SURVEYS IN COMPLIANCE WITH THE REQUIREMENTS OF INTERNATIONAL CONVENTIONS AND AGREEMENTS

**2.5.1** The requirements of the following international conventions and agreements, as well as amendments thereto, are taken into account in the relevant Rules:

International Convention for the Safety of Life at Sea, 1974, Protocols, 1978, 1988 thereto;

International Convention for the Prevention of Pollution from Ships, 1973 and Protocol, 1978 thereto;

International Convention on Load Lines, 1966 and Protocol of 1988 Relating thereto (revised in 2003);

International Convention on Tonnage Measurement, 1969;

International Convention on Occupation Safety and Health (Dock Work), 1979 ( ILO 152 );

Shipping Regulations for the Danube, 1975;

Convention on Tonnage Measurement of Ships of Inland Navigation, 1966;

International Regulations for Preventing Collisions at Sea, 1972;

Final Acts of the World Administrative Radio Conference, 1997;

IMO Code for the Construction and Equipment of Ships Carrying Dangerous Chemicals in Bulk;

IMO Code for the Construction and Equipment of Ships Carrying Liquefied Gases in Bulk;

IMO Code of Safety for High-Speed Craft;

IMO Code for the Construction and Equipment of Mobile Offshore Drilling Units;

IMO Code of Safety for Special Purpose Ships;

IMO Code of Safety for Diving Systems;

inter-governmental agreements on load lines in force;

other normative documents used in international sea-going practice.

The provisions of the above conventions and agreements apply to ships engaged on international voyages.

**2.5.2** Surveys of items falling under the requirements of international conventions and agreements are carried out in conformity with approved technical documentation and the normative documents of the Register considering the requirements of the above conventions and agreements.



**RULES  
FOR THE EQUIPMENT  
OF SEA-GOING SHIPS**

# PART I. SURVEY REGULATIONS

---

## 1 GENERAL

### 1.1 APPLICATION

**1.1.1** The Rules for the Equipment of Sea-Going Ships<sup>1</sup> apply to:

**.1** passenger ships, tankers, ships, intended for carriage of dangerous cargoes, as well as tugs, irrespective of the power of main engines and gross tonnage;

**.2** all self-propelled ships not specified in 1.1.1.1, with the main engines power 55 kW and upwards;

**.3** all ships not specified in 1.1.1.1 and 1.1.1.2, of 80 gross tonnage and upwards, or with the propulsion equipment power 100 kW and upwards.

**1.1.2** The requirements of these Rules apply also to the following ship types to the extent specified in the relevant rules for the classification and construction of these ships:

**.1** nuclear ships and floating facilities (see Rules for the Classification and Construction of Nuclear Ships and Floating Facilities);

**.2** nuclear support ships (see Rules for the Classification and Construction of Nuclear Support Vessels);

**.3** gas carriers (see Rules for the Classification and Construction of Gas Carriers);

**.4** chemical tankers (see Rules for the Classification and Construction of Chemical Tankers);

**.5** mobile offshore drilling units and fixed offshore platforms (see Rules for the Classification, Construction and Equipment of Mobile Offshore Drilling Units and Fixed Offshore Platforms);

**.6** high-speed craft (see Rules for the Classification and Construction of High-Speed Craft);

**.7** type A WIG craft (see Rules for the Classification and Construction of Type A WIG Craft);

**.8** manned submersibles, ship's diving systems and passenger submersibles (see Rules for the Classification and Construction of Manned Submersibles, Ship's Diving Systems and Passenger Submersibles);

**.9** sea-going pleasure boats (see Rules for the Classification and Technical Supervision of Sea-Going Pleasure Boats);

**.10** small deep-sea fishing vessels (see Rules for the Classification and Construction of Small Sea Fishing Vessels).

**1.1.3** These Rules may also be applied to ships not listed in 1.1.1 and 1.1.2 if agreed upon with the Register.

**1.1.4** The present Part of the Rules applies both to ships under construction and to ships in service, when stipulated accordingly in the Rules.

### 1.2 DEFINITIONS AND EXPLANATIONS

**1.2.1** The definitions and explanations concerning the general terminology are given in 1.1, Part I, "Classification" of Rules for the Classification and Construction of Sea-Going Ships and in Section 1, Part I "General Regulations for Technical Supervision" of Rules for Technical Supervision during Construction of Ships and Manufacture of Materials and Products for Ships.

The following definitions of the areas of navigation have been adopted for the purpose of the present Part of the Rules:

unrestricted area of navigation;

restricted area of navigation **R1** — navigation in sea areas at seas with a wave height of 8,5 m with 3 per cent probability and with the ships proceeding not more than 200 miles<sup>2</sup> away from the place of refuge and with an allowable distance between the places of refuge not more than 400 miles;

restricted area of navigation **R2** — navigation in sea areas at seas with a wave height of 7,0 m with 3 per cent probability with ships proceeding from the place of refuge not more than 100 miles and with an allowable distance between the places of refuge not more than 200 miles;

restricted area of navigation **R2-RSN** — river-sea navigation at seas with a wave height of 6,0 m with 3 per cent probability with ships proceeding from the place of refuge:

in open seas up to 50 miles and with an allowable distance between the places of refuge not more than 100 miles,

in enclosed seas up to 100 miles and with an allowable distance between the places of refuge not more than 200 miles;

restricted area of navigation **R3-RSN** — river-sea navigation at seas with a wave height of 3,5 m with 3 per cent probability with due regard for particular restrictions on the area and conditions of navigation resulting from the wind and wave conditions of the basins with determination of a maximum allowable distance from the place of refuge which in no case should be more than 50 miles;

restricted area of navigation **R3** — harbour, roadstead and coastal navigation within limits established by the Register in each case;

**Berth-connected ship** — for berth-connected ships (with indication of siding place position and geographical service area according to Fig. 4.3.3.6, Part IV "Stability" of the Rules for the Classification and Construction of Sea-Going Ships).

---

<sup>1</sup> Hereinafter referred to as "the Rules".

<sup>2</sup>A nautical mile (1852 m).

Specific restrictions for operation of floating cranes (hoisting operation and navigation with possible carriage of cargo on deck and/or in hold) will be established by the Register in each case.

The following explanations have been adopted for the purpose of the present Part of the Rules:

**R u l e s** means the Rules for the Equipment of Sea-Going Ships consisting of the following Parts:

- I — Survey Regulations;
- II — Life-Saving Appliances;
- III — Signal Means;
- IV — Radio Equipment;
- V — Navigational Equipment.

## **2 SURVEYS OF EQUIPMENT OF SHIPS IN SERVICE**

### **2.1 GENERAL**

**2.1.1** Surveys of all the equipment of a ship, whenever practicable, shall be held simultaneously.

In general, surveys of the equipment shall be held concurrently with periodical classification surveys, as stated in Section 3, Part I "General Provisions" of Rules for the Classification Surveys of Ships in Service.

### **2.2 INITIAL SURVEY**

**2.2.1** The initial survey is held in order to ascertain that the equipment initially submitted to the Register can be allowed for service on board the ship.

The scope of the initial survey of equipment is determined by the Register on the basis of Table 2.3 with due regard to the provisions stated under 2.5 of General Regulations for the Classification and Other Activity.

### **2.3 PERIODICAL SURVEYS**

**2.3.1** The periodical surveys (annual and special) are held in order to ascertain that the equipment complies with the requirements of the Rules and additional requirements of the Register. The scope of periodical surveys and intervals between them are given in Table 2.3. The scope of individual inspections, measurements, tests, etc. is determined by a Surveyor to the Register depending upon the instructions in force and particular circumstances.

### **2.4 OCCASIONAL SURVEYS**

**2.4.1** The occasional surveys of ship's equipment are held in all other cases except initial and periodical

surveys. The scope of the surveys and procedure for them are determined by the Register depending on the purpose of the survey and on technical condition of the equipment.

**2.4.2** A survey after emergency is carried out in case the damage has been sustained by ship's equipment, arrangements or outfit enlisted in the RS Nomenclature.

The survey shall be held in a port where the ship is at the moment or in the first port she calls after the emergency.

This survey is held in order to reveal the damage, agree upon the scope of work required to eliminate the consequences of an emergency and to determine possibility and conditions of retaining validity of the relevant documents of the Register.

**2.4.3** The occasional surveys may be held at the request of the shipowner or the underwriter to the extent necessary to comply with their application or they may be initiated by the Register.

### **2.5 SURVEY OF EQUIPMENT OF THE SHIPS IN SERVICE WHICH ARE NOT REGISTERED BY THE REGISTER**

**2.5.1** The Register may establish the survey of ship in service which is not registered by the Register provided that this ship was submitted to the initial survey (see 2.2).

**2.5.2** When submitting the ship for survey of the equipment the technical documentation in the scope defined in 3.2 as well as the documents on the previous survey of the equipment shall be submitted.

If the shipowner is not able to submit some materials from the ones specified in 3.2 he shall ensure the receiving by the Register of all the necessary information for carrying out the initial survey.

Table 2.3

| Scope of periodical surveys |   | Survey of a ship   |                    |                    |                    |                    |
|-----------------------------|---|--------------------|--------------------|--------------------|--------------------|--------------------|
| Nos.                        | Item to be surveyed   | 1st<br>annual      | 2nd<br>annual      | 3rd<br>annual      | 4th<br>annual      | special            |
| <b>1</b>                    | <b>Life-saving arrangements and appliances</b>  |                    |                    |                    |                    |                    |
| 1.1                         | Launching appliances  | P <sup>1</sup>     | P <sup>1</sup>     | P <sup>1</sup>     | P <sup>1</sup>     | P <sup>1</sup>     |
| 1.2                         | Lifeboats and rescue boats  | OP <sup>1, 2</sup> | OP <sup>1, 2</sup> | OP <sup>1, 2</sup> | OP <sup>1, 2</sup> | OP <sup>1, 2</sup> |
| 1.3                         | Rigid liferafts and buoyant apparatus   | O <sup>1</sup>     | O <sup>1</sup>     | O <sup>1</sup>     | O <sup>1</sup>     | O <sup>1</sup>     |
| 1.4                         | Inflatable liferafts, marine evacuation systems, inflated rescue boats, hydrostatic release units. Inflatable lifejackets, immersion suits, anti-exposure suits and thermal protective aids | CE <sup>3</sup>    | CE <sup>3</sup>    | CE <sup>3</sup>    | CE <sup>3</sup>    | CE <sup>3</sup>    |
| 1.5                         | Lifebuoys and rigid lifejackets   | C                  | C                  | C                  | C                  | CE <sup>3</sup>    |
| 1.6                         | Line-throwing appliances  | C                  | C                  | C                  | C                  | C                  |
| 1.7                         | Posters or signs using symbols  | C                  | C                  | C                  | C                  | C                  |
| <b>2</b>                    | <b>Signal means</b>   |                    |                    |                    |                    |                    |
| 2.1                         | Navigation and flashing lights  | P                  | P                  | P                  | P                  | OP                 |
| 2.1.1                       | Spare parts for navigation and flashing lights  | —                  | —                  | —                  | —                  | C                  |
| 2.2                         | Sound signal means  | P                  | P                  | P                  | P                  | P                  |
| 2.3                         | Signal shapes and pyrotechnic means   | C                  | C                  | C                  | C                  | C                  |
| <b>3</b>                    | <b>Navigational equipment</b>   |                    |                    |                    |                    |                    |
| 3.1                         | Standard magnetic compass   | P                  | P                  | P                  | P                  | EP                 |
| 3.2                         | Spare magnetic compass  | P                  | C                  | P                  | C                  | P                  |
| 3.3                         | Gyrocompass   | P                  | P                  | P                  | P                  | P                  |
| 3.4                         | Ship's heading or track control system  | P                  | P                  | P                  | P                  | P                  |
| 3.5                         | Transmitting heading device (THD)   | P                  | P                  | P                  | P                  | P                  |
| 3.6                         | Electronic chart display and information system (ECDIS)   | P                  | P                  | P                  | P                  | P                  |
| 3.7                         | Back up arrangements for ECDIS  | P                  | P                  | P                  | P                  | P                  |
| 3.8                         | Receiver for a global navigation satellite system(s)/terrestrial radionavigation system   | P                  | P                  | P                  | P                  | P                  |
| 3.9                         | Radar   | P                  | P                  | P                  | P                  | P                  |
| 3.10                        | Electronic plotting aid (EPA)   | P                  | P                  | P                  | P                  | P                  |
| 3.11                        | Automatic tracking aid (ATA)  | P                  | P                  | P                  | P                  | P                  |
| 3.12                        | Automatic radar plotting aid (ARPA)   | P                  | P                  | P                  | P                  | P                  |
| 3.13                        | Automatic identification system (AIS)   | P                  | P                  | P                  | P                  | P                  |
| 3.14                        | Voyage data recorder (VDR)  | EC                 | EC                 | EC                 | EC                 | EC                 |
| 3.15                        | Speed and distance measuring device (through the water, over the ground in the forward and athwartship direction)   | P                  | C                  | P                  | C                  | OP                 |
| 3.16                        | Mechanical log  | C                  | C                  | C                  | C                  | C                  |
| 3.17                        | Echo sounder  | P                  | P                  | P                  | P                  | OP                 |
| 3.18                        | Sound reception system  | P                  | P                  | P                  | P                  | P                  |
| 3.19                        | Radar reflector   | P                  | C                  | P                  | C                  | P                  |
| 3.20                        | Radiobeacon station   | P                  | P                  | P                  | P                  | P                  |
| 3.21                        | Navigational devices and instruments  | C                  | C                  | C                  | C                  | C                  |
| 3.22                        | Spaces intended for installation of navigational equipment  | C                  | C                  | C                  | C                  | C                  |
| 3.23                        | Sources of electrical power   | P                  | P                  | P                  | P                  | OMP                |
| 3.24                        | Aerials   | P                  | P                  | P                  | P                  | OP                 |
| 3.25                        | Earthing  | C                  | C                  | C                  | C                  | C                  |
| 3.26                        | Spare parts, measuring instruments, tools and materials   | C                  | C                  | C                  | C                  | CE                 |
| <b>4</b>                    | <b>Radio equipment</b>  |                    |                    |                    |                    |                    |
| 4.1                         | Spaces where shipboard radio communication facilities are installed   | C                  | C                  | C                  | C                  | C                  |
| 4.2                         | Spaces where survival craft radio communication facilities are located  | C                  | C                  | C                  | C                  | C                  |
| 4.3                         | VHF radio installation:   |                    |                    |                    |                    |                    |
|                             | DSC encoder;  | P                  | P                  | P                  | P                  | OMP                |
|                             | DSC watch receiver;   | P                  | P                  | P                  | P                  | OMP                |
|                             | Radiotelephone station  | P                  | P                  | P                  | P                  | OMP                |
| 4.4                         | MF radio installation:  |                    |                    |                    |                    |                    |
|                             | DSC encoder;  | P                  | P                  | P                  | P                  | OMP                |
|                             | DSC watch receiver;   | P                  | P                  | P                  | P                  | OMP                |
|                             | Radiotelephone station  | MP                 | MP                 | MP                 | MP                 | OMP                |
| 4.5                         | MF/HF radio installation:   |                    |                    |                    |                    |                    |
|                             | .1 DSC encoder;   | P                  | P                  | P                  | P                  | OMP                |
|                             | .2 DSC watch receiver;  | P                  | P                  | P                  | P                  | OMP                |
|                             | .3 radio receiver for telephony and NBDP;   | P                  | P                  | P                  | P                  | OMP                |
|                             | .4 radio transmitter for telephony, DSC and NBDP;   | MP                 | MP                 | MP                 | MP                 | OMP                |

| Nos.   | Item to be surveyed   | Survey of a ship |            |            |            |         |
|--|---|------------------|------------|------------|------------|---------|
|  |   | 1st annual       | 2nd annual | 3rd annual | 4th annual | special |
|  | .5 improved fidelity printer;   | P                | P          | P          | P          | OP      |
|  | .6 terminal printer   | P                | P          | P          | P          | OP      |
| 4.6  | INMARSAT ship earth station   | P                | P          | P          | P          | OMP     |
| 4.7  | Automatic device for generating the radiotelephone alarms signals   | MP               | MP         | MP         | MP         | OMP     |
| 4.8  | NAVTEX service receiver   | P                | P          | P          | P          | OMP     |
| 4.9  | EGC receiver  | P                | P          | P          | P          | OMP     |
| 4.10   | HF direct-printing radiotelegraphy receiver for reception of marine safety information                    | P                | P          | P          | P          | OMP     |
| 4.11   | COSPAS-SARSAT satellite EPIRB   | EP               | EP         | EP         | EP         | EP      |
| 4.12   | INMARSAT satellite EPIRB  | EP               | EP         | EP         | EP         | EP      |
| 4.13   | VHF EPIRB   | EP               | EP         | EP         | EP         | EP      |
| 4.14   | Radar transponder (ship, survival craft)  | P                | P          | P          | P          | P       |
| 4.15   | Radiotelephone distress frequency watch receiver on 2182 kHz  | P                | P          | P          | P          | OMP     |
| 4.16   | Automatic radiotelephone alarm signal receiver on 2182 kHz  | P                | P          | P          | P          | OMP     |
| 4.17   | Two-way VHF radiotelephone apparatus <sup>4</sup>   | CP               | CP         | CP         | CP         | CP      |
| 4.18   | Stationary two-way VHF radiotelephone apparatus <sup>4</sup>  | CP               | CP         | CP         | CP         | OMP     |
| 4.19   | Equipment of command broadcast apparatus (including spaces, sources of energy, earthings and spare parts) | P                | P          | P          | P          | OMP     |
| 4.20   | Sources of electrical power:  |                  |            |            |            |         |
|  | .1 transformers;  | P                | P          | P          | P          | OMP     |
|  | .2 accumulator batteries;   | P                | P          | P          | P          | OMP     |
|  | .3 charging devices (including automatic ones);   | P                | P          | P          | P          | OMP     |
|  | .4 cabling;   | C                | C          | C          | C          | OM      |
|  | .5 switchboards and fittings;   | P                | P          | P          | P          | OP      |
|  | .6 protective equipment against radio interference  | C                | C          | C          | C          | O       |
| 4.21   | Aerials   | MP               | MP         | MP         | MP         | OMP     |
| 4.22   | Lead-in and interior wiring of aerials  | C                | C          | C          | C          | O       |
| 4.23   | Earthing  | C                | C          | C          | C          | OM      |
| 4.24   | Spare parts, portable measuring instrument  | C                | C          | C          | C          | CP      |
| <p>Symbols used:</p> <p>O — examination with provision of measures to enable the items involved to be made accessible for examination, to be opened up or dismantled, if necessary;</p> <p>C — external examination;</p> <p>M — measurement of wears, clearances, insulation resistance, etc;</p> <p>P — testing of machinery, equipment and arrangements under working conditions, external examination included;</p> <p>E — checking of documents and/or brands confirming carrying-out of obligatory periodical checking by an appropriate competent body.</p> <p><sup>1</sup> When determining the technical condition of life-saving appliances as related to strength and/or tightness, the proof load testing of the launching devices, hook releasing devices of the lifeboat, lifeboats and rescue boats or checking of tightness of the boats and their air boxes or compartments of the rigid liferafts and buoyant apparatus may be required at the discretion of a Surveyor. Such testing and checking are obligatory during special surveys of ship for lifeboats, rescue boats of rigid and combination of rigid and inflated construction, rigid liferafts and buoyant apparatus of 10 years old and over, for inflated rescue boats of 5 years old and for the launching devices and hook releasing devices of the lifeboat — not less than once every 5 years. Measurement of residual thicknesses of metal structures being part of the life-saving arrangements shall be made at the discretion of a Surveyor.</p> <p><sup>2</sup> Checking in operation of motor lifeboats and rescue boats (during special survey), their propelling gears, launching and recovery appliances, drainage arrangements, as well as drenching and compressed air systems of the lifeboats in oil tankers.</p> <p><sup>3</sup> Checking of documentation to confirm carrying-out of the periodical surveys and testing at the survival craft stations as well as at other specialized locations for surveying, testing and repairing the personal life-saving appliances.</p> <p><sup>4</sup> The two-way VHF radiotelephone apparatus shall be powered by a primary battery not intended for use in distress.</p> |   |                  |            |            |            |         |

### 3 TECHNICAL DOCUMENTATION OF SHIP'S EQUIPMENT

#### 3.1 GENERAL

**3.1.1** General provisions relating to the technical documentation of ships, materials and equipment shall be found in Part II "Technical Documentation" of Rules for Technical Supervision during Construction of Ships and Manufacture of Materials and Products for Ships.

#### 3.2 TECHNICAL DESIGN AND WORKING PLAN DOCUMENTATION ON EQUIPMENT OF SHIP UNDER CONSTRUCTION

##### 3.2.1 General.

Prior to the commencement of the construction of a ship whose equipment shall meet the requirements of the Rules, the documents listed under 3.2.2 to 3.2.6 shall be submitted to the Register for consideration. The documents submitted for consideration shall be delivered in triplicate.

##### 3.2.2 General documentation.

Specification for all the equipment covered by the Rules (no stamp of approval is needed).

"Radio Equipment" Section of the Specification shall contain the information on the marine areas of ship's navigation and on maintenance of radio equipment under the requirements of Global Maritime Distress and Safety System (GMDSS). No stamp of approval is needed.

##### 3.2.3 Documentation on life-saving appliances.

**3.2.3.1** In case of subsequent consideration of working documentation, the following shall be submitted:

**.1** combined general arrangement plan of life-saving arrangements and appliances and their launching devices, means of embarkation, muster and embarkation stations, means of illumination, means of protection from seas, means to prevent any entry of water into the survival craft during launching;

**.2** list of life-saving appliances and arrangements with the indication of specifications and information on their approval by the Register;

**.3** necessary calculations and data proving the compliance with the Rules.

**3.2.3.2** Without further approval of working documentation the documents specified in 3.2.3.1, and additionally, a programme of tests of installed life-saving arrangements and appliances shall be submitted.

##### 3.2.4 Documentation on signal means.

**3.2.4.1** In case of subsequent approval of working documentation, the following shall be submitted:

**.1** list of signal means with their principal characteristics;

**.2** general arrangement plan of navigation lights, flashing lights, as well as pyrotechnic signal means with indication of their principal location;

**.3** connection circuits of navigation lights, flashing lights, as well as of electric audible signal means.

**3.2.4.2** With subsequent approval of working documentation the documents mentioned under 3.2.4.1, and, additionally, a programme of tests of installed signal means shall be submitted.

##### 3.2.5 Documentation on radio equipment.

**3.2.5.1** In case of subsequent approval of working documentation, the following documentation shall be submitted:

**.1** diagram of connections of radio equipment and commutation of aerials;

**.2** arrangement plans (is two sections, at least) of radio equipment and sources of electrical power, as well as heating, ventilation, communication, signalling and lighting systems in all ship's spaces intended to accommodate radio equipment;

**.3** arrangement plans of aerials (plan and side view) indicating the spaces containing the radio equipment;

**.4** drawings and diagrams of radio equipment for lifeboats, if such are provided;

**.5** calculation of range of VHF radio installations and MF radio installations (no stamp of approval is needed);

**.6** diagram of command broadcasting apparatus;

**.7** calculation of the capacity of reserve source of electrical power (accumulators) for supplying the radio installations (no stamp of approval is needed);

**.8** information on approval of the radio equipment by the Register or other authorized body;

**.9** descriptions, circuit diagrams, drawings, photos and test records of radio equipment having no approval by the Register.

**3.2.5.2** Without further approval of working documentation the documents specified in 3.2.5.1 shall be submitted, and also:

**.1** wiring diagram of radio equipment and commutation of aerials with indication of types and cross-sectional areas of cables as well as protective means from radio interference;

**.2** programmes for mooring and sea trials of installed radio equipment (to be submitted for approval on the trial site). The extent and procedure of trials, methods of surveys and inspections shall comply with the requirements of 15.4 (taking into account 19.4.3), 18.2, 18.3, Part V "Technical Super-

vision during Construction of Ships" of the Rules for Technical Supervision during Construction of Ships and Manufacture of Materials and Products for Ships;

.3 list of spare parts.

### **3.2.6 Documentation on navigational equipment.**

**3.2.6.1** In case of subsequent approval of working documentation, the following shall be submitted:

.1 connection diagram of navigational equipment;

.2 drawings (two sections at least) showing the arrangement of navigational equipment and their sources of electrical power, as well as heating, ventilation, communication, signalling and lighting systems in spaces intended to accommodate navigational equipment;

.3 drawings (plan and side view) of aerial arrangement and of spaces intended for navigational equipment;

.4 for ships having a distinguishing mark **OMBO** in their class notation, the scope of technical documentation to be submitted is determined by the requirements of 1.3.7, Part V "Navigational Equipment" of the Rules;

.5 list of navigational equipment installed on board ship with specification of manufacturer, type, supplier and reference of approval of this equipment by the Register;

.6 descriptions, drawings and reports on previous tests of navigational equipment having no approval by the Register (installation of such equipment is subject to special consideration by the Register in each particular case);

.7 drawings of fields of vision from navigating bridge showing:

.7.1 the horizontal field of vision from the various workstations, including the arc of individual blind sectors forward of the beam (over an arc of 180° from side to side right ahead);

.7.2 the vertical field of vision over the bow from conning position and the workstation for navigation and manoeuvring, including the line of sight under the upper edge of the window from standing working position at the workstation;

.7.3 window arrangement, including inclination, dimensions, framing and height of lower and upper edge above bridge deck surface as well as the height of the deckhead;

.8 bridge layout drawings showing:

.8.1 the bridge layout, including the configuration and location of all bridge workstations, including workstations for additional bridge functions;

.8.2 configuration and dimensions of workstation consoles including console foundations as well as location of instruments and equipment in all workstation consoles.

**3.2.6.2** With no subsequent approval of working documentation the documents specified in 3.2.6.1 shall be submitted, and also:

.1 wiring diagram of navigational instruments with indication of types and cross-sectional areas of cables as well as protective means from radio interference;

.2 programmes for mooring and sea trials of installed navigational equipment (to be submitted for approval on the trial site). The extent and procedure of trials, methods of surveys and inspections shall comply with the requirements of 16.3, 18.2, 18.3, Part V "Technical Supervision during Construction of Ships" of the Rules for Technical Supervision during Construction of Ships and Manufacture of Materials and Products for Ships;

.3 list of spare parts.

### **3.3 TECHNICAL DOCUMENTATION FOR EQUIPMENT OF SHIP SUBJECT TO CONVERSION OR RECONSTRUCTION**

**3.3.1** Prior to the commencement of work on conversion or reconstruction of a ship, technical documentation concerning those items of equipment which are liable to conversion or reconstruction shall be submitted to the Register for consideration.

**3.3.2** In case new items of equipment shall be fitted on board ship in service, which shall meet the requirements of the Rules, and which differ substantially from those fitted initially, additional technical documentation shall be submitted to the Register for consideration in connection with these items of the equipment within a scope required for a ship under construction (see 3.2).

### **3.4 WORKING DOCUMENTATION ON EQUIPMENT OF SHIP UNDER CONSTRUCTION**

#### **3.4.1 General documentation.**

The programme of mooring tests and sea trials of shipboard equipment and the list of spare parts shall be submitted for consideration.

#### **3.4.2 Documentation on life-saving appliances:**

.1 arrangement plans of lifeboats, rescue boats, liferafts, marine evacuation systems and their launching appliances;

.2 drawings and calculations of launching appliances for lifeboats and liferafts;

.3 drawings and calculations of the arrangements for embarkation of persons into the liferafts on water;

.4 drawings of fastening of launching appliances for lifeboats and liferafts;

.5 drawings of fastening of the arrangements for embarkation into the liferafts on water;

.6 drawings of securing the lifeboats and liferafts in stowed-for-sea-position;

.7 drawings of securing the personal life-saving appliances;

.8 drawings of fastening of hydrostatic release units.

**3.4.3 Documentation on signal means:**

.1 drawings of signal masts and their rigging;

.2 drawings of positioning and securing of signal means.

**3.4.4 Documentation on radio equipment:**

.1 wiring diagram of radio equipment, with indication of types and cross-sectional areas of cables as well as protective means from radio interference;

.2 diagrams of power supply of radio equipment from ship's sources of electrical power and means of electric protection;

.3 cabling diagrams, including runs of cables through watertight gastight, fire decks and bulkheads;

.4 drawing of arrangement and fastening of radio equipment and sources of electrical power;

.5 drawing of fastening of aerials and constructions of aerial leads-in and their precaution guards;

.6 structural drawing of earthing devices.

**3.4.5 Documentation on navigational equipment:**

.1 wiring diagram of navigational instruments with indication of types and cross-sectional areas of cables, as well as protective means from radio interference;

.2 diagrams of power supply of navigational instruments from ship's sources of electrical power and means of electric protection;

.3 drawing of arrangement and fastening of navigational instruments and their sources of electrical power;

.4 cabling diagrams, including cable penetrations through watertight decks and bulkheads;

.5 structural drawing of earthing devices.



## PART II. LIFE-SAVING APPLIANCES

---

### 1 GENERAL

#### 1.1 APPLICATION

**1.1.1** The requirements of the present Part of the Rules apply to the ships constructed after 1 July 1998 whose equipment with life-saving appliances and arrangements is subject to survey by the Register as well as to the life-saving appliances and arrangements intended for installation aboard these ships.

**1.1.2** The ships constructed before 1 July 1998 shall comply with the requirements of regulations being in force prior to 1 July 1998.

**1.1.3** For ships constructed before 1 July 1998, when life-saving appliances or arrangements on such ships are replaced or such ships undergo repairs, alterations or modifications of a major character which involve replacement of, or any addition to, their existing life-saving appliances or arrangements, such life-saving appliances or arrangements, in so far as is reasonable and practicable, comply with the requirements of the present Part of the Rules. However, if a survival craft other than an inflatable liferaft is replaced without replacing its launching appliance, or vice versa, the survival craft or launching appliance may be of the same type as that replaced.

**1.1.4** The present Part of the Rules lays down the technical requirements which life-saving appliances and arrangements shall comply with and specifies the number of these appliances and arrangements and their location on board ships.

**1.1.5** Upon agreement with the Register individual ships or classes of ships which, in the course of their voyage, do not proceed more than 20 miles from the nearest land, may be exempted from some requirements of the present Part provided that the sheltered nature and conditions of the voyage are such that the application of such requirements rendered unreasonable or unnecessary.

#### 1.2 DEFINITIONS AND EXPLANATIONS

**1.2.1** Definitions and explanations relating to the general terminology of the Rules are given in Part I "Classification" of Rules for the Classification and Construction of Sea-Going Ships.

For the purpose of the present Part of the Rules the following definitions have been adopted.

**Recovery time** for a rescue boat is the time required to raise the boat to a position where persons on board can disembark to the deck of the ship. Recovery time includes the time required to make preparations for recovery on board the rescue boat such as passing and securing a painter, connecting the rescue boat to the launching appliance, and the time to raise the rescue boat. Recovery time does not include the time needed to lower the launching appliance into position to recover the rescue boat.

**Immersion suit** is a protective suit made of waterproof material intended for reducing the body heat-loss of a person wearing it in cold water.

**Rescue boat** is a special life-saving appliance to be carried aboard ships in a state of continuous readiness for immediate use and intended to rescue persons fallen into the water, persons from a ship in distress, as well as to marshal and tow liferafts in emergency conditions.

**Length of ship** is 96 per cent of the total length on a waterline at 85 per cent of the least moulded depth measured from the top of the keel, or the length from the fore-side of the stem to the axis of the rudder stock on the same waterline, if that is greater.

In ships designed with a rake of keel the waterline on which this is measured shall be parallel to the designed waterline.

**Certificated height of installation of free-fall lifeboat** is a distance measured from the lowest point of the lifeboat in its launching position to the water surface approved by the Register.

**Anti-exposure suit** is a protective suit designed for use by rescue boat crews and marine evacuation system parties.

**Survival craft** is a craft capable of sustaining the lives of persons in distress from the time of abandoning the ship.

**The final port of destination** is the last port of call in the scheduled voyage at which the ship commences its return voyage to the country in which the voyage began.

**Short international voyage** is an international voyage in the course of which a ship is not more than 200 miles from a port or place in which the passengers and crew could be placed in safety. The distance between the last port of call in the country in which the voyage begins and the final port of destination as well as the return voyage shall not exceed 600 miles.

**International voyage** is a voyage from a country to which the International Convention for the Safety of Life at Sea, 1974, applies to a port outside this country, or conversely.

**Marine evacuation system** is an appliance for the rapid transfer of persons from the embarkation deck of a ship to a floating survival craft.

**Lightest sea-going condition** is the loading condition with the ship on even keel, without cargo, with 10 per cent stores and fuel remaining and in the case of a passenger ship with the full number of passengers and crew and their luggage.

**Inflatable appliance** is an appliance which depends upon non-rigid, gas filled chambers for buoyancy and which is normally kept uninflated until ready for use.

**Inflated appliance** is an appliance which depends upon non-rigid, gas filled chambers for buoyancy and which is kept inflated and ready for use at all times.

**Detection** is the determination of the location of survivors and life-saving appliances.

**Positive stability** is the ability of a craft to return to its original position after the removal of a heeling moment.

**Embarkation ladder** is the ladder provided at survival craft embarkation stations to permit safe access to survival craft after their launching.

**Retro-reflective material** is a material which reflects in the opposite direction a beam of light directed on it.

**Fast rescue boat** is a rescue boat which is capable of manoeuvring for at least 4 h at a speed of at least 20 knots in calm water with a crew of 3 persons and at least 8 knots with a full complement of persons and equipment.

**Novel life-saving appliance or arrangement** is an appliance or arrangement which embodies new features not fully covered by the provisions of this Chapter but which provides an equal or higher standard of safety.

**Float-free launching** is that method of launching survival craft whereby the craft is automatically released from a sinking ship and is ready for use.

**Free-fall launching** is that method of launching survival craft whereby the craft with its complement of persons and equipment on board is released from a ship and allowed to fall into the water without any restraining apparatus.

**Launching crew** is the personnel remaining aboard a lifeboat to handle it during launching and recovering.

**Launching appliance** is the davits and other arrangements aboard ship intended for launch-

ing and recovery the lifeboats, rescue boats and liferafts.

**Moulded depth** is the vertical distance measured from the top of the keel to the top of the freeboard deck beam at side. In wood and composite ships this distance is measured from the lower edge of the keel rabbet. Where the form at the lower part of the midship section is of a hollow character, or where thick garboards are fitted, the depth is measured from the point where the line of the flat of the bottom continued inwards cuts the side of the keel.

In ships having rounded gunwales, the moulded depth shall be measured to the point of intersection of the moulded lines of the deck and side shell plating, the lines extending as though the gunwales were of angular design.

If the freeboard deck is stepped in the longitudinal direction and the raised part of the deck extends over the point at which the moulded depth shall be determined, the moulded depth shall be measured to a line of reference extending from the lower part of the deck along a line parallel with the raised part.

**Thermal protective aid** is a bag or suit made of waterproof material with low thermal conductivity intended for restoring the body core temperature of the person being immersed in cold water.

**Water entry angle** is the angle between the horizontal and the keel of a free-fall lifeboat when it first enters water after falling from the certificated height of installation.

**Launching ramp angle** is the angle between the horizontal and the launch rail of the lifeboat in its launching position with the ship on even keel.

**Free-fall acceleration** is the rate of change of velocity experienced by the occupants during launching of a free-fall lifeboat.

**Highly visible colour** is saturate orange or yellow colour.

**Effective clearing of the ship** is the ability of the free-fall lifeboat to move away from the ship after free-fall launching without using its engine.

### 1.3 SCOPE OF SURVEY

**1.3.1** General provisions for the procedure of survey of the life-saving appliances and arrangements, their manufacturing and service, as well as the requirements for the technical documentation to be submitted to the Register for consideration and provisions concerning documents issued by the Register for the life-saving appliances and arrangements are given in General Regulations for the

Classification and Other Activity and in Part I "Survey Regulations".

Except cases prescribed by 1.3.5 and 1.3.6 the life-saving appliances and arrangements required by the present Part shall be approved by the Register.

**1.3.2** Before giving approval to life-saving appliances and arrangements the Register shall ensure that such life-saving appliances and arrangements:

**.1** are tested in accordance with the provisions of IMO resolution MSC.81(70) "Revised Recommendation on Testing of Life-Saving Appliances" considering the amendments introduced by IMO Resolution MSC.226(82) to confirm that they comply with the requirements of the present Part; or

**.2** have successfully undergone, to the satisfaction of the Register, tests which are basically equivalent to the tests prescribed in 1.3.2.1.

**1.3.3** Before giving approval to novel life-saving appliances or arrangements the Register shall ensure that such appliances and arrangements:

**.1** provide safety standards at least equivalent to those required by the present Part;

**.2** have successfully undergone, to the satisfaction of the Register, evaluation and tests.

**1.3.4** Procedures adopted by the Register for approval shall also include the conditions whereby approval would continue to be valid or it would be withdrawn.

**1.3.5** Before accepting life-saving appliances and arrangements that have not been previously approved by the Register, the Register shall be satisfied that life-saving appliances and arrangements comply with the requirements of the present Part.

**1.3.6** Life-saving appliances required by the present Part for which detailed specifications are not included in this Part of the Rules shall be to the satisfaction of the Register.

**1.3.7 Production tests.**

The Register shall require life-saving appliances to be subjected to such production tests as are necessary to ensure that the life-saving appliances are manufactured to the same standards as the approved prototype.

**1.3.8** The technical documentation on life-saving appliances and arrangements to be submitted to the Register for approval shall be as follows.

**1.3.8.1** On lifeboats and rescue boats the following shall be submitted:

**.1** specification (hull, machinery and electrical equipment) including calculations of strength, stability, unsinkability, carrying capacity (the number of persons), volume of buoyancy, calculations of protective means and compressed air system, heel of equipment (no stamp of approval is needed);

**.2** lines drawing;

**.3** longitudinal and transverse sections with indication of arrangement of the air cases or compartments, their volume and material;

**.4** drawing of the launching and recovery appliance (arrangement, securing and strength calculations);

**.5** drawing of the steering gear;

**.6** general arrangement plan with indication of stowage of equipment and accommodation of persons;

**.7** diagram of protective foldable cover (canopy);

**.8** shell expansion for metal lifeboats;

**.9** sailing rig, if available;

**.10** drawings of the propulsion unit and the shafting including calculations drawings of driving engine, bed and protective casing, fuel tank as well as electric equipment circuit diagram and choice of accumulator batteries;

**.11** test programme;

**.12** drawing of survival craft towing arrangements (location, securing and strength calculation);

**.13** drawing showing safety belts fitted to boat;

**.14** drawings of air support and water spray systems.

**1.3.8.2** On rigid liferafts the following shall be submitted:

**.1** specification of the liferaft including the strength calculations of the liferaft, its towing and launching and recovery arrangements, volume of deck area and carrying capacity (number of persons), as well as draught; heel of equipment (no stamp of approval is needed);

**.2** general arrangement plan (construction of liferaft and main dimensions) with indication of stowage of equipment and accommodation of persons;

**.3** test programme.

**1.3.8.3** On inflatable liferafts the following shall be submitted:

**.1** specification of the liferaft including the strength calculations of the towing and launching and recovery arrangements, volume of buoyancy, deck area and carrying capacity (number of persons), as well as draught; heel of equipment (no stamp of approval is needed);

**.2** general arrangement plan (construction of lifeboat and main dimensions with indication of accommodation of persons, stowage of equipment, location of fittings and valves), container drawing;

**.3** arrangement diagram, drawings and calculations of pressure vessels, fittings and valves of automatic gas inflation system, electric lighting circuit;

**.4** test programme.

**1.3.8.4** On lifejackets and lifebuoys, immersion suits and thermal protective aids the following shall be submitted:

**.1** specification (no stamp of approval is needed);

**.2** drawing and calculation of pressure vessels, fittings and valves of automatic gas inflation system in the case of inflatable lifejackets and immersion suits;

.3 general view drawing (construction, material and equipment);

.4 test programme.

**1.3.8.5** On items of equipment of life-saving appliances the following shall be submitted:

.1 specification (no stamp of approval is needed);

.2 general view drawing (construction, material and equipment);

.3 test programme.

**1.3.8.6** On launching appliances the following shall be submitted:

.1 specification (no stamp of approval is needed);

.2 general view drawing (construction, material and equipment);

.3 strength calculation and diagrams of forces (no stamp of approval is needed);

.4 test programme.

**1.3.8.7** On boat winches and mechanical drives the following shall be submitted:

.1 specification (no stamp of approval is needed);

.2 general view drawing (construction, material and parts with dimensions);

.3 strength calculation (no stamp of approval is needed);

.4 test programme.

**1.3.9** The following items are subject to survey by the Register during manufacture:

.1 lifeboats and rescue boats;

.2 liferafts (inflatable and rigid);

.3 lifebuoys;

.4 lifejackets;

.5 immersion and anti-exposure suits;

.6 thermal protective aids;

.7 marine evacuation systems;

.8 launching appliance winches;

.9 engines of lifeboats and rescue boats;

.10 line-throwing appliances;

.11 means of rescue;

.12 self-igniting lights of lifebuoys;

.13 self-activating smoke signals of lifebuoys;

.14 lifeboat searchlights;

.15 launching appliances of lifeboats, liferafts and rescue boats;

.16 containers for inflatable liferafts;

.17 release mechanism of lifeboats, liferafts and rescue boats;

.18 hydrostatic release units;

.19 embarkation ladders;

.20 lights of lifeboats, liferafts and lifejackets;

.21 buoyant rescue quoits with buoyant line;

.22 parachute flares, hand flares and buoyant smoke signals;

.23 manual bailing pumps of lifeboats;

.24 food rations;

.25 watertight receptacles with fresh water;

.26 sea-activated power sources for lights of lifejackets, liferafts and for lifebuoy self-igniting lights;

.27 items of equipment and parts of life-saving appliances and arrangements required in 6.8.5 and 6.13.8. Survey by the Register consists only of consideration and approval of technical documentation.

**1.3.10** Equipment of ships with life-saving appliances and arrangements shall be effected under survey by the Register.

## 2 REQUIREMENTS FOR ALL TYPES OF SHIPS

### 2.1 COMMUNICATIONS

#### 2.1.1 Radio life-saving appliances.

**2.1.1.1** At least three two-way VHF radiotelephone apparatus shall be provided on every passenger ship and on every cargo ship of 500 gross tonnage and upwards. At least two two-way VHF radiotelephone apparatus shall be provided on every cargo ship of 300 gross tonnage and upwards but less than 500 gross tonnage and on every fishing vessel. Such apparatus shall comply with the requirements of Section 14, Part IV "Radio Equipment".

**2.1.1.2** At least one radar transponder shall be carried on each side of every passenger ship and of every cargo ship of 500 gross tonnage and upwards. At least one radar transponder shall be carried on every cargo ship of 300 gross tonnage and upwards

but less than 500 gross tonnage and on every fishing vessel.

The radar transponders shall be stowed in such locations that they can be rapidly placed in any survival craft other than the liferaft or liferafts required by 4.1.1.4. Alternatively one radar transponder may be stowed in each survival craft other than those required by 4.1.1.4.

On ships carrying at least two radar transponders and equipped with free-fall lifeboats one of the radar transponders shall be stowed in a free-fall lifeboat and the other located in the immediate vicinity of the navigating bridge so that it can be utilized on board and ready for transfer to any of the other survival craft.

**2.1.1.3** Every fishing vessel, cargo ship of under 300 gross tonnage, non-propelled ship with people on

board towed or pushed at sea, or intended for the prolonged anchorage outside the port water area and roads, as well as ships not engaged in international voyages shall be fitted with one radar transponder and two sets of two-way VHF radiotelephone apparatus.

Upon agreement with the Register the roadstead ships and harbour ships may be exempted from the requirements of 2.1.1.1 and 2.1.1.2.

#### **2.1.2 Distress flares.**

Not less than 12 rocket parachute flares, complying with the requirements of 6.7.1, shall be carried and be stowed on or near the navigating bridge.

#### **2.1.3 On-board communications and alarm systems.**

**2.1.3.1** Emergency means comprised of either fixed or portable equipment or both shall be provided for two-way communications between emergency control stations, muster and embarkation stations and strategic positions on board.

**2.1.3.2** A general emergency alarm system complying with the requirements of 6.22.1 shall be provided and shall be used for summoning passengers and crew to muster stations and to initiate the actions included in the muster heel. The system shall be supplemented by either a public address system complying with the requirements of 6.22.2 or other suitable means of communication. Entertainment sound systems shall automatically be turned off when the general emergency alarm system is activated.

**2.1.3.3** The general emergency alarm system shall be audible throughout all the accommodation and normal crew working spaces. On passenger ships, the system shall also be audible on all open decks.

**2.1.3.4** On ships fitted with a marine evacuation system communication between the embarkation station and the platform or the survival craft shall be ensured.

#### **2.1.4 Public address systems on passenger ships.**

**2.1.4.1** In addition to the requirements of 2.1.3.2, all passenger ships shall be fitted with a public address system. With respect to passenger ships constructed before 1 July 1997 the requirements of 2.1.4.2 and 2.1.4.4, subject to the provisions of 2.1.4.5, shall apply not later than the date of the first periodical survey after 1 July 1997.

**2.1.4.2** The public address system shall be clearly audible above the ambient noise in all spaces, prescribed by 6.22.2.1, and shall be provided with an override function controlled from one location on the navigation bridge and such other places on board as deemed necessary, so that all emergency messages will be broadcast if any loudspeaker in the spaces concerned has been switched off, its volume has been turned down or the public address system is used for other purposes.

**2.1.4.3** On passenger ships constructed on or after 1 July 1997:

**.1** the public address system shall have at least two loops of the low surface flame spread cable which shall be sufficiently separated throughout their length and have two separate and independent amplifiers; and

**.2** the public address system and its performance standards shall be approved by the Register;

**.3** all rooms and spaces of each main fire zone shall comply with the requirements 2.1.4.3.1.

**2.1.4.4** The public address system shall be connected to the emergency source of electrical power required by Part XI "Electrical Equipment" of Rules for the Classification and Construction of Sea-Going Ships.

**2.1.4.5** Ships constructed before 1 July 1997 which are already fitted with the public address system approved by the Register which complies substantially with those required by 2.1.4.2, 2.1.4.4 and 6.22.2.1 are not required to change their system.

## **2.2 PERSONAL LIFE-SAVING APPLIANCES**

### **2.2.1 Lifebuoys.**

**2.2.1.1** Lifebuoys complying with the requirements of 6.2.1:

**.1** shall be distributed in order to be readily available on both sides of the ship and as far as practicable on all open decks extending to the ship's side; at least one lifebuoy shall be placed in the vicinity of the stern;

**.2** shall be stowed in order to be capable of being rapidly cast loose and shall not be permanently secured in any way.

**2.2.1.2** At least one lifebuoy on each side of the ship shall be fitted with a buoyant lifeline complying with the requirements of 6.2.4 equal in length to not less than twice the height at which it is stowed above the waterline in the lightest seagoing condition, or 30 m, whichever is the greater.

**2.2.1.3** Not less than one half of the total number of lifebuoys shall be provided with self-igniting lights complying with the requirements of 6.2.2; not less than two of these shall also be provided with self-activating smoke signals complying with the requirements of 6.2.3 and be capable of quick release from the navigating bridge; lifebuoys with lights and those with lights and smoke signals shall be equally distributed on both sides of the ship and shall not be the lifebuoys provided with lifelines in compliance with the requirements of 2.2.1.2.

**2.2.1.4** Each lifebuoy shall be marked in block capitals of the Roman alphabet with the name and port of registry of the ship.

### **2.2.2 Lifejackets.**

**2.2.2.1** For every person on board the ship a lifejacket complying with the requirements of 6.3.1 and 6.3.2 shall be provided and, in addition:

**.1** a number of lifejackets suitable for children equal to at least 10 per cent of the number of passengers on board or more as may be required to provide one lifejacket for each child;

**.2** a sufficient number of lifejackets shall be provided for persons on watch as well as for use at remotely located survival craft stations.

The lifejackets carried for persons on watch should be stowed on the bridge, in the engine control room and at any other manned watch station.

**2.2.2.2** Lifejackets shall be so placed as to be readily accessible and their position shall be plainly indicated. Whether, due to the particular arrangement of the ship the lifejackets provided in compliance with the requirements of 2.2.2.1 may become inaccessible, alternative provisions shall be made to the satisfaction of the Register which may include an increase in the number of lifejackets to be carried on board.

**2.2.2.3** If the lifejackets are not distributed between all the persons on the ship the stowage in one place of more than 20 pieces is not permitted. Deviation from the compliance with this requirement in each particular case shall be a subject of special consideration by the Register.

**2.2.2.4** The lifejackets used in totally enclosed lifeboats, except free-fall lifeboats, shall not impede entry into the lifeboat or seating, including operation of the seat belts in the lifeboat.

**2.2.2.5** Lifejackets selected for free-fall lifeboats, and the manner in which they are carried or worn, shall not interfere with entry into the lifeboat, occupant safety or operation of the lifeboat.

### **2.2.3 Immersion suits and anti-exposure suits.**

**2.2.3.1** An immersion suit, complying with the requirements of paragraph 6.4 or an anti-exposure suit complying with paragraph 6.5, of an appropriate size, shall be provided for every person assigned to crew the rescue boat or assigned to the marine evacuation system party. If the ship is constantly engaged in warm climates where, in the opinion of the Register thermal protection is unnecessary, this protective clothing need not be carried.

**2.2.3.2** Immersion suits shall be stowed on the ship in accordance with the manufacturer's instructions. As far as practicable a special room shall be provided for drying and airing of wetted immersion suits as well as for minor repairing them in accordance with the manufacturer's instructions.

## **2.3 ARRANGEMENT OF SURVIVAL CRAFT**

**2.3.1** Lifeboats and liferafts for which approved launching appliances are required shall be stowed as close to accommodation and service spaces as possible.

**2.3.2** Muster stations shall be provided close to the embarkation stations. Each muster station shall have sufficient clear deck space to accommodate all persons assigned to muster at that station, but at least 0,35 m<sup>2</sup> per person.

**2.3.3** Muster and embarkation stations shall be readily accessible from accommodation and work areas.

**2.3.4** Muster and embarkation stations shall be adequately illuminated by lighting supplied from the emergency source of electrical power required by Sections 9 and 19, Part XI "Electrical Equipment" of Rules for the Classification and Construction of Sea-Going Ships.

For the liferafts required by 4.1.1.4 use may be made of portable illuminating facilities which shall be capable to illuminate the stowed position of the raft as well as the water surface in the area into which the raft is launched in order to comply with the requirement of 2.7.7. The portable illuminating facilities shall be provided with holders to enable them to be secured on both sides of the ship.

**2.3.5** Alleyways, stairways and exits giving access to the muster and embarkation stations shall be lighted. Such lighting shall be capable of being supplied by the emergency source of electrical power required by Sections 9 and 19, Part XI "Electrical Equipment" of Rules for the Classification and Construction of Sea-Going Ships. In addition to and as part of the markings required in 8.5.5, Part III "Equipment, Arrangements and Outfit" of Rules for the Classification and Construction of Sea-Going Ships, routes to muster stations shall be indicated with the muster station symbol, intended for that purpose, in accordance with the recommendations of Appendix 2.

**2.3.6** Davit-launched and free-fall launched survival craft muster and embarkation stations shall be so arranged as to enable stretcher cases to be placed in survival craft.

**2.3.7** An embarkation ladder complying with the requirements of 6.20.7 extending, in a single length, from the deck to the waterline in the lightest seagoing condition under all conditions of trim of up to 10° and a heel of up to 20° either way shall be provided at each embarkation station or at every two adjacent embarkation stations for survival craft launched

down the side of the ship. However, the Register may permit such ladders to be replaced by approved devices to afford access to the survival craft when waterborne, provided that there shall be at least one embarkation ladder on each side of the ship.

Other means of embarkation enabling descent to the water in a controlled manner may be permitted for the liferafts required by 4.1.1.4. Knotted rope is not allowed for these purposes.

Embarkation ladders may not be provided for cargo and passenger ships of less than 500 gross tonnage as well as for fishing ships of less than 45 m in length where the liferafts to be boarded from the deck located at height at least 2 m (less than 1,5 m for passenger ships) above the waterline in the lightest seagoing condition and on the ships where the liferafts are launched from the stern by the method of free-fall launching.

**2.3.8** Where necessary, means shall be provided for bringing the davit-launched survival craft against the ship's side and holding them alongside so that persons can be safely embarked.

**2.3.9** Launching stations shall be in such positions as to ensure safe launching of the survival craft having particular regard to clearance from the propeller and steeply overhanging portions of the hull and so that, as far as possible, survival craft, except survival craft specially designed for free-fall launching, can be launched down the straight side of the ship. If positioned forward, they shall be located abaft the collision bulkhead in a sheltered position and, in the respect it is necessary to give special consideration to the strength of the launching appliance.

## 2.4 STOWAGE OF SURVIVAL CRAFT

**2.4.1** Each survival craft shall be stowed:

**.1** so that the survival craft nor its stowage arrangements will interfere with the operation of any other survival craft or rescue boat at any other launching station;

**.2** for ships of 500 gross tonnage and upwards, as near the water surface as is safe and practicable and, in the case of a survival craft other than a liferaft intended for throw-overboard launching, in such a position that the survival craft in the embarkation position is not less than 2 m above the waterline with the ship in the fully loaded condition under unfavorable conditions of trim of up to 10° and heel up to 20° either way, or to the angle at which the ship's weather deck edge becomes submerged, whichever is less;

**.3** in a state of continuous readiness so that two crew members can carry out preparations for embarkation and launching in less than 5 min;

**.4** fully equipped as required by this Part;

**.5** as far as practicable, in a secure and sheltered position and protected from damage by fire and explosion.

In particular, survival craft on tankers, other than the liferafts required by 4.1.1.4, shall not be stowed on or above a cargo tank, slop tank, or other tank containing explosive or hazardous cargoes.

**2.4.2** Liferafts for lowering down the ship's side shall be stowed as far forward of the propeller as practicable. On cargo ships of 80 to 120 m in length each liferaft shall be so stowed that the after end of the liferaft is not less than its length forward of the propeller. On cargo ships of 120 m in length and upwards and passenger ships of 80 m in length and upwards, each liferaft shall be so stowed that the after end of the liferaft is not less than 1,5 times the length of the liferaft forward of the propeller. Where necessary, the ship shall be so arranged that liferafts, in their stowed positions, are protected from damage by heavy seas.

**2.4.3** Liferafts shall be stowed attached to launching appliances.

**2.4.4** Every liferaft shall be stowed with its painter permanently attached to the ship.

**2.4.5** Each liferaft or group of liferafts shall be stowed with a float-free arrangement complying with the requirements of 6.8.6 so that each floats free and, if inflatable, inflates automatically when the ship sinks.

**2.4.6** Liferafts shall be so stowed as to permit manual release of one raft or container at a time from their securing arrangements.

**2.4.7** Requirements of 2.4.4 and 2.4.5 do not apply to liferafts required by regulation 4.1.1.4.

**2.4.8** Davit-launched liferafts shall be stowed within reach of the lifting hooks, unless some means of transfer is provided which is not rendered inoperable within the limits of trim and heel prescribed in 2.4.1.2 or by ship motion or power failure.

**2.4.9** Liferafts intended for throw-overboard launching shall be so stowed as to be readily transferable for launching on either side of the ship unless liferafts, of the aggregate capacity required by 4.1.1 to be capable of being launched on either side, are stowed on each side of the ship.

**2.4.10** Posters or signs shall be provided on the survival craft or in the vicinity of them and their launching controls and shall:

**.1** illustrate the purpose of controls and the procedures for operating the appliance and give relevant instructions or warnings;

**.2** be easily seen under emergency lighting conditions;

**.3** use symbols in accordance with the recommendations of Appendix 2.

## 2.5 STOWAGE OF RESCUE BOATS

**2.5.1** Rescue boats shall be stowed:

**.1** in a state of continuous readiness for launching is not more than 5 min, and if the inflated type, in a fully inflated condition at all times;

**.2** in a position suitable for launching and recovery;

**.3** so that neither the rescue boat nor its stowage arrangements will interfere with the operation of any survival craft at any other launching station;

**.4** in compliance with the requirements of 2.4, if they are also lifeboats.

## 2.6 STOWAGE OF MARINE EVACUATION SYSTEMS

**2.6.1** It is not permitted to arrange any openings, be they permanent openings, recessed promenades or temporary openings such as shell doors, windows and ports, in the ship's side between the embarkation station of the marine evacuation system and the waterline in the lightest sea-going condition. Windows or side scuttles of the non-opening type may be allowed if complying with the requirements of 2.2.4.4, Part VI "Fire Protection" of Rules for the Classification and Construction of Sea-Going Ships.

**2.6.2** Marine evacuation systems shall be in such positions as to ensure safe launching having particular regard to clearance from the propeller and steeply overhanging positions of the hull and so that, as far as practicable, the system can be launched down the straight side of the ship.

**2.6.3** Each marine evacuation system shall be stowed so that neither the passage nor platform nor its stowage or operational arrangements will interfere with the operation of any other life-saving appliance at any other launching station.

**2.6.4** Where appropriate, the ship shall be so arranged that the marine evacuation systems in their stowed positions are protected from damage by heavy seas.

## 2.7 SURVIVAL CRAFT LAUNCHING AND RECOVERY ARRANGEMENTS

**2.7.1** Unless in the present Part of the Rules expressly provided otherwise, launching and embarkation appliances complying with the requirements of 6.20 shall be provided for all survival craft except liferafts which are:

**.1** boarded from a position on deck less than 4,5 m above the waterline in the lightest seagoing

condition and which have a mass of not more than 185 kg;

**.2** boarded from a position on deck less than 4,5 m above the waterline in the lightest seagoing condition and which are stowed for launching directly from the stowed position under unfavourable conditions of trim of up to 10° and heel of up to 20° either way;

**.3** carried in excess of the survival craft for 200 per cent of the total number of persons on board the ship and which have a mass of not more than 185 kg;

**.4** carried in excess of the survival craft for 200 per cent of the total number of persons on board the ship, are stowed for launching directly from the stowed position under unfavourable conditions of trim of up to 10° and heel of up to 20° either way;

**.5** provided for use in conjunction with a marine evacuation system, complying with the requirements of 6.20.8 and stowed for launching directly from the stowed position under unfavourable conditions of trim of up to 10° and heel of up to 20° either way.

**2.7.2** Each lifeboat shall be provided with an appliance which is capable of launching and recovering the lifeboat.

In addition there shall be provision for hanging-off (attaching) the lifeboat to free the release gear for maintenance.

**2.7.3** Launching and recovery appliances shall be such that the appliance operator on the ship is able to observe the survival craft at all times during launching and for lifeboats during recovery.

**2.7.4** Only one type of release mechanism shall be used for similar survival craft carried on board the ship.

**2.7.5** Preparation and handling of survival craft at any one launching station shall not interfere with the prompt preparation and handling of any other survival craft or rescue boat at any other launching station.

**2.7.6** Falls, where used, shall be long enough for the survival craft to reach the water with the ship in its lightest seagoing condition, under unfavourable conditions of trim of up to 10° and heel of up to 20° either way.

**2.7.7** During preparation and launching the survival craft, its launching appliance and the area of water into which it is to be launched shall be adequately illuminated by lighting supplied from the emergency source of electrical power required by Sections 9 and 19, Part XI "Electrical Equipment" of Rules for the Classification and Construction of Sea-Going Ships.

**2.7.8** Means shall be available to prevent any discharge of water onto survival craft during abandonment.

**2.7.9** If there is a danger of the survival craft being damaged by the ship's stabilizer wings, means



shall be available, powered by an emergency source of power, to bring the stabilizer wings inboard. In this case indicators of the position of the stabilizer wings operated by an emergency source of power shall be available on the navigating bridge.

**2.7.10** If the lifeboats complying with the requirements of 6.14 are installed on the ship, a davit span shall be provided, fitted with not less than two lifelines of sufficient length to reach the water with the ship in the lightest seagoing condition, under unfavourable conditions of trim up to 10° and heel not less than 20° either way. The breaking strength of lifelines, as a whole, shall be at least 17 kN. Their rated diameter is not less than 20 mm.

**2.7.11** Launching appliances shall be installed on the open parts of the deck so that the lifeboats and rescue boats are stowed 3° inside from a vertical line drawn through a point of intersection of the boat deck with the side of the ship. If the launching appliances are mounted under the deck located above, the compliance with this requirement is the subject of a special consideration by the Register.

**2.7.12** Sets of davits shall be so stowed that the distance between two davits was equal to that between the sling hooks of the lifeboat. Where this requirement cannot be complied with, a 3° deviation to either side from the vertical line in the longitudinal direction may be allowed on agreement with the Register.

**2.7.13** Lifeboat tackle falls shall be evenly wound on the winch drum. Where the falls run through fixed sheaves, a maximum deviation of the rope from the sheave central plane shall not exceed 8° for grooved drums and 4° for smooth drums.

## **2.8 RESCUE BOAT EMBARKATION, LAUNCHING AND RECOVERY ARRANGEMENTS**

**2.8.1** The rescue boat embarkation and launching arrangements shall be such that rescue boat can be boarded and launched in the shortest time.

**2.8.2** If the rescue boat is one of the ship's lifeboats, the embarkation arrangements and launching station shall comply with the requirements of 2.3.

**2.8.3** Launching arrangements shall comply with the requirements of 2.7. All rescue boats shall be capable of being launched, where necessary utilizing painters, with the ship making headway at speeds up to 5 knots in calm water.

**2.8.4** Rapid recovery of the rescue boat shall be possible when loaded with its full complement of persons and equipment. If the rescue boat is also a lifeboat, rapid recovery shall be possible when loaded with its full complement of equipment and a crew consisting of at least 6 persons.

## **2.9 LINE-THROWING APPLIANCES**

**2.9.1** All ships shall be equipped with line-throwing appliances having four projectiles and four lines each.

**2.9.2** The ships not engaged on international voyages of 25 m in length and above shall be equipped with line-throwing appliances having not less than two projectiles and two lines each.

**2.9.3** On agreement with the Register ships of less than 25 m in length not engaged in international voyages as well as the roadstead and harbour ships may be exempted from carriage of line-throwing appliances.

### 3 REQUIREMENTS FOR PASSENGER SHIPS

#### 3.1 SURVIVAL CRAFT AND RESCUE BOATS

##### 3.1.1 Survival craft.

**3.1.1.1** Passenger ships engaged in voyages which are, based on cruising range, not short international voyages shall carry:

**.1** lifeboats complying with the requirements of 6.13 or 6.14 on each side of such aggregate capacity as will accommodate not less than 50 per cent of the total number of persons on board. On agreement with the Register it may be permitted the substitution of lifeboats by liferafts of equivalent total capacity provided that there shall never be less than sufficient lifeboats on each side of the ship to accommodate at least 37,5 per cent of the total number of persons on board. The liferafts shall comply with the requirements of 6.9 or 6.10 and shall be served by launching appliances equally distributed on each side of the ship; and

**.2** in addition, liferafts complying with the requirements of 6.9 or 6.10 of such aggregate capacity as will accommodate at least 25 per cent of the total number of persons on board. These liferafts shall be served by at least one launching appliance on each side which may be those provided in compliance with the requirements of 3.1.1.1.1 or equivalent approved appliances capable of being used on both sides of the ship. However, stowage of these liferafts need not comply with the requirements of 2.4.8.

**3.1.1.2** Passenger ships engaged in short international voyages shall carry:

**.1** lifeboats complying with the requirements of 6.14 or 6.15 equally distributed, as far as practicable, on each side of the ship and of such aggregate capacity as will accommodate at least 30 per cent of the total number of persons on board and liferafts complying with requirements of 6.9 or 6.10 of such aggregate capacity that, together with the lifeboat capacity, the survival craft will accommodate the total number of persons on board. The liferafts shall be served by launching appliances equally distributed on each side of the ship; and

**.2** in addition, liferafts complying with the requirements of 6.9 or 6.10 of such aggregate capacity as will accommodate at least 25 per cent of the total number of persons on board. These liferafts shall be served by at least one launching appliance on each side which may be those provided in compliance with the requirements of 3.1.1.2.1 or equivalent approved appliances capable of being used on both sides of the ship. However, stowage of these liferafts need not comply with the requirements of 2.4.8.

**3.1.1.3** All survival craft required to provide for abandonment by the total number of persons on board shall be capable of being launched with their full complement of persons and equipment after all persons have been assembled, with lifejackets donned within a period of time not exceeding 30 min. from the time the abandon ship signal is given.

**3.1.1.4** In lieu of meeting the requirements of 3.1.1.1, 3.1.1.2 passenger ships of less than 500 gross tonnage where the total number of persons on board is less than 200, may comply with the following:

**.1** they shall carry on each side of the ship liferafts complying with the requirements of 6.9 or 6.10 of such aggregate capacity as will accommodate the total number of persons on board;

**.2** unless the liferafts required by 3.1.1.4.1 can be readily transferred for launching on either side of the ship, additional liferafts shall be provided so that the total capacity available on each side will accommodate 150 per cent of the total number of persons on board;

**.3** if the rescue boat required by 3.1.2.2 is also a lifeboat complying with the requirements of 6.14 or 6.15 its capacity may be included in the aggregate capacity required by 3.1.1.4.1, provided that the total capacity of survival craft available on each side of the ship is at least 150 per cent of the total number of persons on board;

**.4** in the event of any one survival craft being lost or rendered unserviceable, there shall be sufficient survival craft available for use on each side, including any which are stowed in a position providing for easy side-to-side transfer at a single open deck level, to accommodate the total number of persons on board.

**3.1.1.5** A marine evacuation system or systems complying with the requirements of 6.20.8 may be substituted for the equivalent capacity of liferafts and launching appliances required by paragraphs 3.1.1.1 and 3.1.1.2.

**3.1.1.6** Passenger ships of coastal navigation under 30 m in length (of 200 gross tonnage and below) engaged on voyages at a distance not more than 12 miles from the land shall carry liferafts of such aggregate capacity as will accommodate 100 per cent of the total number of persons on board.

##### 3.1.2 Rescue boats.

**3.1.2.1** Passenger ships of 500 gross tonnage and over shall carry at least one rescue boat complying with the requirements of 6.19 on each side of the ship.

**3.1.2.2** Passenger ships of less than 500 gross tonnage shall carry at least one rescue boat complying with the requirements of 6.19.

**3.1.2.3** A lifeboat may be accepted provided that it and its launching and recovery arrangements also comply with the requirements for a rescue boat.

**3.1.2.4** Passenger ships under 30 m in length may, on agreement with the Register, be exempted from the requirement to carry a rescue boat provided their dimensions and manoeuvrability, vicinity of search and rescue services and hydrometeorological conditions in the area of navigation do not dictate necessary fulfilment of this requirement.

### **3.1.3 Marshalling of liferafts.**

**3.1.3.1** The number of lifeboats and rescue boats that are carried on passenger ships shall be sufficient to ensure that in providing for abandonment by the total number of persons on board not more than six liferafts need be marshalled by each lifeboat or rescue boat.

**3.1.3.2** The number of lifeboats and rescue boats that are carried on passenger ships engaged in short international voyages shall be sufficient to ensure that in providing for abandonment by the total number of persons on board not more than nine liferafts need be marshalled by each lifeboat or rescue boat.

## **3.2 PERSONAL LIFE-SAVING APPLIANCES**

### **3.2.1 Lifebuoys.**

**3.2.1.1** A passenger ship shall carry not less than the prescribed number of lifebuoys complying with the requirements of 2.2 and 6.2.

| Length of ship, m           | Minimum number of lifebuoys |
|-----------------------------|-----------------------------|
| Under 60 . . . . .          | 8                           |
| 60 and under 120 . . . . .  | 12                          |
| 120 and under 180 . . . . . | 18                          |
| 180 and under 240 . . . . . | 24                          |
| 240 and over . . . . .      | 30                          |

**3.2.1.2** notwithstanding the requirements of 2.2.1.3, passenger ships under 60 m in length shall carry not less than six lifebuoys provided with self-igniting lights.

### **3.2.2 Lifejackets.**

**3.2.2.1** In addition to the lifejackets required by 2.2.2 every passenger ship shall carry lifejackets for not less than 5 per cent of the total number of persons on board. These lifejackets shall be stowed in conspicuous place on deck at muster stations.

**3.2.2.2** Where lifejackets for passengers are stowed in staterooms which are located remotely from direct routes between public spaces and muster stations, the additional lifejackets for these passengers required by 2.2.2.2, shall be stowed either in the

public spaces, the muster stations, or on direct routes between them. The lifejackets shall be stowed so that their distribution and donning does not impede orderly movement to muster stations and survival craft embarkation stations.

### **3.2.3 Lifejacket lights.**

On passenger ships each lifejacket shall be fitted with a light complying with the requirements of 6.3.3.

### **3.2.4 Immersion suits and thermal protective aids.**

**3.2.4.1** Passenger ships shall carry for each lifeboat on the ship at least three immersion suits complying with the requirements of 6.4 and, in addition, one thermal protective aid complying with the requirements of 6.6 for every person to be accommodated in the lifeboat and not provided with an immersion suit. These immersion suits and thermal protective aids need not be carried:

**.1** for persons to be accommodated in totally or partially enclosed lifeboats;

**.2** if the ship is constantly engaged in voyages in warm climates where, in the opinion of the Register, thermal protective aids are unnecessary.

**3.2.4.2** The provisions of 3.2.4.1 also apply to totally or partially enclosed lifeboats not complying with the requirements of 6.13 or 6.14, provided they are carried on ships constructed before 1 July 1986.

## **3.3 SURVIVAL CRAFT AND RESCUE BOAT EMBARKATION ARRANGEMENTS**

**3.3.1** On passenger ships, survival craft embarkation arrangements shall be designed for:

**.1** all lifeboats to be boarded and launched either directly from the stowed position or from an embarkation deck but not both;

**.2** davit-launched liferafts to be boarded and launched from a position immediately adjacent to the stowed position or from a position to which, in compliance with the requirements of 2.4.8, the liferaft is transferred prior to launching.

**3.3.2** Rescue boat embarkation arrangements shall be such that the rescue boat can be boarded and launched directly from the stowed position with the number of persons assigned to crew the rescue boat on board. Notwithstanding the requirements of 3.3.1 if the rescue boat is also a lifeboat and the other lifeboats are boarded and launched from an embarkation deck, the arrangements shall be such that the rescue boat can also be boarded and launched from the embarkation deck.

### **3.3.3 Stowage of survival craft.**

The stowage height of a survival craft on a passenger ship shall take into account the requirements of regulation 2.4.1.2, the escape provisions of Part III "Equipment, Arrangements and Outfit" of

Rules for the Classification and Construction of Sea-Going Ships, the size of the ship, and the weather conditions likely to be encountered in its intended area of operation. For a davit-launched survival craft, the height of the davit head with the survival craft in embarkation position, shall, as far as practicable, not exceed 15 m above the waterline when the ship is in its lightest sea-going condition.

#### **3.3.4 Muster stations.**

Every passenger ship shall comply with the requirements of 2.3 and, in addition, have passenger muster stations which shall:

**.1** be in the vicinity of, and permit ready access for the passengers to, the embarkation stations unless in the same location;

**.2** have ample room for marshalling and instruction of the passengers, but at least 0,35 m<sup>2</sup> per passenger.

### **3.4 ADDITIONAL REQUIREMENTS FOR RO-RO PASSENGER SHIPS**

**3.4.1** These requirements apply to all ro-ro passenger ships.

Ro-ro passenger ships constructed:

**.1** on or after 1 July 1998 shall comply with the requirements of 3.4.2.3, 3.4.2.4, 3.4.3.1 to 3.4.3.3, 3.4.4 and 3.4.5;

**.2** on or after 1 July 1986 but before 1 July 1998 shall comply with the requirements of 3.4.5 not later than the first periodical survey after 1 July 1998 and with the requirements of 3.4.2.3, 3.4.2.4, 3.4.3 and 3.4.4 not later than the first periodical survey after 1 July 2000;

**.3** before 1 July 1986 shall comply with the requirements of 3.4.5 not later than the first periodical survey after 1 July 1998 and with the requirements of 3.4.2.1 to 3.4.2.4, 3.4.3 and 3.4.4 not later than the first periodical survey after 1 July 2000;

**.4** before 1 July 2004 shall comply with the requirements of 3.4.2.5 not later than the first survey carried out on or after 1 July 2004.

#### **3.4.2 Liferafts.**

**3.4.2.1** The ro-ro passenger ships' liferafts shall be served by marine evacuation systems (MES) complying with the requirements of 6.20.8 or launching appliances equally distributed on each side of the ship complying with the requirements of 6.20.5.

**3.4.2.2** Every liferaft on ro-ro passenger ships shall be provided with float-free arrangements complying with the requirements of 6.8.6.

**3.4.2.3** Every liferaft on ro-ro passenger ships shall be fitted with a boarding ramp complying with the requirements of 6.9.4.1 or 6.10.4.1.

**3.4.2.4** Every liferaft on ro-ro passenger ships shall be either canopied reversible liferaft or self-

righting liferaft complying with the requirements of 6.11 and 6.12. Alternatively, the ship may carry self-righting or reversible liferafts, in addition to its normal complement of liferafts of such aggregate capacity as will accommodate at least 50 per cent of the persons not provided with seats in lifeboats. This additional liferaft capacity is determined on the basis of the difference between the total number of persons on board and the number of persons provided with seats in lifeboats.

**3.4.2.5** Liferafts carried on ro-ro passenger ships shall be fitted with a radar transponder in the ratio of one transponder for every four liferafts.

The transponder shall be mounted inside the liferaft so its antenna is more than one meter above the sea level when the liferaft is deployed, except that for canopied reversible liferafts the transponder shall be so arranged as to be readily accessed and erected by survivors.

Containers of liferafts fitted with transponders shall be clearly marked.

#### **3.4.3 Fast rescue boats.**

**3.4.3.1** At least one of the rescue boats on a ro-ro passenger ship shall be a fast rescue boat complying with the requirements of 6.19.4.

**3.4.3.2** Each fast rescue boat shall be served by a launching appliance complying with the requirements of 6.20.6. When approving these launching appliances, it shall be taken into account that the fast rescue boat is intended to be launched and recovered even under severe adverse weather conditions.

**3.4.3.3** At least two crews of each fast rescue boat shall be trained and drilled regularly, including all aspects of rescue, handling, manoeuvring, operating these craft in various conditions and righting them after capsizing.

**3.4.3.4** In the case where the arrangement or size of a ro-ro passenger ship, constructed before 1 July 1997, is such as to prevent the installation of the fast rescue boat required in 3.4.3.1, the fast rescue boat may be installed in place of an existing lifeboat which is accepted as a rescue boat or, in the case of the ship constructed prior to 1 July 1986, a boat for use in an emergency, provided that all of the following conditions are met:

**.1** the fast rescue boat installed is served by a launching appliance complying with 3.4.3.2;

**.2** the capacity of the lifeboat lost by the above substitution is compensated by the installation of liferafts capable of carrying at least an equal number of persons served by the lifeboat replaced;

**.3** the above liferafts are served by the existing launching appliances or MES.

#### **3.4.4 Means of rescue.**

**3.4.4.1** Each ro-ro passenger ship shall be equipped with efficient means of rescue complying with the requirements of 6.20.9.

**3.4.4.2** The means of transfer of survivors to the ship may be part of a MES, or part of a system intended for rescue purposes.

**3.4.4.3** If the slide of a MES is intended to provide the means of transfer of survivors to the deck of the ship, the slide shall be equipped with handlines or a ladder to aid in climbing up the slide.

#### **3.4.5 Lifejackets.**

Notwithstanding the requirements in 2.2.2 and 3.2.2, a sufficient number of lifejackets shall be

stowed in the vicinity of muster stations so that passengers do not have to return to their cabins to collect their lifejackets.

#### **3.4.6 Helicopter landing and pick-up areas.**

**3.4.6.1** All ro-ro passenger ships shall be provided with a helicopter pick-up area.

**3.4.6.2** Ro-ro passenger ships of 130 m in length and upwards, constructed on or after 1 July 1999, shall be provided with a helicopter landing area.

## **4 REQUIREMENTS FOR CARGO SHIPS**

### **4.1 SURVIVAL CRAFT AND RESCUE BOATS**

#### **4.1.1 Lifeboats and liferafts.**

##### **4.1.1.1** Cargo ships shall carry:

**.1** on each side of the ship one or more lifeboats complying with the requirements of 6.15 of such aggregate capacity as will accommodate the total number of persons on board;

**.2** in addition, one or more inflatable or rigid liferafts, complying with the requirements of 6.9 or 6.10, of a mass of less than 185 kg and stowed in a position providing for easy side-to-side transfer at a single open deck level, and of such aggregate capacity as will accommodate the total number of persons on board. If the liferaft or liferafts are not of a mass of less than 185 kg and stowed in a position providing for easy side-to-side transfer at a single open deck level, the total capacity available on each side shall be sufficient to accommodate the total number of persons on board.

**4.1.1.2** In lieu of meeting the requirements of 4.1.1.1, cargo ships may carry:

**.1** one or more lifeboats, complying with the requirements of 6.16 capable of being free-fall launched over the stern of the ship of such aggregate capacity as will accommodate the total number of persons on board;

**.2** in addition, on each side of the ship one or more liferafts complying with the requirements of 6.9 or 6.10 of such aggregate capacity as will accommodate the total number of persons on board. The liferafts on at least one side of the ship shall be served by launching appliances.

**4.1.1.3** In lieu of meeting the requirements of 4.1.1.1 or 4.1.1.2, cargo ships of less than 85 m in length other than oil tankers, chemical tankers and gas carriers may comply with the following:

**.1** they shall carry on each side of the ship one or more liferafts complying with the requirements of 6.9

or 6.10 of such aggregate capacity as will accommodate the total number of persons on board;

**.2** unless the liferafts required by 4.1.1.3.1 are of a mass of less than 185 kg and stowed in a position providing for easy side-to-side transfer at a single open deck level, additional liferafts shall be provided so that the total capacity available on each side will accommodate 150 per cent of the total number of persons on board;

**.3** if the rescue boat required by 4.1.2 is also a lifeboat complying with the requirements of 6.15, it may be included in the aggregate capacity required by 4.1.1.3.1, provided that the total capacity of lifeboats and liferafts available on each side is sufficient to accommodate at least 150 per cent of the total number of persons on board;

**.4** in the event of any one survival craft being lost or rendered unserviceable, there shall be sufficient survival craft available for use on each side, including any which are of a mass of less than 185 kg and stowed in a position providing for easy side-to-side transfer at a single open deck level, to accommodate the total number of persons on board.

**4.1.1.4** Cargo ships where the horizontal distance from the extreme end of the stem or stern of the ship to the nearest end of the closest survival craft is more than 100 m shall carry, in addition to the liferafts required by 4.1.1.1.2 and 4.1.1.2.2 a liferaft stowed as far forward or aft, or one as far forward and another as far aft, as is reasonable and practicable. Such liferaft or liferafts may be securely fastened so as to permit manual release and need not be of the type which can be launched from an approved launching device.

**4.1.1.5** All survival craft required to provide for abandonment by the total number of persons on board, with the exception of the survival craft referred to in 2.7.1.1, shall be launched with their full complement of persons and equipment within a period of 10 min. from the time the abandon ship signal is given.

**4.1.1.6** Chemical tankers and gas carriers emitting toxic vapours or gases shall carry, in lieu of lifeboats complying with the requirements of 6.15, lifeboats complying with the requirements of 6.17.

**4.1.1.7** Oil tankers, chemical tankers and gas carriers carrying cargoes having a flashpoint not exceeding 60 °C (closed cup test) shall carry, in lieu of lifeboats complying with the requirements of 6.15, lifeboats complying with the requirements of 6.18.

**4.1.1.8** Notwithstanding the requirements of 4.1.1.1, bulk carriers as defined in paragraph 1.1.1, Part I "Classification" of the Rules for the Classification and Construction of Sea-Going Ships shall comply with the requirements of 4.1.1.2.

**4.1.1.9** Ships mentioned in 4.1.1.6 and 4.1.1.7 of less than 85 m in length and not engaged in international voyages may carry only one lifeboat of such capacity as will accommodate 100 per cent of the persons on board, if the launching appliance is fitted providing the lifeboat launching from either side of the ship.

**4.1.1.10** Harbour, roadstead and coastal ships shall carry one or several liferafts of such aggregate capacity as will accommodate 100 per cent of the persons on board.

On agreement with the Register in summer in these ships the liferafts may be replaced by the lifebuoys for 100 per cent of the persons on board, in this case the lifebuoys required in 4.2.1.1 may be included.

#### **4.1.2 Rescue boats.**

Cargo ships shall carry at least one rescue boat complying with the requirements of 6.19. A lifeboat may be accepted as a rescue boat, provided that it and its launching and recovery arrangements also comply with the requirement for a rescue boat.

**4.1.3** Cargo ships under 500 gross tonnage, on agreement with the Register, may be exempted from the requirements of 4.1.2, provided their dimensions and manoeuvrability as well as area of navigation do not dictate necessary fulfilment of this requirement.

**4.1.4** In addition to their lifeboats, all cargo ships constructed before 1 July 1986 shall carry:

**.1** one or more liferafts capable of being launched on either side of the ship and of such aggregate capacity as will accommodate the total number of persons on board. The liferaft or liferafts shall be equipped with a lashing or an equivalent means of securing the liferaft which will automatically release it from a sinking ship;

**.2** where the horizontal distance from the extreme end of the stem or stern of the ship to the nearest end of the closest survival craft is more than 100 m, in addition to the liferafts required by 4.1.4.1 a liferaft stowed as far forward or aft, or one as far forward and another as far aft, as is reasonable and practicable. Notwithstanding the requirements of

4.1.4.1, such liferaft or liferafts may be securely fastened so as to permit manual release.

## **4.2 PERSONAL LIFE-SAVING APPLIANCES**

### **4.2.1 Lifebuoys.**

**4.2.1.1** Cargo ships shall carry not less than the prescribed number of lifebuoys complying with the requirements of 2.2.1 and 6.2.

| Length of ship, m           | Minimum number of lifebuoys |
|-----------------------------|-----------------------------|
| Under 30 . . . . .          | 4                           |
| 30 and under 100. . . . .   | 8                           |
| 100 and under 150 . . . . . | 10                          |
| 150 and under 200 . . . . . | 12                          |
| 200 and over . . . . .      | 14                          |

**4.2.1.2** Self-igniting lights for lifebuoys on tankers required by 2.2.1.3 shall be of an electric battery type.

**4.2.2 Lifejacket lights (this paragraph applies to all cargo ships).**

On cargo ships each lifejacket shall be fitted with a light complying with the requirements of 6.3.3.

### **4.2.3 Immersion suits.**

**4.2.3.1** The requirements of 4.2.3.2 to 4.2.3.5 are applicable to all cargo ships. However, with respect to the cargo ships constructed before 1 July 2006, requirements of 4.2.3.2 to 4.2.3.5 shall be fulfilled not later than the first prescribed survey of equipment and outfit (annual/periodical/for renewal of certificate) carried out on or after 1 July 2006.

**4.2.3.2** An immersion suit of the appropriate size complying with the requirements of Chapter 6.4 shall be provided for every person on board. However, for ships other than bulk carriers, as defined in 1.1.1, Part I "Classification" of the Rules for the Classification and Construction of Sea-Going Ships, these immersion suits need not be required if the ship is constantly engaged on voyages in warm climates where the immersion suits are unnecessary.

**4.2.3.3** If a ship has any watch or work stations, which are located remotely from the place or places where immersion suits are normally stowed including remotely located survival craft carried in accordance with 4.1.1.4, additional immersion suits of the appropriated size shall be provided at these locations for the number of persons normally on watch or working at those locations at any time.

**4.2.3.4** Immersion suits shall be so placed as to be readily accessible and their position shall be clearly indicated.

**4.2.3.5** The immersion suits required by this paragraph may be used to fulfil the requirement of 2.2.3.1.

**4.2.3.6** With reference to cargo ships of unrestricted and restricted area of navigation not covered by the Convention SOLAS-74, the requirements of 4.2.3.2 to 4.2.3.5 shall be carried out not later than the first nearest prescribed survey of the equipment and outfit (annual/periodical/renewal) conducted on or after 1 July 2007.

**4.2.3.7** Cargo ships of restricted area of navigation **R3** (harbour, roadstead and coastal navigation) not engaged in international voyages need not be provided with immersion suits.

**4.2.4** In the neighbourhood of the stowed position of the liferafts required by 4.1.1.4 at least two lifejackets and at least two immersion suits shall be provided. They shall be readily accessible and their position shall be plainly indicated.

#### **4.3 SURVIVAL CRAFT EMBARKATION AND LAUNCHING ARRANGEMENTS**

**4.3.1** Cargo ship survival craft embarkation arrangements shall be so designed that lifeboats can be boarded and launched directly from the stowed position and davit launched liferafts can be boarded and launched from a position immediately adjacent to the stowed position or from a position to which the liferaft is transferred prior to launching in compliance with the requirements of 2.4.8.

**4.3.2** On cargo ships of 20 000 gross tonnage and upwards, lifeboats shall be capable of being launched with the ship making headway at speeds up to 5 knots in calm water, utilizing painters, where necessary.

**4.3.3** On cargo ships, as defined in 4.1.1.3 where no launching appliances complying with 2.7.1 are provided for liferafts, the embarkation stations of liferafts shall be provided on each side with embarkation ladders meeting the requirements of 6.20.7.

## **5 REQUIREMENTS FOR OTHER TYPES OF SHIPS**

### **5.1 FISHING VESSELS**

#### **5.1.1 Lifeboats, liferafts and rescue boats.**

Fishing vessels shall carry:

**.1** lifeboats complying with the requirements of 6.14 or 6.15 on each side of such aggregate capacity as will accommodate 50 per cent of the total number of persons on board;

**.2** in addition, the liferafts complying with the requirements of 6.9 or 6.10 of such aggregate capacity as will accommodate the total number of persons on board.

**5.1.2** On agreement with the Register the fishing vessels under 85 m in length may carry only the liferafts of such a capacity on each side as will accommodate the total number of persons on board.

Unless these liferafts can be readily transferred for launching on either side of the vessel, additional liferafts shall be provided on each side of such a capacity as will accommodate 50 per cent of persons on board.

**5.1.3** On agreement with the Register the fishing vessels under 45 m in length and having regard to the features of voyages and weather conditions may carry one or several liferafts of such aggregate capacity as will accommodate the total number of persons on board the vessel.

#### **5.1.4 Rescue boats.**

**5.1.4.1** Fishing vessel shall carry one rescue boat complying with the requirements of 6.19. The lifeboat may be used as a rescue boat provided that it complies with the requirements for a rescue boat.

**5.1.4.2** Fishing vessels under 45 m in length may, on agreement with the Register, be exempted from the requirements of 5.1.4.1, provided that their dimensions and manoeuvrability, vicinity of search and rescue services and meteorological information systems as well as service area and weather conditions do not dictate necessary fulfilment of this requirement.

**5.1.5** Arrangement of survival craft and rescue boats shall comply with the requirements of 2.4 and 2.5.

**5.1.6** Fishing vessels shall be provided with personal life-saving appliances as required for cargo ships. However, as regards the availability of immersion suits on board the fishing vessels constructed before 1 October 2008, the requirements of 4.2.3.2 to 4.2.3.5 shall be complied with not later than the first next specified survey of the equipment and outfit (annual/periodical/renewal) carried out on or after 1 October 2008.

**5.1.7** Every fishing vessel shall be provided with:

**.1** at least two sets of VHF radio telephone apparatus;

**.2** radar transponder.

### **5.2 SPECIAL PURPOSE SHIPS**

**5.2.1** Ships carrying on board not more than 50 persons of special personnel shall be provided with survival craft as required for cargo ships.

**5.2.2** Ships carrying on board more than 50 persons of special personnel shall be provided with

survival craft as required for passenger ships engaged in voyages which are not subject by their distance to the definition «short international voyages» (see 1.2).

**5.2.3** Ships mentioned in 5.2.1 may be provided with survival craft similar to passenger ships, provided that they comply with the requirements of the Rules for the subdivision of ships carrying not more than 50 persons of special personnel.

**5.2.4** Sail training ships, irrespective of their gross tonnage, carrying more than 50 persons of special personnel (trainees), may be provided with survival craft in accordance with 3.1.1.5 and in this case an immersion suit shall be provided for every person on board the ship.

### 5.3 SPECIALIZED SHIPS

**5.3.1** Salvage ships, icebreakers, ships equipped with means of combating fire at the other objects, pilot ships, tugs, ships of dredging fleet and other ships shall be provided with life-saving appliances as required for cargo ships, and icebreakers are assigned descriptive notation “special purpose ship” added to the character of classification shall be provided with life-saving appliances as required for special purpose ships.

**5.3.2** Salvage ships and ships equipped with means of combating fire at the other objects are recommended to be supplied with additional life-saving appliances (fast rescue boats, appliances for rapid recovery of survivors on board from the water, appliances for transfer of survivors on board from the survival craft, etc.) which quantity and composition are defined by shipowner and approved by the Register.

**5.3.3** Oil recovery ships shall be provided with life-saving appliances as required for oil tankers.

### 5.4 BERTH-CONNECTED SHIPS

**5.4.1** Berth-connected ships under 30 m in length shall be provided with at least two lifebuoys on each deck, and berth-connected ships of more than 30 m in length — with at least four lifebuoys on each deck.

**5.4.2** Each lifebuoy shall be fitted with a buoyant lifeline in length equal to not less than twice the distance measured between the lifebuoy and the waterline or 30 m, whichever is greater.

**5.4.3** The list of life-saving appliance of the berth-connected ships which are intended to be operated not in the immediate vicinity of the shore is subject to special consideration by the Register in each case.

## 6 REQUIREMENTS FOR LIFE-SAVING APPLIANCES

### 6.1 GENERAL REQUIREMENTS FOR LIFE-SAVING APPLIANCES

**6.1.1** Unless expressly provided otherwise or unless, in the opinion of the Register having regard to the particular voyages on which the ship is constantly engaged, other requirements are appropriate, all life-saving appliances prescribed in this section shall comply with the following requirements:

**.1** be constructed of materials approved by the Register;

**.2** not be damaged in stowage throughout the air temperature range  $-30\text{ }^{\circ}\text{C}$  to  $+65\text{ }^{\circ}\text{C}$ ;

**.3** operate throughout the seawater temperature range  $-1\text{ }^{\circ}\text{C}$  to  $+30\text{ }^{\circ}\text{C}$ , if they are likely to be immersed in seawater;

**.4** where applicable, be rot-proof, corrosion-resistant and not be unduly affected by seawater, oil or fungal attack;

**.5** be resistant to prolonged exposure of sunlight, (be resistant to deterioration);

**.6** be of a highly visible colour on all parts where this will assist detection;

**.7** be fitted with retro-reflective material where it will assist in detection and in accordance with Appendix 1;

**.8** if they shall be used in a seaway, be capable of satisfactory operation in that environment;

**.9** be clearly marked with approval information including the Register which approved it, and any operational restrictions; and

**.10** where applicable, be provided with electrical short circuit protection to prevent damage or injury.

**6.1.2** The period of acceptability of life-saving appliances which are subject to deterioration with age shall be determined. Such life-saving appliances shall be marked with a means for determining their age or the date by which they must be replaced. Permanent marking with a date of expiry is the preferred method of establishing the period of acceptability. Batteries not marked with an expiration date may be used if they are replaced annually, or in the case of a secondary battery (accumulator), if the condition of the electrolyte can be readily checked. In case of pyrotechnic lifesaving appliances, the date of expiry shall be indelibly marked on the product.



**6.1.3** The materials used for manufacturing the life-saving appliances and arrangements shall comply with the requirements of Part XIII "Materials" and the welded structures shall be made in accordance with the requirements of Part XIV "Welding" of Rules for the Classification and Construction of Sea-Going Ships.

**6.1.4** Chains and ropes (wire, natural fibre and synthetic fibre) shall comply with the requirements of Part XIII "Materials" of Rules for the Classification and Construction of Sea-Going Ships, while blocks, shackles, swivels, screw stretchers and other removable components shall comply with the requirements of Rules for the Cargo Handling Gear of Sea-Going Ships.

**6.1.5** Winches for launching appliances shall meet the applicable requirements of 6.1, Part IX "Machinery" of Rules for the Classification and Construction of Sea-Going Ships, while their electric drives shall meet the requirements of 5.9, Part XI "Electrical Equipment" of Rules for the Classification and Construction of Sea-Going Ships.

## 6.2 LIFEBOUYS

**6.2.1** Lifebuoy shall comply with the following requirements:

**.1** its outer diameter shall be not more than 800 mm and its inner diameter shall be not less than 400 mm;

**.2** be constructed of inherently buoyant material; it shall not depend upon rushes, cork shavings or granulated cork, other loose granulated material or any air compartment which depends on inflation for buoyancy;

**.3** be capable of supporting not less than 14,5 kg of iron in fresh water for a period of 24 h;

**.4** have a mass of not less than 2,5 kg;

**.5** not sustain burning or continue melting after being totally enveloped in a fire for a period of 2 s;

**.6** be constructed to withstand a drop into the water from the height equal to the distance between the place of stowage and the waterline in the lightest sea-going condition or 30 m, whichever is the greater, without impairing either its operating capability or that of its attached components;

**.7** if the lifebuoy is intended to operate the quick-release arrangement provided for the self-activated smoke signals and self-igniting lights, have a mass sufficient to operate this arrangement;

**.8** be fitted with a grabline not less than 9,5 mm in diameter and not less than 4 times the outside diameter of the buoy body in length. The grabline shall be secured at four equidistant points around the circumference of the buoy to form four equal loops.

**6.2.2** Self-igniting lights shall comply with the following requirements:

**.1** be of such construction that cannot be extinguished by water;

**.2** be of white colour and capable of either burning continuously with a luminous intensity of not less than 2 cd in all directions of the upper hemisphere or flashing (discharge flashing) at a rate of not less than 50 flashes and not more than 70 flashes per min with at least the corresponding effective luminous intensity;

**.3** be provided with a source of power capable of meeting the requirement of 6.2.2.2 for a period of at least 2 h;

**.4** be capable of withstanding the drop test required by 6.2.1.6.

**6.2.3** Self-activating smoke signal shall comply with the following requirements:

**.1** emit smoke of a highly visible colour at a uniform rate for a period of at least 15 min when floating in calm water;

**.2** not ignite explosively or emit any flame during the entire smoke emission time;

**.3** not be swamped in a seaway;

**.4** continue to emit smoke when submerged in water for a period of at least 10 s;

**.5** be capable of withstanding the drop test required by 6.2.1.6.

**6.2.4** Buoyant lifelines for lifebuoys shall comply with the following requirements:

**.1** be non-kinking;

**.2** have a diameter of not less than 8 mm;

**.3** have a breaking strength of not less than 5 kN.

## 6.3 LIFEJACKETS

### 6.3.1 General requirements for lifejackets.

**6.3.1.1** A lifejacket shall not burn (smoulder) or melt after being totally enveloped in a fire for a period of 2 s.

**6.3.1.2** An adult lifejacket shall be so constructed that:

**.1** at least 75 per cent of persons, who are completely unfamiliar with the lifejacket, can correctly don it within a period of one min without assistance, guidance or prior demonstration;

**.2** after demonstration, all persons can correctly don it within a period of 1 min. without assistance;

**.3** it is clearly capable of being worn in only one way or, as far as is practicable, cannot be donned incorrectly;

**.4** it is comfortable to wear;

**.5** it allows the wearer to jump from a height of at least 4,5 m into the water without injury and without dislodging or damaging the lifejacket.

**6.3.1.3** An adult lifejacket shall have sufficient buoyancy and stability in calm fresh water to:

**.1** lift the mouth of an exhausted or unconscious person not less than 120 mm clear of the water with the body inclined backwards at an angle of not less than 20° from the vertical position; and

**.2** turn the body of an unconscious person in the water from any position to one where the mouth is clear of the water in not more than 5 s.

**6.3.1.4** An adult lifejacket shall allow the person wearing it to swim a short distance and to board a liferaft or lifeboat.

**6.3.1.5** A child lifejacket shall be constructed and perform the same as an adult lifejacket except as follows:

**.1** donning assistance is permitted for small children;

**.2** it shall only be required to lift the mouth of an exhausted or unconscious wearer clear of the water a distance appropriate to the size of the intended wearer;

**.3** assistance may be given to board a survival craft, but wearer mobility shall not be significantly reduced.

**6.3.1.6** In addition to the markings required by 6.1.1.9, a child lifejacket shall be marked with:

**.1** the height or weight range for which the lifejacket will meet the testing and evaluation criteria recommended by 1.3.2;

**.2** a "child" symbol as shown in the "child's lifejacket" symbol adopted by Appendix 2.

**6.3.1.7** A lifejacket shall have buoyancy which is not reduced by more than 5 per cent after 24 h submersion in fresh water.

**6.3.1.8** Each lifejacket shall be fitted with a whistle firmly secured by a cord.

### **6.3.2 Inflatable lifejackets.**

A lifejacket which depends on inflation for buoyancy shall have not less than two separate compartments and comply with the requirements of 6.3.1 and shall:

**.1** inflate automatically on immersion, be provided with a device to permit inflation by a single manual motion and be capable of being inflated by mouth;

**.2** comply with the requirements of 6.3.1.2, 6.3.1.3, 6.3.1.4 in the event of loss of buoyancy in any one compartment;

**.3** comply with the requirements of 6.3.1.7 after automatic inflation.

### **6.3.3 Lifejacket lights.**

**6.3.3.1** Each lifejacket light shall:

**.1** have a luminous intensity of not less than 0,75 cd in all directions of the upper hemisphere;

**.2** have a source of power capable of providing a luminous intensity of 0,75 cd for a period of at least 8 h;

**.3** be visible over as great a segment of the upper hemisphere as is practicable when attached to a lifejacket;

**.4** be of white colour.

**6.3.3.2** If the light referred to in paragraph 6.3.3.1 is a flashing light it shall, in addition:

**.1** be provided with a manually operated switch; and

**.2** flash at a rate of not less than 50 flashes and not more than 70 flashes per min with an effective luminous intensity of at least 0,75 cd.

## **6.4 IMMERSION SUITS**

### **6.4.1 General requirements for immersion suits.**

**6.4.1.1** The immersion suit shall be constructed with waterproof materials such that:

**.1** it can be unpacked and donned without assistance within 2 min, taking into account donning of any associated clothing, donning of a lifejacket if the immersion suit is to be worn in conjunction with a lifejacket, and inflation of orally inflatable chambers, if fitted;

**.2** it will not sustain burning or continue melting after being totally enveloped in a fire for a period of 2 s;

**.3** it will cover the whole body with the exception of the face. Hands shall also be covered unless permanently attached gloves are provided;

**.4** it is provided with arrangements to minimize or reduce free air in the legs of the suit;

**.5** following a jump from a height of not less than 4,5 m into the water there is no undue ingress of water into the suit.

**6.4.1.2** An immersion suit which also complies with the requirements of 6.3 may be classified as a lifejacket.

**6.4.1.3** An immersion suit shall permit the person wearing it, and also wearing a lifejacket if the immersion suit shall be worn in conjunction with a lifejacket, to:

**.1** climb up and down a vertical ladder of at least 5 m in length;

**.2** perform normal duties during abandonment;

**.3** jump from a height of not less than 4,5 m into the water without damaging or dislodging the immersion suit, or being injured;

**.4** swim a short distance through the water and board a survival craft.

**6.4.1.4** An immersion suit which has buoyancy and is designed to be worn without a lifejacket shall be fitted with a light complying with the requirements of 6.3.3 and the whistle prescribed by 6.3.1.8.

**6.4.1.5** If the immersion suit shall be worn in conjunction with a lifejacket, the lifejacket shall be worn over the immersion suit. A person wearing such

an immersion suit shall be able to don a lifejacket without assistance.

**6.4.2 Thermal performance requirements for immersion suits.**

**6.4.2.1** An immersion suit made of material which has no inherent insulation shall be:

**.1** marked with instructions that it shall be worn in conjunction with warm clothing;

**.2** so constructed that, when worn in conjunction with warm clothing, and with a lifejacket if the immersion suit shall be worn with a lifejacket, the immersion suit continues to provide sufficient thermal protection, following one jump by the wearer into the water from a height of 4,5 m, to ensure that when it is worn for a period of 1 h in calm circulating water at a temperature of 5 °C, the wearer's body core temperature does not fall more than 2 °C.

**6.4.2.2** An immersion suit made of material with inherent insulation, when worn either on its own or with a lifejacket, if the immersion suit is to be worn with a lifejacket shall provide the wearer with sufficient thermal insulation, following one jump by the wearer into the water from a height of 4,5 m, to ensure that when it is worn for a period of 6 h in calm circulating water at a temperature of range 0 to 2 °C, the wearer's body core temperature does not fall more than 2 °C.

**6.4.2.3** The immersion suit shall permit the person wearing it with hands covered to pick up a pencil and write after being immersed in water at 5 °C for a period of 1 h.

**6.4.3 Buoyancy requirements.**

A person wearing either an immersion suit or an immersion suit with a lifejacket, shall be able to turn in fresh water from a face-down to a face-up position in not more than 5 s.

**6.5 ANTI-EXPOSURE SUITS**

**6.5.1 General requirements for anti-exposure suits.**

**6.5.1.1** The anti-exposure suit shall be constructed with waterproof materials such that it:

**.1** provides inherent buoyancy of at least 70 N;

**.2** is made of material which reduces the risk of heat stress during rescue and evacuation operations;

**.3** covers the whole body with the exception of the head and hands and, where the Register so permits, feet, gloves and a hood shall be provided in such a manner as to remain available for use with the anti-exposure suits;

**.4** can be unpacked and donned without assistance within 2 min.;

**.5** does not sustain burning or continue melting after being totally enveloped in a fire for a period of 2 s;

**.6** is equipped with a pocket for a portable VHF telephone;

**.7** has a lateral field of vision of at least 120°.

**6.5.1.2** An anti-exposure suit which also complies with the requirements of 6.3 may be classified as a lifejacket.

**6.5.1.3** An anti-exposure suit shall permit the person wearing it, to:

**.1** climb up and down a vertical ladder of at least 5 m in length;

**.2** jump from a height of not less than 4,5 m into the water with feet first, without damaging or dislodging the suit, or being injured;

**.3** swim through the water at least 25 m and board a survival craft;

**.4** don a lifejacket without assistance;

**.5** perform all duties associated with abandonment, assist others and operate a rescue boat.

**6.5.1.4** An anti-exposure suit shall be fitted with a light complying with the requirements of 6.3.3 and the whistle prescribed by 6.3.1.8.

**6.5.2 Thermal performance requirements for anti-exposure suits.**

**6.5.2.1** An anti-exposure suit shall:

**.1** if made of material which has no inherent insulation, be marked with instructions that it shall be worn in conjunction with warm clothing; and

**.2** be so constructed, that when worn as marked, the suit continues to provide sufficient thermal protection following one jump into the water which totally submerges the wearer and shall ensure that when it is worn in calm circulating water at a temperature of 5 °C, the wearer's body core temperature does not fall at a rate of more than 1,5 °C per hour, after the first 0,5 h.

**6.5.3 Stability requirements.**

A person in fresh water wearing an anti-exposure suit complying with the requirements of this section shall be able to turn from a face-down to a face-up position in not more than 5 s and shall be stable face-up. The suit shall have no tendency to turn the wearer face-down in moderate sea condition.

**6.6 THERMAL PROTECTIVE AIDS**

**6.6.1** A thermal protective aid shall be made of waterproof material having a thermal conductance of not more than 7800 W/(m<sup>2</sup>·K) and shall be so constructed that, when used to enclose a person, it shall reduce both the convective and evaporative heat loss from the wearer's body.

**6.6.2** The thermal protective aid shall:

**.1** cover the whole body of persons of all sizes wearing a lifejacket with the exception of the face.

Hands shall also be covered unless permanently attached gloves are provided;

.2 be capable of being unpacked and easily donned without assistance in a survival craft;

.3 permit the wearer to remove it in the water in not more than 2 min., if it impairs ability to swim.

**6.6.3** The thermal protective aid shall function properly throughout an air temperature range  $-30\text{ }^{\circ}\text{C}$  to  $+20\text{ }^{\circ}\text{C}$ .

## 6.7 PYROTECHNIC SIGNAL MEANS

### 6.7.1 Rocket parachute flares.

**6.7.1.1** The rocket parachute flare shall:

.1 be contained in a water-resistant casing;

.2 have brief instructions or diagrams clearly illustrating the use of the rocket parachute flare printed on its casing;

.3 be so designed as not to cause discomfort to the person holding the casing when used in accordance with the manufacturer's operating instructions;

.4 have integral means of ignition.

**6.7.1.2** The rocket shall, when fired vertically, reach an altitude of not less than 300 m. At or near the top of its trajectory, the rocket shall eject a parachute flare, which shall:

.1 burn with a bright red colour;

.2 burn uniformly with an average luminous intensity of not less than 30 000 cd;

.3 have a burning period of not less than 40 s;

.4 have a rate of descent of not more than 5 m/s;

.5 not damage its parachute or attachments while burning.

### 6.7.2 Hand flares.

**6.7.2.1** The hand flare shall:

.1 have brief instructions or diagrams printed on its casing clearly illustrating the use of the hand flare;

.2 be contained in a water-resistant casing;

.3 have integral means of ignition;

.4 be so designed as not to cause discomfort to the person holding the casing and not endanger the survival craft by burning or glowing residues when used it in accordance with the manufacturer's operating instructions.

**6.7.2.2** The hand flare shall:

.1 burn with a bright red colour;

.2 burn uniformly with an average luminous intensity of not less than 15 000 cd;

.3 have a burning period of not less than 1 min;

.4 continue to burn after having been immersed for 10 s under 100 mm of water.

### 6.7.3 Buoyant smoke signals.

**6.7.3.1** The buoyant smoke signal shall:

.1 be contained in a water-resistant casing;

.2 not ignite explosively when used it in accordance with the manufacturer's operating instructions;

.3 have brief instructions or diagrams printed on its casing clearly illustrating the use of the buoyant smoke signal.

**6.7.3.2** The buoyant smoke signal shall:

.1 emit highly visible smoke at a uniform rate for a period of not less than 3 min when floating in calm water;

.2 not emit any flame during the entire smoke emission time;

.3 not be swamped in a seaway;

.4 continue to emit smoke when submerged in water for 10 s under 100 mm of water.

## 6.8 LIFERAFTS

### 6.8.1 General.

**6.8.1.1** Construction of a liferaft shall provide its using in all sea conditions for not less than 30 days afloat.

**6.8.1.2** The liferaft shall be so constructed that when it is dropped into the water from a height of 18 m, the liferaft and its equipments will operate satisfactorily.

If the liferaft is stowed at a height of more than 18 m above the waterline in the lightest sea-going condition, it shall be of a type which has been satisfactorily drop-tested from at least that height.

**6.8.1.3** The floating liferaft shall be capable of withstanding repeated jumps onto it from a height of at least 4,5 m above its floor both with and without the canopy erected.

**6.8.1.4** The liferaft and its fitting shall be so constructed as to enable it to be towed at a speed of 3 knots in calm water with its full complement of persons and equipment and with one of its sea anchors streamed.

**6.8.1.5** The liferaft shall have a canopy to protect the occupant from exposure which shall automatically set in place when the liferaft is being put into operating condition. The canopy shall comply with the following:

.1 provide protection of the under-canopy space against heat and cold by means of either two layers of material separated by an air gap or other equally efficient means. Measures shall be taken to prevent accumulation of water in the air gap;

.2 its interior surface shall be of a colour that does not irritate the occupants;

.3 each entrance shall be clearly indicated and be provided with efficient adjustable closing arrangements which can be easily and quickly opened by persons clothed in immersion suits from inside and outside, and

closed from inside, the liferaft so as to permit ventilation but exclude seawater, wind and cold.

Liferafts accommodating more than eight persons shall have at least two diametrically opposite entrances;

.4 admit sufficient air for the occupants at all times, even with the entrances closed;

.5 have at least one viewing port;

.6 have the means for collecting rain water;

.7 it shall be provided with means to mount a survival craft radar transponder at a height of at least 1 m above the sea;

.8 have sufficient headroom for sitting occupants under all parts of the canopy.

### **6.8.2 Minimum carrying capacity and mass of liferafts.**

**6.8.2.1** No liferaft shall be approved which has a carrying capacity of less than six persons calculated in accordance with the requirements of 6.9.3 or 6.10.3 as appropriate.

**6.8.2.2** Unless the liferaft shall be launched by an approved launching appliance complying with the requirements of 6.20.5 or is not intended for easy side-to-side transfer, the total mass of the liferaft, its container and its equipment shall not be more than 185 kg.

### **6.8.3 Liferaft fittings.**

**6.8.3.1** The liferaft shall be fitted with lifelines securely becketed around the inside and outside of the liferaft.

**6.8.3.2** The liferaft shall be fitted with an efficient painter of length equal to not less than 10 m plus the distance from the stowed position to the waterline in the lightest seagoing condition or 15 m whichever is the greater. The breaking strength of the painter system, including its means of attachment to the liferaft, except the weak link required by 6.8.6, shall be not less than 15,0 kN for liferafts permitted to accommodate more than 25 persons, not less than 10,0 kN for liferafts permitted to accommodate 9 to 25 persons and not less than 7,5 kN for any other liferaft.

**6.8.3.3** A manually controlled exterior light shall be fitted to the uppermost position of the liferaft canopy or structure. The light shall be white and be capable of operating continuously for at least 12 h with a luminous intensity of not less than 4,3 cd in all directions of the upper hemisphere. However, if the light is a flashing light it shall flash at a rate of not less than 50 flashes and not more than 70 flashes per min for the 12 h operating period with an equivalent effective luminous intensity. The lamp shall light automatically when the canopy is erected. Batteries shall be of a type that does not deteriorate due to dampness or humidity in the stowed liferaft.

**6.8.3.4** A manually controlled interior light shall be fitted inside the liferaft capable of continuous operation

for a period of at least 12 h. It shall light automatically when the canopy is erected and shall produce an arithmetic mean luminous intensity of not less than 0,5 cd when measured over the entire hemisphere to permit reading of survival and equipment instructions. Batteries shall be of a type that does not deteriorate due to dampness or humidity in the stowed liferaft.

### **6.8.4 Davit-launched liferafts.**

**6.8.4.1** Davit-launched liferaft shall comply with the following provisions:

.1 be capable of withstanding, when loaded with its full complement of persons and equipment, a lateral impact against the ship's side at an impact velocity of not less than 3,5 m/s and also a drop into the water from a height of not less than 3 m without damage that will affect its function;

.2 be provided with means for bringing it alongside the embarkation deck and holding the liferaft securely during embarkation of persons.

**6.8.4.2** Every passenger ship davit-launched liferaft shall be so constructed that it can be rapidly boarded by its full complement of persons.

**6.8.4.3** Every cargo ship davit-launched liferaft shall be so constructed that it can be boarded by its full complement of persons in not more than 3 min from the time the instruction to board is given.

### **6.8.5 Equipment.**

**6.8.5.1** The normal equipment of every liferaft shall consist of:

.1 one buoyant rescue quito, attached to not less than 30 m of buoyant line;

.2 one knife of the non-folding type having a buoyant handle attached by a lanyard and stowed in a pocket on the exterior of the canopy near the point at which the painter is attached to the liferaft.

The liferafts which are permitted to accommodate 13 persons or more shall be provided with a second knife which may be of folding type;

.3 one buoyant bailer for a liferaft which is permitted to accommodate not more than 12 persons and two buoyant bailers for a liferaft which is permitted to accommodate 13 persons and more;

.4 two sponges;

.5 two sea-anchors each with a shock resistant hawser and tripping line if fitted, one being spare and the other permanently attached to the liferaft in such a way that when the liferaft inflates or is waterborne it will cause the liferaft to lie oriented to the wind in the most stable manner. The strength of each sea-anchor and its hawser and tripping line if fitted shall be adequate in all sea conditions. The sea-anchors shall have means to prevent twisting of the line and shall be of a type which is unlikely to turn inside out between its shroud lines. The sea-anchor permanently attached to davit-launched liferafts and liferafts fitted on passenger ships shall be arranged for manual

deployment only. All other liferafts shall have the sea-anchor deployed automatically when the liferaft inflates;

**.6** two buoyant oars (paddles);  
**.7** three tin-openers and a pair of scissors. Safety knives containing special tin-opener blades are satisfactory for this requirement;

**.8** one first-aid outfit in a waterproof case capable of being closed tightly after use;

**.9** one signal whistle or other equivalent sound signal providing a sound pressure level of about 100 dB at a distance of 1 m;

**.10** four red rocket parachute flares complying with the requirements of 6.7.1;

**.11** six hand flares complying with the requirements of 6.7.2;

**.12** two buoyant smoke signals complying with the requirements of 6.7.3;

**.13** one waterproof electric torch suitable for Morse signalling together with one spare set of batteries and one spare bulb in a waterproof container;

**.14** one efficient radar reflector, unless a radar transponder is stowed in the liferaft;

**.15** one daylight signalling mirror (heliograph) with instructions on its use for signalling to ships and aircraft;

**.16** a table of the life-saving signals in a waterproof container or on a watertight material (one copy);

**.17** one set of fishing tackle;

**.18** a food ration consisting of not less than 10000 kJ (2400 kCal) for each person the liferaft is permitted to accommodate. These rations shall be palatable, edible throughout the marked life, and packed in a manner which can be readily divided and easily opened, taking into account immersion suit gloved hands.

The rations shall be packed in permanently sealed metal containers or vacuum packed in a flexible packaging material with a negligible vapour transmission rate ( $< 0,1 \text{ g/m}^2$  per 24 hours at  $23 \text{ }^\circ\text{C}/85 \text{ \%}$  relative humidity when tested to a standard acceptable to the Register). Flexible packaging material shall be further protected by outer packing if needed to prevent physical damage to the food ration or other items as result of sharp edges. The packaging shall be clearly marked with date of packing and date of expiry, the production lot number, the content in the package and instructions for use. The content of the food ration and its portions shall be acceptable to the Register;

**.19** 1,5 l of fresh water for each person the liferaft is permitted to accommodate, of which either 0,5 l per person may be replaced by a de-sailing apparatus capable of producing an equal amount of fresh water in

2 days or 1 l per person may be replaced by a manually powered reverse osmosis desalinators, as described in 6.13.7.7, capable of producing an equal amount of fresh water in 2 days. The water shall satisfy suitable international requirements for chemical and microbiological content, and shall be packed in sealed watertight containers that are of corrosion resistant material or are treated to be corrosion resistant. Flexible packaging materials, if used, shall have a negligible vapour transmission rate ( $< 0,1 \text{ g/m}^2$  at  $23 \text{ }^\circ\text{C}/85 \text{ \%}$  relative humidity when tested to a standard accepted to the Register), except that individually packaged portions within a larger container need not meet this vapour transmission requirement. Each water container shall have a method of spill proof reclosure, except for individually packaged portions of less than 125 ml. Each container shall be clearly marked with date of packing and date of expiry, the production lot number, the quantity of water in the container, and instructions for consumption. The containers shall be easy to open, taking into account immersion suit gloved hands. Water for emergency drinking complying with the international standard acceptable to the Register is acceptable in compliance with these requirements;

**.20** one rustproof graduated vessel for drinking water;

**.21** anti-seasickness medicine sufficient for at least 48 h and one seasickness bag for each person the liferaft is permitted to accommodate;

**.22** instructions on how to survive in the liferaft;

**.23** instructions for immediate action;

**.24** personal thermal protective aids complying with the requirements of 6.6 sufficient for at least 10 per cent of the number of persons the liferaft is permitted to accommodate but not less than two.

**6.8.5.2** The marking required in 6.9.6.3.5, 6.10.6.7 on liferafts equipped in accordance with 6.8.5.1 shall be "SOLAS B PACK" in block capitals of the Roman alphabet.

**6.8.5.3** For the passenger ships engaged on short international voyages or on such voyages which by cruising range may be rendered as the short international voyages of such duration that, in the opinion of the Register, not all the items specified in 6.8.5.1 are necessary, the Register may allow the liferafts carried on such ships to be provided with the equipment specified in 6.8.5.1.1 to 6.8.5.1.6 inclusive, 6.8.5.1.8, 6.8.5.1.9, 6.8.5.1.13 to 6.8.5.1.16 inclusive, 6.8.5.1.21 to 6.8.5.1.24 inclusive as well as one half of the equipment specified in 6.8.5.1.10 to 6.8.5.1.12 inclusive. The marking required in 6.9.6.3.5 and 6.10.6.7 on such liferafts shall be "SOLAS B PACK" in block capitals of the Roman alphabet.

**6.8.5.4** The liferafts for coastal ships not engaged on international voyages shall at least be fitted with the following equipment:

.1 the items of equipment specified in 6.8.5.1.1, 6.8.5.1.4, 6.8.5.1.6, 6.8.5.1.8, 6.8.5.1.9, 6.8.5.1.11, 6.8.5.1.13 and 6.8.5.1.22;

.2 one buoyant bailer and one sea anchor.

The marking required in 6.9.6.3.5 and 6.10.6.7 on such liferafts shall be "C PACK" in block capitals of the Roman alphabet.

**6.8.5.5** In general the items of equipment of the liferaft shall be stowed in a container which shall be secured inside the liferaft, if the container is not an integral part of the liferaft or permanently attached to it, and be capable of floating in water for at least 30 min. without damage to its contents.

**6.8.6 Float-free arrangements for liferafts.**

**6.8.6.1** The liferaft painter system shall provide a connection between the ship and the liferaft and shall be so arranged as to ensure that the liferaft when released and inflated (if the liferaft is inflatable) is not dragged under by the sinking ship.

**6.8.6.2** If the float-free arrangements use a weak link, it shall:

.1 not be broken by the force required to pull the painter from the liferaft container;

.2 be of sufficient strength to permit the inflation of the liferaft;

.3 break under a strain of  $2,2 \pm 0,4$  kN.

**6.8.6.3** Hydrostatic release unit.

If the float-free arrangements use a hydrostatic release unit, it shall:

.1 be constructed of compatible materials so as to prevent malfunction of the unit. Galvanizing or other forms of metallic coating on parts of the hydrostatic release unit not permitted;

.2 automatically release the liferaft from a ship at a depth of not more than 4 m;

.3 have drains to prevent the accumulation of water in the hydrostatic chamber when the unit is in its normal position;

.4 be so constructed as to prevent release the liferaft from a ship when seas wash over the unit;

.5 be permanently marked on its exterior with its type and serial number;

.6 be permanently marked on the unit or identification plate securely attached to the unit, with the date of manufacture, type and serial number and whether the unit is suitable for use with a liferaft with a capacity of more than 25 persons;

.7 be such that each part connected to the painter system has a strength of not less than that required for the painter;

.8 if disposable, in lieu of the requirement in 6.8.6.3.6 be marked with a means of determining its date of expiry.

**6.9 INFLATABLE LIFERAFTS**

**6.9.1** Inflatable liferafts shall comply with the requirements of 6.8 and, in addition, shall comply with the requirements of the present Chapter.

**6.9.2 Construction of inflatable liferafts.**

**6.9.2.1** The main buoyancy chambers shall be divided into not less than two separate compartments, each inflated through a non-return inflation valve on each compartment. The buoyancy chambers shall be so arranged that in the event of any one of the compartments being damaged or failing to inflate, the intact compartments shall be able to support afloat the number of persons, each having a mass of 75 kg, which the liferaft is permitted to accommodate, seated in their normal positions with positive freeboard over the liferaft's entire periphery.

**6.9.2.2** The floor of the liferaft shall be waterproof and shall be capable to provide sufficient insulation against cold either:

.1 by means of one or more compartments which can be inflated automatically or by the occupants and then can be deflated and reinflated by the occupants;

.2 by other equally efficient means not dependent on inflation.

**6.9.2.3** The liferaft shall be capable of being inflated by one person. The liferaft shall be inflated with a nontoxic gas. The inflation system, including any relief valves installed in compliance with 6.9.2.4 shall be acceptable to the Register. Inflation shall be completed within a period of 1 min at an ambient temperature of between 18 °C and 20 °C and within a period of 3 min at an ambient temperature of -30 °C. After inflation the liferaft shall maintain its form when loaded with its full complement of persons and equipment.

The pressure vessels used in an automatic gas inflation system shall be approved by the Register or other competent body.

**6.9.2.4** Each inflatable compartment shall withstand a pressure equal to 3 times the working pressure and shall be prevented from reaching a pressure exceeding twice the working pressure either by means of relief valves or by a limited gas supply. Means shall be provided for fitting the topping-up pump or bellows required by 6.9.9.1 so that the working pressure can be maintained.

**6.9.3 Carrying capacity of inflatable liferafts.**

The number of persons which a liferaft shall be permitted to accommodate shall be equal to the lesser of:

.1 the greatest whole number obtained by dividing by 0,096 the volume in cubic metres of the inflated main buoyancy chambers (which for this purpose shall include neither the arches nor the thwarts if fitted);

.2 the greatest whole number obtained by dividing by 0,372 the inner horizontal cross-sectional area of the liferaft in square metres (which for this purpose may include the thwart or thwarts, if fitted, measured to the innermost edge of the buoyancy tubes);

.3 the number of persons having an average mass of 75 kg, all wearing either immersion suits and lifejackets or, in the case of davit-launched liferafts, lifejackets, that can be seated with sufficient comfort and headroom without interfering with the operation of any of the liferaft's equipment.

#### **6.9.4 Access into inflatable liferafts.**

**6.9.4.1** At least one entrance shall be fitted with a boarding ramp, capable of supporting a person weighing 100 kg sitting or kneeling or not holding onto any other part of the liferaft, to enable persons to board the liferaft from the sea. The boarding ramp shall be so arranged as to prevent significant deflation of the liferaft if the raft is damaged. The rest remains as it stands. The boarding ramp shall be so arranged as to prevent significant deflation of the liferaft if the ramp is damaged. In the case of a davit-launched liferaft having more than one entrance, the boarding ramp shall be fitted at the entrance opposite the bowing lines and embarkation facilities.

**6.9.4.2** Entrances not provided with boarding ramps shall have boarding ladders, the lowest step of which shall be situated not less than 0,4 m below the liferaft's light waterline.

**6.9.4.3** There shall be means inside the liferaft to assist persons to pull themselves into the liferaft from the ladder.

#### **6.9.5 Stability of inflatable liferafts.**

**6.9.5.1** Every inflatable liferaft shall be so constructed that, when fully inflated and floating with the canopy uppermost, it is stable in a seaway.

**6.9.5.2** The stability of the liferaft when in the inverted position shall be such that it can be righted in a seaway and in calm water by one person.

**6.9.5.3** The stability of the liferaft when loaded with its full complement of persons and equipment shall be such that it can be towed at speeds of up to 3 knots in calm water.

**6.9.5.4** The liferaft shall be fitted with water pockets complying with the following requirements:

.1 the water pockets shall be of a highly visible colour;

.2 the design shall be such that the pockets fill to at least 60 per cent of their capacity within 25 s of deployment;

.3 the pockets shall have an aggregate capacity of at least 220 l for liferafts up to 10 persons;

.4 the pockets for liferafts certified to carry more than 10 persons shall have an aggregate capacity of not less than  $20 N$  l, where  $N$  = number of persons carried;

.5 the pockets shall be positioned symmetrically round the circumference of the liferaft. Means shall be provided to enable air to readily escape from underneath the liferaft.

#### **6.9.6 Containers for inflatable liferafts.**

**6.9.6.1** The liferaft shall be packed in a container complied with the following requirements:

.1 be so constructed as to withstand hard wear under any conditions of service encountered at sea;

.2 when packed with the liferaft and its equipment, be of sufficient inherent buoyancy to pull the painter and to operate the gas inflation mechanism shall the ship sink;

.3 be watertight as far as practicable, except for drain holes in the container bottom.

**6.9.6.2** The liferaft shall be packed in its container in such a way as to ensure that the waterborne liferaft inflates in an upright position on breaking free from its container.

**6.9.6.3** The container shall be marked with the following data:

.1 manufacturer's name or trade mark;

.2 serial number;

.3 name of approving authority and the number of persons it is permitted to carry;

.4 SOLAS (excluding the containers containing the liferafts equipped in accordance with 6.8.5.4);

.5 type of emergency pack enclosed;

.6 date when last serviced;

.7 length of painter;

.8 mass of the packed liferaft, if greater than 185 kg;

.9 maximum permitted height of stowage above waterline (depending on drop-test height and length of painter);

.10 launching instructions.

.11 type of the weak link system if any inside the liferaft container or indication of its absence.

#### **6.9.7 Marking on inflatable liferafts.**

**6.9.7.1** The liferaft shall be marked with the following:

.1 manufacturer's name or trade mark;

.2 serial number;

.3 date of manufacture (month and year);

.4 name of authority approved the liferaft;

.5 name and place of servicing station where it was last serviced;

.6 number of persons it is permitted to accommodate over each entrance in characters not less than 100 mm in height of a colour contrasting with that of the liferaft.

**6.9.7.2** Provision shall be made for marking each liferaft with the name and port of registry of the ship to which shall to be fitted, in such a form that the ship identification can be changed at any time without opening the container.



**6.9.8 Davit-launched inflatable liferafts.**

**6.9.8.1** In addition to complying with the above requirements, a liferaft intended for use with a launching appliance, when suspended from its lifting hook or bridle, shall withstand a load of:

**.1** 4 times the mass of its full complement of persons and equipment, at an ambient temperature and a stabilized liferaft temperature of  $20 \pm 3$  °C with all relief valves inoperative;

**.2** 1,1 times the mass of its full complement of persons and equipment at an ambient temperature and a stabilized liferaft temperature of  $-30$  °C with all relief valves operative.

**6.9.8.2** Rigid containers of the liferafts to be launched by a launching appliance shall be so secured that the container or parts of it are prevented from falling into the sea during and after inflation and launching of the contained liferaft.

**6.9.9 Additional equipment for inflatable liferafts.**

**6.9.9.1** In addition to the equipment required by 6.8.5, every inflatable liferaft shall be provided with:

**.1** one repair outfit for repairing punctures in buoyancy compartments;

**.2** one topping-up pump or bellows.

**6.9.9.2** The knives, the tin openers and scissors required by paragraph 6.8.5 shall be of safe type.

**6.10 RIGID LIFERAFTS**

**6.10.1** Rigid liferafts shall comply with the requirements of 6.8 and in addition shall comply with the requirements of the present Part.

**6.10.2 Construction of rigid liferafts.**

**6.10.2.1** The buoyancy of the liferaft shall be provided by approved inherently buoyant material placed as near as possible to the periphery of the liferaft. The buoyant material shall be low flame spread or be protected by a relevant coating.

**6.10.2.2** The floor of the liferaft shall prevent the ingress of water and shall effectively support the occupants out of the water and insulate them from cold.

**6.10.3 Carrying capacity of rigid liferafts.**

The number of persons which a liferaft shall be permitted to accommodate shall be equal to the lesser of:

**.1** the greatest whole number obtained by dividing by 0,096 the volume of the buoyant material;

**.2** the greatest whole number obtained by dividing by 0,372 the horizontal cross-sectional area of the floor of the liferaft measured in square metres;

**.3** the number of persons having an average mass of 75 kg, all wearing immersion suits and lifejackets, that can be seated with sufficient comfort and

headroom without interfering with the operation of any of the liferaft's equipment.

**6.10.4 Access into rigid liferafts.**

**6.10.4.1** At least one entrance shall be fitted with a boarding ramp, capable of supporting a person weighing 100 kg sitting or kneeling and not holding onto other part of the liferaft, to enable persons to board the liferaft from the sea. In the case of a davit-launched liferaft having more than one entrance, the boarding ramp shall be fitted at the entrance opposite to the bowing and embarkation facilities.

**6.10.4.2** Entrances not provided with a boarding ramp shall have a boarding ladder, the lowest step of which shall be situated not less than 0,4 m below the liferaft's light waterline.

**6.10.4.3** There shall be means inside the liferaft to assist persons to pull themselves into the liferaft from the ladder.

**6.10.5 Stability of rigid liferafts.**

**6.10.5.1** Unless the liferaft is capable of operating safely whichever way up it is floating, its strength and stability shall be such that it is either self-righting or can readily be righted to the operating condition in a seaway and in calm water by one person.

**6.10.5.2** The stability of a liferaft when loaded with its full complement of persons and equipment shall be such that it can be towed at speeds of up to 3 knots in calm water.

**6.10.6 Marking on rigid liferafts.**

The liferaft shall be marked with:

**.1** name and port of registry of the ship to which it belongs;

**.2** manufacturer's name or trade mark;

**.3** serial number;

**.4** name of approving authority;

**.5** number of persons it is permitted to accommodate over each entrance in characters not less than 100 mm in height of a colour contrasting with that of the liferaft;

**.6** "SOLAS" (excepting the liferaft equipped in accordance with 6.8.5.4);

**.7** type of emergency pack enclosed;

**.8** length of painter;

**.9** maximum permitted height of stowage above waterline depending on drop-test height;

**.10** launching instructions.

**6.10.7 Davit-launched rigid liferafts.**

In addition to the above requirements, a rigid liferaft intended for use with an approved launching appliance, when suspended from its lifting hook or bridle, shall withstand a load of 4 times the mass of its full complement of persons and equipment.

### 6.11 CANOPIED REVERSIBLE LIFERAFTS

**6.11.1** All canopied reversible liferafts shall comply with the requirements of 6.8.1, inflatable canopied reversible liferafts — requirements of 6.9, except 6.9.5.2 and 6.9.6.2, rigid canopied reversible liferafts shall comply with the requirements of 6.10 except 6.10.5.1 and the requirements of the present Chapter.

**6.11.2** The canopied reversible liferafts shall be fitted with self-draining arrangements. Liferafts shall be capable of being safely used at all times by untrained persons.

**6.11.3** The canopied reversible liferaft shall be capable of operating safely whichever way up it is floating. The liferaft shall have a canopy on both sides of the main body, if applicable, of the liferaft, which shall be set in place when the liferaft is launched and waterborne. Both canopies shall comply with the requirements of 6.8.1.5.5, 6.8.3.3 and 6.8.3.4.

**6.11.4** The equipment required under 6.8.5 shall be readily accessible whichever way up the canopied reversible liferaft is floating, either by use of an equipment container which is accessible from either side, or by duplication of equipment on each side of the liferaft.

**6.11.5** The fully equipped canopied reversible liferaft shall float in a stable upright position at all times, regardless of the conditions of loading.

**6.11.6** The canopied reversible liferaft do not need to be arranged for easy side-to-side transfer, and are therefore, not subject to the 185 kg mass limitation of 6.8.2.2.

**6.11.7** On ro-ro passenger ships operating on fixed routes in shallow water, the requirements that liferafts be arranged as to ensure that the liferafts are not dragged under the sinking ship, can be achieved by using a liferaft painter with a length of at least the maximum depth of water plus an additional 20 per cent.

### 6.12 SELF-RIGHTING LIFERAFTS

**6.12.1** All self-righting liferafts shall comply with the requirements of 6.8.1, inflatable self-righting liferafts — requirements of 6.9, except 6.9.5.2 and 6.9.6.2, rigid self-righting liferafts shall comply with the requirements of 6.10 except 6.10.5.1 and the requirements of the present Chapter.

**6.12.2** The fully equipped liferaft shall automatically turn from a capsized position to an upright position on the surface of the water, regardless of whether it inflates in the inverted position underwater or capsizes for any reason following inflation.

**6.12.3** The self-righting liferafts shall be fitted with self-draining arrangements. Liferafts shall be capable of being safely used at all times by untrained persons.

**6.12.4** The self-righting liferafts do not need to be arranged for easy side-to-side transfer, and are therefore, not subject to the 185 kg mass limitation of 6.8.2.2.

**6.12.5** On ro-ro passenger ships operating on fixed routes in shallow water, the requirement that liferafts be arranged as to ensure that the liferafts are not dragged under the sinking ship, can be achieved by using a liferaft painter with a length of at least the maximum depth of water plus an additional 20 per cent.

### 6.13 LIFEBOATS

#### 6.13.1 Construction of lifeboats.

**6.13.1.1** All lifeboats shall be properly constructed and shall be of such form and proportion that they have ample stability in a seaway and sufficient freeboard when loaded with their full complement of persons and equipment, and are capable of being safely launched under all conditions of trim up to 10° and list up to 20° either way. All lifeboats shall have rigid hulls and shall be capable of maintaining positive stability when in an upright position in calm water and loaded with their full complement of persons and equipment and holed in any location below the waterline, provided no loss of buoyancy material or other damages.

**6.13.1.2** All lifeboats shall be of sufficient strength to:

.1 enable them to be safely lowered into the water when loaded with their full complement of persons and equipment;

.2 be capable of being launched and towed when the ship is making headway at a speed of 5 knots in calm water.

**6.13.1.3** Hulls and rigid covers of the lifeboats shall be manufactured of fire-retardant or low flame-spread materials.

**6.13.1.4** Seating shall be provided on thwarts, benches or fixed chairs which are constructed so as to be capable of supporting:

.1 a static load equivalent to the number of persons each weighing 100 kg for which spaces are provided in compliance with the requirements of 6.13.2;

.2 a load of 100 kg in any single seat location when a lifeboat to be launched by falls is dropped into the water from a height of at least 3 m;

.3 a load of 100 kg in any single seat location when a free-fall lifeboat is launched from a height of at least 1,3 times its free-fall certification height.

**6.13.1.5** Except for free-fall lifeboats, each lifeboat to be launched by falls shall be of sufficient strength to withstand a load, without residual deflection on removal of that load:

**.1** in the case of boats with metal hulls, 1,25 times the total mass of the lifeboat when loaded with its full complement of persons and equipment;

**.2** in the case of other boats, twice the total mass of the lifeboat when loaded with its full complement of persons and equipment.

**6.13.1.6** Except for free-fall lifeboats, each lifeboat to be launched by falls shall be of sufficient strength to withstand, when loaded with its full complement of persons and equipment and with, where applicable, skates or fenders in position, a lateral impact against the ship's side at an impact velocity of at least 3,5 m/s and also a drop into the water from a height of at least 3 m.

**6.13.1.7** The vertical distance between the floor surface and the interior of the enclosure or canopy extending over 50 per cent of the floor area shall be:

**.1** not less than 1,3 m for lifeboats permitted to accommodate 9 persons or less;

**.2** not less than 1,7 m for lifeboats permitted to accommodate 24 persons or more;

**.3** not less than the distance as determined by linear interpolation between 1,3 m and 1,7 m for lifeboats permitted to accommodate from 9 to 24 persons.

**6.13.1.8** Each lifeboat shall be fitted with a Type Approval Certificate issued by the Register, containing the following items:

number of the Type Approval Certificate;

manufacturer's name and address;

lifeboat model;

material of hull construction, in such detail as to ensure that compatibility problems in repair shall not occur;

total mass of fully equipped and fully manned boats;

the measured towing force of the lifeboat;

statement of approval as to 6.14, 6.15, 6.16, 6.17 or 6.18.

Moreover, the Register shall provide a series-built lifeboat with a Certificate which, in addition to the above items, specifies:

lifeboat serial number;

month and year of manufacture;

number of persons the lifeboat is approved to carry;

information required under 6.1.1.9.

Each lifeboat shall be fitted with a permanently affixed approval plate with the Register brand containing at least the following items:

manufacturer's name and address;

lifeboat model or type and serial number;

month and year of manufacture;

number of persons the lifeboat is approved to carry; and

the approval information required under paragraph 6.1.1.9.

#### **6.13.2 Carrying capacity of lifeboats.**

**6.13.2.1** No lifeboat shall be approved to accommodate more than 150 persons.

**6.13.2.2** The number of persons which a lifeboat is permitted to accommodate shall be equal to the lesser of:

**.1** the number of persons having an average mass of 75 kg all wearing lifejackets, that can be seated in a normal position without interfering with the means of propulsion or the operation of any of the lifeboat's equipment;

**.2** the number of spaces that can be provided on the seating arrangements in accordance with Fig. 6.13.2.2. The shapes may be overlapped as shown in the figure, provided footrests are fitted and there is sufficient room for legs and the vertical separation between the upper and lower seat is not less than 350 mm.

**6.13.2.3** Each seating position shall be clearly indicated in the lifeboat.

#### **6.13.3 Access into lifeboats.**

**6.13.3.1** Every passenger ship lifeboat shall be so arranged that it can be boarded by its full complement of persons in not more than 10 min from the time the instruction to board is given. Rapid disembarkation shall also be possible.

**6.13.3.2** Every cargo ship lifeboat shall be so arranged that it can be boarded by its full complement of persons in not more than 3 min from the time the instruction to board is given. Rapid disembarkation shall also be possible.

**6.13.3.3** Lifeboats shall have a boarding ladder that can be used on either side of the lifeboat to enable persons in the water to board the lifeboat. The lowest step of the ladder shall be not less than 0,4 m below the lifeboat's light waterline.

**6.13.3.4** The lifeboat shall be so arranged that helpless people can be brought on board either from the sea or on stretchers.

**6.13.3.5** All surfaces of the lifeboat on which persons might walk shall have a non-skid finish.

#### **6.13.4 Lifeboat buoyancy.**

All lifeboats shall have inherent buoyancy or shall be fitted with inherently buoyant material which shall not be adversely affected by seawater, oil or oil products, sufficient to float the lifeboat with all its equipment on board when flooded and open to the sea. Additional inherently buoyant material, equal to 280 N of buoyant force per person shall be provided for the number of persons the lifeboat is permitted to accommodate. Buoyant material, unless in addition

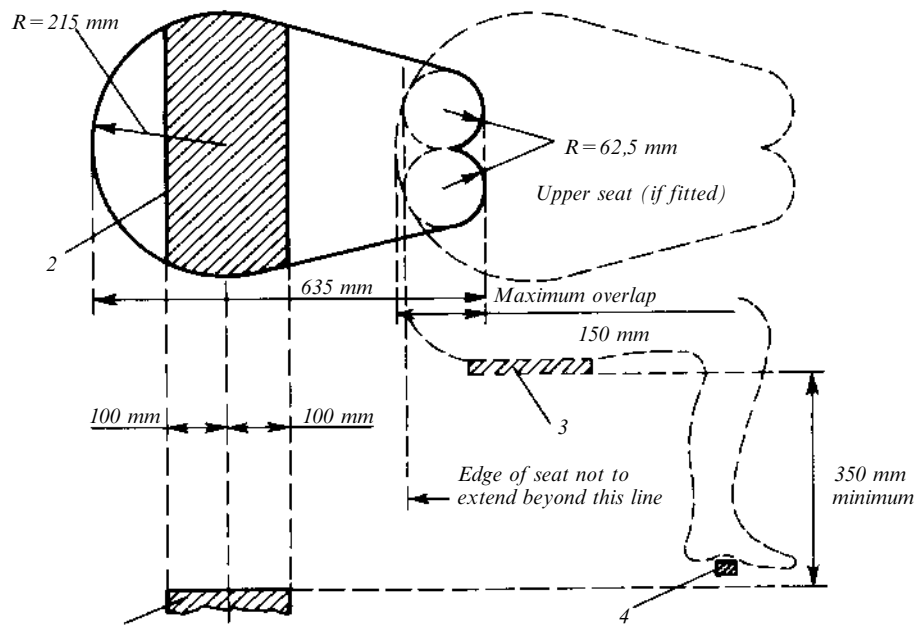

Fig. 6.13.2.2

to that required above, shall not be installed external to the hull of the lifeboat.

#### 6.13.5 Lifeboat freeboard and stability.

**6.13.5.1** All lifeboats shall be stable and have a positive GM value when loaded with 50 per cent of the number of persons the lifeboat is permitted to accommodate in their normal positions to one side of the centreline.

**6.13.5.2** Under the condition of loading in 6.13.5.1:

**.1** each lifeboat with side openings near the gunwale shall have a freeboard, measured from the waterline to the lowest opening through which the lifeboat may become flooded, of at least 1,5 per cent of the lifeboat's length or 100 mm, whichever is the greater;

**.2** each lifeboat without side openings near the gunwale shall not exceed an angle of heel of  $20^\circ$  and shall have a freeboard, measured from the waterline to the lowest opening through which the lifeboat may become flooded, of at least 1,5 per cent of the lifeboat's length or 100 mm, whichever is greater.

#### 6.13.6 Lifeboat propulsion.

**6.13.6.1** Every lifeboat shall be powered by a compression ignition engine. No engine shall be used for any lifeboat if its fuel has a flashpoint of  $43^\circ\text{C}$  or less (closed cup test).

**6.13.6.2** The engine shall be provided with either a manual starting system, or a power starting system with two independent sources of power. Any necessary starting aids shall also be provided. The engine starting systems and aids shall start the engine

at an ambient temperature of  $-15^\circ\text{C}$  within 2 min. of commencing the start procedure. The temperature at which safe starting of the engine shall be provided for the ships that are constantly engaged in particular voyages is subject to special consideration by the Register. The starting systems shall not be impeded by the engine casing, thwarts or other obstructions.

**6.13.6.3** The force on the handle when actuating the propelling gear at the moment of starting shall not be more than 160 N per one person.

**6.13.6.4** The engine shall be capable of operating for not less than 5 min. after starting from cold condition when the lifeboat is out of water in "ready-to-lower" condition.

**6.13.6.5** The engine shall be capable of operating when the lifeboat is flooded up to the centreline of the crank shaft.

**6.13.6.6** The engine shall be provided with a reverse-reduction gear or other arrangement disengaging the propeller shafting and the propeller from the engine. Provision shall be made for ahead and astern propulsion of the lifeboat.

**6.13.6.7** The exhaust pipe shall be so arranged as to prevent water from entering the engine in normal operation.

**6.13.6.8** The propeller shall be so arranged and guarded as to ensure safety of persons in the water and prevent damage to the propeller by floating debris.

**6.13.6.9** The speed of a lifeboat when proceeding ahead in calm water loaded with its full complement of persons and equipment and with all engine-

powered auxiliary equipment shall be at least 6 knots and at least 2 knots when towing a liferaft of maximum carrying capacity available on board loaded with its full complement of persons and equipment or its equivalent. Sufficient fuel shall be provided to run the fully loaded lifeboat at 6 knots for a period of not less than 24 h at a temperature range expected in the area in which the ship operates.

**6.13.6.10** The lifeboat engine, reverse-reduction gear and engine-suspended accessories shall be protected with a casing made of low spread flame materials or non-combustible materials in accordance with 1.6 of Part VI "Fire Protection" of Rules for the Classification and Construction of Sea-Going Ships, or by other suitable means providing similar protection.

Such means shall also protect persons from coming into accidental contact with hot or moving parts and protect engine from exposure to weather and sea. Adequate means shall be provided to reduce the engine noise so that a shouted order can be heard.

Starter batteries shall be placed into the watertight casings providing gas venting.

**6.13.6.11** The lifeboat engine and accessories shall be so constructed as to limit electromagnetic emission so that engine operation does not interfere with the operation of radio life-saving appliances used in the lifeboat.

**6.13.6.12** Means shall be provided for recharging all engine-starting, radio and searchlight batteries. Radio batteries shall not be used to provide power for engine starting and for searchlight operation. Means shall be provided for recharging lifeboat batteries from the ship's power supply at a supply voltage not exceeding 50 V which can be disconnected at the lifeboat embarkation station.

**6.13.6.13** Water-resistant instructions for starting and operating the engine shall be provided and mounted in conspicuous places near the engine starting controls.

**6.13.6.14** The beds for the engine and reverse-reduction gear shall be sufficiently strong and resistant to vibration, and the scantlings of their members shall be assigned with due regard to the power of the engine.

**6.13.6.15** The fuel and lubrication piping shall be effectively protected from mechanical damage and fitted with a readily accessible stop valve provided directly at the tank. The system of air supply and discharging the exhaust gases shall be so designed as to prevent water from penetrating into the engine and the exhaust pipe shall be efficiently insulated.

#### **6.13.7 Lifeboat fittings.**

**6.13.7.1** All lifeboats except free-fall lifeboats shall be provided with at least one drain valve fitted near the lowest point in the hull, which shall

automatically open to drain water from the hull when the lifeboat is not waterborne and shall automatically close to prevent entry of water when the lifeboat is waterborne. Each drain valve shall be provided with a cap or plug to close the valve, which shall be attached to the lifeboat by a lanyard, a chain, or other suitable means.

**6.13.7.2** A lifeboat shall be provided with a rudder and tiller.

When a wheel or other remote steering mechanism is also provided the tiller shall be capable of controlling the ship in case of failure of the steering mechanism.

The tiller shall be permanently installed on, or linked to, the rudder stock; however, if the lifeboat is provided with a remote steering mechanism, the tiller may be removable and securely stowed near the rudder stock. The rudder and tiller shall be arranged in order not to be damaged by operation of the launching and recovering appliance or by the propeller.

**6.13.7.3** Except in the vicinity of the rudder and propeller, suitable handholds shall be provided or a buoyant lifeline shall be becketed around the outside of the lifeboat above the waterline and within reach of a person in the water.

**6.13.7.4** A lifeboat which is not self-righting shall have such means as bilge keels or keel handholds to enable persons to cling to the capsized lifeboat. They shall be fastened to the lifeboat in such a way that, when subjected to heavy impact, they break away without damaging the hull of the lifeboat.

**6.13.7.5** All lifeboats shall be fitted with sufficient watertight lockers or compartments to provide for the storage of the small items of equipment, water and provisions required by 6.13.8. The lifeboat shall be equipped with a means for storing the collected rain water.

All lifeboats shall be equipped with a means for collecting rain water or for producing drinking water from seawater with a manually powered desalinator. The desalinator shall not be dependent upon solar heat, nor on chemicals other than seawater.

**6.13.7.6** Every lifeboat to be launched by a fall or falls, except a free-fall lifeboat, shall be fitted with release mechanism complying with the following requirements subject to sub-paragraph 6.13.7.6.9 below:

.1 the mechanism shall be so arranged that all hooks are released simultaneously;

.2 the mechanism shall have two release capabilities: normal (off-load) release capability and on-load release capability:

.2.1 normal (off-load) release capability shall release the lifeboat when it is waterborne or when there is no load on the hooks, and not require manual

separation of the lifting ring or shackle from the jaw of the hook; and

**.2.2** on-load release capability shall release the lifeboat with load on the hooks. This release shall be so arranged as to release the lifeboat under any conditions of loading: from no load with the lifeboat waterborne to a load of 1,1 times the total mass of the lifeboat when loaded with its full complement of persons and equipment. This release capability shall be adequately protected against accidental or premature use. Adequate protection shall include special mechanical protection not normally required for off-load release, in addition to a danger sign. To prevent a premature on-load release, on-load operation of the release mechanism should require a deliberate and sustained action by the operator;

**.3** to prevent an accidental release during recovery of the boat, unless the hook is completely reset, either the hook shall not be able to support any load, or the handle or safety pins shall not be able to be returned to the reset (closed) position without excessive force. Additional danger signs shall be posted at each hook station to alert crew members to the proper method of resetting;

**.4** the release mechanism shall be so designed and installed that crew members from inside the lifeboat can clearly determine when the system is ready for lifting by:

**.4.1** directly observing that the movable hook portion or the hook portion that locks the movable hook portion in place is properly and completely reset at each hook; or

**.4.2** observing a non-adjustable indicator that confirms that the mechanism that locks the movable hook portion in place is properly and completely reset at each hook; or

**.4.3** easily operating a mechanical indicator that confirms that the mechanism that locks the movable hook portion in place is properly and completely reset at each hook;

**.5** clear operating instructions shall be provided with a suitably worded warning notice using colour coding, pictograms, and/or symbols as necessary for clarity. If colour coding is used, green shall indicate a properly reset hook and red shall indicate danger of improper or incorrect setting;

**.6** the release controls shall be clearly marked in a colour that contrasts with its surroundings;

**.7** means shall be provided for hanging-off the lifeboat to free the release mechanism for maintenance;

**.8** the fixed structural connections of the release mechanism in the lifeboat shall be designed with a calculated factor of safety of 6 based on the ultimate strength of the materials used, and the mass of the lifeboat when loaded with its full complement of

persons, fuel and equipment, assuming the mass of the lifeboat is equally distributed between the falls, except that the factor of safety for the hanging-off arrangement may be based upon the mass of the lifeboat when loaded with its full complement of fuel and equipment plus 1000 kg; and

**.9** where a single fall and hook system is used for launching a lifeboat or rescue boat in combination with a suitable painter, the requirements of 6.13.7.6.2.2 and 6.13.7.6.3 need not be applicable; in such an arrangement a single capability to release the lifeboat or rescue boat, only when it is fully waterborne, will be adequate.

**6.13.7.7** Every lifeboat shall be fitted with a device to secure a painter near its bow. The device shall be such that the lifeboat does not exhibit unsafe or unstable characteristics when being towed by the ship making headway at speeds up to 5 knots in calm water. Except for free-fall lifeboats, the painter securing device shall include a release device to enable the painter to be released from inside the lifeboat, with the ship making headway at speeds up to 5 knots in calm water.

**6.13.7.8** Every lifeboat which is fitted with a fixed two-way VHF radiotelephone apparatus with an antenna which is separately mounted shall be provided with arrangements for siting and securing the antenna effectively in its operating position.

**6.13.7.9** Lifeboats intended for launching down the side of a ship shall have skates and fenders as necessary to facilitate launching and prevent damage to the lifeboat.

**6.13.7.10** A manually controlled exterior light shall be fitted outside the lifeboat. The light shall be white and be capable of operating continuously for at least 12 h with a luminous intensity of not less than 4,3 cd in all directions of the upper hemisphere. However if the light is a flashing light it shall flash at a rate of not less than 50 flashes and not more than 70 flashes per min for the 12 h operating period with an equivalent effective luminous intensity.

**6.13.7.11** A manually controlled interior light shall be fitted inside the lifeboat capable of continuous operation for a period of at least 12 h. It shall produce an arithmetic mean luminous intensity of not less than 0.5 cd when measured over the entire upper hemisphere to permit reading of survival and equipment instructions; however, oil lamps shall not be permitted for this purpose.

**6.13.7.12** Every lifeboat shall be so arranged as an adequate view forward, aft and to both sides is provided from the control and steering position for safe launching and manoeuvring the lifeboat.

#### **6.13.8 Lifeboat equipment.**

**6.13.8.1** All items of lifeboat equipment, whether required by this paragraph or elsewhere in 6.13, shall

be secured within the lifeboat by lashings, storage in lockers or compartments, storage in brackets or similar mounting arrangements or other suitable means. However, in the case of a lifeboat to be launched by falls the boat-hooks shall be kept free for fending off purposes. The equipment shall be secured in such a manner as not to interfere with any abandonment procedures. All items of lifeboat equipment shall be as small and of as little mass as possible and shall be packed in a suitable and compact form. Except where otherwise stated, the normal equipment of every lifeboat shall consist of:

**.1** except for free-fall lifeboats, sufficient buoyant oars to make headway in calm seas. Thole pins, crutches or equivalent arrangements shall be provided for each oar provided. Thole pins or crutches shall be attached to the boat by lanyards or chains;

**.2** two boat-hooks;

**.3** one buoyant bailer and two buckets;

**.4** a survival manual;

**.5** an operational compass which is luminous or provided with suitable means of illumination. In a totally enclosed lifeboat, the compass shall be permanently fitted at the steering position; in any other lifeboat, it shall be provided with a binnacle if necessary to protect it from the weather, and suitable mounting arrangements;

**.6** a sea-anchor of adequate size fitted with a shock-resistant hawser which provides a firm hand grip when wet. The strength of the sea-anchor, hawser and tripping line if fitted shall be adequate for all sea conditions;

**.7** two efficient painters of at least 14 mm in diameter each with a breaking load not less than 0,35 of the lifeboat's mass with full complement of persons, equipment and engine and of a length equal to not less than twice the distance from the stowage position of the lifeboat to the waterline in the lightest sea-going condition or 15 m, whichever is greater. On lifeboats to be launched by free-fall launching, both painters shall be stowed near the bow ready for use. On other lifeboats, one painter attached to the release device required by 6.13.7.7 shall be placed at the forward end of the lifeboat and the other shall be firmly secured at or near the bow of the lifeboat ready for use;

**.8** two hatches, one at each end of the lifeboat;

**.9** watertight receptacles containing a total of 3 l of fresh water as specified in 6.8.5.1.19 for each person the lifeboat is permitted to accommodate, of which either 1 l per person may be replaced by a desalting apparatus capable of producing an equal amount of fresh water in 2 days, or 2 l per person may be replaced by a manually powered reverse osmosis desalinator as described in 6.13.7.5 capable of producing an equal amount of fresh water in 2 days;

**.10** one rustproof dipper with lanyard;

**.11** one rustproof graduated drinking vessel;

**.12** a food ration as described in 6.8.5.1.18 totalling not less than 10 000 kJ for each person the lifeboat is permitted to accommodate; these rations shall be kept in airtight packaging and be stowed in a watertight container;

**.13** four rocket parachute flares complying with the requirements of 6.7.1;

**.14** six hand flares complying with the requirements of 6.7.2;

**.15** two buoyant smoke signals complying with the requirements of 6.7.3;

**.16** one waterproof electric torch suitable for Morse signalling together with one spare set of batteries and one spare bulb in a waterproof container;

**.17** one daylight signalling mirror (heliograph) with instructions for its use;

**.18** one copy of the illustrated table of the life-saving signals in a waterproof container or made of a watertight material;

**.19** one signal whistle or one equivalent sound signal providing a sound pressure level of about 100 dB at a distance of 1 m;

**.20** a first-aid outfit in a waterproof case capable of being closed tightly after use;

**.21** anti-seasickness medicine sufficient for at least 48 h and one seasickness bag for each person;

**.22** a jack-knife attached to the lifeboat by a lanyard;

**.23** three tin openers;

**.24** two buoyant rescue quoits attached to not less than 30 m of buoyant line;

**.25** if the lifeboat is not automatically self-bailing, a manual pump suitable for effective bailing;

**.26** one set of fishing tackle;

**.27** one set of tools and spares for the engine;

**.28** portable fire extinguishing equipment of an approved type suitable for extinguishing oil fires;

**.29** a searchlight with a horizontal and vertical sector of at least 6° and a measured luminous intensity of 2500 cd which can work continuously for not less than 3 h;

**.30** one radar reflector, unless a survival craft radar transponder is fitted in the lifeboat;

**.31** thermal protective aids complying with the requirements of 6.6 sufficient for 10 per cent of the number of persons the lifeboat is permitted to accommodate but not less than two;

**.32** lifeboats intended for the ships engaged in voyages in which, in the opinion of the Register (depending on their purpose and duration) the items specified in 6.13.8.1.12 and 6.13.8.1.26 are unnecessary, the Register may allow these items to be dispensed with.

**6.13.8.2** Lifeboats intended for the coastal ships not engaged in the international voyages shall be equipped with the following items:

- .1 one buoyant oar for each thwart with a rowlock;
- .2 one bailer and one bucket;
- .3 one painter attached to the stem and ready for use (dimensions according to 6.13.8.1.7);
- .4 six hand flares in watertight containers giving a bright red light;
- .5 the items specified in 6.13.8.1.19 and 6.13.8.1.20.

**6.13.9 Lifeboat markings.**

**6.13.9.1** The number of persons for which the lifeboat is approved shall be clearly marked on it in clear permanent characters.

**6.13.9.2** The name and port of registry of the ship to which the lifeboat belongs shall be marked on each side of the lifeboat's bow in block capitals of the Roman alphabet.

**6.13.9.3** Marking permitting to identify the ship to which the lifeboat belongs and the lifeboat's number shall be made in such a way that it is visible from above.

**6.14 PARTIALLY ENCLOSED LIFEBOATS**

**6.14.1** Partially enclosed lifeboats shall comply with the requirements of 6.13 and the present Chapter.

**6.14.2** Partially enclosed lifeboats shall be provided with permanently attached rigid covers extending over not less than 20 per cent of the length of the lifeboat from the stem and not less than 20 per cent of the length of the lifeboat from the aftermost part of the lifeboat. The lifeboat shall be fitted with a permanently attached foldable canopy which together with the rigid covers completely encloses the occupants of the lifeboat in a weatherproof shelter and protects them from exposure.

The lifeboat shall have entrances at both ends and on each side. Entrances in the rigid covers shall be weathertight when closed.

The canopy shall comply with the following requirements:

- .1 be provided with adequate rigid sections or battens to permit its erection;
- .2 can be easily erected by not more than two persons within not more than 2 min;
- .3 provide insulation to protect the occupants against heat and cold by means of not less than two layers of material separated by an air gap or other equally efficient means. Means shall be provided to prevent accumulation of water in the air gap;
- .4 its exterior shall be of a highly visible colour and its interior shall be of a colour which does not irritate the occupants;

- .5 entrances in the canopy are provided with efficient adjustable closing arrangements which can be easily and quickly opened and closed from inside or outside so as to permit ventilation but exclude seawater, wind and cold; means shall be provided for holding the entrances securely in the open and closed position;

- .6 with the entrances closed, it admits sufficient air for the occupants at all times;

- .7 have means for collecting rainwater;

- .8 the occupants can escape in the event of the lifeboat capsizing.

**6.14.3** The interior of the lifeboat shall be of a light colour which does not cause discomfort to the occupants.

**6.14.4** If a fixed two-way VHF radiotelephone apparatus is fitted in the lifeboat, it shall be installed in a cabin large enough to accommodate the radiotelephone apparatus and the operator. No separate cabin is required if the construction of the lifeboat provides a sheltered space at which operational capacity of the apparatus is not affected if the boat is flooded by water up to the level of upper seat pans.

**6.15 TOTALLY ENCLOSED LIFEBOATS**

**6.15.1** Totally enclosed lifeboats shall comply with the requirements of 6.13 as well as with the requirements of the present Chapter.

**6.15.2 Enclosure.**

Every totally enclosed lifeboat shall be provided with a rigid watertight enclosure which completely encloses the lifeboat. The enclosure shall comply with the following requirements:

- .1 protect the occupants against heat and cold;

- .2 access to the lifeboat shall be provided by hatches which can be closed to make the lifeboat watertight;

- .3 except for free-fall lifeboats, hatches are positioned so as to allow launching and recovery operations to be performed without any occupant having to leave the enclosure;

- .4 provide reliable and easy opening and closing of access hatch covers from both inside and outside. Hatch covers shall be equipped with means to hold them securely in open position;

- .5 except for a free-fall lifeboat, it is possible to row the lifeboat;

- .6 with the hatches closed and without significant leakage to support the entire mass of the lifeboat including all equipment, machinery and its full complement of persons, when the lifeboat is in a capsized position;



.7 have windows or portholes which admit sufficient daylight to the inside of the lifeboat with the hatches closed;

.8 its exterior shall be of a highly visible colour and its interior of a light colour which does not irritate the occupants;

.9 have handrails providing a secure handhold for persons moving about the exterior of the lifeboat;

.10 persons shall have access to their seats from an entrance without having to climb over thwarts or other obstructions;

.11 during operation of the engine with the enclosure closed, the atmospheric pressure inside the lifeboat shall never be above or below the outside atmospheric pressure by more than 20 hPa.

#### **6.15.3 Capsizing and re-righting.**

**6.15.3.1** Except in free-fall lifeboats, a safety belt shall be fitted at each indicated seating position. The safety belt shall be designed to hold a person with a mass of 100 kg securely in place when the lifeboat is in a capsized position.

Each set of safety belts for a seat shall be of a colour which contrasts with the belts for seats immediately adjacent. Free-fall lifeboats shall be fitted with a safety harness at each seat in contrasting colour designed to hold a person with a mass of 100 kg securely in place during a free-fall launch as well as with the lifeboat in capsized position.

**6.15.3.2** The stability of the lifeboat shall be such that it is inherently or automatically self-righting when loaded with its full or a partial complement of persons and equipment and all entrances and openings are closed watertight and the persons are secured with safety belts.

**6.15.3.3** The lifeboat shall be capable of supporting its full complement of persons and equipment when the lifeboat is in the damaged condition prescribed in 6.13.1.1 and its stability shall be such that in the event of capsizing, it will automatically attain a position that will provide an above-water escape for its occupants. When the lifeboat is in the stable flooded condition, the water level inside the lifeboat, measured along the seatback, shall not be more than 500 mm above the seat pan at any occupant seating position.

**6.15.3.4** The design of all engine exhaust pipes, air ducts and other openings shall be such that water is excluded from the engine when the lifeboat capsizes and re-rights.

#### **6.15.4 Lifeboat propulsion.**

**6.15.4.1** The engine and transmission shall be controlled from the helmsman's position.

**6.15.4.2** The engine and engine installation shall be capable of running in any position during capsizing and continue to run after the lifeboat returns to the upright or shall automatically stop on

capsizing and be easily restarted after the lifeboat returns to the upright. The design of the fuel and lubricating systems shall prevent the loss of fuel and the loss of more than 250 ml of lubricating oil from the engine during capsizing.

**6.15.4.3** Air-cooled engines shall have a duct system to take in cooling air from, and exhaust it to, the outside of the lifeboat. Manually operated dampers shall be provided to enable cooling air to be taken in from, and exhausted to, the interior of the lifeboat.

#### **6.15.5 Construction and fendering.**

Notwithstanding the requirements of 6.13.1.6 a totally enclosed lifeboat shall be so constructed and fendered as to ensure that the lifeboat renders protection against harmful accelerations resulting from an impact of the lifeboat, when loaded with its full complement of persons and equipment, against the ship's side at an impact velocity of not less than 3,5 m/s.

### **6.16 FREE-FALL LIFEBOATS**

**6.16.1** Free-fall lifeboats shall comply with the requirements of 6.15 and in addition shall comply with the requirements of this section.

**6.16.2** The carrying capacity of a free-fall lifeboat is the number of persons that can be provided with a seat without interfering with the means of propulsion or the operation of any of the lifeboat's equipment. The width of the seat shall be at least 430 mm. Free clearance in front of the backrest shall be at least 635 mm. The backrest shall extend at least 1000 mm above the seatpan.

**6.16.3** Each free-fall lifeboat shall make positive headway immediately after water entry and shall not come into contact with the ship after a free-fall launching against a trim of up to 10° and a heel of up to 20° either way from the certification height when fully equipped and loaded with:

- .1 its full complement of persons;
- .2 occupants so as to cause the centre of gravity to be in the most forward position;
- .3 occupants so as to cause the centre of gravity to be in the most aft position; and
- .4 its operating crew only.

**6.16.4** For oil tankers, chemical tankers and gas carriers with a final angle of heel greater than 20° calculated in accordance with the requirements of Part V "Subdivision" of Rules for the Classification and Construction of Sea-Going Ships, a lifeboat shall be capable of being free-fall launched at the final angle of heel and on the base of the final waterline of that calculation.

**6.16.5** Each free-fall lifeboat shall be of sufficient strength to withstand, when loaded with its full complement of persons and equipment, a free-fall

launch from a height of at least 1,3 times the free-fall certification height.

**6.16.6** Each free-fall lifeboat shall be so constructed as to ensure that the lifeboat is capable of rendering protection against harmful accelerations resulting from being launched from the height for which it shall be certified in calm water under unfavourable conditions of trim of up to 10° and heel of up to 20° either way when it is fully equipped and loaded with:

- .1 its full complement of persons;
- .2 occupants so as to cause the centre of gravity to be in the most forward position;
- .3 occupants so as to cause the centre of gravity to be in the most aft position;
- .4 the operating crew only.

**6.16.7** Each free-fall lifeboat shall be fitted with a release system which shall:

.1 have two independent activation systems for the release mechanisms which may only be operated from inside the lifeboat and be marked in a colour that contrasts with its surroundings;

.2 be so arranged as to release the boat under any condition of loading from no load up to at least 200 per cent of the normal load caused by the fully equipped lifeboat when loaded with the number of persons for which it shall be approved;

.3 be adequately protected against accidental or premature use;

.4 be designed to test the release system without launching the lifeboat;

.5 be designed with a factor of safety of 6 based on the ultimate strength of the materials used.

**6.16.8** In addition to the requirements of 6.13.1.8 the Certificate of Approval for a free-fall lifeboat shall also state:

- .1 free-fall certification height;
- .2 required launching ramp length; and
- .3 launching ramp angle for the free-fall certification height.

#### 6.17 LIFEBOATS WITH A SELF-CONTAINED AIR SUPPORT SYSTEM

**6.17.1** Lifeboats with a self-contained air support system shall comply with the requirements of 6.15 and shall be equipped with the compressed air system. The capacity of compressed air cylinders of this system shall be sufficient to ensure safety of people and reliable functioning of the engine for at least 10 min. with all entrances closed. During this period the atmospheric pressure inside the lifeboat shall never fall below the outside atmospheric pressure nor shall it exceed this pressure by more than 20 mbar. The system shall have visual indicators to indicate the pressure of the air supply at all times.

#### 6.18 FIRE-PROTECTED LIFEBOATS

**6.18.1** A fire-protected lifeboat shall comply with the requirements of 6.17 and, in addition, shall provide protection of the number of persons it is permitted to accommodate when subjected to a continuous oil fire that envelops the lifeboat for a period of not less than 8 min.

**6.18.2** The lifeboat shall be provided with detailed instructions on operation in fire conditions, as well as with the first aid outfit for burns and for CO poisoning.

**6.18.3** Under the conditions specified in 6.18.1, CO concentration inside the lifeboat shall not exceed 0,2 mg/l and CO<sub>2</sub> concentration — 3 per cent by volume.

##### 6.18.4 Water spray system.

A lifeboat which has a water spray fire-protection system shall comply with the following requirements:

.1 water for the system shall be drawn from the sea by a self-priming motor pump, and it shall be possible to turn on and turn off the flow of water over the exterior of the lifeboat;

.2 the seawater intake shall be so arranged as to prevent the intake of flammable liquids from the sea surface;

.3 the system shall be arranged for flushing with fresh water and allowing complete drainage.

**6.18.5** Water spray system or thermal insulation of the hull shall provide air temperature inside the lifeboat at the level of sitting person's head not over 60 °C under the conditions specified in 6.18.1.

#### 6.19 RESCUE BOATS

##### 6.19.1 General.

**6.19.1.1** Except as provided by this section, all rescue boats shall comply with the requirements of 6.13.1 to 6.13.7.4 (except 6.13.6.9) and 6.13.7.6, 6.13.7.7, 6.13.7.9, 6.13.7.10 and 6.13.9. A lifeboat may be approved and used as a rescue boat if it meets all of the requirements of this section, if it successfully completes the testing for a rescue boat required by 1.3.2 and if its stowage, launching and recovery arrangements on the ship meet all of the requirements for a rescue boat.

**6.19.1.2** Notwithstanding the requirements of 6.13.4 required buoyant material for rescue boats may be installed external to the hull, provided it is adequately protected against damage and is capable of withstanding exposure as specified in 6.19.3.3.

**6.19.1.3** Rescue boats may be either of rigid or inflated construction or a combination of both and shall:

**.1** be not less than 3,8 m and not more than 8,5 m in length;

**.2** be capable of carrying at least five seated persons and a person lying on a stretcher all wearing immersion suits, and lifejackets if required. Notwithstanding 6.13.1.4, seating, except for the helmsman, may be provided on the floor, provided that the seating space analysis in accordance with 6.13.2.2.2 uses shapes similar to figure 6.13.2.2, but altered to an overall length of 1190 mm to provide for extended legs. No part of a seating space shall be on the gunwale, transom, or on inflated buoyancy at the sides of the boat.

On agreement with the Register cargo ships under 500 gross tonnage and fishing vessels under 45 m in length may carry rescue boats of the reduced carrying capacity.

**6.19.1.4** Rescue boats which are a combination of rigid and inflated construction shall comply with the appropriate requirements of this Chapter.

**6.19.1.5** Unless the rescue boat has adequate sheer, it shall be provided with a bow cover extending for not less than 15 per cent of its length.

**6.19.1.6** Every rescue boat shall be provided with sufficient fuel, suitable for use throughout the temperature range expected in the area in which the ship operates, and be capable of manoeuvring at a speed of at least 6 knots and maintaining that speed, for a period of at least 4 h, when loaded with its full complement of persons and equipment.

**6.19.1.7** Rescue boats shall have sufficient mobility and manoeuvrability in a seaway to enable persons to be retrieved from the water, marshal liferafts and tow the largest liferaft carried on the ship when loaded with its full complement of persons and equipment or its equivalent at a speed of at least 2 knots.

**6.19.1.8** A rescue boat shall be fitted with an inboard engine or outboard motor. If it is fitted with an outboard motor, the rudder and tiller may form part of the engine. Notwithstanding the requirements of 6.13.6.1, rescue boats may be fitted with petrol-driven outboard motors with an approved fuel system provided the fuel tanks are specially protected against fire and explosion.

**6.19.1.9** Arrangements for towing shall be permanently fitted in rescue boats and shall be sufficiently strong to marshal or tow liferafts as required by 6.19.1.7.

**6.19.1.10** Rescue boats shall be fitted with weathertight stowage for small items of equipment.

**6.19.1.11** Unless expressly provided otherwise, every rescue boat shall be provided with effective means of bailing or be automatically self-bailing.

**6.19.1.12** Every rescue boat shall be so arranged that an adequate view forward, aft and to both sides is provided from the control and steering position for safe launching and manoeuvring and, in particular, with regard to visibility of areas and crew members essential to man-overboard retrieval and marshalling of survival craft.

#### **6.19.2 Rescue boat equipment.**

**6.19.2.1** All items of rescue boat equipment, with the exception of boat hooks which shall be kept free for fending off purposes, shall be secured within the rescue boat by lashings, storage in lockers or compartments, storage in brackets or similar mounting arrangements, or other suitable means. The equipment shall be secured in such a manner as not to interfere with any launching or recovery procedures. All items of rescue boat equipment shall be as small and of as little mass as possible and shall be packed in suitable and compact form.

**6.19.2.2** The normal equipment of every rescue boat shall consist of:

**.1** sufficient number of buoyant oars or paddles to make headway in calm seas. Thole pins, crutches or equivalent arrangements shall be provided for each oar. Thole pins or crutches shall be attached to the boat by lanyards or chains;

**.2** a buoyant bailer;

**.3** a binnacle containing an efficient compass with luminous card or provided with suitable means of illumination;

**.4** a sea-anchor and tripping line with a hawser of adequate strength not less than 10 m in length;

**.5** a painter of sufficient length and strength, attached to the release device complying with the requirements of 6.13.7.7 and placed at the forward end of the rescue boat;

**.6** one buoyant line, not less than 50 m in length, of sufficient strength to tow a liferaft as required by 6.19.1.7;

**.7** one waterproof electric torch suitable for Morse signalling together with one spare set of batteries and one spare bulb in a waterproof container;

**.8** one whistle or equivalent sound signal;

**.9** a first-aid outfit in a waterproof case capable of being closed tightly after use;

**.10** two buoyant rescue quoits, attached to not less than 30 m of buoyant line;

**.11** a searchlight with a horizontal and vertical sector of at least 6° and a measured luminous intensity of 2500 cd which can work continuously for not less than 3 h;

**.12** an efficient radar reflector;

**.13** thermal protective aids complying with the requirements of 6.6 sufficient for 10 per cent of the number of persons the rescue boat is permitted to accommodate or two, whichever is greater;

**.14** portable fire extinguishing equipment of an approved type suitable for extinguishing oil fires.

**6.19.2.3** In addition to the equipment required by 6.19.2.2, the normal equipment of every rigid rescue boat shall include a boat hook, a bucket, a knife or a hatchet.

**6.19.2.4** In addition to the equipment required by 6.19.2.2, the normal equipment of every inflated rescue boat shall include:

- .1** a buoyant safety knife;
- .2** two sponges;
- .3** an efficient manually operated bellows or pump;
- .4** a repair kit for repairing punctures in a suitable container;
- .5** a safety boat hook.

**6.19.3 Additional requirements for inflated rescue boats.**

**6.19.3.1** The requirements of 6.13.1.3 and 6.13.1.5 do not apply to inflated rescue boats.

**6.19.3.2** An inflated rescue boat when suspended by its bridle or lifting hook shall be:

- .1** of sufficient strength and rigidity to enable it to be lowered and recovered with its full complement of persons and equipment;
- .2** of sufficient strength to withstand a load of 4 times the mass of its full complement of persons and equipment at an ambient temperature of  $20+3\text{ }^{\circ}\text{C}$  with all relief valves inoperative;
- .3** of sufficient strength to withstand a load of 1,1 times the mass of its full complement of persons and equipment at an ambient temperature of  $-30\text{ }^{\circ}\text{C}$  with all relief valves operative.

**6.19.3.3** Inflated rescue boats shall be so constructed as to be capable of withstanding exposure when stowed on an open deck of ship at sea and be capable to withstand exposure for 30 days afloat in all sea conditions.

**6.19.3.4** In addition to complying with the requirements of 6.13.9 inflated rescue boats shall be marked with a serial number, the manufacturer's name or trade mark and the date of manufacture.

**6.19.3.5** The buoyancy of an inflated rescue boat shall be provided by either a single tube subdivided into at least five separate compartments of approximately equal volume or two separate tubes neither exceeding 60 per cent of the total volume. The buoyancy tubes shall be so arranged that the intact compartments shall be able to support the number of persons which the rescue boat is permitted to accommodate, each having a mass of 75 kg, when seated in their normal positions with positive freeboard over the rescue boat's entire periphery under the following conditions:

- .1** with the forward buoyancy compartment deflated;

- .2** with the entire buoyancy on one side of the rescue boat deflated; and

- .3** with the entire buoyancy on one side and the bow compartment deflated.

**6.19.3.6** The buoyancy tubes forming the boundary of the inflated rescue boat shall on inflation provide a volume of not less than  $0,17\text{ m}^3$  for each person the rescue boat is permitted to accommodate.

**6.19.3.7** Each buoyancy compartment shall be fitted with a non-return valve for manual inflation and means for deflation. A safety relief valve shall also be fitted.

**6.19.3.8** Underneath the bottom and on vulnerable places on the outside of the inflated rescue boat, rubbing strips shall be provided.

**6.19.3.9** Where a transom is fitted it shall not be inset by more than 20 per cent of the overall length of the rescue boat.

**6.19.3.10** Suitable patches shall be provided for securing the painters fore and aft and the becketed lifelines inside and outside the boat.

**6.19.4 Fast rescue boats.**

**6.19.4.1** The fast rescue boat and its launching appliances shall be such as to enable it to be safely launched and retrieved under adverse weather and sea conditions.

**6.19.4.2** All fast rescue boats shall comply with the requirements to rescue boats except for 6.13.1.6, 6.13.6.9, 6.13.7.2, 6.19.1.3, 6.19.1.6 and 6.19.1.11 and also comply with the requirements of this Chapter.

**6.19.4.3** Notwithstanding 6.19.1.3.1 fast rescue boats shall have a full length of not less than 6 meters and not more than 8,5 meters, including inflated structures or fixed fenders.

**6.19.4.4** Fully equipped fast rescue boats shall be capable of manoeuvring for at least 4 hours at a speed of at least 20 knots in calm water with a crew of 3 persons and at least 8 knots with a full complement of persons and equipment.

**6.19.4.5** Fast rescue boats shall be self-righting or capable of being readily righted by not more than two of their crew.

**6.19.4.6** Fast rescue boats shall be either self-bailing or be capable of being rapidly cleared of water.

**6.19.4.7** Fast rescue boats shall be steered by a wheel at a helmsman's position remote from the tiller. An emergency steering system providing direct control of the rudder, water jet or outboard motor shall be also provided.

**6.19.4.8** Engines in fast rescue boat shall stop automatically or be stopped by the helmsman's emergency release switch shall the rescue boat capsize. When the rescue boat has righted, each engine or motor shall be capable of being restarted, provided the helmsman's emergency release, is fitted, has been reset. The design of the fuel and lubricating

systems shall prevent the loss of more than 250 ml of fuel or lubricating oil from the propulsion system shall the rescue boat capsize.

**6.19.4.9** Fast rescue boats shall, if possible, be equipped with an easily and safely operated fixed single point suspension arrangement or equivalent.

**6.19.4.10** A rigid fast rescue boat shall be constructed in such a way that, when suspended by its lifting point it is sufficient strength to withstand a load without residual deflection on removal of load of 4 times the mass of its full complement of persons and equipment.

**6.19.4.11** The normal equipment of the fast rescue boat shall include a hands free and portable VHF radiocommunication set.

**6.19.4.12** The crew of the fast rescue boat shall consist of at least the helmsman and two crew members trained and drilled regularly having regard to the Seafarers' Training, Certification and Watch-keeping (STCW) Code requirements.

#### **6.19.5 Outboard petrol engines.**

Outboard petrol engines shall comply with the requirements of 6.13.6.2 to 6.13.6.4, 6.13.6.8, 6.13.6.9, 6.13.6.11, 6.13.6.13 and additionally with the following requirements.

**6.19.5.1** The engine shall be equipped with a speed regulator to provide overspeed protection, oil low level and oil (cooling liquid) temperature indicators. Means of reversing and setting the throttle control at any position shall be provided.

**6.19.5.2** Anti-syphon devices shall be provided in the fuel tanks and fuel piping to prevent fuel spillage when the hose is disconnected. Applicable flexible joints and hoses shall be fireproof and resistant to the effects of conducted medium.

**6.19.5.3** The fuel tank shall be of a design recommended by the manufacturer of the engines and be securely attached to the boat.

**6.19.5.4** It is recommended to fit the motor with means of supplying power to the truck light.

### **6.20 LAUNCHING AND EMBARKATION APPLIANCES**

#### **6.20.1 General.**

**6.20.1.1** With the exception of the secondary means of launching for free-fall lifeboats, each launching appliance shall be so arranged that the fully equipped survival craft or rescue boat it serves can be safely launched against unfavourable conditions of trim of up to 10° and heel of up to 20° either way:

**.1** when boarded, as required by 3.3 or 4.3, by its full complement of persons; and

**.2** with not more than the required operating crew on board.

**6.20.1.2** Notwithstanding the requirements of 6.20.1.1, lifeboat launching appliances for oil tankers, chemical tankers and gas carriers with a final angle of heel greater than 20° calculated in accordance with Part V "Subdivision" of Rules for the Classification and Construction of Sea-Going Ships shall be capable of operating at the final angle of heel on the lower side of the ship taking into consideration the final damaged waterline of the ship.

**6.20.1.3** A launching appliance shall not depend on any means other than gravity or stored mechanical power supplies to launch the survival craft or rescue boat it serves in the fully loaded and equipped condition and also in the light condition.

**6.20.1.4** Each launching appliance shall be so constructed that a minimum amount of routine maintenance is necessary. All parts requiring regular maintenance by the ship's crew shall be readily accessible and easily maintained.

**6.20.1.5** The launching appliance and its attachments other than winch brakes shall be of sufficient strength to withstand a factory static proof load test of not less than 2,2 times the maximum working load.

**6.20.1.6** Structural members and all blocks, falls, padeyes, links, fastenings and all other fittings used in connection with launching equipment shall be designed with not less than a minimum factor of safety on the basis of the maximum working load assigned and the ultimate strength of the material used for construction. A minimum factor of safety of 4,5 shall be applied to all davit and winch structural members and a minimum factor of safety of 6 shall be applied to falls, suspension chains, links and blocks on the basis of the ultimate strength of the material.

**6.20.1.7** Each launching appliance shall, as far as practicable, remain effective under conditions of icing.

**6.20.1.8** A lifeboat launching appliance shall be capable of recovering the lifeboat with its crew.

**6.20.1.9** Each rescue boat launching appliance shall be fitted with a powered winch motor capable of raising the rescue boat from the water with its full rescue boat complement of persons and equipment at a rate of not less than 0,3 m/s.

**6.20.1.10** The arrangements of the launching appliance shall be such as to enable safe boarding of the survival craft in accordance with the requirements of 6.8.4.2, 6.8.4.3, 6.13.3.1 and 6.13.3.2.

**6.20.1.11** Rescue boat launching appliances shall be provided with foul weather recovery strops for recovery where heavy fall blocks constitute a danger.

#### **6.20.2 Launching appliances using falls and a winch.**

**6.20.2.1** Every launching appliance using falls and a winch, except for secondary launching appli-

ances for free-fall lifeboats, shall comply with the requirements of 6.20.1 and in addition shall comply with the requirements of this paragraph.

**6.20.2.2** The launching mechanism shall be so arranged that it may be actuated by one person from a position on the ship's deck and, except for secondary launching appliances for free-fall lifeboats, from a position within the survival craft or rescue boat. When launched by a person on the deck, the survival craft or rescue boat shall be visible to that person.

**6.20.2.3** Falls shall be of rotation-resistant and corrosion-resistant steel wire rope.

**6.20.2.4** In the case of a multiple drum winch the falls shall be so arranged as to wind off the drums at the same rate when lowering, and to wind on to the drums evenly at the same rate when hoisting, unless an efficient compensatory device is fitted.

**6.20.2.5** The winch brakes of a launching appliance shall be of sufficient strength to withstand:

**.1** a static test with a proof load of not less than 1,5 times the maximum working load;

**.2** a dynamic test with a proof load of not less than 1,1 times the maximum working load at maximum lowering speed.

**6.20.2.6** An efficient hand gear shall be provided for recovery of each liferaft, lifeboat and rescue boat. Hand gear handles or wheels shall not be rotated by moving parts of the winch when the liferaft, lifeboat or rescue boat is being lowered or when being hoisted by power.

**6.20.2.7** Where davit arms are recovered by power, devices shall be fitted which will automatically cut off the power before the davit arms reach the stops in order to avoid overstressing the falls or davits, unless the motor is designed to prevent such overstressing.

**6.20.2.8** The speed at which the fully loaded survival craft or rescue boat is lowered to the water shall not be less than that determined by the formula:

$$S = 0,4 + 0,02H \quad (6.20.2.8)$$

where  $H$  = the height from the davit head to the waterline with the ship at the lightest sea-going condition, m.

**6.20.2.9** The lowering speed of a fully equipped liferaft without persons onboard shall be at least 50 per cent, the lowering speed of other survival craft, fully equipped but without persons on board, shall be at least 70 per cent of that required by 6.20.2.8.

**6.20.2.10** The maximum lowering speed shall be established upon agreement with the Register having regard to the design of the survival craft or rescue boat, the protection of the occupants from excessive forces, and the strength of the launching arrangements taking into account inertia forces during an

emergency stop. The launching appliances shall be fitted with the means preventing the exceeding of this speed.

**6.20.2.11** Every launching appliance shall be fitted with brakes capable of stopping the descent of the survival craft or rescue boat and holding them securely when loaded with its full complement of persons and equipment; where necessary, the brake pads shall be protected from water and oil.

**6.20.2.12** Manual brakes shall be so arranged that the brake is always applied unless the operator either on deck or in survival craft or rescue boat, holds the brake control handle in the "off" position.

**6.20.2.13** A lifeboat launching appliance shall be provided with means for hanging-off the lifeboat to free the on-load release mechanism for maintenance.

### **6.20.3 Float-free launching.**

Where a survival craft requires a launching appliance and is also designed to float free, the float-free release of the survival craft from its stowed position shall be automatic.

### **6.20.4 Launching appliances for free-fall lifeboats.**

**6.20.4.1** Every free-fall launching appliance shall comply with the applicable requirements of 6.20.1 and, in addition, shall comply with the requirements of this paragraph.

**6.20.4.2** The launching appliance shall be designed and installed so that it and the lifeboat it serves operate as a system to protect the occupants from harmful acceleration forces as required by 6.16.6, and to ensure effective clearing of the ship as required by 6.16.3 and 6.16.4.

**6.20.4.3** The launching appliance shall be constructed so as to prevent sparking and incendiary friction during the launching of the lifeboat.

**6.20.4.4** The launching appliance shall be designed and arranged so that in its ready to launch position, the distance from the lowest point on the lifeboat it serves to the water surface with the ship in its lightest seagoing condition does not exceed the lifeboat's free-fall certification height, taking into consideration the requirements of 6.16.3.

**6.20.4.5** The launching appliance shall be arranged so as to preclude accidental release of the lifeboat in its unattended stowed position. If the means provided to secure the lifeboat cannot be released from inside the lifeboat, it shall be so arranged as to preclude boarding the lifeboat without first releasing it.

**6.20.4.6** The release mechanism shall be arranged so that at least two independent actions from inside the lifeboat are required in order to launch the lifeboat.

**6.20.4.7** Each launching appliance shall be provided with a secondary means to launch the lifeboat by falls. Such means shall comply with the

requirements of 6.20.1 (except 6.20.1.3) and 6.20.2 (except 6.20.2.6). It shall be capable of launching the lifeboat against unfavourable conditions of trim of up to only 2° and heel of up to only 5° either way and it need not comply with the speed requirements of 6.20.2.8 and 6.20.2.9. If the secondary launching appliance is not dependent on gravity, stored mechanical power or other manual means, the launching appliance shall be connected both to the ship's main and emergency sources of power.

**6.20.4.8** The secondary means of launching shall be equipped with at least a single off-load capability to release the lifeboat.

**6.20.5 Liferaft launching appliances.**

Every liferaft launching appliance shall comply with the requirements of 6.20.1 and 6.20.2, except with regard to embarkation in the stowed position, recovery of the loaded liferaft and that manual operation is permitted for turning out the appliance. The launching appliance shall include an automatic release hook arranged so as to prevent premature release during lowering and shall release the liferaft when waterborne. The release hook shall include a capability to release the hook under load. The on-load release control shall:

- .1 be clearly differentiated from the control which activates the automatic release function;
- .2 require at least two separate actions to operate;
- .3 with a load of 150 kg on the hook, require a force of at least 600 and not more than 700 N to release the load, or provide equivalent adequate protection against inadvertent release of the hook;
- .4 be designed such that the crew members on deck can clearly observe when the release mechanism is properly and completely set.

**6.20.6 Fast rescue boats launching appliances.**

**6.20.6.1** Each fast rescue boat launching appliance shall comply with the requirements of 6.20.1 and 6.20.2 except 6.20.2.10.

**6.20.6.2** The launching appliance shall be fitted with a device to dampen the forces due to interaction with waves when the fast rescue boat is launched and recovered. The device shall include a flexible element to soften shock forces and a dampening element to minimize oscillations.

**6.20.6.3** The winch shall be fitted with an automatic high-speed tensioning device which prevents the wire from going slack in all sea state conditions in which the fast rescue boat is intended to operate.

**6.20.6.4** The winch brake shall have a gradual action. When the fast rescue boat is lowered at full speed and brakes are applied sharply, the additional force induced in the wire due to retardation shall not exceed 0,5 times the working load of launching appliance.

**6.20.6.5** The lowering speed for a fully equipped fast rescue boat with its full complement of persons on board shall not exceed 1 m/s. Notwithstanding the requirements of 6.20.1.9, the launching appliances shall be capable of hoisting the fully equipped rescue boat with 6 persons at a speed of not less than 0,8 m/s. The appliance shall be also capable of lifting the rescue boat with the maximum number of persons that can be accommodated in the rescue boat as calculated under 6.13.2.

**6.20.6.6** At least three turns of wire shall remain on the winch after the fast rescue boat is lowered to the sea with the ship at its lightest seagoing condition, a trim of up to 10° and a heel of up to 20°, either way.

**6.20.7 Embarkation ladders.**

**6.20.7.1** Handholds shall be provided to ensure a safe passage from the deck to the head of the ladder and vice versa.

**6.20.7.2** The steps of ladder shall be:

- .1 made of hardwood, free from knots or other irregularities, smoothly machined and free from sharp edges and splinters, or of suitable material of equivalent properties;
- .2 provided with a non-slip surface either by longitudinal grooving or by the application of an approved non-slip coating;
- .3 not less than 480 mm long, 115 mm wide and 25 mm in depth, excluding any non-slip surface or coating;
- .4 equally spaced not less than 300 mm or more than 380 mm apart and secured in such a manner that they will remain horizontal.

**6.20.7.3** The sides ropes of the ladder shall be made of two uncovered manila ropes not less than 65 mm in circumference on each side. Each rope shall be continuous with no joints below the top step. Other materials may be used provided the dimensions, breaking strain, weathering, stretching and gripping properties are at least equivalent to those of manila rope. All rope ends shall be secured to prevent unravelling.

**6.20.8 Marine evacuation systems.**

**6.20.8.1** Construction of the marine evacuation system.

**6.20.8.1.1** The passage of the marine evacuation system shall provide for safe descent of person of various ages, sizes and physical capabilities wearing approved lifejackets from the embarkation station to the floating platform or survival craft.

**6.20.8.1.2** Strength and construction of the passage and platform shall be to the satisfaction of the Register.

**6.20.8.1.3** The platform if fitted shall be:

- .1 such that sufficient buoyancy will be provided for the working load. In the case of an inflatable platform, the main buoyancy chambers, which for this purpose shall include any thwarts or floor

inflatable structural members are to meet the requirements of 6.9 based upon the platform capacity except that the capacity shall be obtained by dividing by 0,25 the usable area given in 6.20.8.3.3;

.2 stable in a seaway and provide a safe working area for the system operators;

.3 of sufficient area that will provide for the securing of at least two liferafts for boarding and to accommodate at least the number of persons that at any time are expected to be on the platform. This usable platform area shall be at least equal to:

$\frac{20\% \text{ of total number of persons the Marine Evacuation System is certificated for}}{4} \text{ m}^2$

or 10 m<sup>2</sup>, whichever is greater. However, the Register may approve alternate arrangements which are demonstrated to comply with all the prescribed performance requirements;

.4 self draining;

.5 sub-divided in such a way that the loss of gas from any one compartment will not restrict its operational use as a means of evacuation. The buoyancy tubes shall be sub-divided or protected against damage occurring from contact with the ship's side;

.6 fitted with a stabilizing system to the satisfaction of the Register;

.7 restrained by a bowsing line or other positioning systems which are designed to deploy automatically and if necessary, to be capable of being adjusted to the position required for evacuation;

.8 provided with mooring and bowsing line patches of sufficient strength to securely attach the largest inflatable liferaft associated with the system.

**6.20.8.1.4** If the passage gives direct access to the survival craft, it shall be provided with a quick release arrangement.

**6.20.8.2** Performance of the marine evacuation system.

**6.20.8.2.1** A marine evacuation system shall be:

.1 capable of deployment by one person;

.2 such as to enable the total number of persons for which it is designed, to be transferred from the ship into the inflated liferafts within a period of 30 min in the case of a passenger ship and of 10 min in the case of a cargo ship from the time abandon ship signal is given;

.3 arranged such that liferafts may be securely attached to the platform and released from the platform by a person either in the liferaft or on the platform;

.4 capable of being deployed from the ship under unfavourable conditions of trim of up to 10° and heel of up to 20° either way;

.5 in the case of being fitted with an inclined slide, such that the angle of the slide to the horizontal is:

within a range of 30° to 35° when the ship is upright and in the lightest sea-going condition; and

in the case of a passenger ship, a maximum of 55° in the final stage of flooding set by the requirements of Part V "Subdivision" of Rules for the Classification and Construction of Sea-Going Ships;

.6 evaluated for capacity by means of timed evacuation deployments conducted in harbour;

.7 capable of providing a satisfactory means of evacuation in a sea state associated with a wind of force 6 on the Beaufort scale;

.8 designed to, as far as practicable, remain effective under conditions of icing;

.9 so constructed that only a minimum amount of routine maintenance is necessary. Any part requiring maintenance by the ship's crews shall be readily accessible and easily maintained.

**6.20.8.2.2** Where one or more marine evacuation systems are provided on a ship, at least 50 per cent of such systems shall be subjected to a trial deployment after installation. Subject to these deployments being satisfactory, the untried systems shall be deployed within 12 months of installation.

**6.20.8.3** Inflatable liferafts associated with marine evacuation systems.

**6.20.8.3.1** Any inflatable liferaft used in conjunction with the marine evacuation system shall:

.1 conform with the requirements of 6.9;

.2 be sited close to the system container but be capable of dropping clear of the deployed system and boarding platform;

.3 be capable of release one at a time from its stowage rack with arrangements which will enable it to be moored alongside the platform;

.4 be stowed in accordance with 2.4.4 to 2.4.6;

.5 be provided with pre-connected or easily connected retrieving lines to the platform.

**6.20.8.4** Containers for marine evacuation systems.

**6.20.8.4.1** The evacuation passage and platform shall be packed in a container that is:

.1 so constructed as to withstand hard wear under conditions encountered at sea;

.2 as far as practicable watertight, except for drain holes in the container bottom.

**6.20.8.4.2** The container shall be marked with:

.1 manufacturer's name or trade mark;

.2 serial number;

.3 name of approval authority and the capacity of the system;

.4 SOLAS;

.5 date of manufacture (month and year);

.6 date and place of last survey;

.7 maximum permitted height of stowage above waterline;

.8 stowage position on board.

**6.20.8.4.3** Launching and operating instructions shall be marked on or in the vicinity of the container.



**6.20.8.5** Marking on marine evacuation systems.

**6.20.8.5.1** The marine evacuation system shall be marked with:

- .1 manufacturer's name or trade mark;
- .2 serial number;
- .3 date of manufacture (month and year);
- .4 name of approving authority;
- .5 name and place of servicing station where it was last serviced, along with the date of servicing;
- .6 the capacity of the system.

**6.20.9 Means of rescue.**

**6.20.9.1** The means of rescue shall provide for the safe transfer of persons, including helpless persons, from the water level to the deck of the ship.

**6.20.9.2** The means of rescue shall provide an area of at least 9 m<sup>2</sup> at water level and have sufficient lighting from the ship deck.

**6.20.9.3** The means of rescue shall be one of the following.

**6.20.9.3.1** A marine evacuation system complying with the requirements of 6.20.8 providing a suitable floating platform, with a ladder or other means to ascend to the deck for able-bodied persons, and a mechanically powered means to safely hoist persons lying down. If an inclined passage of a marine evacuation system is intended to provide the means of transfer from the platform to the deck of the ship for able-bodied persons, the inclined passage shall be provided with suitable handholds or portable ladder with steps having an efficient non-slip surface.

**6.20.9.3.2** A device equipped with the floating platform which comply with the requirements of 6.8.3.1, 6.8.4.1, 6.8.5.1.1. and requirements of 6.9.2, 6.9.2.1, 6.9.2.3, 6.9.2.4, 6.9.7, 6.9.8.1, 6.9.8.2 (if fitted) and 6.9.9.1 in the case of an inflatable device; or requirements of 6.10.1, 6.10.2, 6.10.6.2 to 6.10.6.4, 6.10.6.6, 6.10.6.9, 6.10.6.10 and 6.10.7.1 in the case of a rigid device. The device shall be used by a launching appliance, complying with the requirements of 6.20.1, with a powered winch motor capable of raising the loaded device from the water to the deck of the ship with the total number of persons for which it is approved as a means of rescue at a rate of not less than 0,3 m/s. A safety device shall be fitted to prevent over stressing the launching appliance. Additionally, the device shall comply with the following:

- .1 the device shall be of a highly visible colour, and shall be protected against damage when moving against the ship's side;
- .2 the occupants shall be protected against injury caused by the launching appliance;
- .3 two boarding ramps complying with 6.9.4.1 or 6.10.4.1 shall be fitted;
- .4 the maximum number of persons permitted on the device shall be conspicuously marked;
- .5 the floor shall be self-draining;

.6 suitable means shall be provided for bowing in the device to the ship's side;

.7 one knife of a type described in 6.8.5.1.2 shall be stowed in a pocket close to each bowing line attachment patch;

.8 a special arrangement shall be fitted to close the gap between the loaded device and deck when the rescued persons board the ship;

.9 the device shall be conspicuously marked to prevent confusion with liferafts;

.10 if inflatable, the inflation system shall be quickly initiated by a manual control;

.11 means shall be provided for preventing occupants from falling from the device on impact with the ship's side.

**6.20.9.3** A means of rescue approved in compliance with the requirements of 1.3.3.

**6.21 LINE-THROWING APPLIANCES**

**6.21.1** Every line-throwing appliance shall:

- .1 be capable of throwing a line with reasonable accuracy;
- .2 include not less than four projectiles each capable of carrying the line at least 230 m in calm weather;
- .3 include not less than four lines each having a breaking strength of not less than 2 kN;
- .4 have brief instructions or diagrams clearly illustrating the use of the line-throwing appliance.

**6.21.2** The rocket, in the case of a pistol fired rocket, or the assembly, in the case of an integral rocket and line, shall be contained in a water resistant casing. In addition in the case of a pistol-fired rocket, the line and rockets together with the means of ignition shall be stowed in a container which provides protection from the weather.

**6.22 GENERAL ALARM AND PUBLIC ADDRESS SYSTEM**

**6.22.1 General emergency alarm system.**

**6.22.1.1** The general emergency alarm system shall be capable of sounding the general emergency alarm signal consisting of seven or more short blasts followed by one long blast on the ship's whistle or siren and additionally on an electrically operated bell or klaxon or other equivalent warning system, which shall be powered from the ship's main supply and the emergency source of electrical power required by Sections 9 and 19, Part XI "Electrical Equipment" of Rules for the Classification and Construction of Sea-Going Ships, as appropriate. The system shall be capable of operation from the navigation bridge and,

except for the ship's whistle, also from other strategic points.

The alarm shall continue to function after it has been triggered until it is manually turned off or is temporarily interrupted by a message on the public address system.

**6.22.1.2** The minimum sound pressure levels for the emergency alarm tone in interior and exterior spaces shall be 80 dB(A) and at least 10 dB(A) above ambient noise levels existing during normal equipment operation with the ship underway in moderate weather.

**6.22.1.3** The sound pressure levels at the sleeping position in cabins and in cabin bathrooms shall be at least 75 dB(A) and at least 10 dB(A) above ambient noise levels.

**6.22.2 Public address system.**

**6.22.2.1** The public address system shall be a loudspeaker installation enabling the broadcast of messages into all spaces where crew members or passengers, or both, are normally present, and to muster stations. Such spaces may not include under deck passageways, bosun's lockers, hospitals, pump

rooms. It shall allow for the broadcast of messages from the navigating bridge and such other places on board the ship. It shall be installed with regard to acoustically marginal conditions and not require any action from the addressee. It shall be protected against unauthorized use.

**6.22.2.2** With the ship underway in normal conditions, the minimum sound pressure levels for broadcasting emergency announcements shall be:

**.1** in interior spaces 75 dB(A) and at least 20 dB (A) above the speech interference level (with respect to cabin/state rooms, the above sound pressure levels shall also be attained during sea trials);

**.2** in exterior spaces 80 dB(A) and at least 15 dB(A) above the speech interference level.

**6.22.2.3** Where an individual loudspeaker has a device for local silencing, an override arrangement from the control station(s), including the navigating bridge, shall be provided.

**6.22.2.4** The public address system shall comply with the requirements of Chapter 3.8 and Section 11, Part IV "Radio Equipment".

## APPENDIX 1

**RECOMMENDATION ON THE USE AND FITTING OF RETRO-REFLECTIVE MATERIALS ON LIFE-SAVING APPLIANCES****1 LIFEBOATS AND RESCUE BOATS**

**1.1** Retro-reflective materials shall be fitted on top of the gunwale as well as on the outside of the boat as near the gunwale as possible. The materials shall be sufficiently wide and long to give a minimum area of 150 cm<sup>2</sup> and shall be spaced at suitable intervals (approximately 80 cm from centre to centre). If a canopy is fitted, it shall not be allowed to obscure the materials fitted on the outside of the boat, and the top of the canopy shall be fitted with retro-reflective materials similar to those mentioned above and spaced at suitable intervals (approximately 80 cm from centre to centre). In the case of partially enclosed or totally enclosed lifeboats, such materials should be placed as follows:

**.1** for detection by horizontal light beams, at suitable intervals at half the height between the gunwale and the top of the fixed cover;

**.2** for detection by vertical light beams (e.g. from helicopters), at suitable intervals around the outer portion of the horizontal (or comparable) part of the top of the fixed cover;

**.3** retro-reflective materials shall also be fitted on the bottom of lifeboats and rescue boats which are not self-righting.

**2 LIFERAFTS**

**2.1** Retro-reflective materials shall be fitted around the canopy of the liferaft. The material shall be sufficiently wide and long to give a minimum area of 150 cm<sup>2</sup> and shall be spaced at suitable intervals (approximately 80 cm from centre to centre) at a suitable height above the waterline, doorways included, if suitable. On inflatable liferafts, retro-reflective materials shall also be fitted to the underside of the floor, cross-shaped in the centre. The dimension of the cross shall be half the diameter of the liferaft, and a similar cross shall be applied to the top of the canopy.

On liferafts which are not equipped with canopies, materials which shall be sufficiently wide and long (to give a minimum area of 150 cm<sup>2</sup>) should be attached to the buoyancy chamber at suitable intervals (approximately 80 cm from centre to centre) in such a manner that they are visible both from the air and from a ship.

**3 LIFEBOUOYS**

**3.1** Retro-reflective materials of a sufficient width (approximately 5 cm) shall be applied around or on both sides of the body of the lifebuoy at four evenly-spaced points.

**4 BUOYANT APPARATUS**

**4.1** Buoyant apparatus shall be fitted with retro-reflective materials in the same manner as liferafts without canopies, always depending on the size and shape of the object. Such materials shall be visible both from the air and from a ship.

**5 LIFEJACKETS**

**5.1** Lifejackets shall be fitted with patches of retro-reflective materials with a total area of at least 400 cm<sup>2</sup> distributed so as to be useful for search from air and surface craft from all directions. In the case of a reversible lifejacket, the arrangement shall be complied with no matter which way the lifejacket is put on. Such material shall be placed as high up on the lifejacket as possible.

**6 IMMERSION SUITS**

**6.1** Immersion suits shall be fitted with patches of retro-reflective material with a total area of at least 400 cm<sup>2</sup> distributed so as to be useful for search from air and surface craft from all directions.

For an immersion suit that does not automatically turn the wearer face up, the back of the suit should be fitted with retro-reflective material with a total area of at least 100 cm<sup>2</sup>.

**7 GENERAL REMARKS**

**7.1** Retro-reflective materials shall be such as will meet the requirements of Part XIII "Materials" of Rules for the Classification and Construction of Sea-Going Ships.

**7.2** The illustrations 7.2-1 to 7.2-11 reproduced in this Appendix are intended to provide Administrations with examples from which guidance may be taken when fitting retro-reflective materials in accordance with these guidelines.

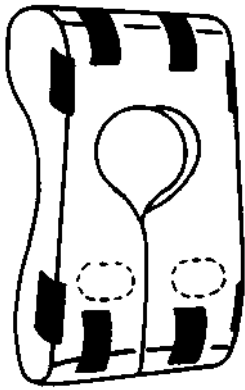

Fig. 7.2-1

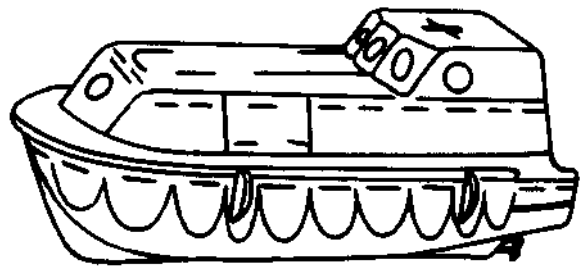

Fig. 7.2-7



Fig. 7.2-2

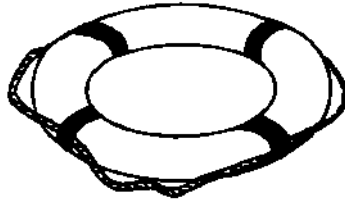

Fig. 7.2-3

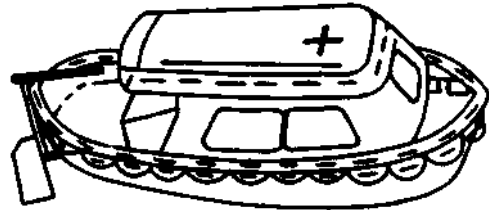

Fig. 7.2-8

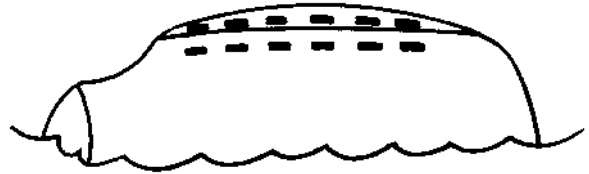

Fig. 7.2-9

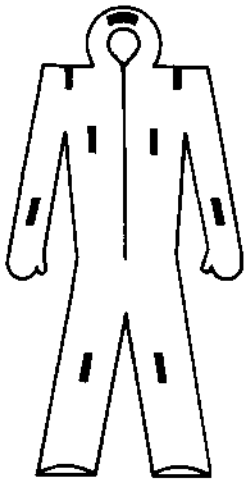

Fig. 7.2-4

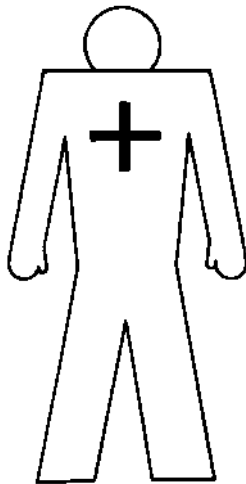

Fig. 7.2-5

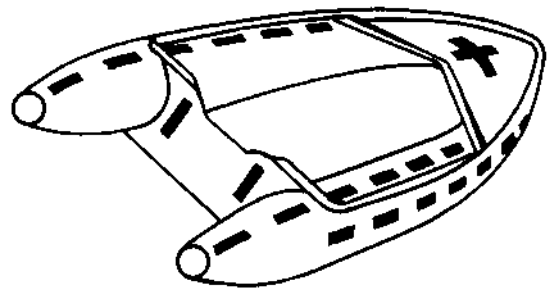

Fig. 7.2-10

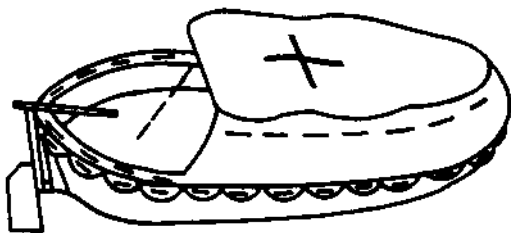

Fig. 7.2-6

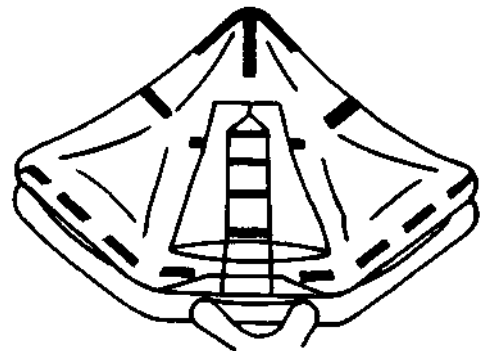











Fig. 7.2-11

APPENDIX 2 <sup>1</sup>

**SYMBOLS FOR USE IN ACCORDANCE WITH REGULATION III/9.2.3  
OF THE 1974 SOLAS CONVENTION, AS AMENDED IN 1983**









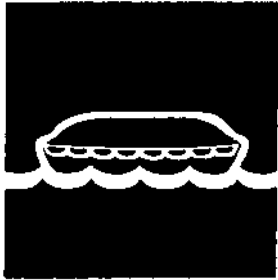

| Ref. <sup>2</sup> | Item                                | Symbol <sup>3</sup>   | Ref. <sup>2</sup> | Item             | Symbol <sup>3</sup>   |
|-------------------|-------------------------------------|---|-------------------|------------------|---|
| 1                 | Fasten seat belts                   |    | 4.3               | the rescue boat  |    |
| 2                 | Secure hatches                      |   | 5                 | Release falls    |   |
| 3                 | Start engine                        |  | 6                 | Start waterspray |  |
| 4<br>4.1          | Lower to the water:<br>the lifeboat |  | 7                 | Start air supply |  |
| 4.2               | the liferaft                        |  | 8                 | Release gripes   |  |

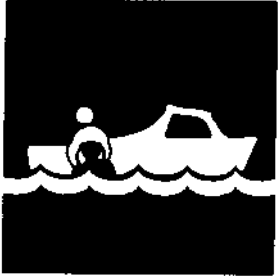
<sup>1</sup> This Appendix is the Appendix to the IMO resolution A. 760(18).

<sup>2</sup> Numbers are used for reference purposes only and do not indicate the sequence of events as this will depend on the type of survival craft and launching appliances provided on board the ship.









<sup>3</sup> All symbols shall be white on a blue background.

**RECOMMENDED SYMBOLS INDICATING THE LOCATION OF EMERGENCY EQUIPMENT AND MUSTER AND EMBARKATION STATIONS IN ACCORDANCE WITH THE 1974 SOLAS CONVENTION, AS AMENDED IN 1983**

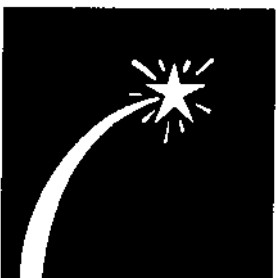
| Ref. <sup>1</sup> | Item                    | Symbol <sup>2</sup>   | Ref. <sup>1</sup> | Item                         | Symbol <sup>2</sup>   |
|-------------------|-------------------------|---|-------------------|------------------------------|---|
| 1                 | Lifeboat                |    | 6a                | Evacuation slide             |    |
|                   |                         |   | 6b                | Evacuation slide             |    |
| 2                 | Rescue boat             |   | 7                 | Lifbuoy                      |   |
| 3                 | Liferaft                |  | 8                 | Lifbuoy with line            |  |
| 4                 | Davit-launched liferaft |  | 9                 | Lifbuoy with light           |  |
| 5                 | Embarkation ladder      |  | 10                | Lifbuoy with light and smoke |  |

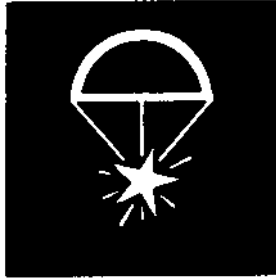
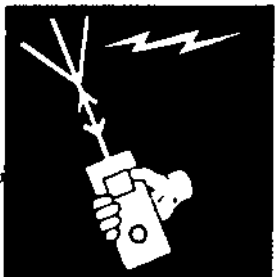

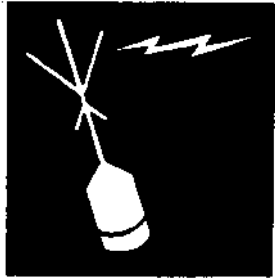



<sup>1</sup> Numbers are used for reference purposes only and do not indicate the sequence of events as this will depend on the type of survival craft and launching appliances provided on board the ship.

<sup>2</sup> All symbols shall be white on a green background. The sizes of signs, letters and numbers shall be to the satisfaction of the flag State Administration. Where appropriate, a white arrow on a green background may be used in conjunction with symbols to indicate direction (see reference 22).

| Ref. <sup>1</sup>  | Item                          | Symbol <sup>2</sup>   | Ref. <sup>1</sup> | Item  | Symbol <sup>2</sup>   |
|--|-------------------------------|---|-------------------|---|---|
| 11   | Lifejacket                    |    | 16                | Radar transponder                           |    |
| 12   | Child's lifejacket            |    | 17                | Survival craft pyrotechnic distress signals |    |
| 13   | Immersion suit                |   | 18                | Rocket parachute flares                     |   |
| 14   | Survival craft portable radio |  | 19                | Line-throwing appliance                     |  |
| 15   | EPIRB                         |  | 20                | Muster station                              |  |
| The station letter shall be included on the right-hand side of the symbol. |                               |   |                   |   |   |

<sup>1</sup> See footnote 1, p. 73.

<sup>2</sup> See footnote 2, p. 73.

| Ref. <sup>1</sup>   | Item  | Symbol <sup>2</sup>  | Ref. <sup>1</sup> | Item              | Symbol <sup>2</sup>  |
|---|---|--|-------------------|-------------------|--|
| 21  | Embarkation station                           |   | 24                | Exit              |   |
| Use appropriate symbol for type of survival craft at the station. The station number shall be included on the right-hand side of the symbol.  |   |  |                   |                   |  |
| 22  | Direction indicator (for use with any symbol) |   | 25                | Emergency exit    |   |
| Insert appropriate symbol (i.e. symbols 1 to 21) on the left-hand side of the arrow. Point arrow in the direction of the equipment or station.  |   |  |                   |                   |  |
| 23  | Emergency exit indicator                      |  | 26                | Baby's lifejacket |  |
| <p><sup>1</sup> See footnote 1, p. 73.</p> <p><sup>2</sup> See footnote 2, p. 73.</p> <p>Notes: 1. The dashed line (see references 20 to 23, 25) indicates that the whole symbol may consist of one part or of two separate parts (one for the sign and another for the number or letter). When a direction indicator (arrow) is also used it may be part of the symbol or be separate. The dashed line shall not be shown.</p> <p>2. Point arrow (see references 20, 22, 23, 25) in the direction of the equipment or station.</p> |   |  |                   |                   |  |



# PART III. SIGNAL MEANS

---

## 1 GENERAL

### 1.1 APPLICATION

**1.1.1** The requirements of the present Part of the Rules applies to the ships whose equipment with signal means is subject to survey by the Register, as well as to items of the said means intended to be fitted in these ships.

**1.1.2** The requirements of the present Part of the Rules applies to ships under construction and to ships in service, and the requirements specified in column 9 of Table 2.2.1, in 4.1.4 and 4.6.2.3 shall be met as far as practicable and reasonable in case of ships in service.

Any ship in service may be exempted from the requirements specified below:

**.1** from repositioning of lights as a result of conversion from Imperial to metric units and rounding off measurement figures;

**.2** from changing of horizontal position of masthead lights on ships of less than 150 m in length, resulting from the prescriptions of 4.2.1.2;

**.3** from repositioning of lights of all-round visibility referred to in 4.1.7.

**1.1.3** The present Part of the Rules establishes technical requirements, the signal means shall comply with, and determines the number of items and their location on board.

### 1.2 DEFINITIONS AND EXPLANATIONS

**1.2.1** The definitions and explanations concerning the general terminology of the Rules are given in Part I "Classification" of Rules for the Classification and Construction of Sea-Going Ships.

For the purpose of the present Part of the Rules the following definitions are adopted.

**Switch-on time** means the period of time required for reaching 95 per cent of the required luminous intensity after the daylight signalling lamp has been switched on.

**Switch off time** means the period of time required for luminous intensity to decrease to 5 per cent of the required luminous intensity after the daylight signalling lamp has been switched off.

**Height above the hull** is the height above the uppermost continuous deck. This height shall be measured from the position vertically beneath the location of the light.

**Length and breadth of ship** are her overall length and greatest breadth.

**Short blast** is a blast of about 1 s duration.

**Prolonged blast** is a blast of 4 to 6 s duration.

**Daylight signalling lamps** mean fixed or portable lamps suitable for transmitting white light signals by focused light beams, which can be clearly distinguished visually as separate signals by an observer.

**Flashing light** is a light flashing at regular intervals at a frequency of 120 flashes or more per minute.

**Whistle** is any sound signalling appliance capable of producing the prescribed short and prolonged blasts.

**Ship engaged in fishing** is a ship fishing with nets, lines, trawls or other fishing apparatus which restrict manoeuvrability; it does not refer to a ship fishing with trolling lines or other fishing apparatus which do not restrict manoeuvrability.

**Ship engaged in trawling** is a ship dragging a dredge net or other trawling fishing gear through the water.

**Ship not under command** is a ship which is unable to keep out of the way of another ship because through some exceptional circumstance she is unable to manoeuvre as required.

**Ship restricted in her ability to manoeuvre** is a ship which from the nature of her work is restricted in her ability to manoeuvre and is therefore unable to keep out of the way of another ship. At least the following ships shall be regarded as ships restricted in their ability to manoeuvre:

a ship engaged in laying, servicing and/or picking up a navigation mark, submarine cable or pipeline;

a ship engaged in dredging, oceanographic, surveying or underwater operations;

a ship engaged in replenishment or transferring persons, provisions or cargo while underway;

a ship engaged in the launching or recovery of aircraft;

a ship engaged in a towing operation such as renders her unable to deviate from her course.

**Ship constrained by her draught** is a power-driven ship which because of her draught in relation to the available depth and width of navigable water is severely restricted in her ability to deviate from the course she is following.

**Power-driven ship** is a ship propelled by machinery.

**Sailing ship** is a ship under sail provided that propelling machinery, if fitted, is not being used.

Hoisted appliance is a device which is lifted to the place of its use.

Stationary appliance is a device which is kept fixed in its regular position.

### 1.3 SCOPE OF SURVEY

**1.3.1** The general provisions relating to the survey procedure for the signal means, as well as requirements for the technical documentation to be submitted to the Register for consideration and directions regarding the documents to be issued by the Register for signal means are outlined in General Regulations for the Classification and Other Activity and in Part I "Survey Regulations".

**1.3.2** The following items are subject to survey by the Register during manufacture:

- .1 navigation lights;
- .2 flashing lights;
- .3 sound signal means;
- .4 pyrotechnic signal means;
- .5 signal shapes;
- .6 radar reflectors.

**1.3.3** The items mentioned in 1.3.2.5 and 1.3.2.6 are subject to survey by the Register only as far as examination and approval of the technical documents are concerned.

**1.3.4** Provision and equipment of ships with signal means shall be carried out under survey by the Register.

**1.3.5** The following technical documents relative to signal means shall be submitted for approval to the Register:

- .1 assembly drawing with specification of component parts and materials;
- .2 technical description;
- .3 program of testing;
- .4 for daylight signalling lamps, instructions for operation with description of ways of checking the parallel adjustment of sighting mechanism and luminous intensity axis.

### 1.4 DIVISION OF SHIPS INTO GROUPS

**1.4.1** All ships, independently of their purpose and area of navigation, are subdivided, according to their equipment with signal means (except for pyrotechnic signal means), into the following two groups:

**.1** Group I including power-driven ships of 20 m in length and more as well as sailing and non-propelled ships of 12 m in length and more.

**.2** Group II including power-driven ships of less than 20 m in length as well as sailing and non-self-propelled ships of less than 12 m in length.

## 2 EQUIPMENT OF SHIPS WITH SIGNAL MEANS

### 2.1 GENERAL

**2.1.1** Signal means considered in the present Part of the Rules include:

- .1 navigation lights;
- .2 flashing lights;
- .3 sound signal means;
- .4 signal shapes;
- .5 pyrotechnic signal means;
- .6 radar reflectors.

**2.1.2** The equipment of lifeboats, rescue boats and liferafts with all kinds of signal means shall meet the requirements of Part II "Life-Saving Appliances".

**2.1.3** The technical requirements for radar reflectors are specified in 3.7.8 and 5.8, Part V "Navigational Equipment".

**2.1.4** Equipment of unmanned objects being towed with sound and pyrotechnic signal means and radar reflectors is not required.

### 2.2 EQUIPMENT OF GROUP I SHIPS

**2.2.1** The basic set of signal means of Group I ships, other than pyrotechnic signal means, shall comply with Table 2.2.1.

Additional signal means for towing or pushing ships, ships restricted in their ability to manoeuvre, pilot, fishing and air cushion ships are given in Table 2.4.1, and the equipment of ships with pyrotechnic signal means shall comply with Table 2.5.1.

**2.2.2** Ships of Group I may be provided with electric or oil navigation lights. If a set of navigation lights comprises electric lights, provision shall be made for an additional set of spare lights, the number of which is given under 2.2.4. The spare set may be either electric or oil lights.

In power-driven ships spare masthead lights, sidelights and stern lights shall be installed in regular positions or duplicated electric lights (navigation lights with two light sources one of which is supplied from the ship's mains and the other from an emergency source of power) shall be used.

Table 2.2.1

## Basic set of signal means for ships of Group I

| Nos | Types of ships  | Navigation lights |                       |                 |                |                  |     | Flashing lights |  | Sound signals |                |  | Signal shapes |  |                      | Radar reflectors                                  |
|-----|---|-------------------|-----------------------|-----------------|----------------|------------------|-----|-----------------|--|---------------|----------------|--|---------------|--|----------------------|---|
|     |   | Mast-head         | Side-light star-board | Side-light port | Stern          | All-round        |     | Manoeuvring     | Daylight signalling lamp   | Whistle       | Bell           | Gong   | Ball          | Cone   | Diamond <sup>1</sup> |   |
|     |   |                   |                       |                 |                | White            | Red |                 |  |               |                |  |               |  |                      |   |
| 1   | Power-driven ships  | 2/1 <sup>2</sup>  | 1                     | 1               | 1              | 2/1 <sup>2</sup> | 2   | 1               | One lamp for every ship of more than 150 gross tonnage, and for passenger ships, irrespective of their gross tonnage | 1             | 1 <sup>3</sup> | One gong for every ship of 100 m in length and more <sup>3</sup> | 3             | One cone for every power-driven ship under sail <sup>4</sup> | 1                    | One for every ship of less than 150 gross tonnage |
| 2   | Sailing ships <sup>5</sup> and also non-self-propelled ships being towed <sup>8</sup> or pushed ahead | —                 | 1 <sup>6</sup>        | 1 <sup>6</sup>  | 1 <sup>7</sup> | 2/1 <sup>2</sup> | 2   | —               | Ditto  | 1             | 1 <sup>3</sup> | Ditto  | 3             | Ditto  | 1 <sup>7</sup>       | Ditto   |

<sup>1</sup> May be replaced by two cones joined at their bases.  
<sup>2</sup> Indicated in the numerator is the number for ships of 50 m in length and more, in the denominator, for ships of less than 50 m in length. Ships of less than 50 m in length may be provided with two lights.  
<sup>3</sup> See 2.2.8.  
<sup>4</sup> Not required if, instead of the diamond (see Note 1), two cones joined at their bases are used.  
<sup>5</sup> See 2.2.6.  
<sup>6</sup> See 2.2.7.  
<sup>7</sup> Not required for ships being pushed ahead.  
<sup>8</sup> Slightly conspicuous, partly submerged ships or objects being towed or combination of such ships and objects shall exhibit: two all-round white lights, if the breadth of the above objects is less than 25 m; four all-round white lights, if the breadth of the above objects is 25 m and more; five all-round white lights, if the length of the tow is 100 m and more; in addition, one diamond shape, if the length of the tow is over 200 m.

Power supply of electric lights shall comply with the requirements of 6.8.2, 9.3.1 and 19.1.2.1, Part XI "Electrical Equipment" of Rules for the Classification and Construction of Sea-Going Ships.

In ships engaged in international voyages and provided with electric generator sets, except for sailing ships, the basic set shall be composed of electric lights.

Ships having a basic set composed of oil lights shall be provided with a spare set of lights, the number of which is given under 2.2.4.

**2.2.3** Oil tankers and other ships intended for carrying petroleum products or other flammable cargoes as well as ships intended for towing and servicing the above ships shall be provided with electric lights only.

**2.2.4** A set of spare lights comprises:

**.1** masthead, side, stern, except for the use of lights as the main duplicated electric lights, white

and red all-round lights ("Ship not under command" signal and anchor);

**.2** all-round white, red and green lights indicating the occupation of the ship (trawling, fishing, pilot), "Ship restricted in her ability to manoeuvre" signal, towing (white) and towing (yellow) lights.

**2.2.5** Every ship shall be provided with the following spare parts and materials for the lights depending on the set of basic and spare navigation lights installed:

**.1** one light filter for each light ("Ship not under command" and "Ship restricted in her ability to manoeuvre" signals, side, towing (yellow), fishing and air-cushion) unless a coloured lens is fitted in the light;

**.2** two electric lamps for each electric light of the basic set;

**.3** six chimneys, provided that all oil lights have chimneys of the same size. If not, two chimneys shall be provided for each light;

.4 one wick for each oil light;

.5 fuel mixture for spare oil lights in a quantity sufficient to ensure burning of the whole set of lights during at least 32 hours.

2.2.6 Sailing ships may, in addition, be equipped with two lights, the upper being red and the lower green. Characteristics of these lights shall conform to those given in item 8 of Table 3.1.2.

2.2.7 In Group I sailing ships of less than 20 m in length the sternlight and sidelights may be replaced by a combined three-colour light.

2.2.8 A bell or gong may be replaced by other devices having similar sound characteristics. In this case, the manual operation of the required signal shall be possible at all times.

2.2.9 A ship constrained by her draught, in addition to the lights required for power-driven ship in Table 2.2.1, may be provided with three red lights having the characteristics specified in item 8 of Table 3.1.2 and also a cylinder (Table 3.4.1).

When a ship is provided with the above lights, they may be used at the same time as the lights of "Ship not under command" signal required by Table 2.2.1.

### 2.3 EQUIPMENT OF GROUP II SHIPS

2.3.1 The basic set of signal means to be provided for ships of Group II, apart from pyrotechnic signal means, shall be in compliance with Table 2.3.1.

Additional signal means for towing or pushing ships, ships restricted in their ability to manoeuvre, pilot, fishing and air-cushion ships are given in

Table 2.4.1. The equipment of ships with pyrotechnic signal means shall comply with Table 2.5.1.

2.3.2 Ships of Group II may use either electric or oil lights. These ships are not required to have a set of spare lights (except for a spare oil anchor light, in case of no emergency source of power on board the ship, as well as the masthead, side and stern lights on board power-driven ships). In power-driven ships spare masthead lights, sidelights and stern lights shall be installed in regular positions or duplicated electric lights (navigation lights with two light sources one of which is supplied from the ship's mains and the other from an emergency source of power) shall be used.

2.3.3 Ships of Group II may carry, in lieu of the sidelights, a combined two-colour light.

In sailing ships of Group II sidelights and a sternlight may be replaced by a combined three-colour light.

2.3.4 The equipment of Group II ships with spare parts and materials for the lights shall comply with the requirements of 2.2.5.

2.3.5 A ship of less than 12 m in length shall not be obliged to carry a whistle or bell, but if she does not, she shall be provided with some other means of making an efficient sound signal.

2.3.6 A power-driven ship of less than 7 m in length whose maximum speed does not exceed 7 knots, in lieu of the masthead light, sidelights and sternlight, may be provided with an all-round (360°) white light. Such ship shall, if practicable, also exhibit sidelights or a combined two-colour light.

2.3.7 A power-driven ship of less than 12 m in length, in lieu of the masthead light and sternlight, may be provided with the light specified in column 7 of Table 2.3.1.

Table 2.3.1

Basic set of signal means for ships of Group II

| Nos | Types of ships   | Navigation lights |                                   |                              |                         |           |                | Sound signals        |                   | Signal shapes |  |                | Radar reflectors |
|-----|--|-------------------|-----------------------------------|------------------------------|-------------------------|-----------|----------------|----------------------|-------------------|---------------|--|----------------|------------------|
|     |  | Masthead          | Sidelight, starboard <sup>1</sup> | Sidelight, port <sup>1</sup> | Sternlight <sup>1</sup> | All-round |                | Whistle <sup>2</sup> | Bell <sup>2</sup> | Ball          | Cone   | Diamond        |                  |
|     |  |                   |                                   |                              |                         | White     | Red            |                      |                   |               |  |                |                  |
| 1   | Power-driven ships <sup>3</sup>  | 1 <sup>4</sup>    | 1                                 | 1                            | 1 <sup>4</sup>          | 1         | 2 <sup>4</sup> | 1                    | —                 | 3             | One cone for every power-driven ship under sails | —              | 1                |
| 2   | Sailing ships <sup>5</sup> and also non-self-propelled ships being towed or pushed ahead | —                 | 1                                 | 1                            | 1 <sup>6</sup>          | 1         | 2 <sup>4</sup> | —                    | —                 | 3             |  | 1 <sup>7</sup> | 1                |

<sup>1</sup> See 2.3.3.

<sup>2</sup> See 2.3.5.

<sup>3</sup> See 2.3.6 and 2.3.7.

<sup>4</sup> Not required for ships of less than 7 m in length whose maximum speed does not exceed 7 knots.

<sup>5</sup> See 2.2.6 taking into account that it does not refer to ships provided with a combined three-colour light according to 2.3.3.

<sup>6</sup> Not required for ships being pushed ahead.

<sup>7</sup> Only for ships being towed. May be replaced by two cones joined at their bases.

**2.4 ADDITIONAL SIGNAL MEANS FOR TOWING  
OR PUSHING SHIPS, SHIPS RESTRICTED IN THEIR  
ABILITY TO MANOEUVRE, PILOT, FISHING  
AND AIR-CUSHION SHIPS**

**2.4.1** Towing or pushing ships, ships restricted in their ability to manoeuvre, pilot, fishing and air-cushion ships shall, in addition to signal means required by Table 2.2.1 or 2.3.1, be provided with signal means according to Table 2.4.1.

**2.4.2** Ships engaged in dredging or underwater operations shall, in addition to the lights required by Table 2.4.1 for ships restricted in their ability to manoeuvre, exhibit two red and two green lights

having the characteristics specified in item 8 of Table 3.1.2 as well as two balls and two diamonds.

**2.4.3** When a pushing ship and a ship being pushed are rigidly connected in a composite unit, they shall be regarded as a power-driven ship and shall be equipped with signal means according to item 1 of Table 2.2.1 or 2.3.1.

**2.5 EQUIPMENT OF SHIPS WITH PYROTECHNIC SIGNAL  
MEANS**

**2.5.1** The equipment of ships with pyrotechnic signal means shall comply with the requirements of Table 2.5.1.

Table 2.4.1

**Additional signal means for towing or pushing ships, ships restricted in their ability to manoeuvre,  
pilot, fishing and air-cushion ships**

| Nos | Types of ships   | Lights           |           |                |       |                |                    | Signal shapes |              |
|-----|--|------------------|-----------|----------------|-------|----------------|--------------------|---------------|--------------|
|     |  | Towing           | All-round |                |       | Towing         | All-round flashing | Cone          | Dia-<br>mond |
|     |  | white            | white     | red            | green | yellow         | yellow             |               |              |
| 1   | Towing or pushing ships  | 2/1 <sup>1</sup> | —         | —              | —     | 1 <sup>2</sup> | —                  | —             | —            |
| 2   | Ships restricted in their ability to manoeuvre <sup>3,4</sup>  | —                | 1         | 2 <sup>5</sup> | —     | —              | —                  | —             | 1            |
| 3   | Pilot ships  | —                | 1         | 1              | —     | —              | —                  | —             | —            |
| 4   | Fishing ships engaged in trawling <sup>6</sup>   | —                | 1         | —              | 1     | —              | —                  | 2             | —            |
| 5   | Fishing ships (except for ships engaged in trawling) with nets or lines extending horizontally in the water not more than 150 m <sup>7</sup> | —                | 1         | 1              | —     | —              | —                  | 2             | —            |
| 6   | Fishing ships (except for ships engaged in trawling) with nets or lines extending horizontally in the water more than 150 m                  | —                | 2         | 1              | —     | —              | —                  | 3             | —            |
| 7   | Air-cushion ships  | —                | —         | —              | —     | —              | 1                  | —             | —            |

<sup>1</sup> Indicated in the numerator are the towing ships of Group I, in the denominator, all pushing and towing ships of Group II; if a ship of Group I is engaged in towing, the length of the tow, measured from the stern of the towing ship to the stern of the last ship towed, being not more than 200 m, she may carry one towing light; if a ship of Group II is engaged in towing and the length of the tow exceeds 200 m, she shall carry two towing lights.

<sup>2</sup> Not required for ships pushing ahead or towing alongside.

<sup>3</sup> See 2.4.2.

<sup>4</sup> Lights and signal shapes are not required if the ship's length is less than 7 m.

<sup>5</sup> May be employed as the lights of "Ship not under command" signal as required in column 8 of Tables 2.2.1 and 2.3.1.

<sup>6</sup> Ships of less than 50 m in length may be additionally provided with a masthead light complying with the requirements of item 1 of Table 3.1.2.

<sup>7</sup> Ships engaged in fishing with purse seine gear in close proximity to other ships shall be equipped with two lights according to the requirements of item 10 of Table 3.1.2.

Table 2.5.1

**Equipment of ships with pyrotechnic signal means**

| Area of navigation                    | Ship's parachute rocket | Sound signal rocket or shell <sup>2</sup> | Distress signal hand flare, red <sup>1,2</sup> | Hand flare, white <sup>1,2</sup> | One-star rocket, green <sup>2</sup> | One-star rocket, red <sup>2</sup> |
|---------------------------------------|-------------------------|---|--|----------------------------------|-------------------------------------|-----------------------------------|
| Unrestricted and Restricted <b>R1</b> | 12                      | 12  | 12   | 12                               | 12                                  | 12                                |
| Restricted <b>R2, R2-RSN, R3-RSN</b>  | 12 <sup>3</sup>         | 6   | 6  | 6                                | 6                                   | 6                                 |
| Restricted <b>R3</b>                  | 12 <sup>3</sup>         | —   | 6  | 3                                | —                                   | —                                 |

<sup>1</sup> It is not permitted to use hand flares in oil tankers and other ships intended to carry petroleum products and continuously operating in oil harbour water areas. Instead of hand flares, such ships may be provided with a 50 per cent greater number of parachute rockets or sound signal shells than that specified in this Table.

<sup>2</sup> Recommended.

<sup>3</sup> Ships not engaged in international voyages shall be provided with not less than six parachute rockets.

## 2.6 BERTH-CONNECTED SHIPS

**2.6.1** A berth-connected ship shall be equipped with all-around white lights:

if the length of the ship is less than 50 m — one light on either side;

if the length of the ship is 50 m and over but less than 100 m — two lights on either side, spaced 50 m apart;

if the length of the ship is 100 m and over, the number of lights shall be such that one light is provided for each 50 m of the ship length. Where

more than two lights are fitted on either side of a berth-connected ship, they shall be equally spaced.

If a berth-connected ship is designed so that she can be moored one side only, all-around lights may be fitted only on the offshore side.

**2.6.2** A berth-connected ship when towed in open seas and waters connected therewith, shall be equipped with side and stern lights.

**2.6.3** A berth-connected ship, when towed through in-land waterways, shall be equipped with lights in accordance with Inland Navigation Rules of the Russian Federation.

## 3 CONSTRUCTION OF SIGNAL MEANS

### 3.1 NAVIGATION LIGHTS

#### 3.1.1 Categories of lights.

This Part of the Rules specifies requirements for three basic categories of navigation lights:

**.1** lights of Category I intended for ships of 50 m in length and more;

**.2** lights of Category II intended for ships of 12 m in length and more but under 50 m;

**.3** lights of Category III intended for ships of less than 12 m in length.

#### 3.1.2 Main characteristics of lights.

Main characteristics of various navigation lights are given in Table 3.1.2.

Table 3.1.2

Main characteristics of navigation lights

| Nos | Lights   | Light colour           | Minimum range of visibility, nautical miles |                       |                        | Arc of visibility in horizontal plane |   |
|-----|--|------------------------|---|-----------------------|------------------------|---------------------------------------|---|
|     |  |                        | Lights of Category I                        | Lights of Category II | Lights of Category III | Total angle, deg                      | Position  |
| 1   | Masthead }<br>Towing }   | White                  | 6   | 5 <sup>1</sup>        | 2                      | 225                                   | 112,5° from right ahead on either side  |
| 2   | Sidelight, starboard   | Green                  | 3   | 2                     | 1                      | 112,5                                 | 112,5° from right ahead on starboard side   |
| 3   | Sidelight, port  | Red                    | 3   | 2                     | 1                      | 112,5                                 | 112,5° from right ahead on port side  |
| 4   | Combined two-colour  | Green<br>Red           | —   | 2                     | 1                      | 225                                   | 112,5° from right ahead on either side: green sector on starboard side, red sector on port side   |
| 5   | Combined three-colour  | Green<br>Red<br>White  | —   | —                     | 1 <sup>2</sup>         | 360                                   | Green sector — 112,5° from right ahead on starboard side; red sector — 112,5° from right ahead on port side; white sector — 135° to 67,5° from right aft on either side |
| 6   | Sternlight   | White                  | 3   | 2                     | 2                      | 135                                   | 67,5° from right aft on either side   |
| 7   | Towing   | Yellow                 | 3   | 2                     | 2                      | 135                                   | 67,5° from right aft on either side   |
| 8   | All-round  | White<br>Red<br>Green  | 3   | 2                     | 2                      | 360                                   | All round the horizon   |
| 9   | All-round flashing   | Yellow                 | 3   | 2                     | 2                      | 360                                   | All round the horizon   |
| 10  | Additional all-round lights for fishing ships engaged in trawling and fishing with purse seine gear in close proximity to other ships <sup>3</sup> | White<br>Red<br>Yellow | 1   | 1                     | 1                      | 360                                   | All round the horizon   |
| 11  | All-round for slightly conspicuous, partly submerged ships or objects being towed  | White                  | 3   | 3                     | 3                      | 360                                   | All round the horizon   |

<sup>1</sup> In ships of less than 20 m in length the minimum range of visibility is 3 nautical miles.

<sup>2</sup> The minimum range of visibility of white sector is 2 nautical miles.

<sup>3</sup> The range of visibility shall be at least 1 nautical mile, but less than that of other all-round lights exhibited by a ship.

### 3.1.3 General technical requirements.

**3.1.3.1** The navigation lights listed in Table 3.1.2 may be fitted with electric or oil source of light (see 3.1.7).

**3.1.3.2** Lights shall be so constructed as to prevent water from getting into contact with current-carrying parts in the electric lights, or with chimney, burner or other parts affecting the operation of the oil lights when such lights are being sprayed with water.

**3.1.3.3** The light shall reliably operate at variations of ambient temperature from  $-30$  to  $+45$  °C. Lights intended for icebreakers of categories **Icebreaker7**, **Icebreaker8**, **Icebreaker9** and ships of ice categories **Arc5** to **Arc9** (see 2.2.3, Part I "Classification" of Rules for the Classification and Construction of Sea-Going Ships) shall be adapted to operate at a negative temperature down to  $-40$  °C.

**3.1.3.4** The lights shall be reliable in operation under vibration and shaking such as may occur in the ship, at a trim of not less than  $10^\circ$  and periodic heeling up to  $45^\circ$ .

**3.1.3.5** Oil lights shall be so constructed as to ensure burning under a wind velocity of up to 30 m/s.

**3.1.3.6** The electric navigation lights shall maintain lighting characteristics under variations from the rated supply voltage for long periods as specified in 2.1.3.1, Part XI "Electrical Equipment" of Rules for the Classification and Construction of Sea-Going Ships.

### 3.1.4 Light case.

**3.1.4.1** The light case and its parts shall be manufactured of materials resistant to sea water, or materials with an adequate anticorrosive protective coating. The electric light shall be of watertight design (IP 56).

**3.1.4.2** The electric and oil lights shall be so constructed as to prevent such heating of the optical parts and of the light case which would result in damage to optical parts or deformation of the case, owing to temperature variations which may be encountered in any climatic conditions.

**3.1.4.3** The light case shall be of such a design as to allow rapid change of electric or oil lamps. Oil lights shall be so constructed as to enable a lamp with its chimney fitted to be inserted into them.

**3.1.4.4** The lights shall be of such a design as to ensure drainage of condensate and fresh air inflow to the extent related to the required degree of protection.

**3.1.4.5** The cases of basic and spare lights shall be so constructed as to provide for their efficient securing in the working position as well as rapid removal and fitting in the regular places.

Lights of all-round visibility ( $360^\circ$ ) in a horizontal plane, which are hoisted one above the other, shall be fitted with handles for hoisting.

### 3.1.5 Lenses and plain glasses.

**3.1.5.1** The navigation lights may be fitted with lenses or plain glasses provided the minimum range of visibility meets the requirements specified in Table 3.1.2 and the curve of vertical light distribution of the light — requirements of 3.1.5.3.

**3.1.5.2** The inner and outer surfaces of the lenses and plain glasses shall be smooth, and the glass shall be free from foreign inclusions, blisters and chippings impairing the light characteristics.

**3.1.5.3** The lenses of the electric navigation lights shall be of such a design that the curve of vertical light distribution of the light will ensure:

**1** luminous intensity not less than that prescribed in 3.1.7.1 within the range of visibility in vertical plane up to  $5^\circ$  on either side from the horizontal plane of symmetry of the lens;

**2** not less than 60 per cent of the prescribed luminous intensity within the range of visibility up to  $7,5^\circ$  on either side from the horizontal plane of symmetry of the lens; and for lights of sailing ships under way, not less than 50 per cent of the prescribed luminous intensity within the range of visibility up to  $25^\circ$  on either side from the horizontal plane of symmetry of the lens.

**3.1.5.4** The curve of horizontal light distribution of the sidelights shall be such that lights fitted in the ship have the luminous intensity from right ahead, as prescribed in 3.1.7.1. The intensity shall decrease and disappear between  $1$  and  $3^\circ$  outside the prescribed sectors.

For sternlights and masthead lights and also at  $22,5^\circ$  abaft the beam for sidelights, the specified luminous intensity shall be maintained up to  $5^\circ$  within the limits of sectors prescribed in Table 3.1.2. From  $5^\circ$  within the prescribed sectors the intensity may decrease by 50 per cent up to the prescribed limits; then it shall decrease steadily to reach practical cut-off at not more than  $5^\circ$  outside the prescribed limits.

### 3.1.6 Coloured light filters.

**3.1.6.1** The colouring of the navigation lights may be obtained with the use of appropriate light filters or coloured lenses. Plain coloured glasses may be used provided that the chromaticity of the filter is ensured over their whole surface.

The use of coloured lenses is subject to special consideration by the Register in each case.

**3.1.6.2** The coloured light filters used in the navigation lights may be manufactured of glass coloured throughout its entire thickness or over the surface only (cover plates).

The light filters may be manufactured of plastics provided all their characteristics are in all cases not inferior to those of the glass filters.

**3.1.6.3** Corner coordinates  $x$ ,  $y$  of the allowable zones for each colour are given in Table 3.1.6.3.

Table 3.1.6.3

Corner coordinates of chromaticity zones

| Light colour | Coordinates | Points |       |       |       |       |       |
|--------------|-------------|--------|-------|-------|-------|-------|-------|
|              |             | 1      | 2     | 3     | 4     | 5     | 6     |
| Red          | <i>x</i>    | 0,680  | 0,660 | 0,735 | 0,721 | —     | —     |
|              | <i>y</i>    | 0,320  | 0,320 | 0,265 | 0,259 | —     | —     |
| Green        | <i>x</i>    | 0,028  | 0,009 | 0,300 | 0,203 | —     | —     |
|              | <i>y</i>    | 0,385  | 0,723 | 0,511 | 0,356 | —     | —     |
| White        | <i>x</i>    | 0,525  | 0,525 | 0,452 | 0,310 | 0,310 | 0,443 |
|              | <i>y</i>    | 0,382  | 0,440 | 0,440 | 0,348 | 0,283 | 0,382 |
| Yellow       | <i>x</i>    | 0,612  | 0,618 | 0,575 | 0,575 | —     | —     |
|              | <i>y</i>    | 0,382  | 0,382 | 0,425 | 0,406 | —     | —     |

Here the colour of light is considered as a result obtained in the light filter — source of light optical system.

The luminous transmissivity of the coloured light filters shall have such values as to ensure the specified range of visibility of the lights according to Table 3.1.2 and to the requirements of 3.1.5.3.

**3.1.6.4** The height and the length of the arc of a coloured light filter shall be such as to cover the whole inside surface of the lens.

**3.1.6.5** The inner and outer surfaces of the light filters shall be free from notches and indentations, and the filter glass shall be free from blisters, foreign inclusions and drops which impair the characteristics of the lights.

**3.1.6.6** The light filters shall be fixed in the lights in such a way as to preclude their spontaneous shifting in the course of their use on board the ship.

**3.1.6.7** The fastening arrangements of the light filters in the side and combined two-colour and three-colour navigation lights shall be so constructed as to prevent the possibility of placing the red filter instead of the green one, and vice versa.

### 3.1.7 Sources of light.

**3.1.7.1** The source of light in the electric lights shall be an electric lamp, and in the oil lights — an oil lamp. For the range of visibility required by Table 3.1.2, the luminous intensity *I*, in cd, of the electric light shall not be less than that determined by the following formula:

$$I = 3,43 \cdot 10^6 T D^2 k^{-D} \quad (3.1.7.1)$$

where  $T = 2 \cdot 10^{-7}$  — threshold factor, in lux;  
*D* = range of visibility of the light, in nautical miles;  
*k* = 0,8 — atmospheric transmissivity corresponding to meteorological visibility of approximately 13 nautical miles.

The luminous intensity determined by the Formula (3.1.7.1) is given in Table 3.1.7.1.

Maximum allowable luminous intensity of lights may be up to 1,7 times the values given in

Table 3.1.7.1

Luminous intensity of light

| Range of visibility<br><i>D</i> , nautical miles         | 1   | 2   | 3  | 4  | 5  | 6  |
|--|-----|-----|----|----|----|----|
| Luminous intensity of light <i>I</i> , cd, for $k = 0,8$ | 0,9 | 4,3 | 12 | 27 | 52 | 94 |

Table 3.1.7.1, but shall not exceed 150 cd. It shall not be achieved by regulation of luminous intensity.

For non-electric lights, the luminous intensity shall correspond to that determined by the formula, to a maximum possible degree.

**3.1.7.2** The sources of light shall be fitted in the lights in a vertical position, so that the horizontal plane of symmetry of the lens shall divide the luminous part of the light source into two nearly equal parts.

**3.1.7.3** The fixing arrangement for the source of light in the light shall be so constructed as to permit the placing of this in only one fixed position, so that no spontaneous change in this position can occur during the use of the light on board the ship, and suitable provisions shall be made for ready replacement of the source of light in the light.

**3.1.7.4** Electric lights shall be fitted with sockets and marine type lamps having devices for prevention of their spontaneous loosening.

**3.1.7.5** The use in the electric lights, except for twin lights, of more than one lamp or of one two-filament lamp (one filament being for permanent service and the other for emergency use) is not permitted.

**3.1.7.6** Burners used in the oil lights may be with a signal flat wick, with two flat wicks or with a round wick. The burners and wicks shall have such dimensions as to ensure the luminous intensity of the light specified in 3.1.7.1.

**3.1.7.7** The wicks shall be of such a quality as to form minimum carbon deposit and to ensure an equal luminous intensity when burning during not less than 6 hours without trimming the wick and the carbon removal.



**3.1.7.8** Oil cistern in the oil light shall be so constructed and fitted as to secure its immobility and to prevent the lamp from being placed in a wrong way.

The cistern capacity, irrespective of the purpose of the light, shall be such that burning of the lamp is maintained during not less than 16 hours.

**3.1.7.9** The fuel to be used in the oil lights is a mixture with a radiation temperature of not less than 1900 °K.

**3.1.7.10** The lamp chimney shall be made of a colourless glass having as few foreign inclusions, blisters and indents as possible, which, if present, shall not reduce the luminous intensity of the lights, specified in 3.1.7.1.

**3.1.7.11** Reflectors in masthead, side or stern oil lights shall be manufactured of corrosion-resistant material and be of such a design and dimensions as to ensure the proper direction of reflected rays falling onto the lens. The reflector shall be so placed in the light that its curvature centre coincides with the optical centre of the lens.

The application of reflectors in electric navigation lights is not permitted.

## 3.2 FLASHING LIGHTS

### 3.2.1 Manoeuvring lights.

**3.2.1.1** Manoeuvring lights shall be all-round white ones. The range of visibility shall be not less than 5 nautical miles.

**3.2.1.2** Materials and construction of manoeuvring lights shall comply with the relevant requirements, and the horizontal luminous intensity of one flash shall not be less than:

$$I_f = \frac{0,2 + t_f}{t_f} I \quad (3.2.1.2)$$

where  $t_f$  = flash duration, in s;  
 $I$  = luminous intensity according to 3.1.7.1, in cd.

**3.2.1.3** The manoeuvring light shall be an electric one and shall send flashing light signals whilst the manoeuvre is being carried out. The duration of each flash and the interval between flashes shall be about 1 s, and the interval between successive signals shall not be less than 10 s.

### 3.2.2 Daylight signalling lamps.

**3.2.2.1** The main characteristics of daylight signalling lamps shall comply with the following requirements:

**.1** by day and with an atmospheric transmission of 0,8, the visibility of light signals emitted by daylight signalling lamps shall be at least 2 nautical miles, equalling a required luminous intensity of 60000 cd;

**.2** the axial luminous intensity of daylight signalling lamps shall reach at least 90 per cent of the maximum luminous intensity;

**.3** the luminous intensity of daylight signalling lamps shall have its maximum in the centre of the luminous intensity distribution. It shall decrease evenly from the centre of luminous intensity distribution;

**.4** the half angle of divergence  $\alpha_h$  shall not exceed 9°, the tenth angle of divergence  $\alpha_z$  shall not exceed 14°;

**.5** the chromaticity of the white signal light shall lie within the corner coordinates, as specified in Table 3.1.6.3;

**.6** the effective light emission sectors of daylight signalling lamps shall be circular. The sum of switch-on and switch-off times shall not exceed 500 ms;

**.7** daylight signalling lamps shall be provided with an indication of their operational status;

**.8** daylight signalling lamps and any battery required for operation shall be designed in such a way that safe handling in the intended application is ensured. The daylight signalling lamp shall be capable of being operated by personnel wearing gloves.

**3.2.2.2** Daylight signalling lamps shall comply with the following technical requirements:

**.1** the illuminant shall be safely fitted in the daylight signalling lamp; use of screwed sockets shall be avoided;

**.2** daylight signalling lamps shall be designed in such a way that the illuminant can be easily replaced also in the dark;

**.3** the sighting mechanism shall be mounted in a fixed attitude, parallel to the optical axis;

**.4** all parts of daylight signalling lamps shall be made of anti-magnetic material;

**.5** daylight signalling lamps shall be so constructed that the accumulation of condensed water is avoided;

**.6** the materials used shall withstand heat generation during operation;

**.7** daylight signalling lamps shall be resistant to environmental conditions;

**.8** each daylight signalling lamp shall be provided with at least three spare illuminants complying with the type-tested illuminant;

**.9** the outer parts of daylight signalling lamps shall not reach temperatures during operation, which restrict their manual use;

**.10** where applicable, daylight signalling lamps shall be protected against short circuit to prevent damage to the lamp or injury to the operator.

**3.2.2.3** The power supply shall comply with the following requirements:

**.1** operation of the daylight signalling lamps shall not be solely dependent upon the ship's main or emergency sources of electrical power;

.2 daylight signalling lamps shall be provided with a portable battery with a complete weight of not more than 7,5 kg;

.3 the portable battery shall have sufficient capacity to operate the daylight signalling lamp for a period of not less than 2 h;

.4 daylight signalling lamps shall continue to operate satisfactorily in the presence of variations of power supply normally to be expected in a ship;

.5 means shall be incorporated for the protection from the effects of excessive current and voltage, transients and accidental reversal of the power supply polarity;

.6 if provision is made for operating daylight signalling lamps from more than one source of electrical power, arrangements for rapidly changing from one source to the other shall be provided but not necessarily incorporated in the equipment;

.7 daylight signalling lamps shall be reliable in operation, as specified in 5.1.41, Part IV "Radio Equipment".

#### 3.2.2.4 Marking and identification.

3.2.2.4.1 Daylight signalling lamps shall be marked clearly and durably with the following data:

identification of the manufacturer;

equipment type number or model identification under which it was type tested;

serial number of the unit.

3.2.2.4.2 On the illuminant, the manufacturer's label and the voltage and power consumption shall be marked clearly and durably.

### 3.3 SOUND SIGNAL MEANS

3.3.1 Main characteristics of whistles shall be in accordance with Table 3.3.1.

The fundamental frequency of the signal shall lie within the range 70 to 700 Hz. The range of audibility of the signal from a whistle shall be determined by

those frequencies, which may include the fundamental and/or one or more higher frequencies within the range 180 to 700 Hz ( $\pm 1$  per cent) for ships of 20 m and more in length, and within 180 to 2100 Hz ( $\pm 1$  per cent) for ships less than 20 m in length, which provide the sound pressure levels specified in Table 3.3.1.

3.3.2 A bell and gong shall produce a sound pressure level of not less than 110 dB at 1 m.

3.3.3 The sound signals of the ship shall be reliable in operation and shall produce the required sound intensity, duration and clear sounding of each blast.

3.3.4 The sound made on a whistle shall be of even tone with no vibration, hissing or other distortions. The beginning and the end of each signal, no matter how long it may sound, shall be distinct and abrupt.

The whistle shall be so designed that compliance with the requirements of 4.6.2.1 is ensured.

For sounding on the whistle in fog it is recommended to provide for special automatic controls ensuring time regulation of signal sounding and also to provide for possible manual actuation of signals with automatic cutting-off of the automatic controls at the moment of manual actuation.

3.3.5 The bell shall give a loud and clear sound and be manufactured of material not requiring protection against corrosion. No painting of the bell is permitted.

The bell intended for ships of 20 m in length and more shall have an outer diameter at the bell mouth of not less than 300 mm. The mass of the striker shall not be less than 3 per cent of the mass of the bell.

3.3.6 The gong shall be manufactured of steel, bronze or other equivalent material.

The gong shall be provided with a beetle and a device for its suspension on the stanchion or holding in hands if it is of portable type.

A steel gong shall have anticorrosive coating. Painting of the gong is not permitted.

3.3.7 Power supply of electric drives of sound signal means and control means thereof shall be

Table 3.3.1

Main characteristics of whistles

| Length of ship, m | Range of fundamental frequencies, Hz | 1/3 <sup>1</sup> -octave band level at 1 metre, dB, referred to $2 \times 10^{-5}$ N/m <sup>2</sup> | Audibility range, nautical miles <sup>2</sup> |
|-------------------|--------------------------------------|---|---|
| $L \geq 200$      | 70 — 200                             | 143   | 2,0   |
| $75 \leq L < 200$ | 130 — 350                            | 138   | 1,5   |
| $20 \leq L < 75$  | 250 — 700                            | 130   | 1,0   |
| $L < 20$          | 180—450                              | 120   | 0,5   |
| $L < 20$          | 450—800                              | 115   | 0,5   |
| $L < 20$          | 800—2100                             | 111   | 0,5   |

<sup>1</sup> A whistle fitted in a ship shall provide in the direction of the maximum intensity of the whistle and at a distance of 1 m from it a sound pressure level, in at least 1/3-octave band within the range of frequencies 180 to 700 Hz ( $\pm 1$  per cent) for ships of 20 m and more in length, and within 180 to 2100 Hz ( $\pm 1$  per cent) for ships less than 20 m in length, of not less than the appropriate value given in the Table.

<sup>2</sup> The range of audibility given above is for information and is approximately the range at which a whistle may be heard on its forward axis with 90 per cent probability in conditions of still air on board a ship having average background noise level at the listening posts (taken to be 68 dB in the octave band centred on 250 Hz and 63 dB in the octave band centred on 500 Hz).

provided from the main and emergency sources of power in compliance with 4.3, 9.3.1 and 19.1.2.1, Part XI "Electrical Equipment" of Rules for the Classification and Construction of Sea-Going Ships.

### 3.4 SIGNAL SHAPES

**3.4.1** The signal shapes shall be of black colour and shall have the dimensions not below those specified in Table 3.4.1.

Table 3.4.1

Dimensions of signal shapes

| Nos | Signal shape | Dimensions, in m, for ships                  |  |
|-----|--------------|--|--|
|     |              | of 20 m in length and more                   | of less than 20 m in length                  |
| 1   | Ball         | 0,6 in diameter                              | 0,3 in diameter                              |
| 2   | Cone         | Base diameter and height 0,6                 | Base diameter and height 0,3                 |
| 3   | Diamond      | Smaller diagonal 0,6<br>Greater diagonal 1,2 | Smaller diagonal 0,3<br>Greater diagonal 0,6 |
| 4   | Cylinder     | 0,6 in diameter and 1,2 in height            | —  |

**3.4.2** The signal shapes shall be provided with suitable devices for fixing them to halyards on which they are hoisted, and for joining with other shapes.

Folding shapes shall be fitted with the devices retaining them in open position and preventing the shapes from spontaneous folding.

Devices for joining the shapes one to another (except the cones) shall provide for maintaining the proper distance between them, which shall not be less than 1,5 m for ships of 20 m in length and more and not to be less than 1 m for ships of less than 20 m in length.

The cones shall be provided with devices for joining them directly one to another with their points or bases together.

### 3.5 PYROTECHNIC SIGNAL MEANS

#### 3.5.1 General.

Pyrotechnic signal means shall have the characteristics specified in Table 3.5.1 and meet the following requirements:

**.1** not to be damaged in stowage throughout the air temperature range  $-30^{\circ}\text{C}$  to  $+65^{\circ}\text{C}$ ;

**.2** to be contained in a water-resistant casing not subject to corrosion;

**.3** to be indelibly marked with brief instructions or diagrams clearly illustrating how it shall be operated;

**.4** if hand operated, to be operated from bottom or to contain an operational safety delay of 2 s;

**.5** to have a simple means of ignition which requires the minimum of preparation and can be readily operated in adverse conditions without external aid and with wet, cold or gloved hands;

**.6** to have integral means of ignition (for rocket parachute flares and hand flares);

**.7** to be indelibly marked with means for determining its age;

**.8** the packing of pyrotechnic signal means shall allow the marking to be visible on the pyrotechnic device itself. Otherwise, the marking complying with the requirements of 3.5.1.7 shall be positioned on the packing as well.

**3.5.2** The rocket parachute flares, hand flares and buoyant smoke signals shall comply with the requirements of 6.7, Part II "Life-Saving Appliances".

Table 3.5.1

Characteristics of pyrotechnic signal means

| Nos | Pyrotechnic signal means        | Light colour | Luminous intensity <sup>1</sup><br>(minimum), cd | Altitude<br>(minimum), m | Range<br>of audibility <sup>2</sup><br>(minimum),<br>nautical miles | Burning time<br>(minimum), s | Purpose                         |
|-----|---------------------------------|--------------|--|--------------------------|---|------------------------------|---------------------------------|
| 1   | Rocket parachute flare (marine) | Red          | 30000  | 300                      | —   | 40                           | To be used as a distress signal |
| 2   | Sound signal rocket or shell    | —            | —  | —                        | 5   | —                            | Ditto                           |
| 3   | Hand flare                      | Red          | 15000  | —                        | —   | 60                           | Ditto                           |
| 4   | Hand flare                      | White        | 10000  | —                        | —   | 20                           | To attract attention            |
| 5   | One-star rocket                 | Green        | 3000   | 80                       | —   | 6                            | Life-saving signals             |
| 6   | One-star rocket                 | Red          | 3000   | 80                       | —   | 6                            | Ditto                           |
| 7   | Buoyant smoke signal            | Orange       | —  | —                        | —   | 180                          | To be used as a distress signal |

<sup>1</sup> To be determined in laboratory conditions.  
<sup>2</sup> To be determined over sea surface at wind force up to 1 and clear atmosphere and at background noise of at least 45 dB.

## 4 FITTING OF SIGNAL MEANS ON BOARD

### 4.1 GENERAL

**4.1.1** The signal means shall be fitted or stored on board in such a manner as to be at all times ready for use.

**4.1.2** The basic and spare sets of lights shall be placed on board in regular positions provided for them.

**4.1.3** In placing the lights the vertical distances between them, specified in this Section, shall be deemed to be minimum. They shall be increased accordingly where some superstructures or hull fittings may obstruct the visibility of the lights. However, the increase of these distances shall not exceed the values set up in this Section.

**4.1.4** In ships equipped with electric navigation lights supplied in accordance with 6.8.2, Part XI "Electrical Equipment" of Rules for the Classification and Construction of Sea-Going Ships, provision shall be made in the wheelhouse for indication on switching of navigation lights and visual and sound alarms warning of a light failure.

In ships less than 50 m in length and in non-self-propelled ships, visual and sound alarms may not be provided if position of navigation lights is such that they are visible from the steering control station or, where there is no such station, from the watch-keeping position.

**4.1.5** The placing of the electric signal means and protection of radio equipment from electrical interference produced by them shall comply with the requirements of 2.2, Part XI "Electrical Equipment" of Rules for the Classification and Construction of Sea-Going Ships.

**4.1.6** In floating cranes and similar ships where it is impracticable to fulfil all the requirements of this Chapter due to particular construction of deck equipment, on agreement with the Register, a different positioning of navigation lights may be accepted which shall, however, be as close as possible to the requirements laid down below.

**4.1.7** Lights of all-round visibility (360°) in horizontal plane, except for anchor lights, shall be so located as not to be obscured by masts, topmasts or superstructures within sectors of more than 6°.

In this case, the light shall be considered as an all-round source of light with the diameter equal to the outside diameter of the source of light (filament of the lamp, flame of the burner).

**4.1.8** When fulfilment of the requirements of 4.1.7 by means of fitting of one all-round light is not feasible, two all-round lights shall be installed. They shall be located or provided with shields in such a

way as to be visible, as far as practicable, as one all-round light at a distance of 1 mile and over. All-round lights shall be screened by these shields less than 180°.

**4.1.9** When two or three lights shall be carried in a vertical line one over the other, they shall be spaced as follows:

**.1** on a ship of 20 m in length and more such lights shall be spaced not less than 2 m apart, and the lowest of these lights shall, except where a towing (yellow) light is required, not be less than 4 m above the hull;

**.2** on a ship of less than 20 m in length such lights shall be spaced not less than 1 m apart, and the lowest of these lights shall, except where a towing (yellow) light is required, not be less than 2 m above the gunwale;

**.3** when three lights are carried, they shall be equally spaced;

**.4** the lower of the two all-round lights prescribed for a ship engaged in fishing shall be at a height above the sidelights not less than twice the distance between the two all-round vertical lights.

### 4.2 MAIN NAVIGATION LIGHTS IN SHIPS OF GROUP I

#### 4.2.1 Masthead lights.

**4.2.1.1** The forward masthead light shall be placed on or in front of the foremast, or if a ship is without a foremast, then in the fore part of the ship in a line with and over the keel at a height above the hull of not less than 6 m.

If the breadth of the ship exceeds 6 m, then this light shall be placed at a height above the hull not less than such breadth, however, not at a greater height above the hull than 12 m.

**4.2.1.2** The after masthead light shall be placed in the fore and aft centreline of the ship.

The vertical distance between the forward and after masthead lights shall not be less than 4,5 m and, also under all normal conditions of trim the after light shall be seen over and separate from the forward light at a distance of 1000 m from the stem when viewed from sea level.

The horizontal separation of forward and after masthead lights shall not be less than one half of the length of the ship, but need not be more than 100 m. The forward masthead light shall not be more than one quarter of the length of the ship from the stem.

If a ship of less than 50 m in length carries only one masthead light, it shall be placed at the height specified in 4.2.1.1.

**4.2.1.3** The masthead lights shall be placed above all other lights except for the lights specified in 4.5.2 and, in exceptional cases, in 4.4.5.1 and 4.4.8, and also above the obstructing superstructures so that each of them is distinctly visible over the arcs of the horizon assigned to them.

**4.2.1.4** Oil masthead lights shall be fitted with suitable devices for hoisting the light to its regular position and for lowering it onto the deck. Such device shall be so constructed as to ensure the correct and stable position of the light when hoisted to its regular position.

**4.2.1.5** Horizontal screens of a sufficient size shall be installed under the masthead lights so as to prevent these lights from illuminating the navigating bridge and other decks.

**4.2.1.6** If only one masthead light is prescribed for a power-driven ship, this light shall be placed to the bow from the midship.

**4.2.1.7** The masthead light of the high-speed ship with length to breadth ratio of less than 3,0 may be placed at a height of less than the height specified in 4.2.1.1, provided the angles at the base of the isosceles triangle which is visible from the side of the end and formed by the sidelights and masthead light are at least 27°.

#### **4.2.2 Sidelights.**

**4.2.2.1** A light containing a green light shall be carried on the starboard side, another one containing a red light shall be carried on the port side, both lights being placed in parallel, in one line perpendicular to, and at the same distance from, the centreline of the ship.

In power-driven ships which carry two masthead lights the sidelights shall be placed abaft the forward masthead light and above the hull at a height of not greater than three quarters of the height of the forward masthead light, their positions being chosen so that the lights of sidelights are not mixed with deck lights and so as to most prevent the lights from being flooded with water.

On power-driven ships the sidelights shall be placed at a distance of not more than 10 % of the breadth of the vessel inboard from the side plating, up to a maximum of 2 m. Where application of above requirement is impracticable (e. g. small ships with superstructure of reduced width) exemption may be given on the basis of a special agreement with the Register.

If a ship carries one masthead light, sidelights may be placed in front of it.

When due to constructional features it is not possible to locate the sidelights on the navigating bridge wings, they shall be fitted on the other deck of the ship in compliance with the other relevant requirements of 4.2.2, on agreement with the Register.

**4.2.2.2** The sidelights shall be protected by inboard shields with two transverse screens (fore and aft) perpendicular to the shield.

The breadth of the fore and aft transverse screens shall be such that the light would practically fade within 1° to 3° beyond the sectors stipulated under items 2 and 3 of Table 3.1.2. In the forward direction, the minimal distance of the light visibility shall be ensured, as required in Table 3.1.2.

It is recommended that shields of such a length shall be fitted that the distance from the outer edge of the light lens or plain glass to the after edge of the fore transverse screen will be 0,9 m at least, and that the breadth of the forward transverse screen shall be chosen such that a line connecting its outer edge to the inner edge of the filament or the light burner will be parallel to the ship centreline.

The height of the shield and of the screens shall not be less than that of the light case.

The shields shall be painted matt black on the inside.

**4.2.2.3** The shields of the sidelights shall be placed in such a position that their outer edge will not project beyond the line of the side of the ship.

The sidelight shall be firmly secured on the shield.

The sidelight shields shall not generally be secured to the standing rigging of the ship. Such arrangement may be permitted only in sailing and sailing motor ships provided the above requirements are met and nothing, the sails including, obstructs the visibility of the lights within their respective arcs of visibility.

**4.2.2.4** When sidelights of inboard retractable type are used, there shall be provided a suitable device to positively lock the lights in their correct working position.

**4.2.2.5** In lieu of the shields, it is permitted to use side walls of the bridge or wheelhouse provided all other requirements set forth in 4.2.2.1 to 4.2.2.4 are met.

**4.2.2.6** Ships being pushed ahead shall carry sidelights fixed in the fore part of the hull.

When installing electric lights, provision shall be made for structural means enabling during operation to take account of the following:

**.1** when a number of ships is being pushed as a group, the sidelights shall only be lighted in the leading ship;

**.2** when a number of ships is being pushed as a group consisting of coupled ships, each of the leading ships being pushed ahead shall be lighted with one sidelight only, i.e. the ship on the extreme right shall exhibit a starboard sidelight and the ship on the extreme left, a port sidelight.

#### **4.2.3 Sternlight.**

A sternlight shall be carried as near as possible to the stern and the centreline of the ship, on agreement with the Register.

Towing ships may carry a sternlight fixed on the funnel at a level higher than the towing arrangement but, if possible, not higher than the sidelights.

#### **4.2.4 All-round white light.**

**4.2.4.1** All-round white lights shall be fixed in the fore and after parts of the ship. The stern all-round white light shall be placed not less than 4,5 m lower than the same forward light. In ships of 50 m in length and more the forward all-round white light shall be carried at a height of not less than 6 m above the hull.

**4.2.4.2** Ships of less than 50 m in length may, in lieu of the lights prescribed in 4.2.4.1, carry one all-round white light where it can best be seen. Such ships shall not be required to carry a stern all-round white light but they may do so, and in case such ships carry two all-round white lights, they shall be fixed as prescribed in 4.2.4.1.

**4.2.4.3** The all-round white lights may be either of stationary type fixed on special stanchions, or they may be hoisted to their regular position by means of a hoisting device. The all-round white lights shall be carried at the ends of the ship in a position where they can best be seen.

#### **4.2.5 Lights of "Ship not under command" signal.**

Two all-round red lights shall be fixed in a stationary position or shall be fitted with suitable device for hoisting in a position where they can best be seen, vertically one below the other in accordance with the requirements of 4.1.7 and 4.1.9.

When fulfilling these requirements, lights of red colour specified in 4.4.5 may be used as the lights of this signal, in this case the all-round white light of the "Restricted Ability to Manoeuvre" signal shall be switched on independently from the all-round red lights of this signal.

### **4.3 MAIN NAVIGATION LIGHTS IN SHIPS OF GROUP II**

#### **4.3.1 Masthead light.**

**4.3.1.1** On a power-driven ship of 12 m in length and more the masthead light need not be placed to the bow from the midship, however it shall be placed as far in the bow as is practicable.

The masthead light shall be fitted in accordance with the requirements of 4.2.1.3, 4.2.1.4 and 4.2.1.5.

**4.3.1.2** Power-driven ships of less than 12 m in length may carry the masthead light or a light as prescribed in 2.3.7 at a height less than 2,5 m above the gunwale, but not less than 1 m above the sidelights or the combined two-colour light.

The masthead or all-round white light may be displaced from the fore and aft centreline of the ship when its centreline arrangement is impracticable provided that the sidelights are combined in one light which shall be located in the fore and aft centreline or

as near as possible to the fore and aft arrangement of the masthead or all-round white light.

#### **4.3.2 Sidelights.**

**4.3.2.1** Installation of the sidelights and their shields shall comply with the requirements of 4.2.2.1 to 4.2.2.5. It is not required that these lights be installed behind the masthead light at a distance approximating to the breadth of the ship. The shield length may be reduced so that the distance from the outer edge of the plain glass or lens to the rear edge of the forward transverse screen is not less than 0,6 m.

**4.3.2.2** If the ships of Group II carry, instead of sidelights, a combined two-colour light, it shall be placed in the centreline of the ship not less than 1 m below the masthead light (see 4.3.1.2) and in such a position as to show its green light from right ahead to 22,5° abaft the beam on starboard side and its red light from right ahead to 22,5° abaft the beam on the port side.

With a combined light using a single vertical filament and a very narrow division between the green and red sectors, external screens need not be fitted.

**4.3.2.3** When a sailing ship is provided with a combined three-colour light (see 2.3.3), it shall be exhibited at or near the top of the mast, where it can best be seen. In other respects, the combined three-colour light shall be fixed in the same manner as specified for the combined two-colour light in 4.3.2.2.

#### **4.3.3 Sternlight.**

The sternlight shall be fixed so as to comply with the requirements of 4.2.3. For installation of the combined three-colour light instead of the stern and sidelights, see 4.3.2.3.

#### **4.3.4 All-round white light.**

The all-round white light shall be placed in compliance with the requirements of 4.2.4.2 and 4.3.1.2.

#### **4.3.5 Light of "Ship not under command" signal.**

Two all-round red lights shall be fixed so as to comply with the requirements of 4.2.5.

### **4.4 ADDITIONAL LIGHTS IN TOWING OR PUSHING SHIPS, FISHING AND PILOT SHIPS, SHIPS RESTRICTED IN THEIR ABILITY TO MANOEUVRE AND AIR-CUSHION SHIPS**

#### **4.4.1 Towing (white) and towing (yellow) lights.**

**4.4.1.1** Ships of Group I engaged in towing another ships shall carry on the fore or after mast three lights, one of which shall at the same time fulfil the function of the forward or after masthead light and two others having the same characteristics (see item 1 of Table 3.1.2) shall be placed above and/or below the forward or after masthead light in a vertical line one over the other and separated by a distance prescribed in 4.1.9.1.

In other respects, the towing (white) lights shall be fixed in the same manner as specified for the masthead lights in 4.2.1 and it shall be borne in mind that when three towing (white) lights are placed on the after mast, the lowest light shall be at least 4,5 m vertically higher than the forward masthead light.

**4.4.1.2** Ships engaged in pushing another ships shall carry on the foremast two towing (white) lights, one of which shall at the same time fulfil the function of the forward masthead light. The other light shall be carried as required by 4.4.1.1.

**4.4.1.3** Ships of Group II shall carry two towing (white) lights to be placed as prescribed in 4.4.1.1 and 4.4.1.2, so that the vertical distance between them shall not be less than that specified in 4.1.9.2 (see also Note 1 to Table 2.4.1).

**4.4.1.4** The towing (yellow) light (see item 7 of Table 3.1.2) on towing ships shall be carried above the sternlight in a vertical line at a distance prescribed in 4.1.9.

**4.4.2 All-round lights for ships engaged in trawling.**

**4.4.2.1** Ships engaged in trawling shall carry two all-round lights placed in a vertical line one above the other, the upper being green and the lower white. Both all-round lights shall be fixed in accordance with the requirements of 4.1.7 and 4.1.9.

**4.4.2.2** Both lights described in 4.4.2.1 may be of either stationary or hoistable type with proper devices for their simultaneous hoisting and lowering down.

**4.4.2.3** In ships of 50 m in length and more engaged in trawling the after masthead light shall be positioned abaft of and higher than the all-round light of green colour. In ships of less than 50 m in length the light shall be carried in the same position if the masthead light mentioned in Note 6 to Table 2.4.1 is fixed.

**4.4.2.4** In ships engaged in trawling in close proximity to other ships or in pair trawling additional lights shall be placed where they can best be seen at a distance at least 0,9 m from the lights prescribed in 4.4.2.1 and below them, and the vertical distance between the additional lights shall be not less than 2 m.

**4.4.3 All-round lights for ships engaged in fishing.**

**4.4.3.1** Ships with outlying gear extending not more than 150 m horizontally from the ship shall carry two all-round lights (one with red light and the other with white light) to be placed as specified in 4.4.2.1 and 4.4.2.2 for the lights in ships engaged in trawling, the upper of these two lights being red. The lower light shall be placed above the sidelights at a height of not less than twice the distance between the all-round lights (red and white).

**4.4.3.2** Ships with outlying gear extending more than 150 m horizontally from the ship shall carry three all-round lights, two of which (one with red light and another with white light) shall be fixed as prescribed in 4.4.3.1, while the third light (with white light) shall be

placed at a horizontal distance of not less than 2 m nor more than 6 m away from the vertical lights in the direction of the outlying gear. This all-round light with white light shall be placed not higher than the all-round white light placed in pursuance of 4.4.3.1 and not lower than the sidelights.

**4.4.3.3** Ships engaged in fishing with purse seine gear in close proximity to other ships may place two all-round yellow lights in a vertical line where they can best be seen and at least 0,9 m apart but at a lower level than lights prescribed in 4.4.3.1.

These lights shall flash alternately every second and with equal light and occultation duration.

**4.4.4 All-round lights for pilot ships.**

Pilot ships shall carry two all-round lights in a vertical line one over the other, the upper being white and the lower red. The upper light shall be placed at or near the top of the foremast. Both all-round lights shall be fitted in a stationary position in accordance with the requirements of 4.1.7 and 4.1.9.

**4.4.5 Lights of "Ship restricted in her ability to manoeuvre" signal.**

**4.4.5.1** Ships restricted in their ability to manoeuvre shall exhibit three lights in combination in a vertical line one over the other. The highest and the lowest of these lights shall be red and the middle light shall be white. These all-round lights shall be placed in a position where they can best be seen according to the requirements of 4.1.7, 4.1.9 and 4.2.1.3.

When the arrangement of these all-round lights below the masthead lights is impracticable, they may be placed above the after masthead light provided the requirements of 4.1.9 are complied with, or at a height between the forward and after masthead lights. In the second case, they shall be carried at a horizontal distance of not less than 2 m from the centreline.

**4.4.5.2** Additional all-round lights on ships engaged in dredging or underwater operations prescribed in 2.4.2 for indication of the obstructed side (two all-round lights of red colour) and the side on which it is safe to pass (two all-round lights of green colour) shall be placed at the maximum practical horizontal distance, but in no case less than 2 m from the all-round lights prescribed in 4.4.5.1. On each side the all-round lights shall be placed vertically one over the other, and in no case shall the upper of these lights be at a greater height than the lower of three all-round lights prescribed in 4.4.5.1.

**4.4.6 Lights of the signal for sailing ships.**

When a sailing ship carries the all-round lights prescribed in 2.2.6, they shall be placed at or near the top of the foremast where they can best be seen. The all-round lights shall be placed vertically one over the other and spaced as specified in 4.1.9, the upper light being red and the lower green. These all-round lights

shall not be placed in conjunction with the combined three-colour light.

#### **4.4.7 Light of the signal for air-cushion ships.**

The light having the characteristics specified in item 9 of Table 3.1.2 shall be fitted in air-cushion ships so as to be visible all round the horizon. This light shall be of stationary type.

#### **4.4.8 Lights of the signal for ships constrained by their draught.**

When a ship carries the all-round lights prescribed in 2.2.9, they shall be exhibited where they can best be seen, vertically one over the other, and spaced as specified in 4.1.9.

When it is impracticable to place these all-round lights below the masthead lights, they may be placed above the after masthead light (lights), provided the prescribed vertical distance between them is observed, or vertically between the forward masthead light (lights) and after masthead light (lights); in the second case, these all-round lights shall be placed at a horizontal distance of not less than 2 m from the fore and aft centreline of the ship.

#### **4.4.9 Lights for ships or objects being towed.**

Inconspicuous, partly submerged ships or objects being towed or combination of such ships and objects shall exhibit all-round white navigation lights.

**4.4.9.1** When the breadth of the ship or object being towed is less than 25 m, one all-round light shall be placed at or near both fore and after extremities, except for flexible floating containers, for which the installation of the all-round light at or near the fore extremity is not required.

**4.4.9.2** When the breadth of the ship or object being towed is 25 m and more, two additional all-round lights are placed at the side extremities so that the distance between them closely approximates to the breadth of the ship or object.

**4.4.9.3** When the length of the ship or object being towed exceeds 100 m, additional all-round lights shall be exhibited between the lights prescribed in 4.4.9.1 and 4.4.9.2 so that the distance between them is not more than 100 m.

### **4.5 FLASHING LIGHTS**

#### **4.5.1 Daytime signalling lamp.**

A daytime signalling lamp shall be kept in the wheelhouse or chartroom, always ready for immediate use.

#### **4.5.2 Manoeuvring light.**

The manoeuvring light shall be placed in the same fore and aft vertical plane as the masthead lights and, where practicable, at a minimum height of 2 m above the forward masthead light, provided that it shall be carried not less than 2 m vertically above or below the after masthead light.

On a ship where only one masthead light is carried the manoeuvring light shall be placed where it can best be seen not less than 2 m vertically apart from the masthead light.

The manoeuvring light shall be so fixed that its light is visible all round the horizon.

If flashes are sent simultaneously with operation of sound signals, the possibility shall also be provided to show the light signals independently.

### **4.6 SOUND SIGNAL MEANS**

#### **4.6.1 General.**

**4.6.1.1** The sound signal means shall be so placed that the sound they produce could not be intercepted or its intensity and clearness impaired by any parts of the structure or equipment of the ship.

**4.6.1.2** Sound signal means drives shall be so constructed as to exclude their spontaneous sounding under the action of wind, snow, icing-up, etc.

#### **4.6.2 Whistles.**

**4.6.2.1** The whistles shall be so fixed that the centre of the sound source is at the height of not less than 2,5 m above the uppermost deck extending from side to side and at least 0,5 m above the deckhouse and any other structures on this deck, which can obstruct the propagation of sound.

The sound pressure level of the ship's own signal measured at listening posts of the passing ship (navigating and top bridges, wheelhouse and bridge wings) shall not exceed 110 dB and, as far as it is practicable, be not more than 100 dB. The whistle installed on a ship shall meet the requirements of Table 3.3.1.

A single whistle shall be so installed on a ship that its maximum intensity is directed straight ahead.

In the horizontal plane within  $\pm 45^\circ$  of the forward axis of the whistle (in the straight ahead direction) the sound pressure level of the whistle shall be not more than 4 dB below the prescribed sound pressure level on the forward axis. In any other direction in the horizontal plane the sound pressure level shall not be more than 10 dB below the prescribed sound pressure level on the forward axis, so that the audibility range in any direction will be at least half the range on the forward axis.

**4.6.2.2** The system of conveying steam or air shall be so designed as to ensure the supply of these media without condensation at all times and under any weather conditions.

**4.6.2.3** The control buttons or handles to actuate the whistle shall be located at the steering stations of the ship. In ships of unrestricted service and in ships of restricted area of navigation **R1** there shall be provided at least one button (handle) in the wheel-



house and one button (handle) on each of the bridge wings (if any), outside the wheelhouse. Other ships shall be provided with at least one button (handle) on each side of the bridge; ships of less than 20 m in length may have only one control button (handle).

**4.6.2.4** If whistles are fitted at a distance of more than 100 m apart, they shall be so arranged that they are not sounded simultaneously. If due to the presence of obstructions the sound field of a single whistle or one of the whistles is likely to have a zone of greatly reduced signal level, it is recommended that a combined whistle system be fitted so as to overcome this reduction. A combined whistle system shall be regarded as a single whistle. The whistles of this system shall be located at a distance of not more than 100 m apart and arranged to be sounded simultaneously. The frequency of any one whistle shall differ from that of the others by at least 10 Hz.

**4.6.2.5** In ships sailing in regions where icing of whistle might occur, provision shall be made for its heating.

**4.6.3 Bell.**

The bell shall be placed stationarily on the clear part of the forecastle deck, near the windlass or capstan and shall provide the sound pressure level not less than 110 dB at a distance of 1 m therefrom.

The bell shall be hung up in such a manner as to permit its free swinging through an angle of not less than 50° each way without touching any part of the structure or equipment of the ship.

**4.6.4 Gong.**

The gong shall be such that its tone and sounding differ distinctly from those of the bell of the ship and shall provide the sound pressure level not less than 110 dB at a distance of 1 m therefrom.

The gong shall be placed as near the after end of the ship as possible and at such a place where nothing will intercept the propagation of sound, and shall be hung up so as to comply with the requirements of 4.6.3.

A gong of up to 5 kg in mass needs not be fixed in a stationary position, but a special storage place shall be provided in the after part of the ship.

The gong beetle shall be kept in a special pocket to be fitted close to the gong.

**4.7 DEVICES FOR HOISTING AND STORING SIGNAL SHAPES**

**4.7.1** The ships shall be provided with proper devices (masts, stays with sufficient number of signal halyards) for hoisting the signal shapes.

**4.7.2** The signal shapes shall be stored near the navigating bridge or the devices for hoisting them to their regular positions.

The signal shapes of the non-self-propelled unmanned ships may be stored in the towing or service ships.

**4.8 ARRANGEMENTS FOR STORING PYROTECHNIC SIGNAL MEANS**

**4.8.1** For storing the pyrotechnic signal means, the ship shall be provided with special watertight metal lockers built into the deckhouse on the navigating bridge, or a metal box firmly secured on the bridge deck.

**4.9 ARRANGEMENTS FOR STORING SPARE LIGHTS**

**4.9.1** For storing the set of spare lights the ships of Group I shall be provided with a specially fitted storage room or a special light locker.

**4.9.2** The storage arrangements for oil lights and fuel mixture required by 2.2.5.5 shall comply with the requirements set forth in Part VI "Fire Protection" (2.1.5 and item 6 of Table 3.1.2.1) of Rules for the Classification and Construction of Sea-Going Ships.

## **5 ADDITIONAL SIGNAL MEANS FOR SHIPS OF RIVER-SEA NAVIGATION**

### **5.1 GENERAL**

**5.1.1** The river-sea ships shall, in addition to the signal means required by Sections 2, 3 and 4, be provided with signal means in accordance with the present Section.

**5.1.2** The list, disposition and order of exhibiting the navigation lights and daytime signal means are specified in the Rules of Navigation in Inland Waters of the Russian Federation and in the regional navigation rules.

### **5.2 EQUIPMENT OF SHIPS WITH SIGNAL MEANS**

**5.2.1** Ships of river-sea navigation shall, in addition to signal means required by Tables 2.2.1, 2.3.1 and 2.4.1, be provided with signal means required by Table 5.2.1.

**5.2.2** Navigation lights shall be electric. They shall be supplied in compliance with 6.8.2 and 9.3.1, Part XI "Electrical Equipment" of Rules for the Classification and Construction of Sea-Going Ships.

Table 5.2.1

| Ships          | Navigation lights |                         |  |                            |                                    | Daytime signal means                  |                       |
|----------------|-------------------|-------------------------|--|----------------------------|------------------------------------|---------------------------------------|-----------------------|
|                | Masthead          | Sternlight <sup>1</sup> | Light impulsive flashing lamp <sup>2</sup> | All-round red <sup>3</sup> | Side anchorage lights <sup>4</sup> | Signal flag "B" (shield) <sup>5</sup> | White arm signal flag |
| Self-propelled | 1                 | 3                       | 4  | 1                          | 2                                  | 1                                     | 1                     |

<sup>1</sup> Ships of 5 m in breadth and less are allowed to have one sternlight in the centreline.  
<sup>2</sup> It is recommended to fit additionally electric flashing lamps with incandescent lamps.  
<sup>3</sup> Required for ships carrying dangerous goods (explosives and noxious substances) or petroleum products.  
<sup>4</sup> Required for ships of more than 5 m in breadth.  
<sup>5</sup> Required for ships carrying petroleum products or dangerous goods.

**5.2.3** Each ship shall be provided with spare parts for navigation lights:

- .1 one light filter for each coloured light, provided no coloured lens is used in the light;
- .2 one electric bulb for each electric light.

### 5.3 TECHNICAL REQUIREMENTS FOR SIGNAL MEANS

**5.3.1** Main characteristics of navigation lights shall comply with the requirements of Table 5.3.1.

**5.3.2** Signal flags shall be manufactured of woollen flag cloth (bunting) of sufficient strength and fast colour. The flags may be of synthetic materials.

**5.3.3** Signal flags shall be of square shape. The square side size shall not be less than 1000 mm, and square side size of arm signal flags shall not be less than 700 mm. For ships of less than 20 m in length, a square side size of a flag shall not be less than 500 mm.

### 5.4 FITTING OF SIGNAL MEANS ON BOARD

**5.4.1** When several lights are fitted at the mast (one over the other), lighted simultaneously, the spacing of lights shall not be less than 1 m. In ships of less than 20 m in length they shall be spaced not less than 0,5 m apart.

#### 5.4.2 Masthead lights.

**5.4.2.1** The masthead lights shall be carried in the fore and aft centreline of the ship. The vertical separation of masthead light and sidelights shall not be less than 1 m (in ships of less than 20 m in length — 0,5 m).

**5.4.2.2** In self-propelled ships of 50 m in length and more the masthead lights shall be placed in the after and fore parts of the ship at a distance of not less than 20 m from one another. The vertical separation of them shall be such that in all normal conditions of trim the forward light was carried at least 1 m lower than the after one; and the forward masthead light may be located below the sidelights, and the after one — behind the sidelights and at least 1 m higher.

Table 5.3.1

| Nos | Light and colour               | Range of visibility not less than, km | Arc of visibility in horizontal plane |   |
|-----|--------------------------------|---------------------------------------|---------------------------------------|---|
|     |                                |                                       | Total angle, deg.                     | Position  |
| 1   | Masthead, white                | 8                                     | 225                                   | 112,5° from right ahead on either side from the fore and aft centreline of the ship   |
| 2   | Sidelight, green               | 3,7                                   | 112,5                                 | From right ahead to 22,5° abaft the beam on starboard side  |
| 3   | Sidelight, red                 | 3,7                                   | 112,5                                 | From right ahead to 22,5° abaft the beam on port side   |
| 4   | Sternlight, white              | 3,7                                   | 135                                   | 67,5° from right aft on either side   |
| 5   | All-round white                | 3,7                                   | 360                                   | All round the horizon   |
| 6   | All-round red                  | 1,85                                  |                                       |   |
| 7   | Side anchorage light, white    | 3,7                                   | 180                                   | 90° from the beam to right ahead and right aft  |
| 8   | Light-impulsive flashing lamp: |                                       |                                       |   |
|     | by day                         | 2                                     | 112,5+                                | From the beam to the bow with overlapping the fore and aft centreline by 22,5° and from the beam to the aft with overlapping the fore and aft centreline by 22,5° |
|     | by night                       | 4                                     | + 112,5                               |   |
| 9   | Light flashing lamp            | 4                                     | 112,5+                                | From the beam to the bow with overlapping the fore and aft centreline by 22,5° and from the beam to the aft with overlapping the fore and aft centreline by 22,5° |
|     |                                |                                       | + 112,5                               |   |

**5.4.2.3** In the ship which for passing under bridges shall have collapsible masts the reserve masthead light may be placed in the fore part of the ship and, in this case, it may be located below the sidelights. In ship of 50 m in length and more this light may be permanently used as a forward masthead light provided the requirements of 5.4.2.2 are satisfied.

**5.4.2.4** All masthead lights shall have protective shields from below to prevent blinding the persons on the bridge and deck.

**5.4.3 Sidelights.**

**5.4.3.1** Sidelights (red light on port side, green light on starboard side) shall be visible for head-on ships and ships to be overtaken within the specified angles of visibility. Lights and their protective shields shall not extend outside the greatest breadth of the ship.

**5.4.3.2** Sidelights shall be carried in a horizontal line symmetrically to the fore and aft centreline of the ship and shall be placed as follows:

**.1** in undecked ship — at a height of not less than 0,5 m above the gunwale (in well-grounded cases, it is permitted to place them at the gunwale level);

**.2** in ships with single-tier superstructure (deck-house) — in its upper part;

**.3** in ships with two- (or more) tier superstructure — not below the navigating bridge deck.

**5.4.3.3** Every sidelight shall be protected by inboard shield with two transverse screens (fore and aft).

In ships of 20 m in length and more the distance from outer edge of the protective glass or lens of the light to the aft edge of the fore transverse screens shall not be less than 915 mm. The length of shield for these lights shall be not less than 1 m.

Fore transverse screen shall be of such breadth that a line joining its outer edge and the centre of light source is parallel to the fore and aft centreline of the ship. Aft transverse screen shall be of such breadth as to mask completely the light from being seen across the stern, but not hinder showing its light to 22,5° abaft the beam.

**5.4.3.4** Sidelights may be placed in the recesses of superstructures and deckhouses. The dimensions of the recesses shall correspond to the dimensions of the light shields, and the recesses shall be fitted with the screens similar to those of light shield.

**5.4.3.5** Inner surfaces of the light shields shall be painted matt black.

**5.4.3.6** In ships of less than 20 m in length as well as in air-cushion ships and hydrofoil ships the dimensions of the shields may be reduced or the shields need not be installed in case the required angles of visibility are provided.

**5.4.4 Sternlights and towing (yellow) light.**

**5.4.4.1** In ships which carry one sternlight this light shall be fitted behind the funnel or superstructure in the fore and aft centreline of the ship and if practicable, at the same height as the sidelights, but not higher. In well-grounded cases, in ships of less than 20 m in length it is permitted to place a sternlight higher than the sidelights.

**5.4.4.2** In ships which carry three sternlights the highest light shall be placed as required by 5.4.4.1, and two lower lights shall be placed at bulwark or stern exposed bulkhead of superstructure as nearly as practicable to the sides in a horizontal line symmetrically to the fore and aft centreline of the ship.

**5.4.5 All-round and side anchorage lights.**

**5.4.5.1** All-round white light on self-propelled ships used at anchorage shall be placed in the fore part of the ship. The light may be fitted at the mast, flagstaff or may be raised at stay.

**5.4.5.2** All-round red light shall be placed above the all-round white light where it can best be seen and its all-round visibility is ensured. The light is not permitted to be fitted in a vertical line with anchorage lights.

**5.4.5.3** Side anchorage lights shall be placed on sides along the edge of the navigating bridge.

**5.4.6 Light-impulsive (light) flashing lamps.**

**5.4.6.1** Light-impulsive (light) flashing lamps shall be installed in a stationary position on each side of the ship in pairs (fore and aft) above the sidelights at a height of not less than 0,5 m from them.

**5.4.6.2** Light-impulsive flashing lamps shall be switched on separately.

**5.5 STORAGE OF SIGNAL FLAGS**

**5.5.1** For storage of signal flags, provision shall be made for special shelves with separate clearly indicated cell for each flag. The shelves shall be placed in the wheelhouse or at the navigating bridge in a position protected from precipitation and direct sunlight.

# PART IV. RADIO EQUIPMENT

---

## 1 GENERAL

### 1.1 APPLICATION

**1.1.1** The requirements of the present Part of the Rules apply to:

**.1** passenger and cargo ships engaged and not engaged in international voyages;

**.2** catching ships (fishing vessels, taking-over and transport ships, auxiliary and special purpose ships);

**.3** ships of river-sea navigation;

**.4** non-self-propelled ships with people on board towed or pushed at sea, or intended for prolonged anchorage outside the port water area and roads.

**1.1.2** The requirements of the present Part of the Rules apply to radio equipment which is subject to survey by the Register and intended for installation on board ships.

**1.1.3** The present Part of the Rules defines the technical requirements which the radio equipment shall comply with and specifies the list of such equipment, its arrangement on board and the maintenance and repair methods.

**1.1.4** The requirements of the present Part of the Rules apply to the ships and radio equipment whose technical documentation was submitted to the Register for review and approval after the entry into force of the Rules.

Ships under construction and the radio equipment whose technical documentation was approved by the Register prior to the entry into force of the Rules shall be subject to the Rules in force at the time of approval of the documentation unless specified otherwise in the relevant sections and chapters of the Rules.

**1.1.5** No provision in this part of the Rules shall prevent the use by any ship, survival craft or person in distress, of any means at their disposal to attract attention, make known their position and obtain help.

### 1.2 DEFINITIONS AND EXPLANATIONS

**1.2.1** Definitions and explanations relating to general and technical terminology of the Rules are given in Part I "Classification" of Rules for the Classification and Construction of Sea-Going Ships 1.2.1, in Part I "General Regulations for Technical Supervision" of the Rules for Technical Supervision during Construction of Ships and Manufacture of Materials and Products for Ships and in Radio Regulations accordingly.

**1.2.2** For the purpose of the present Part of the Rules, the following definitions have been adopted.

**Emergency position-indicating radio beacon (EPIRB)** is a station of the mobile service the emissions of which serve to facilitate search and rescue.

**Starting period** is the time necessary for radio equipment to become operational as measured from the moment of switching on the source of electrical power.

**Secondary means of alerting** is the means of initiating the transmission of ship-to-shore distress alerts by a separate and independent system.

**Global Maritime Distress and Safety System (GMDSS)** is an international radio communication system developed by the International Maritime Organization (IMO) whose requirements are brought to Amendments 1988-1989 to Chapter IV "Radio Communication" of the International Convention for the Safety of Life at Sea, 1974, and in present Part of the Rules.

**Two independent actions to initiate the distress alert:** lifting of the protective lid or cover is considered as the first independent action. Pressing the dedicated button for initiating the distress alert is considered as the second independent action.

**Additional channel** is the channel which is used in the absence of a signal at the priority channel.

**Global Maritime Distress and Safety System identities** means maritime mobile services identity, the ship's call sign, INMARSAT identities and serial number identity which may be transmitted by the ship's equipment and used to identify the ship.

**Radiated interference** is interference radiated by the casings of equipment, except for radiation of aerials.

**INMARSAT** is the Organization established by the Convention on the International Maritime Satellite Organization (INMARSAT) adopted on 3 September 1976. Since 9 December 1994 International Mobile Satellite Organization.

**Maritime safety information (MSI)** means navigational and meteorological warnings, meteorological forecasts and other urgent safety related messages broadcast to ships.

**Public address system** is an installation enabling the broadcast of the ship's Administration instructions into accommodation, service and public spaces as well as the ship's open decks.

**Conducted interference** is interference from equipment at the electric power supply terminals.

**COSPAS-SARSAT** is an international search and rescue system using polar orbitary satellite service for ships and aircraft in distress.

**Gain of aerial** is the ratio, usually expressed in decibels, of the power required at the input of a loss-free reference aerial to the power supplied to the input of the given aerial to produce, in a given direction, the same field strength or the same power flux-density at the same distance. When not specified otherwise, the gain refers to the direction of maximum radiation. The gain may be considered for a specified polarization.

**International NAVTEX Service** means the coordinated broadcast and automatic reception on 518 kHz of maritime safety information by means of narrow-band direct-printing telegraphy using the English language.

**International voyage of a fishing vessel** is a voyage with a call at a port of another Flag State.

**Navigating bridge** is the position from which the ship is normally navigated.

**Sea area A1** is an area within the radiotelephone coverage of at least one VHF coast station in which continuous digital selective calling (DSC) alerting is available.

**Sea area A2** is an area, excluding sea area A1, within the radiotelephone coverage of at least one MF coast station in which continuous DSC alerting is available.

**Sea area A3** is an area, excluding sea areas A1 and A2, within the coverage of an INMARSAT geostationary satellites in which continuous alerting is available.

**Sea area A4** is an area outside sea areas A1, A2 and A3.

Information for sea area definition is placed in the Appendix to the present Part.

**Effective radiated power** is the product of the power supplied to the aerial and the gain of this aerial with reference to a half-wave dipole in the prescribed direction.

**Carrier power of a radio transmitter** is the average power supplied to the aerial transmission line by a transmitter during high frequency cycle under conditions of no modulation.

This definition does not apply to pulse modulated emissions.

**Rated power of radio transmitter** is the minimum power within the frequency range of the transmitter transferred to the aerial or to the artificial aerial under normal operating and climatic conditions.

**Peak envelope power of radio transmitter** is the power supplied to the aerial transmission line by a transmitter averaged during one

radio frequency cycle at the highest crest of the modulation envelope under normal climatic conditions.

**Mean power of radio transmitter** is the power supplied to the aerial transmission line by a transmitter averaged over the time sufficiently long compared with the lowest frequency encountered in the modulation under normal operating conditions.

**Multiplexing** is the ability of the ship security surveillance TV system to simultaneously reproduce information from several TV cameras on the video display unit.

**Continuous watch** means that the radio watch concerned shall not be interrupted other than for brief intervals when the ship's receiving capability is impaired or blocked by its own communications or when the radio equipment is under periodical maintenance, repair or checks.

**Mobile radiotelephone station** is a radiotelephone station, providing operation while carrying and being fixed, and supplied from own source of electrical power.

**Locating** means the finding of ships, aircraft, units or persons in distress.

**Interference** is the influence of unwanted energy on reception in the radio communication system resulting in impaired quality, errors or loss of information that could have been avoided in the absence of influence of such unwanted energy.

**Interruption (termination) of the distress alert initiation at any time** means that interruption of the retry of the distress alert shall be provided. This action shall not interrupt the distress alert transmission or distress message during its transmission but shall preclude the retry of the distress alert.

**Priority channel** means the channel which is listened to during the whole period of reception of a signal at the additional channel.

**New radio equipment** is radio equipment developed in compliance with the technical documentation submitted after the date of coming into force of the present Part of the Rules.

**Existing radio equipment** is radio equipment which is not new radio equipment.

**General radiocommunication** means operational and public correspondence traffic, other than distress, urgency and safety messages, conducted by radio.

**Enhanced group calling (EGC)** means the system for broadcast transmit of urgency, distress and safety messages by mobile satellite communication system of INMARSAT.

**Radio Regulations** means the Radio Regulations annexed to, or regarded as being annexed to, the most recent International Telecommunication Convention which is in force at any time.

Fishing vessel is a vessel used directly for catching or for catching and processing the catch (fish, whales, seals, walrus or other living resources of the sea).

Bridge-to-bridge communications means safety communications between ships from the position from which the ships are normally navigated.

Ship security alert system is a system, which provides the generation and transmission of covert security alert or report to indicate a competent organization designated by the Administration that the security of the ship is under the threat.

Polar orbiting satellite service means a service which is based on polar orbiting satellites which receive and relay distress alerts from satellite EPIRBs and which provides their position.

Rescue unit is a unit with full complement of trained persons and equipment available for rapid carrying out search and rescue operations.

A dedicated distress alert button is an unique clearly indicated button physically separated from the controls (buttons, keys of keyboards used for normal operation of equipment and not intended for any other purposes except distress alert initiation. This button shall be red in colour and marked "DISASTER" (or "DISTRESS"). If the button is protected from the unintended activation by opaque cap or cover, an inscription "DISASTER" (or "DISTRESS") shall be also made on it.

Satellite radio communication facilities are radio communication facilities intended for transmitting or receiving messages within the frequency range of 1500 to 1700 MHz, with the use of artificial earth satellites as relays of the transmitted radio signals.

Ships constructed are ships at the following stage of the construction:

the keel is laid;

construction identifiable with a specific ship is started;

assembly of that ship has commenced comprising at least 50 tons or 1 per cent of the estimated mass of all structural material, whichever is less.

Ship Earth Station is a mobile earth station of the Maritime Mobile Satellite Service fitted on board a ship.

Ship security surveillance TV system is a video surveillance system capable of displaying and storing video information received from TV cameras.

Narrow-band direct-printing telegraphy (NDPT) is a communication technique using automated telegraphy facilities which comply with the relevant recommendations of the International Telecommunication Union (ITU).

Two-way VHF radiotelephone apparatus is an apparatus intended for communication between survival craft, between survival craft and ship, between survival craft and rescue unit, and between ship and aircraft.

Digital selective calling (DSC) means a technique using digital codes which enables a radio station to establish contact with, and transfer information to, another station or group of stations, and complying with the relevant recommendations of the International Telecommunication Union (ITU).

Equivalent isotropically radiated power is the product of the power supplied to the aerial and the amplification factor of this aerial in the prescribed direction about the isotropic aerial.

### 1.3 SCOPE OF SURVEY

**1.3.1** General provisions for the procedure of survey of the radio equipment, as well as the requirements for the technical documentation to be submitted for review to the Register, and information on documents for radio equipment issued by the Register, are set out in General Regulations for the Classification and Other Activity, Part II "Technical Documentation" of the Rules for Technical Supervision during Construction of Ships and Manufacture of Materials and Products for Ships and Part I "Survey Regulations".

**1.3.2** The Register carries out technical supervision during design and survey during manufacture, installation and operation of the following shipboard radio equipment:

**1.3.2.1** Radio communication facilities:

**.1** VHF radio installation:

DSC encoder,

DSC watch receiver,

radiotelephone station;

**.2** MF radio installation:

DSC encoder,

DSC watch receiver,

radiotelephone station;

**.3** MF/HF radio installation:

DSC encoder,

DSC watch receiver,

telephony and narrow-band direct-printing (NBDP) receiver,

telephony and NBDP transmitter,

direct-printing apparatus of improved fidelity,

terminal printing device;

**.4** INMARSAT ship earth station;

**.5** main, operational and portable VHF radiotelephone station in the frequency bands of 300,025 MHz to 300,500 MHz and 336,025 MHz to 336,500 MHz;

.6 two-way VHF radiotelephone apparatus with aircrafts;

.7 radiotelephone station intended for internal service communication.

1.3.2.2 Facilities for reception of maritime safety information:

- .1 NAVTEX service receiver,
- .2 enhanced group calling (EGC) receiver,
- .3 HF direct-printing telegraph receiver.

1.3.2.3 COSPAS-SARSAT satellite EPIRB.

1.3.2.4 VHP EPIRB.

1.3.2.5 Ship's radar transponder.

1.3.2.6 Public address system.

1.3.2.7 Survival craft radio equipment:

- .1 radar transponder,
- .2 two-way VHF radiotelephone apparatus.

1.3.2.8 Ship security equipment:

- .1 ship security alert system;
- .2 ship security surveillance TV system.

1.3.2.9 Facsimile receiving device.

1.3.2.10 Source of electrical power.

1.3.2.11 Automatic battery charger.

1.3.2.12 Uninterruptible power supply unit.

1.3.2.13 Aerial.

1.3.2.14 Cabling.

1.3.2.15 Earthing.

1.3.2.16 Systems, radio equipment and arrangements other than those stated above if required by the Register.

1.3.3 Technical supervision during design and survey during manufacture of shipborne radio equipment by the Register covers:

.1 consideration of technical documentation for radio equipment;

.2 consideration of the programme and procedure of works tests of an experimental model;

.3 survey during works tests of the experimental model;

.4 consideration of the programme and procedure of shipboard tests of the experimental model;

.5 survey during shipboard tests of the experimental model;

.6 consideration of technical documentation reflecting changes made upon results of the works and shipboard tests of the experimental model;

.7 survey during the manufacture of radio equipment under serial production.

1.3.4 Prior to the commencement of technical supervision during design and survey during manufacture of radio equipment the following technical documentation shall be submitted to the Register for review:

.1 technical description,

.2 block and schematic diagram with a list of components,

.3 general view drawing,

.4 wiring instruction and diagram,

.5 list of spare parts,

.6 programme of tests.

The said technical documentation shall be presented at least in two copies.

1.3.5 The experimental model of radio equipment, developed and manufactured in compliance with the technical documentation, shall be subjected to works and shipboard tests for the purpose of verifying the performance characteristics being in compliance with the Rules and the technical documentation. The tests shall be carried out under the technical supervision of the Register.

1.3.6 On completion of the works and shipboard tests of the radio equipment experimental models, all test reports and records as well as photos of new radio equipment shall be submitted to the Register. All these materials are kept at the Register and they serve as a basis for conclusion whether this radio equipment may be applied on ships with the relevant documents being issued.

1.3.7 Acceptance of new and existing radio equipment developed not under the technical supervision of the Register is carried out on the ground of consideration of technical documentation (description, diagrams, test records, etc.) and performance of the tests in compliance with the requirements specified in the present Part of the Rules.

1.3.8 When new radio equipment is fitted or outdated (broken-down and unrepairable) equipment is replaced on ships in service, the installation technical design and working drawings shall be submitted to the Register for review prior to the commencement of survey of the radio equipment.

The technical design shall contain information on the sea areas where the ship is intended to operate and on the radio equipment maintenance and repair methods.

After the approval of the technical design and working drawings, the radio equipment fitted on board shall be surveyed and tested in operation.

1.3.9 On ships under construction, the operation tests of radio equipment and the tests for electromagnetic compatibility with other electrical and electronic equipment shall be carried out during mooring and sea trials according to the programs approved by the Register.

## 2 FUNCTIONAL REQUIREMENTS FOR RADIO EQUIPMENT, ITS COMPOSITION, MAINTENANCE AND REPAIR

### 2.1 FUNCTIONAL REQUIREMENTS

**2.1.1** Every ship, while at sea, shall be capable:

**.1** of transmitting ship-to-shore distress alerts by at least two separate and independent means, each using a different radiocommunication service.

If the serviceability of the radio equipment fitted on board is ensured by a means such as duplication of equipment, the above requirements shall be considered fulfilled (also see note 1 to Table 2.2.1);

**.2** of receiving shore-to-ship distress alerts;

**.3** of transmitting and receiving ship-to-ship distress alerts;

**.4** of transmitting and receiving search and rescue co-ordinating communications;

**.5** of transmitting and receiving on-scene communications;

**.6** of transmitting and receiving signals for locating;

**.7** of transmitting and receiving maritime safety information, also having regard to the need for reception of such information by ships in port;

**.8** of transmitting and receiving general radio-communications to and from shore-based systems or networks;

**.9** of transmitting and receiving bridge-to-bridge communications.

**2.1.2** In fulfilling the functional requirements for radio equipment, care shall be taken to preclude the transmission of false distress signals.

### 2.2 LIST OF RADIO EQUIPMENT

**2.2.1** The minimum list of radio equipment is determined by the sea areas where the ship is intended to operate: A1; A1 and A2; A1, A2 and A3; A1, A2, A3 and A4. Every ship, except for the ships mentioned in 2.2.4 and 2.2.5 according to the navigation areas shall be fitted with the radio equipment in compliance with Table 2.2.1.

**2.2.2** In addition to the requirements of Table 2.2.1, it is recommended that ships should be equipped with security surveillance TV system and facsimile receiving equipment.

**2.2.3** In addition to the requirements of Table 2.2.1, every ship of river-sea navigation engaged in voyages along inland waterways shall be fitted with:

**.1** main VHF radiotelephone station (300,025 MHz to 300,500 MHz);

**.2** operational VHF radiotelephone station (300,025 MHz to 300,500 MHz; 336,025 MHz to 336,500 MHz);

**.3** portable VHF radiotelephone station (300,025 MHz to 300,225 MHz) — 2 sets;

**.4** command broadcast apparatus.

The type of the VHF radiotelephone station shall be determined by the shipowner based on the system of communications established in the ship's operational area.

**2.2.4** Every fishing vessel of less than 24 meters in length and cargo ship of under 300 gross tonnage, non-self-propelled ship with people on board towed or pushed at sea, or intended for the prolonged anchorage outside the port water area and roads, as well as to ships not engaged in international voyages while navigating in sea area A1 shall be fitted with the equipment as listed in Table 2.2.1:

**.1** VHF radio installation;

**.2** free-floating COSPAS-SARSAT satellite EPIRB;

**.3** ship's radar transponder;

**.4** two-way VHF radiotelephone apparatus (2 sets).

In addition to the above-said the following equipment shall be fitted:

for the ships intended for navigation in sea areas A1 and A2:

MF radio installation;

NAVTEX service receiver or EG receiver if the ship operates in areas not covered by the international NAVTEX service;

for ships intended for navigation in sea areas A1, A2 and A3 and in sea areas A1, A2, A3 and A4:

MF radio installation;

INMARSAT ship earth station and EGC receiver or MF/HF radio installation and maritime safety information receiver;

NAVTEX service receiver, except for the ships continually operated outside the coverage of this service.

**2.2.5** Every ship intended for navigation inside the port water area on the inner road within the harbor water area (regardless of the established sea area), shall be fitted with the following equipment as listed in the Table 2.2.1:

**.1** VHF radio installation;

**.2** radar transponder;

**.3** two-way VHF radiotelephone apparatus (1 set).

In addition to the list of equipment as indicated every ship intended for navigation outside the port water area on the outer road within the harbor water area, shall be fitted with a free-floating COSPAS-SARSAT



Table 2.2.1

| Nos       | Radio equipment <sup>1</sup>   | Amount of equipment for ships sea areas |                     |                     |                     |
|-----------|--|---|---------------------|---------------------|---------------------|
|           |  | A1                                      | A1 and A2           | A1, A2 and A3       | A1, A2, A3 and A4   |
| 1         | 2  | 3                                       | 4                   | 5                   | 6                   |
| <b>1</b>  | VHF radio installation <sup>2</sup> :  |   |                     |                     |                     |
|           | DSC encoder  | 1                                       | 1                   | 1                   | 1                   |
|           | DSC watch receiver   | 1                                       | 1                   | 1                   | 1                   |
|           | radiotelephone station <sup>3</sup>  | 1                                       | 1                   | 1                   | 1                   |
| <b>2</b>  | MF radio installation <sup>2, 4</sup> :  |   |                     |                     |                     |
|           | DSC encoder  | —                                       | 1                   | 1                   | —                   |
|           | DSC watch receiver   | —                                       | 1                   | 1                   | —                   |
|           | radiotelephone station   | —                                       | 1 <sup>5</sup>      | 1                   | —                   |
| <b>3</b>  | MF/HF radio installation <sup>2</sup> :  |   |                     |                     |                     |
|           | DSC encoder  | —                                       | —                   | 1 <sup>6</sup>      | 1                   |
|           | DSC watch receiver   | —                                       | —                   | 1 <sup>6</sup>      | 1                   |
|           | telephony and NBDP receiver  | —                                       | —                   | 1 <sup>6, 7</sup>   | 1 <sup>7</sup>      |
|           | telephony and NBDP transmitter   | —                                       | —                   | 1 <sup>6, 7</sup>   | 1 <sup>7</sup>      |
|           | direct-printing apparatus of improved fidelity                                     | —                                       | —                   | 1 <sup>6</sup>      | 1                   |
|           | terminal printing device   | —                                       | —                   | 1 <sup>6</sup>      | 1                   |
| <b>4</b>  | INMARSAT ship earth station  | —                                       | —                   | 1 <sup>4</sup>      | —                   |
| <b>5</b>  | Ship security alert system   | 1 <sup>8</sup>                          | 1 <sup>8</sup>      | 1 <sup>8</sup>      | 1 <sup>8</sup>      |
| <b>6</b>  | NAVTEX service receiver  | 1 <sup>9</sup>                          | 1 <sup>9</sup>      | 1 <sup>9</sup>      | 1 <sup>9</sup>      |
| <b>7</b>  | EGC receiver   | 1 <sup>10, 11</sup>                     | 1 <sup>10, 11</sup> | 1 <sup>10, 11</sup> | 1 <sup>10, 11</sup> |
| <b>8</b>  | HF direct-printing telegraph receiver for reception of maritime safety information | 1 <sup>12</sup>                         | 1 <sup>12</sup>     | 1 <sup>12</sup>     | 1 <sup>12</sup>     |
| <b>9</b>  | COSPAS-SARSAT satellite EPIRB <sup>13</sup>  | 2 <sup>14</sup>                         | 2 <sup>14</sup>     | 2 <sup>14</sup>     | 2                   |
| <b>10</b> | VHF EPIRB  | 1 <sup>15</sup>                         | —                   | —                   | —                   |
| <b>11</b> | Ship's radar transponder   | 1 <sup>16</sup>                         | 1 <sup>16</sup>     | 1 <sup>16</sup>     | 1 <sup>16</sup>     |
| <b>12</b> | Two-way VHF radiotelephone apparatus for communication with aircraft <sup>17</sup> | 1 <sup>18</sup>                         | 1 <sup>18</sup>     | 1 <sup>18</sup>     | 1 <sup>18</sup>     |
| <b>13</b> | Command broadcast apparatus <sup>20</sup>  | 1 <sup>19</sup>                         | 1 <sup>19</sup>     | 1 <sup>19</sup>     | 1 <sup>19</sup>     |
| <b>14</b> | Survival craft radar transponder   | — <sup>21</sup>                         | — <sup>21</sup>     | — <sup>21</sup>     | — <sup>21</sup>     |
| <b>15</b> | Two-way VHF radiotelephone apparatus   | — <sup>21</sup>                         | — <sup>21</sup>     | — <sup>21</sup>     | — <sup>21</sup>     |

<sup>1</sup>In addition to the radio equipment required under 2.2.1, every ship shall be fitted with the second independent facility of transmission of distress alerts.

If a ship is engaged in voyages in sea area A1, then for this area a second VHF radio installation using DSC without a special receiver capable of maintaining a continuous DSC watch on channel 70, or a VHF EPIRB, or a MF radio installation using DSC (if a ship is engaged in voyages in the sea area covered by shore-based MF stations using DSC), or a HF radio installation using DSC, or an INMARSAT ship earth station, or a COSPAS-SARSAT satellite EPIRB may be used as a second independent facility of transmission of distress alerts.

If a ship is engaged in voyages in sea areas A1 and A2 or A1, A2 and A3, then for these sea areas an additional INMARSAT ship earth station, or COSPAS-SARSAT satellite EPIRB, or a HF radio installation using DSC (unless it is installed as the basic one required under 2.2.1 for sea areas A1, A2 and A3) may be used as a second independent facility of transmission of distress alerts.

If a ship is engaged in voyages in sea areas A1, A2, A3 and A4, then for these sea areas a COSPAS-SARSAT satellite EPIRB may be used as a second independent facility of transmission of distress alerts.

If the serviceability of the equipment fitted in accordance with 2.2.1. is ensured by its duplication, the second independent facility of transmission of distress alerts need not be fitted (reference is made to 2.6.3) provided that there is a second independent facility in the duplicated equipment.

<sup>2</sup>A combined radio installation or in the form of separate devices may be permitted.

<sup>3</sup>Continuous listening watch on channel 16 shall not be limited by any date of discontinuation.

<sup>4</sup>Not required with the MF/HF radio installation.

<sup>5</sup>If the radiotelephone station is not capable of transmitting and receiving general radiocommunications on working frequencies within the range of 1605 to 4000 kHz, a separate radio installation or MF/HF radio installation capable of transmitting and receiving general radiocommunications using radiotelephony or direct-printing telegraphy, or an INMARSAT ship earth station shall be provided.

<sup>6</sup>Not required with an INMARSAT ship earth station.

<sup>7</sup>If the MF/HF radio installation is not capable of transmitting and receiving general radiocommunications on working frequencies within the range of 1605 to 4000 kHz and 4000 to 27500 kHz, a separate radio installation capable of transmitting and receiving general radiocommunications using radiotelephony and direct-printing telegraphy shall be provided.

<sup>8</sup>Required for all passenger ships including passenger high-speed craft, for cargo ships including high-speed craft, of 500 gross tonnage and upwards engaged in international voyages.

<sup>9</sup>Installation of the receiver is obligatory if the ship is engaged in voyages in any area in which an International NAVTEX service is provided.

<sup>10</sup>Allowed as a part of an INMARSAT ship earth station.

<sup>11</sup>Installation of the receiver is obligatory if the ship is engaged in voyages in any area within coverage of an INMARSAT geostationary satellites in which an International NAVTEX service is not provided. Installation of the receiver is not obligatory if the ships are engaged exclusively in the areas where an International NAVTEX service is provided and which may be announced by means of individual calling.

<sup>12</sup>It is allowed to install this receiver instead of the EGC receiver on the ships engaged exclusively in voyages in an area in which a HF direct-printing telegraphy maritime safety information service is provided.

<sup>13</sup>One of them shall be float-free.

<sup>14</sup>Single EPIRB may be installed (see 3.6.2) if the position from which the ship is normally navigated is capable of transmitting distress alerts by at least two separate and independent facilities, each using different types of communication suitable for the ship's navigation area (see Note 1).

<sup>15</sup>It is allowed on the ships engaged exclusively on voyages in sea area A1, upon agreement with the Register, to install a VHF EPIRB in lieu of the COSPAS-SARSAT EPIRBs.

<sup>16</sup>May be one of survival craft radar transponders.

<sup>17</sup>Required for passenger ships.

<sup>18</sup>Two sets are recommended, one set being mobile.

<sup>19</sup>Cargo ships are exempted from the requirement for installation of command broadcast apparatus.

<sup>20</sup>It is recommended to install the command broadcast apparatus on cargo ships.

<sup>21</sup>Provisions for fitting the ships with radio equipment for survival craft are specified in Part II "Life-Saving Appliances".

satellite EPIRB. It is permitted to install a VHF EPIRB in lieu of the COSPAS-SARSAT satellite EPIRB if the outer road within the harbor water area corresponds to sea area A1.

**2.2.6** In oil tankers (irrespective of a flash point of oil products), oil recovery vessels (irrespective of a flash point of oil products), gas carriers and chemical tankers, the aerial power of transmitters on carrier frequency shall not exceed 500 W. In this case, the peak power of the transmitter shall not exceed 1000 W.

Portable radio equipment (two-way VHF radiotelephone apparatus with a replaceable accumulator battery, VHF radiotelephone station, VHF radiotelephone station for service communication) used in the following ship types shall be of intrinsically safe type:

**.1** oil tankers intended for the carriage of oil products having a flash point of 60 °C and below or for the carriage of oil products having a flash point over 60 °C, which shall be heated up to a temperature less than by 15 °C below the flash point;

**.2** oil recovery vessels intended for the recovery and transportation of crude oil and/or oil products spread over the sea surface;

**.3** gas carriers;

**.4** chemical tankers intended for the carriage of cargoes having a flash point of 60 °C and below.

The two-way VHF radiotelephone apparatus, wherein replaceable accumulator batteries are not used, of a type other than intrinsically safe may be fitted in the above ships, provided that it is used as the radio equipment of life-saving appliances only. In this case, such equipment shall be stored in a way to preclude its use onboard the ship, and the route to the life-saving appliance outside dangerous areas shall be developed, agreed with the Register and prominently displayed near the storage area.

**2.2.7** Radio equipment not specified in this Section may be accepted for installation on board ships as additional equipment, provided that it complies with the requirements of 5.1 and its operation does not affect the operation of the main radio equipment or impair safety of navigation. Installation of additional equipment is subject to special consideration by the Register in each case.

**2.2.8** Every ship, while at sea shall maintain a continuous watch:

**.1** on VHF DSC channel 70, if the ship, in accordance with the requirements of the Rules for all sea areas, is fitted with a VHF radio installation;

**.2** on the distress and safety DSC frequency 2,187.5 kHz, if the ship, in accordance with the requirements of the Rules for sea areas A1 and A2 or A1, A2 and A3, is fitted with a MF radio installation;

**.3** on the distress and safety DSC frequencies 2,187.5 kHz and 8,414.5 kHz and also on one of the distress and safety DSC frequencies 4,207.5 kHz, 6,312 kHz, 12,577 kHz or 16,804.5 kHz, appropriate to the time of the day and the geographical position of the ship, if the ship, in accordance with the requirements of the Rules for sea areas A1, A2 and A3 or A1, A2, A3 and A4, is fitted with a MF/HF radio installation. This watch may be kept by means of a scanning receiver;

**.4** for shore-to-ship distress alerts, if the ship, in accordance with the requirements of the Rules for sea areas A1, A2, A3 and A4, is fitted with an INMARSAT ship earth station.

**2.2.9** Every ship, while at sea, shall maintain a radio watch for broadcasts of maritime safety information on the appropriate frequency or frequencies on which such information is broadcast for the sea area in which the ship is navigating.

**2.2.10** Every ship while at sea shall maintain, when practicable, a continuous listening watch on VHF Channel 16. This watch shall be kept at the position from which the ship is normally navigated.

**2.2.11** Every ship which after completion of construction shall undertake a single voyage to the place of its supplementary outfitting may be exempted from the requirement for installation of the full complement of the statutory radio equipment, if it is capable of transmitting shore-to-ship distress alerts by at least two separate and independent facilities, each using different types of radio communication. In this case, the full complement of the statutory radio equipment is subject to special consideration by the Register in each separate case.

### 2.3 SOURCES OF POWER

**2.3.1** There shall be available at all times, while the ship is at sea, a supply of electrical energy sufficient to operate the radio equipment as well as to charge a reserve source of electrical power.

**2.3.2** Conditions for providing power supply of radio equipment from an emergency source of power in cases when the supply of electrical power from the main sources of power is discontinued are regulated in Part XI "Electrical Equipment" of Rules for the Classification and Construction of Sea-Going Ships.

**2.3.3** A reserve source of electrical power shall be provided on every ship to supply radio installation, for the purpose of conducting distress and safety radio-communications, in the event of failure of the ship's main and emergency sources of electrical power.

In this case, the provision shall be made for visual and audible signalling system for switching to a reserve source of electrical power at the position from which the ship is normally navigated.

Electrical power shall be supplied to this signalling system by means of the emergency source of electrical power.

The signalling system shall be non-disconnectable and capable of being automatically reset after the power supply from the ship mains has been restored. Provision shall be made for manual acknowledgement of audible signals.

Where a manual switch is used for changing-over to a reserve source of electrical power to supply radio installation, it shall be fitted at the position from which the ship is normally navigated and shall be distinctly marked and readily accessed.

Changing-over to a reserve source of electrical power shall not result in the loss of data stored in the equipment memory.

The reserve source of electrical power shall be independent of the propelling power of the ship and the ship's electrical network.

A rechargeable accumulator battery with an automatic charging device or a source of uninterrupted power supply may be provided as the reserve source of power.

**2.3.4** The sources of electrical power for radio equipment shall comply with the requirements specified in Table 2.3.4.

**2.3.5** The reserve source of electrical power shall be capable of simultaneously operating the radio equipment in compliance with Table 2.3.4 and, as appropriate, for the sea area or sea areas for which the ship is equipped and any of the additional loads mentioned in 2.3.8 and 2.3.9 for a period of at least:

**.1** one hour, on ships where diesel generator is used as an emergency source of electrical power;

**.2** six hours, on ships where accumulator battery is used as an emergency source of electrical power;

**.3** one hour, on ships intended for navigation on the inner and/or outer road of the port basin, if an accumulator battery is used as an emergency source of electrical power.

**2.3.6** Capacity of accumulator battery used as reserve source of electrical power shall be determined proceeding from the power required by each radio installation (Table 2.3.4) with regard to the sum of the three values:

**.1** 1/2 of the current consumed for transmission mode;

**.2** current consumed for reception mode;

**.3** current consumed by additional loads.

It's advisable to provide a 40 per cent increase of the design value to take account of possible reduction in capacity of an accumulator battery in operation.

**2.3.7** The capacity of the accumulator battery shall be checked using a relevant method at intervals not exceeding 12 months, when the ship is not at sea.

When installed on board, accumulator batteries shall always have a clear marking containing the following data:

**.1** type of the battery or a construction;

**.2** date when the battery or construction was installed;

**.3** capacity at 1h discharge rate;

**.4** capacity at 1h discharge rate.

In way of the accumulator batteries of a non-tight type that are installed, there shall be a plate warning of explosion.

**2.3.8** If, in addition to the VHF radio installation, two or more radio installations for which the reserve supplying is required, can be connected to the reserve source of electrical power, it shall be capable of simultaneously supplying for the period specified in 2.3.5.1 or 2.3.5.2, the VHF radio installations in compliance with Table 2.3.4 and:

**.1** all other radio installations which can be connected to the reserve source of electrical power at the same time; or

**.2** whichever of the other radio installations will consume the most power, if only one of the other radio installations can be connected to the reserve source of electrical power at the same time as the VHF radio installation.

**2.3.9** The reserve source of electrical power may be used for the electrical lighting of the controls of the VHF radio installation as well as the radio installation complying with the sea area in which the ship is navigating.

**2.3.10** If the reserve source of electrical power consists of rechargeable accumulator battery, an automatic charging device shall be provided, which shall be capable of recharging the accumulator battery within 10 h (see 2.3.13).

Table 2.3.4

| Nos | Radio equipment   | Main source | Emergency source  | Reserve source to supply radio installation | Feed source integrated in radio equipment built in radio equipment |
|-----|---|-------------|-------------------|---|--|
| 1   | 2   | 3           | 4                 | 5   | 6  |
| 1   | VHF radio installation:   |             |                   |   |  |
|     | DSC encoder   | +           | + <sup>1, 2</sup> | +   | —  |
|     | DSC watch receiver  | +           | + <sup>1, 2</sup> | +   | —  |
|     | radiotelephone station  | +           | + <sup>1, 2</sup> | +   | —  |
| 2   | MF radio installation:  |             |                   |   |  |
|     | DSC encoder   | +           | + <sup>1, 2</sup> | +   | —  |
|     | DSC watch receiver  | +           | + <sup>1, 2</sup> | +   | —  |
|     | radiotelephone station  | +           | + <sup>1, 2</sup> | +   | —  |
| 3   | MF/HF radio installation:   |             |                   |   |  |
|     | DSC encoder   | +           | + <sup>1, 2</sup> | +   | —  |
|     | DSC watch receiver  | +           | + <sup>1, 2</sup> | +   | —  |
|     | telephony and NBDP receiver   | +           | + <sup>1, 2</sup> | +   | —  |
|     | telephony DSC and NBDP transmitter  | +           | + <sup>1, 2</sup> | +   | —  |
|     | direct-printing apparatus of improved fidelity  | +           | + <sup>1, 2</sup> | +   | —  |
|     | terminal printing device;   | +           | + <sup>1, 2</sup> | +   | —  |
| 4   | INMARSAT ship earth station   | +           | + <sup>1, 2</sup> | +   | +  |
| 5   | Ship security alert system  | +           | +                 | + <sup>3</sup>                              | —  |
| 6   | NAVTEX service receiver   | +           | +                 | —   | +  |
| 7   | EGC receiver  | +           | +                 | —   | +  |
| 8   | HF direct-printing telegraph receiver for reception of MSI                                | +           | +                 | —   | +  |
| 9   | COSPAS-SARSAT satellite EPIRB   | —           | —                 | —   | + <sup>4</sup>   |
| 10  | VHF EPIRB   | —           | —                 | —   | + <sup>4</sup>   |
| 11  | Command broadcast apparatus <sup>5</sup>  | +           | +                 | —   | —  |
| 12  | Two-way VHF radiotelephone apparatus  | —           | —                 | —   | + <sup>6</sup>   |
| 13  | Ship and survival craft radar transponder   | —           | —                 | —   | + <sup>7</sup>   |
| 14  | Main and operational VHF radiotelephone stations  | +           | + <sup>8</sup>    | + <sup>9</sup>                              | —  |
| 15  | Portable VHF radiotelephone station   | —           | —                 | —   | + <sup>10</sup>  |
| 16  | Two-way VHF radiotelephone apparatus intended for communication with aircrafts            | —           | —                 | —   | + <sup>6</sup>   |
| 17  | Stationery two-way VHF radiotelephone apparatus intended for communication with aircrafts | +           | +                 | —   | —  |
| 18  | Ship Security Surveillance TV System  | +           | +                 | —   | —  |

<sup>1</sup>If an accumulator battery is used as an emergency source of electric power, feeding from the reserve power source shall be provided in accordance with 2.3.5.2, 2.3.5.3, 2.3.13.

<sup>2</sup>The emergency source of electrical power shall be capable of operating the radio equipment for a period required by Sections 9 and 19, Part XI "Electrical Equipment" of Rules for the Classification and Construction of Sea-Going Ships.

<sup>3</sup>Required if the radio equipment supplied, according to 2.3.4, from a reserve source of power is used for transmitting an alert on the ship security threat.

<sup>4</sup>The source of electrical power shall have sufficient capacity to operate the EPIRB for a period of at least 48 h.

<sup>5</sup>The supply from the emergency transient source of electrical power shall be also provided if such source is required in Part XI "Electrical Equipment" of Rules for the Classification and Construction of Sea-Going Ships.

<sup>6</sup>Primary power supply batteries shall have sufficient capacity to ensure 8 h operation at its highest rated power with a duty cycle of 1:9. This duty cycle is defined as 6 s — transmission, 6 s — reception above squelch opening level and 48 s — reception below squelch opening level.

<sup>7</sup>The source of electrical power shall have sufficient capacity to operate in the stand-by condition for 96 h and, in addition, following the stand-by period, to provide transponder transmissions for 8 h when being continuously interrogated with a pulse repetition frequency of 1 kHz.

<sup>8</sup>Not required if supplied from the reserve source of electrical power.

<sup>9</sup>The source of electrical power shall have sufficient capacity to provide operation of the transmitter at full power for a period of at least 1 h and of the receiver for a period of 24 h. It is required for the main VHF radiotelephone station only.

It is required for the main VHF radiotelephone station only, if provision is not made for the power supply from the reserve electrical power source.

<sup>10</sup>The source of electrical power shall have sufficient capacity to ensure 4 h operation at its highest rated power with a duty cycle of 1:9.

<sup>11</sup>See 7.2.17.

The automatic charging device shall be operational within five seconds of switching on or after interruption of power supply from the main and/or emergency shipboard source of electrical power.

The automatic charging device shall be designed and constructed so that it is protected against damage

resulting from disconnecting the batteries or, with the battery disconnected, short-circuiting the battery connections. If this protection is provided by electronic means it shall reset automatically following the removal of the open or short-circuit conditions.

In the automatic charging device provision shall be made for light indication of the device operation, as well as indication of the battery charging/discharging voltage and current intensity.

In the automatic charging device provision shall be made for audible and visual alarms, indicating when the charging voltage or current is above the limits determined by the accumulator battery manufacturer. A protection shall be provided against overcharging or discharging of accumulator batteries due to possible faults in the charging device.

Alarm shall be non-disconnectable and capable of being automatically reset after the normal charging conditions of accumulator battery has been restored. Provision shall be made for manual acknowledgement of the audible alarm.

Failure of the said alarms shall not interrupt charging or discharging of the accumulator battery.

The above-mentioned alarms shall be provided at the position, from which the ship is normally navigated.

**2.3.11** Where the automatic charging device for accumulator battery charging is used in ships in which the equipment is maintained operative by skilful maintenance and repair at sea, it shall provide at least automatic regulation of charging current. In ships where the equipment is maintained operative by means of other than skilful maintenance and repair at sea (duplication of the equipment and/or shore-based maintenance) the automatic charging device shall provide unattended charging of the accumulator batteries at sea.

**2.3.12** No failure of accumulator batteries or the battery charging device shall impair the operating capability of any radio equipment being charged from the ship's source of electrical power.

**2.3.13** If the serviceability of the equipment is ensured by its duplication on ships engaged on voyages in sea areas A1, A2 and A3, as well as A1, A2, A3 and A4, the main radio equipment fitted in accordance with Table 2.2.1 and duplicating equipment may be supplied from one reserve source of the electrical power where the automatic charging device is applied. The reserve source of electrical power shall provide power supply to the equipment during at least 1 h, and the emergency source of electrical power shall totally comply with all the relevant requirements Part XI "Electrical Equipment" of Rules for the Classification and Construction of Sea-Going Ships, as well as the requirements for power supply of radio installations contained in Table 2.3.4 of this Part of the Rules.

In case the emergency source of electrical power is not totally in line with the appropriate requirements of Part XI "Electrical Equipment" of Rules for the Classification and Construction of Sea-Going

Ships as stated above, the main radio equipment to be installed in accordance with Table 2.2.1 and the duplicating equipment shall be supplied from two independent sources of power, using their own automatic charging devices. The main radio equipment to be installed according to Table 2.2.1 shall be supplied from the reserve source of electrical power during 6 h and the duplicating equipment during 1 h.

On ships navigating in sea areas A1, as well as A1 and A2 the main radio equipment to be installed according to Table 2.2.1 and duplicating equipment, if any, may be supplied from one reserve source of electrical power, using one automatic charging device.

The reserve source of electrical power shall meet the requirements of 2.3.6 to 2.3.9.

**2.3.14** If a source of an uninterruptable power supply is used as a reserve source of electrical power the alarms required by 2.3.3 and 2.3.10 shall be activated also in case of faults in the source of the uninterruptable power supply itself.

In case of failure of the source of the uninterruptable power supply provision shall be made for connection of radio installation to the second source of the uninterruptable power supply or for the direct connection of radio installation to the main or emergency source of electrical power:

- .1 1/10 of the current consumed for transmission;
- .2 current consumed for reception;
- .3 current consumed for additional loads;
- .4 rated battery charging current.

**2.3.15** If an uninterruptable input of the ship's coordinates from the ship radio navigation system receivers as well as the data from the ship's navigation or other equipment to a radio installation required by this Section is needed to ensure its proper work, this equipment shall be supplied from the main, emergency and reserve sources of electrical power.

## 2.4 AERIALS

**2.4.1** In every ship there shall be erected the following aerials to provide the operation of the radio equipment required by 2.2.1:

.1 aerial of a VHF radiotelephone station, where necessary, aerial of a fixed two-way VHF radiotelephone apparatus for communication with aircrafts, as well as separate aerials of the main and operational VHF radiotelephone stations for ships of river-sea navigation;

.2 aerial of a VHF DSC watch receiver. It is allowed to use common aerial (except aerials of a two-way VHF radiotelephone apparatus for communications with aircrafts, as well as aerials of the

main and operational VHF radiotelephone stations for ships of river-sea navigation) provided that the independent operation of equipment specified in 2.4.1.1 and 2.4.1.2 is ensured;

**.3** aerial of a MF radiotelephone station;

**.4** aerial of a MF DSC watch receiver. It is allowed to use common aerial if it is capable to provide independent operation of the equipment specified in 2.4.1.3 and 2.4.1.4;

**.5** aerial of a MF/HF radio transmitter for radiotelephony and NBDP (MF-band aerial and HF-band aerial);

**.6** aerial of a MF/HF DSC watch receiver and MF/HF radio receiver for radiotelephony and NBDP.

It is allowed to use common aerial if it is capable to provide independent operation of the equipment specified in 2.4.1.5 and 2.4.1.6;

**.7** aerial of an INMARSAT ship earth station;

**.8** aerial of EGC receiver;

It is allowed to use common aerial if it is capable to provide independent operation of the equipment specified in 2.4.1.7 and 2.4.1.8;

**.9** aerial of a NAVTEX receiver and HF direct-printing radiotelegraph receiver for reception of MSI.

**2.4.2** As far as practicable, one common aerial shall be provided for all general broadcasting receivers fitted on board ship. The use of aerials assigned for radio communication and radionavigational facilities as aerials for general broadcasting receivers is not allowed.

## 2.5 SPARE PARTS AND SUPPLY

**2.5.1** The necessary complement of spare parts, tools, materials and measuring instruments shall be provided on every ship, irrespective of the radio equipment maintenance and repair methods.

The list and amount of spare parts for each type of the radio equipment as well as the radio equipment involving the moduli, cards, integrated circuits, etc. are subject to special consideration by the Register.

If the serviceability of the equipment fitted in accordance with 2.2.1. is ensured by its duplication, the list and amount of spare parts for each type of the radio equipment may be minimum (reference is made to 2.6.3) established by manufacturer.

**2.5.2** For wire-type MF-band aerial the spare aerial shall be provided, completely assembled for immediate erection as well as aerial wire, insulators, including piercing and rigging gear (thimbles, shackles, clamps, etc.) for a possibility of manufacturing an equivalent aerial fitted on board ship.

## 2.6 MAINTENANCE AND REPAIR OF RADIO EQUIPMENT

**2.6.1** On ships engaged in voyages in sea areas A1, as well as A1 and A2, the serviceability shall be ensured by one of the following ways: duplication of equipment, shore-based maintenance and repair or at-sea electronic maintenance and repair capability, or a combination of these.

**2.6.2** On ships engaged in voyages in sea areas A1, A2 and A3 as well as A1, A2, A3 and A4, the serviceability shall be ensured by using a combination of at least two methods such as duplication of equipment, shore-based maintenance and repair or at sea electronic maintenance and repair capability.

**2.6.3** If the serviceability of the equipment fitted in accordance with 2.2.1 is ensured by its duplication, the list of duplication intended for sea area A1 shall be included: the second VHF radio installation with DSC watch receiver, for sea areas A1 and A2, in addition to the list of equipment, the second MF radio installation or INMARSAT ship earth station (subject to sea areas and under RS consideration).

Installation of INMARSAT ship earth station shall not relieve ships of having the DSC watch receivers on 2187,5 kHz among the radio equipment while navigating in sea areas A1, A2.

The scope of duplication for sea areas A1, A2 and A3, as well as A1, A2, A3 and A4 is given in Table 2.6.3.

**2.6.4** All duplicating equipment shall be connected to the separate aerials, to the main, emergency and reserve power sources and be ready for the immediate use.

**2.6.5** If the serviceability of the equipment fitted in compliance with 2.2.1 is ensured by the shore-based maintenance and repair, there shall be on board the agreement for these services with the equipment manufacturer or with the works authorized for those by the manufacturer or a written declaration/ plan showing how shore-based maintenance is to be carried out. In addition, in sea areas where ships are engaged in voyages, the opportunity for equipment maintenance and repair shall be provided.

Shore-based maintenance centres shall be recognized by the Register.

**2.6.6** In the shore-based maintenance centers and in organizations engaged in on board installation of radio equipment the radio operators shall be properly instructed on how to use the installed radio equipment and familiarized with the maintenance and repair principles prior to putting the equipment in operation.

**2.6.7** If the serviceability of the equipment fitted in compliance with 2.2.1 is ensured by at sea electronic maintenance and repair, these services shall be provided by the radio operator holding a relevant Certificate of Competence.

**2.6.8** All the ships engaged on voyages in sea areas A1, A2 and A3, as well as A1, A2, A3 and A4, irrespective of the radio equipment maintenance and repair methods, shall always have on board:

**.1** specifications and users manuals for all radio equipment and battery chargers in English (Russian);

**.2** specifications and battery capacity calculations for the installed batteries;

**.3** antenna arrangement drawings (plan and profile);

**.4** radio arrangement drawings (at least in two views);

**.5** wiring diagram.

Technical documentation specified in items 3, 4 and 5 shall be corrected for compliance with all the amendments introduced during operation of the ship and approved by the Register;

**.6** Tools, instruments and spare parts for all radio equipment complying with the specified maintenance method (s);

**.7** International guidelines (ITU edition):

List of coast stations (list IV) – List of shore-based stations,

List of ship station (list V) – List of ship stations,

List of radiodetermination and special service stations (list VI) – List of radio determination and special service stations,

List of call sign and numerical identities (list VIIA) – List of call sign and numerical identities used in the Maritime Mobile and the Maritime Mobile Satellite Services.

The amount of technical documentation, tools, instruments and spare parts shall be approved by the Register.

**2.6.9** On ships engaged on voyages in sea areas A1, A2 and A3, as well as A1, A2, A3 and A4, if serviceability of the radio equipment is ensured by a combination of methods, including the skillful maintenance and repair at sea, then the relevant additional technical documentation, tools, instruments and spare parts shall be available on board to enable maintenance, surveys and detection and elimination of any faults. The amount of additional technical documentation, tools, instruments and spare parts to be kept on board shall comply with the installed equipment and be approved by the Register.

**2.6.10** On ships engaged on voyages in sea areas A1 or A1 and A2 the amount of technical documentation, tools, instruments and spare parts shall be approved by the Register and determined based on the requirements of 2.6.8 and 2.6.9, depending on the operating conditions of the ship, composition of radio equipment and methods of its maintenance and repair.

**2.6.11** On all the ships radio communication in distress and for safety shall be ensured by the skillful radio operators. These operators shall hold relevant Certificates of Competence; any of them may be assigned responsible for radio communication in distress.

**2.6.12** A ship station radio license issued in accordance with established procedure shall be available on all ships.

## 2.7 DOCUMENTING (RADIO LOG)

**2.7.1** On all the ships provision shall be made for a radio log for registration of all events (with indication of date and time) relevant to radio exchange in distress, urgency or safety and are of high importance for the protection of human life at sea, as well as the records related to operation of the ship station.

Table 2.6.3

| Nos      | Duplicating radio equipment                    | A1, A2 and A3 sea areas | A1, A2, A3 and A4 sea areas |
|----------|--|-------------------------|-----------------------------|
| <b>1</b> | VHF radio installation:                        |                         |                             |
|          | DSC encoder                                    | 1                       | 1                           |
| <b>2</b> | radiotelephone station                         | 1                       | 1                           |
|          | MF/HF radio installation <sup>1</sup> :        |                         |                             |
|          | DSC encoder                                    | 1                       | 1                           |
|          | DSC watch receiver                             | 1                       | 1                           |
|          | radio receiver for telephony and NBDP          | 1                       | 1                           |
|          | radio transmitter for telephony, DSC and NBDP  | 1                       | 1                           |
|          | direct-printing apparatus of improved fidelity | 1                       | 1                           |
| <b>3</b> | terminal printing device                       | 1                       | 1                           |
|          | INMARSAT ship earth station                    | 1 <sup>2</sup>          | 1 <sup>2, 3</sup>           |

<sup>1</sup>It is not required on ships making voyages in sea areas A1, A2 and A3 if INMARSAT ship earth station is fitted as a backup equipment.

<sup>2</sup>It is not required if MF/HF radio installation is fitted as a backup equipment.

<sup>3</sup>For ships engaged only episodically on voyages in sea area A4 and fitted with MF/HF radio installation, backup MF/HF radio installation may be replaced by INMARSAT ship earth station.

### 3 SPACES FOR RADIO EQUIPMENT, ITS ARRANGEMENT, CABLING

#### 3.1 GENERAL

**3.1.1** Every radio installation shall:

**.1** be so located that no harmful interference of mechanical, electrical or other origin affects its proper use, and so as to ensure electromagnetic compatibility and avoidance of harmful interaction of radio installation with other equipment and systems;

**.2** be so located as to ensure the greatest possible degree of safety and operational reliability;

**.3** be protected against harmful effects of water, extremes of temperature and other adverse environmental conditions.

**.4** be provided with safe and uninterruptable illumination, independent from the main and reserve source of electrical power intended for sufficient illumination of the radio installation controls;

**.5** be placed considering the safe distance from magnetic compass.

**3.1.2** To comply with the requirements for radio equipment arrangement, provision shall be made for a workstation for radio communication complying with the rule requirements for the bridge design, equipment arrangement and bridge procedures set forth in Appendix to Part V «Navigational Equipment» of the present Rules or a special space for radio equipment (radio room) with remote controls of the equipment installed in the navigating bridge on all ships.

Provision shall also be made for special spaces intended for arrangement of command broadcasting centre, if command broadcasting facilities are required by 2.2.1, and for the accumulator batteries of the reserve source of electrical power.

In some ships where it is impossible to provide a command broadcast centre the arrangement of the equipment for command broadcast facilities is allowed on the navigating bridge.

At location of the equipment of command broadcasting facilities the illumination complying with 2.3.4 shall be provided.

In some ships where it is impossible to provide a separate accumulator battery room, it is allowed to arrange accumulator batteries in accumulator battery boxes (cabinets) provided the requirements specified in 3.3 are observed.

**3.1.3** All radio equipment shall be so located in a ship that its operational efficiency is in no way impeded by the ship being submerged to the level of the deck where it is arranged.

**3.1.4** All ship spaces intended for installation of radio receiving and transmitting apparatus shall have metal or metal-coated bulkheads. Ceilings and decks

shall be electrically connected with one another and to the hull of a ship, with continuity of screening being preserved. In non-metal ships the screening metal sheathing shall be electrically connected to a keel plate or to specially made earthing arrangement.

**3.1.5** All radio equipment shall be so installed that it is readily accessible for maintenance and repair on board ship. Radio equipment shall be securely fastened and shall not shift notwithstanding the angles of heel and trim of the ship or severe bumps and shaking likely to occur under service conditions.

#### 3.2 SPECIAL SPACE FOR ARRANGEMENT OF RADIO EQUIPMENT (RADIROOM)

**3.2.1** In ships on which radioroom is provided it shall be located on the navigating bridge deck in close proximity to the place from which the ship is normally navigated.

It is not allowed to locate the radioroom in an explosive area.

**3.2.2** The position of a radioroom aboard ship shall, as far as practicable, provide for:

**.1** direct outside lead-in of the aerials;

**.2** minimum length of cables leading to the accumulator battery room and navigating bridge;

**.3** maximum distance of aerial from large metal objects (funnels, masts, ventilators, etc.);

**.4** maximum distance of the radioroom from electrical devices and networks;

**.5** maximum distance of the radioroom from installations and compartments causing noise (winches, cranes, ventilators, exhaust pipes, coal loading trunks, shops, etc.);

**.6** maximum distance of the radioroom from compartments and objects evolving a considerable amount of heat (galley, bakeries, steam pipes, etc.);

**.7** most favourable conditions for spacing radio equipment;

**.8** most favourable conditions for normal work and safety of operating personnel.

**3.2.3** The radioroom shall be such as to give no access into any other compartments bearing no relation to radio equipment and exclude any possibility of the radioroom being used as a permanent living compartment. The chief radio officer's cabin shall be adjacent to the radioroom. If the fulfilment of this requirement is impracticable, it is allowed to locate the cabin not more than 20 m from the radioroom and not lower than one deck below.



**3.2.4** The total floor space of the radioroom shall be not less than twice as large as the floor space occupied by the radio equipment and furniture together, and the clear height of the radioroom shall be not less than 2 m.

**3.2.5** Bulkheads, ceilings and, if required, doors of the radioroom shall be lined from the inside with sound and heat-resistant insulating materials and sheathed with electroinsulating materials. The floor of the radioroom shall be covered with insulating material.

**3.2.6** The mechanical noise level in the radioroom under service conditions shall not exceed 60 dB.

**3.2.7** There shall be two exits in the radioroom: one leading directly to the open deck and the other to the interior spaces of a ship.

If there is no direct exit to the open deck, the provision shall be made for two means of access to and exit from the radioroom, one of which can be an illuminator or a window of sufficient dimensions or another means approved by the Register.

**3.2.8** The radioroom shall be fitted with electric heating appliances in addition to the air conditioning system provided, capable of maintaining the inside temperature within the range from +18 to +23° C during cold seasons.

**3.2.9** The radioroom shall be fitted with efficient ventilation system capable of providing reliable operation of the radio equipment under all service conditions.

**3.2.10** The radioroom shall be provided with adequate natural and artificial lighting. The main lighting shall comply with the requirements specified in Part XI "Electrical Equipment" of Rules for the Classification and Construction of Sea-Going Ships. The emergency lighting shall be supplied from the reserve source of electrical power of the radio equipment and shall provide for an illumination intensity of not less than 50 lx on the clock dials (or supply of electronic clock) and on controls for operating the radio communication equipment providing radio exchange in distress and for safety. The use of luminescent lamps is subject to special consideration by the Register.

**3.2.11** Two-way switches shall be fitted in two places for switching on and off the lighting from the reserve source of electrical power. One switch shall be fitted at the main exit out of the radioroom and the other switch at the operating position of the radio operator. The switches shall operate independently of each other. Each switch shall be provided with clear marking designating its purpose. The fitting of a switch at the operating position of the radio operator is not obligatory if the operating position is situated in close proximity to the main exit.

**3.2.12** Laying of transit electric cables and wires as well as transit pipelines through the radioroom is not allowed.

**3.2.13** The radioroom shall be provided with sufficient number of plug sockets connected to the ship's source of electrical power.

**3.2.14** The radioroom shall be provided with an efficient two-way system of calling and voice communication with the navigating bridge independent of all other communication systems of the ship and capable of providing possibility for talks only between these two points.

**3.2.15** If the ship is fitted with an automatic telephone station, the radioroom and the cabin of a radio operator shall be provided with telephone sets.

**3.2.16** The radioroom shall be provided with the furniture and equipment as follows: operating table, working chair secured on the deck, divan, marine clock with a second-hand or electronic clock, a signal lamp of the alarm bells, cabinet for storing spare parts and supplies.

**3.1.17** The clock mounted in the radioroom shall provide the indication of hours, minutes and seconds clearly distinguished from the operating position of the radio operator under any lighting conditions.

**3.2.18** The plate with the call sign of the ship, the ship station identity and other codes as applicable for the use in the radio installation shall be posted up in a prominent place in a radioroom.

### 3.3 ACCUMULATOR BATTERY ROOM

**3.3.1** The accumulator battery room which is intended for installation of the accumulator batteries used for feeding the reserve source of electrical power, shall be located on or above the navigating bridge deck level in such a place that the length of cables leading to radio equipment does not exceed 15m. The accumulator battery room shall be provided with an exit to the open deck of the ship.

**3.3.2** The construction of the accumulator battery room as well as its systems of heating and ventilation shall comply with the requirements specified in Part VIII "Systems and Piping" and in Part XI "Electrical Equipment" of Rules for the Classification and Construction of Sea-Going Ships.

**3.3.3** The accumulator battery room shall be provided with electric lighting complying with the requirements specified in Part XI "Electrical Equipment" of Rules for the Classification and Construction of Sea-Going Ships.

**3.3.4** The installation of the accumulator batteries, not relating to the radio equipment, in the accumulator battery room is allowed only if it causes no radio interference.

**3.3.5** The accumulator battery room shall be provided with racks for placing accumulator

batteries and sectional recess for storing distilled water and electrolyte. The top surface of the first row rack shall be at least 100 mm above the deck. The arrangement of accumulator batteries shall comply with the requirements set forth in Part XI "Electrical Equipment" of Rules for the Classification and Construction of Sea-Going Ships.

**3.3.6** Degree of protection of accumulator battery boxes (cabinets) installed on the open deck of the ship shall not be below IP56 and placed at a height of at least 100 mm above the deck.

The design, heating and ventilation systems of accumulator battery boxes shall comply with the requirements specified in Part VIII "Systems and Piping" and Part XI "Electrical Equipment" of Rules for the Classification and Construction of Sea-Going Ships.

**3.3.7** The accumulator batteries shall be electrically insulated from the ship's hull.

**3.3.8** The accumulator batteries shall be so located and installed as to ensure:

- .1 the highest degree of service;
- .2 a reasonable lifetime;
- .3 a reasonable safety;
- .4 that when charged to the rated capacity, the accumulator batteries will provide the hours of operation required by the present Part under all weather conditions.

**3.3.9** The accumulator battery temperature shall remain within the manufacturer's specifications whether under charge, discharge or idle.

#### **3.4 ARRANGEMENT OF RADIO EQUIPMENT ON NAVIGATING BRIDGE**

**3.4.1** The workstation intended for installation of radio equipment in compliance with 3.1.2 shall be located in the aft of the navigating bridge so that the watch officer assistants have an over all view of the navigation while operating the radio equipment.

If the workstation and the rest of the navigating bridge are separated by a bulkhead, it shall be made of glass or fitted with windows.

There should be no lockable door between the workstation and the navigating bridge.

When the work station is being used during night-time, a curtain separating it from the rest part of the navigating bridge shall be provided in order to avoid dazzling effect from the lights to the watch-keeping personnel and the pilot.

The radio work station shall be provided with the furniture and equipment as follows: operating table, the clock complying with the requirements of 3.2.17, working chair secured on the deck as well as the main lighting and lighting from the reserve source of power.

**3.4.2** The radio equipment shall be so arranged and installed that the magnetic field produced by it will not influence the ship magnetic compass readings in compliance with 5.1.47.

**3.4.3** Radio equipment fitted on the navigating bridge as an additional equipment shall be so arranged that its functioning or technical condition could not adversely affect normal operation or cause failure of radio, navigational or other equipment required by the Rules.

**3.4.4** The VHF radio installation with the controls of the radiotelephone channels as well as those providing generation and transmission of the distress and safety alert in the DSC and radiotelephony mode shall be located forward of the navigating bridge near the radar display station so that immediate access and priority is possible at all times, if additional control units are provided, and while using them the operator shall face the ship's bow.

When there is more than one control unit, indication shall be given to the other units that the radio station is in operation.

Where necessary, facilities for radio communications from the wings of the navigating bridge shall be provided. Portable VHP radio equipment may be used to meet the latter requirement.

**3.4.5** The MF radio installation with controls providing generation and transmission of the distress alert in the DSC and radiotelephony mode, as well as communication in distress and for safety in the radiotelephony mode shall be located at workstation for radio communication.

**3.4.6** The MF/HF radio installation with controls providing generation and transmission of the distress alert in the DSC mode as well as communication in distress and for safety in the radiotelephony and NBDP modes shall be located at workstation for radio communication.

**3.4.7** The INMARSAT ship earth station with the controls providing transmission of the distress alert and communication in distress as well as providing the safety in the telephony mode or in the data transmission mode shall be located at workstation for radio communication.

**3.4.8** The VHF, MF, MF/HF-radio installations and the INMARSAT ship earth station with the controls providing generation and transmission of the distress alert as well as communication in distress and for safety (see 3.4.4., 3.4.5, 3.4.6, 3.4.7), fitted for duplication, shall be located at workstation for radio communication.

**3.4.9** If the radioroom is provided, then after transmission the distress alert from workstation for radio communication in compliance with 3.4.5, 3.4.6 and 3.4.7, the radio communication in distress and for safety may be performed from the radioroom.

**3.4.10** The COSPAS-SARSAT satellite EPIRB shall be located in compliance with the requirements of 3.6 and Table 2.2.1.

**3.4.11** NAVTEX service, EGC, INMARSAT receivers as well as HF NBDP receiver for reception of MSI shall be located at workstation for radio communication and shall be capable of providing light and audible signalling system in case of reception of distress or urgent messages or those having distress category.

**3.4.12** The plate with the call sign of the ship, the ship station identity and other codes as applicable for the use of the radio equipment shall be posted up in close proximity to the controls of radio installations providing transmission of the distress alert as well as communication in distress and for safety.

**3.4.13** Illuminating lamps built in the radio equipment and intended for the arrangement on the navigating bridge shall be provided with luminous intensity control facilities.

**3.4.14** The following requirements shall be complied with on passenger ships:

**.1** the distress panel shall be located at workstation for radio communication. This panel shall have either one button which activates transmission of the distress alert by all radio installations intended for that purpose on board, or one button for every separate radio installation. There shall be clear visual indication on that panel that the button or buttons were pushed.

The button or buttons shall be protected against inadvertent operation.

When the COSPAS-SARSAT satellite EPIRB is used as the second independent means of distress alert transmission and not provided with remote activation, provision shall be made for the additional COSPAS-SARSAT system EPIRB placed in close proximity to workstation for radio communication (see 3.6.1);

**.2** the relevant radio communication equipment shall be continuously and automatically provided with the ship's position data for inclusion in the original distress message when the button or buttons on the panel initiating a distress alert are pushed;

**.3** panel signalling a distress alert shall be installed at the position, from which the ship is normally navigated. The panel initiating a distress alert shall be provided with visual and audible warning to indicate receipt of any distress alert, as well as indication of the radio service, via which the distress alert was received.

**3.4.15** To comply with the Rule requirements for passenger ships with regard to transmitting ship-to-shore distress alerts by at least two separate and independent means, when connecting the radio equipment to the distress panel, one shall follow the requirements set out in Table 3.4.15.

Table 3.4.15

| Sea areas                 | Radio equipment  |
|---------------------------|--|
| A1                        | VHF radio installation, a VHF EPIRB or a COSPAS-SARSAT satellite EPIRB   |
| A1 and A2                 | VHF radio installation, MF radio installation, a COSPAS-SARSAT satellite EPIRB                                 |
| A1, A2 and A3 (variant 1) | VHF radio installation, MF radio installation, INMARSAT ship earth station, a COSPAS-SARSAT satellite EPIRB    |
| A1, A2 and A3 (variant 2) | VHF radio installation, MF/HF radio installation, a COSPAS-SARSAT satellite EPIRB                              |
| A1, A2, A3 and A4         | VHF radio installation, MF/HF radio installation, INMARSAT ship earth station, a COSPAS-SARSAT satellite EPIRB |

**3.4.16** Radio equipment installed for duplication on ships engaged on voyages in sea areas A1, A2 and A3, as well as A1, A2, A3 and A4 does not need to be connected to the distress panel, if this equipment transmits the distress alert and is installed in close proximity to the panel.

**3.4.17** An audible and light signalling system shall be provided in order to indicate reception of distress or urgency calls, or a call having distress category, as well as those not being urgency or distress calls. The signalling system shall be non-disconnectable. Provision shall be made for manual acknowledgement of signals. Possibility of checking the audible and light signalling system shall be provided.

**3.4.18** DSC operation procedures should be posted near the DSC equipment on the navigation bridge. Emergency procedures should be posted near the relevant equipment on the bridge.

"GMDSS operating guidance for masters of ships in distress situations" and the procedure "False alerts", both drawn up by IMO, should be posted on the navigation bridge.

### 3.5 ARRANGEMENT OF TWO-WAY VHF RADIOTELEPHONE APPARATUS AND TWO-WAY VHF RADIOTELEPHONE APPARATUS INTENDED FOR COMMUNICATIONS WITH AIRCRAFTS

**3.5.1** The two-way VHF radiotelephone apparatus shall be kept in the navigating bridge or in any other compartment which is kept unlocked while the ship is at sea, if such compartment provides quicker and more convenient transfer of the apparatus to any lifeboat or any liferaft.

The apparatus shall be kept at a prominent place. All fastenings, if any, intended for securing the apparatus at the place of storage shall be designed for urgent releasing without applying tools.

A clearly visible symbol complying with the requirements of Part II "Life-Saving Appliances"

shall be fitted near each position where the two-way VHF radiotelephone apparatus is located.

**3.5.2** The two-way VHF radiotelephone apparatus intended for communication with aircrafts shall be kept in the navigating bridge at a prominent place.

**3.5.3** The stationary two-way VHF radiotelephone apparatus intended for communication with aircrafts shall be located in the navigating bridge at a prominent place.

### **3.6 LOCATION OF EMERGENCY POSITION-INDICATING RADIO BEACONS**

**3.6.1** A COSPAS-SARSAT satellite emergency position-indicating radio beacon (EPIRB) intended as the second independent mean of distress alert transmission (see 2.2.1) and not provided with remote activation shall be installed in close proximity to the workstation for radio communication on the navigating bridge so that immediate access is possible at all times for initiating the distress alert as well as it shall be manually released and easily placed in any lifeboat or liferaft by a single person.

**3.6.2** A free floating COSPAS-SARSAT satellite EPIRB or a VHF EPIRB intended for installation in the ship shall be stowed on the open deck of the ship so that it does not move during ship's extreme conditions and floats free in case of sinking of the ship (see Section 13). Meanwhile, an immediate access shall be arranged for manual release and initiating the distress alert and possibility of fast and easy placement in any lifeboat or liferaft by a single person.

**3.6.3** At any place of EPIRB installation the highly visible symbol marked in accordance with the requirements of Part II "Life-Saving Appliances" shall be provided.

### **3.7 LOCATION OF RADAR TRANSPONDERS**

**3.7.1** Location of radar transponders shall be in compliance with the requirements of Part II "Life-Saving Appliances".

**3.7.2** At any place of installation of radar transponder the highly visible symbol marked in accordance with the requirements of Part II "Life-Saving Appliances" shall be provided.

### **3.8 ARRANGEMENT OF EQUIPMENT AND CABLING OF PUBLIC ADDRESS SYSTEM**

**3.8.1** Public address system shall be capable of relaying command broadcasts from the command

microphone posts to all accommodation and public spaces as well as to the open decks of the ship.

Measures shall be provided in the public address system to prevent electrical and acoustic feedback or other interference.

**3.8.2** The main command microphone post and the amplifiers of the public address system, as well as general radio broadcast receivers, record players and sound-recording apparatus relating to the post shall be installed in a special room — the command broadcast centre (see 3.1.2).

**3.8.3** Heating, lighting and ventilation of the ship command broadcast centre shall comply with the similar requirements specified for the radioroom.

**3.8.4** Every passenger ship shall be provided with at least three main broadcasting lines each of them shall have at least two loops of flame-retarding cable, sufficiently removed along the whole length and connected to two separate and independent amplifiers:

**.1** deck line intended for operating loudspeakers installed on the open decks of the ship;

**.2** service line intended for operating loudspeakers fitted in service, accommodation and public spaces of the ship's crew (cabins, messrooms, dining rooms, libraries, reading rooms, etc., including corridors and platforms adjacent to these compartments);

**.3** passenger line intended for operating loudspeakers fitted in passenger accommodation and public spaces (cabins, dining rooms, libraries, reading rooms, restaurants, saloons, verandahs, bars etc., including corridors and platforms adjacent to these compartments).

In enclosed spaces, cables and wires of command broadcast apparatus shall, as far as possible, run clear of galleys, laundries, machinery spaces of category "A" and other enclosed spaces of high fire risk, if not intended for these spaces.

Cables shall be laid so as to prevent their failure caused by bulkhead heating due to the fire in adjacent spaces.

All areas of each fire zone shall be provided with cabling of at least two loops sufficiently removed along the whole length and connected to two separate and independent amplifiers installed in different fire zones.

**3.8.5** Every cargo ship shall be provided with the broadcasting lines specified in 3.8.4.1 and 3.8.4.2.

**3.8.6** Every passenger ship shall be provided with at least two remote command broadcast microphone posts. One post shall be fitted on the navigating bridge and the other in the room intended for keeping watch while the ship is in harbour. In ships not provided with special rooms for watch keeping, the second command broadcast microphone post shall be fitted in the most convenient place close to the gangway ladder.

**3.8.7** Measures shall be taken to avoid the disfunctioning of broadcasting line in case of short-circuiting in the loudspeaker branch (see also Part II "Life-Saving Appliances" of the Rules and Part XI "Electrical Equipment" of Rules for the Classification and Construction of Sea-Going Ships).

### 3.9 CABLING

**3.9.1** All cabling of the radio equipment and protection measures against radio interference caused by the ship's electrical installations shall comply with the requirements specified in Part XI "Electrical Equipment" of Rules for the Classification and Construction of Sea-Going Ships as well as with additions and amendments set forth in the present Chapter.

**3.9.2** The protection measures against radio interference caused by the ship's electrical devices fitted with means of protection according to the requirements of Part XI "Electrical Equipment" of Rules for the Classification and Construction of Sea-Going Ships shall provide for such reception conditions that switching on and operating of such devices shall not increase the output voltage of each receiver by more than 20 per cent of the voltage value caused by internal noises.

**3.9.3** Radio equipment shall be supplied from the distribution board of the radio station in compliance with the requirements of Part XI "Electrical Equipment" of Rules for the Classification and Construction of Sea-Going Ships.

The distribution board of the radio station shall be supplied from the main distribution board and from emergency distribution board by two independent feeders.

The distribution board of the radio station shall be provided with the switching and protective equipment for connection and protection of the appropriate radio equipment in each outgoing feeder.

Connection of any consumers not relating to the radio equipment to the radioroom feeder is not allowed.

**3.9.4** The space intended for radio equipment shall be provided with a light indicator or measuring instrument for continuous checking of the ship's mains voltage.

**3.9.5** All cabling included into the cabling network of shipboard radio communication facilities and public address system shall be made by means of screened cables, with continuity of screening being preserved.

**3.9.6** All cabling in the compartments equipped with shipboard radio communication facilities and radionavigational facilities shall be made by means of screened cables, with continuity of screening being preserved. It is not allowed to use at such places any radio equipment and electrical devices without adequate screening.

The armour of cables shall be earthed at those places where the cables enter the ship spaces in which radio-receiving apparatus is installed.

**3.9.7** Metal cases of radio apparatus shall be electrically connected to the ship's hull as directly as possible. The screening armour of cables, where the cables enter the equipment, shall be electrically connected to the cases of the equipment.

**3.9.8** The coaxial cables shall comply with the following requirements:

**.1** coaxial cables shall be fitted in separate cable runs laid at least 10 cm away from power cables;

**.2** crossing of cables shall be done at right angles (90°);

**.3** where there is one bend in one place, bending radius shall exceed external diameter of the cable 5 times;

**.4** where there are several bends in one place, bending radius shall exceed external diameter of the cable 10 times;

**.5** where flexible cables are used, bending radius shall exceed external diameter of the cable 20 times.

Coaxial cables in cargo holds, on the open deck and on masts shall be laid in compliance with the requirements of Part XI "Electrical Equipment" of Rules for the Classification and Construction of Sea-Going Ships.

**3.9.9** In cabling connecting panels for remote transmission of distress alert, DSC encoders, structurally made as separate units, plug connectors shall not be used.

**3.9.10** Insulation resistance of every laid cable disconnected at both ends from the radio equipment shall not be less than 20 Mohm, irrespective of the cable length.

## 4 AERIALS AND EARTHING

### 4.1 GENERAL

**4.1.1** It is allowed to fit a ship with an aerial of any type which provides the highest operational efficiency of the radio equipment in accordance with its purpose.

Aerials shall be capable of withstanding the effects of mechanical and climatic factors encountered under the ship's service conditions.

**4.1.2** All ship aerials shall be capable of withstanding a pressure of air flow having speed of 60 m/s in any directions, the ship's speed and other factors being not considered.

**4.1.3** Wire aerials shall be manufactured of flexible stranded aerial wire made of copper or copper-based alloy. To satisfy the requirements of 4.1.2, when calculating the minimum diameter of the aerial wire, the aerial sag shall be taken as equal to 6 per cent of the aerial span.

**4.1.4** Each horizontal aerial wire shall be made of one-piece stranded wire. Where the construction of the aerial does not permit to make the down-lead and the corresponding horizontal aerial of one-piece wire, the connection of the horizontal aerial wire with the down-lead shall be made by means of splicing or by means of compression couplings providing the reliable electrical contact.

**4.1.5** For the purpose of increasing durable and reliable operation of wire T-type aerial, the main mechanical load of its down-lead shall not apply directly to the place of the down-lead connection with the horizontal wire.

It is recommended to apply this requirement during the assembling of F-type aerials.

**4.1.6** The down-lead wire of an aerial shall be secured at the lead-in to a guy fitted with insulators; then the down-lead wire shall be connected to the lead-in by means of copper or brass thimble. The connection of the thimble with the down-lead wire shall be effected by soldering or cold pressing.

**4.1.7** The aerial rigging shall ensure the possibility for quick lowering and hoisting as well as tension regulation of the wire aerial without man hoisting to the mast tops.

**4.1.8** As far as is practicable, every wire of multiwire aerial shall be capable of being hoisted and lowered separately. The span between the wires shall not be less than 700 mm.

**4.1.9** Halyards used for hoisting wire aerials shall be flexible halyards made of the material approved by the Register. Hoisting halyards used in ships carrying readily flammable cargoes shall be made of non-combustible materials and their securing positions

shall be outside a dangerous space. If steel halyards are used in this case, they shall be reliably electrically connected to the ship's hull.

**4.1.10** Special high frequency insulators rated for corresponding operational voltage and mechanical load shall be used for the aerial insulation.

**4.1.11** The aerial insulation resistance in relation to the ship's hull under normal climatic conditions shall not be less than 10 Mohm, and under excessive humidity, not less than 1 Mohm.

**4.1.12** Mast-type aerials and aerials of other types consisting of some separate conducting units shall be so constructed that the value of contact resistance of any electrical connection does not change under the influence of mechanical loads and climatic factors encountered under service conditions.

**4.1.13** The transmitting aerials shall be designed for operation of any transmitter connected to them at maximum values of its output power and impressed voltage.

**4.1.14** The receiving aerials shall be so constructed and arranged that their interaction with all transmitting aerials and with one another is minimum.

**4.1.15** Individual lengths of the horizontal and down-lead wires of the aerials shall be located at a distance not less than 1 m from funnels, masts and other metal objects of the ship. The aerials shall be arranged so as to prevent touching the metal structures of the ship under any service conditions.

**4.1.16** Separate elements of the mast-type aerials such as wires, pins and insulators shall be easily replaceable.

It is recommended to provide the collapsible mast-type aerials.

**4.1.17** The aerials of general radio broadcasting and television receivers shall be arranged as far apart from all service purpose aerials as possible.

**4.1.18** If the portable VHF radiotelephone station for service interior communications is stationary mounted, its aerial height shall not exceed 3,5 m above the navigating bridge deck.

**4.1.19** In oil tankers and oil recovery vessels, gas carriers and chemical carriers all steel rigging of masts (shrouds, stays, whistle/tyfon, etc.) shall be broken up with insulators. The distance between the insulators shall be not more than 6 m, and the lowest insulator shall be not less than 3 and not more than 4 m from the deck. It is recommended to break up the rigging of every ship with insulators in order to minimize power losses while operating transmitters.

**4.1.20** The lower ends of the standing steel rigging of masts and funnels shall be electrically

connected to the ship's hull in compliance with the requirements specified in 4.8.8. All other rigging shall be insulated from the ship's hull or, if the fulfilment of this requirement is impracticable, shall be reliably electrically connected to the ship's hull by means of bronze or steel stranded wire of the adequate crosssection.

#### 4.2 MF AND MF/HF AERIAL

**4.2.1** The aerial shall provide the possibility of tuning transmitters to any frequency of the required frequency range, and the necessary radio communication. The receiving aerials may be of any type complying with the requirements of the Rules.

**4.2.2** The wire T- or R-type aerial shall be provided with means for its quick replacement by a spare aerial and shall have a device capable of preventing an aerial break caused by severe mechanical tension, for example, it may be a safety loop with a mechanical safety device fitted in the aerial halyard. The breaking force of the mechanical safety device shall be equal to not more than 0,3 of the breaking force of the aerial wire. The mechanical safety device shall be capable of ensuring sufficient slackening of the aerial tension, simultaneously preventing the aerial from touching superstructures, rigging and the ship's hull.

A device capable of preventing an aerial break need not be provided if the aerial length is not over 25 m and the aerial is suspended between the supports not subjected to the abrupt vibrations.

#### 4.3 VHF-AERIAL

**4.3.1** The VHF-aerial shall have a vertical polarization and be placed in a position which is as elevated and free as possible, with at least 2 metres horizontal separation from constructions.

**4.3.2** The VHF-aerial shall be fitted at the maximum possible height so as to ensure effective radiation and reception of signals at all operating frequencies.

#### 4.4 GENERAL REQUIREMENTS TO ANTENNA SYSTEM OF INMARSAT SHIP EARTH STATION

**4.4.1** Antenna system shall be placed in a position which is as elevated as possible from other purpose aerials and at places of the lowest vibration.

It shall be installed at readily accessible place.

**4.4.2** The sitting of the antenna system shall be so selected as to provide constant satellite tracking in all directions at positive angles up to  $-5^\circ$  relative to the horizon plane. Antenna system shall be installed at the top of the radar mast or at the mast specially installed for this purpose.

For directional antenna system measures shall be taken to avoid shadow sectors of greater than  $6^\circ$  caused by ship structures within a radius of 10 m from the antenna.

For nondirectional antenna system measures shall be taken to avoid shadow sectors of greater than  $2^\circ$  caused by ship structures within a radius of 1m from the antenna.

**4.4.3** Antenna system shall not be installed on the same level as the radar aerial.

**4.4.4** When installing the antenna system the following safe distances to other purpose aerials and magnetic compass shall be provided for:

- .1 to HF-aerial — more than 5 m;
- .2 to VHF aerial — more than 4 m;
- .3 to magnetic compass — more than 3 m.

#### 4.5 ANTENNA SYSTEM OF INMARSAT-C SHIP EARTH STATION AND EGC RECEIVER

**4.5.1** Antenna system shall be so installed as to avoid shadow sectors impairing the performance of equipment in the bow and the stem direction of the ship up to  $-5^\circ$  and in the starboard and port directions up to  $-15^\circ$  relative to the horizontal plane.

**4.5.2** When installing two antenna systems of INMARSAT-C ship earth station the vertical distance between them shall be not less than 1 m.

#### 4.6 LEAD-IN AND INTERIOR WIRING OF AERIALS

**4.6.1** Wiring of the transmitting aerials into interior spaces of the ship shall be effected through special lead-in fitted with insulators capable of withstanding the corresponding operational voltage, except when the interior wiring of an aerial is made by means of an coaxial cable.

**4.6.2** The construction of the lead-in of the transmitting aerial shall provide for the possibility of easy and ready connection and disconnection of the aerial, preferably, without applying any tools. The construction of the lead-in shall exclude any possibility of the corona-effect during the operation of the transmitter.

**4.6.3** The leads-in of the transmitting aerials shall be, preferably, fitted at such places where they provide for the shortest possible run of aerial wiring

in interior compartments from the lead-in to transmitters. When installed at readily accessible place, the lead-in and the aerial connected thereto shall be completely guarded against the possibility of accidental touching within 1800 mm above the appropriate deck, a stairway (ladder) or any other place where people may be present. When installing the protection casings or using the hollow mast-type aerials the provision shall be made for removing the condensate from the inner cavities of the structure.

**4.6.4** To eliminate energy losses, it is recommended to use precaution guards made of insulating materials. If metal precaution guards are used, they shall be reliably earthed to the ship's hull. The precaution guard shall not cause a dead angle for visual bearing taking.

**4.6.5** Feeders of transmitting MF-aerials, laid in interior compartments, shall be, preferably, as short as possible.

**4.6.6** Feeders of transmitting aerials shall be screened; the aerial switches (commutators) shall be of a screened type.

**4.6.7** Feeders of the receiving aerials shall be made with coaxial screened cables, with continuity of screening being preserved. In this case, all commutators, change-over switches, lightning arresters and other devices connected to such cables shall be of a screen type. Feeders shall not induce signal attenuation over 3 dB.

**4.6.8** The coaxial screened cables of the feeders of receiving aerials shall be led directly to the open deck and connected to the receiving aerials at the sufficient height. This connection shall be made by means of special contact device of waterproof or hermetic design, providing for reliable electrical connection and access for control over its condition.

**4.6.9** Every aerial not intended for constant switching to operational position shall be provided with a special commutating device fitted inside the compartment and capable of switching the aerial into operational, isolated and earthed positions.

**4.6.10** Every receiving aerial shall be provided with a special device capable of protecting the receiver lead-in against atmospheric discharges.

**4.6.11** If the matching system or the devices capable of protecting against atmospheric discharges are fitted between the receiving aerial and coaxial cable, they shall be connected on the aerial side.

#### 4.7 EARTHING

**4.7.1** Operational (high-frequency) earthing intended for ensuring normal operation of shipboard transmitters installed in the radioroom shall be made

with the help of a copper busbar and shall run as directly as possible from the aerial commutator to a metal bulkhead or deck reliably electrically connected to the ship's hull. The busbar shall have tappings leading to the earthing terminals of transmitters. The length of the bus-bar from the transmitter to the place where connection with the bulkhead or deck is effected shall not exceed 1000 mm. Depending upon the power of transmitters, the sectional area of busbars and tappings shall be not below values indicated in Table 4.7.1.

Table 4.7.1

| Power of transmitter, W | Busbar sectional area, mm <sup>2</sup> |
|-------------------------|--|
| Below 50                | 25                                     |
| 50 — 500                | 50                                     |
| Above 500               | 100                                    |

In all cases, where practicable, it is allowed to effect the operational earthing of each transmitter separately by connecting the earthing terminals of a transmitter to the nearest metal bulkhead by means of a copper busbar or a flexible conductor of adequate sectional area.

**4.7.2** In transmitters with emissive power above 50 W, the electric connection of the earthing busbar (flexible conductor) to the transmitter case shall be made in at least two places most widely apart.

**4.7.3** Operational earthings of radio receivers installed in the radioroom shall be effected by means of a copper busbar or a flexible bronze (copper) stranded wire with a sectional area of not less than 6 mm<sup>2</sup> run as directly as possible from each receiver to the main earthing busbar of transmitters or directly to the nearest metal bulkhead reliably connected to the ship's hull.

**4.7.4** Operational earthings of radio communication facilities, public address system and other radio apparatus shall be carried out in compliance with the requirements of the present Part of the Rules for operating earthings of receivers or transmitters.

**4.7.5** In non-metal ships the operational earthing shall be common for the shipborne radio equipment. In this case, the electrical contact of the earthing with water shall be effected by means of a tinned copper or brass plate of at least 4 mm thick and having an area of not less than 0,5 m<sup>2</sup> secured to the outside surface of the hull below the lightest draught of the ship. It is recommended to provide two such earthings; in such a case, the contacting surface of each earthing plate may be reduced to half the above value.

Metal keel binding or anti-teredo metal plating of wooden ships may be used instead of specially provided earthing gear.

**4.7.6** On non-metal lifeboats the earthing of the radio station shall be made with two tinned copper tapes



of not less than 1 mm thick and having the common area of not less than 0,1 m<sup>2</sup>, fitted to the right and to the left of the keel near the middle frame of the boat.

**4.7.7** The connecting wires of protective earthing of the apparatus cases shall be as short as possible, but not more than 150 mm long.

**4.7.8** Protective earthing of lower ends of standing rigging of masts and funnels shall be made with flexible metal conductors. Such conductors shall

be provided with special soldered thimbles which shall be secured to the metal hull of the ship by means of two screws or by welding. The spots of connection with the hull shall be painted.

**4.7.9** The total resistance of all electric connections of any earthing shall not exceed 0,02 Ohm.

**4.7.10** It is not allowed to use the earthing gear of radio equipment as a lightning arrester.

## 5 TECHNICAL AND OPERATIONAL REQUIREMENTS FOR RADIO EQUIPMENT

### 5.1 GENERAL

**5.1.1** Radio equipment shall be so designed and arranged that easy operation in compliance with the technical documentation requirements for it, access for survey, maintenance and repair is provided.

Each type of radio equipment shall be designed for being operated by one person.

**5.1.2** Radio equipment shall be so designed that replacement of its main units can be easily made without special tuning.

**5.1.3** In case any equipment unit is connected to one or several units of other equipment, the technical and operation requirements for all equipment shall be maintained.

**5.1.4** Easy, quick and efficient operation shall be provided by the amount of controls, their design, functioning, arrangement, construction and dimensions.

**5.1.5** The controls shall be so located as to eliminate the possibility of accidental use.

**5.1.6** The controls not used in the normal operation mode shall not be easily accessible.

**5.1.7** The controls, inadvertent operation of which may cause switching off or damage to the equipment as well as nonadequate signalling, shall be specially protected against unauthorized access.

**5.1.8** The construction of all controls shall prevent spontaneous changing of their preset positions.

**5.1.9** Controls of radio apparatus shall be protected against mechanical damage likely to occur when the face panel is put on the plane surface.

**5.1.10** The diagram and construction of equipment shall exclude any possibility of damage or any harm to service personnel as a result of wrong sequence in operating the controls.

**5.1.11** The controls and measuring instruments of radio apparatus shall be provided with distinct nameplates or conventional symbols designating their purpose and operation.

**5.1.12** In all cases, the position of the controls indicating "on", "start", "increase", etc., shall correspond to the setting of control handles upwards and from or to the right of the operator, turning the control knobs clockwise and pressing the upper or right-hand buttons. The position indicating "off", "stop", "decrease", etc. shall correspond to the setting of control handles down, towards or to the left of the operator, turning the control knobs counter-clockwise and pressing the lower or left-hand buttons.

The "on" position shall have light indication.

**5.1.13** Provision shall be made for adjustable lighting of the equipment itself or a ship allowing for the distinct discerning the controls and facilitating the display unit reading at any time.

**5.1.14** Calibration of principal dials, inscriptions, marks and positions of indicators and controls fitted on the apparatus shall be distinctly visible at a distance of 700 nun under standard illumination intensity and normal eyesight.

**5.1.15** The dials of basic instruments intended for measuring the current intensity in the aerial and in output stage of the transmitter as well as for measuring the ship's mains voltage shall be so calibrated as to make any correction factor unnecessary.

**5.1.16** Radio apparatus in which a cathode-ray indicator is used shall be capable of providing possibility for image viewing in daylight.

**5.1.17** It is recommended that special turn locks, wing nuts or latches, capable of being loosened without any tools applied, be used instead of threaded fastenings for the purpose of securing drop and sliding frames, removable panels to the cases of radio apparatus.

**5.1.18** Non-secured drop and sliding frames of radio apparatus shall be fitted with safety locks capable of operating in both directions to prevent possible falling of frames out of the cases.

Opening doors shall be fixed in the open position.

**5.1.19** Securing gear of removable and drop-type panels of radio apparatus shall be of non-falling-out construction.

**5.1.20** Access to all current-carrying parts of radio apparatus, except aerial leads-in and earthing wires shall be permitted only after opening the case. Where the opening of the case is carried out without applying any tools, then, after each opening, no unprotected conductor of radio apparatus shall remain under the voltage over 50 V relative to any other conductors or earth. The capacitors mounted in the circuits of more than 50 V shall be automatically discharge to the voltage of 50 V and less.

**5.1.21** The circuit and construction of radio apparatus shall not exclude the possibility of carrying out the tests of it while in operation, with the case remaining open using special tools. Adequate protection of the operating personnel against electric shock in circuits of more than 50 V shall be provided. The construction of radio apparatus shall provide possibility for opening the cases only after disconnecting the voltage over 50 V.

**5.1.22** All radio apparatus cases shall be fitted with terminals for connecting the earthing wire. The number and arrangement of earthing terminals on the cases of radio apparatus shall ensure removal of high-frequency voltage from the cases.

Opening doors, plug-in units and folding-back panels containing measuring instruments and other components of radio equipment shall be properly grounded by at least one flexible jumper.

**5.1.23** All metal parts mounted on the outside of the radio apparatus case shall be reliably electrically connected to the case.

**5.1.24** The connection of all cables to the radio apparatus shall be carried out, with continuity of screening being preserved. The screening metal sheathings of cables shall be electrically connected to the apparatus cases. Provision shall be made for mechanical securing of cable to the apparatus case.

**5.1.25** It is recommended to provide the radio apparatus and remote controls with devices capable of signalling any failure or critical operating conditions in essential circuits of radio equipment as well as switching on the power supply and voltage over 50 V. The colours adopted for light signalling system shall comply with the requirements specified in Part XI "Electrical Equipment" of Rules for the Classification and Construction of Sea-Going Ships.

**5.1.26** All interior wiring electric connections of radio apparatus shall be of screw, socket outlet or non-acid hot soldering kind, or of any other kind approved by the Register.

**5.1.27** All screw-type connections of the interior wiring as well as of the structural parts of radio apparatus the loosening of which is likely to disturb the apparatus parameters shall be strong and provided with special locking devices to prevent their getting loose. These locking devices shall be capable

of withstanding multiple loosening of nuts and screws without any damage being sustained by screw threads or the devices themselves.

**5.1.28** Interior components of radio apparatus shall have distinct and indelible markings corresponding to those of schematic and wiring diagrams. It is allowed to label the markings of small components on the frames (chassis) and screens of corresponding units as well as on enlarged photos attached to the description. Output terminals of radio apparatus shall be clearly labelled to indicate their purpose; power supply circuits shall have voltage and polarity markings.

**5.1.29** Inscriptions characterizing technical parameters and other data fixed on the radio apparatus shall be located at prominent places.

**5.1.30** The construction of plug-and-socket connections used in radio apparatus shall exclude any possibility of their wrong connection. Measures shall be taken to prevent wrong insertion of plugs into sockets not intended for their connection. Projecting contacts of plug-and-socket connections shall be not live when being in "off" position.

**5.1.31** If a forced cooling system is used in the radio equipment, it shall be provided with the dust filters being readily changeable.

**5.1.32** Facilities shall be provided to protect all operational software incorporated in the radio equipment. Any software required in equipment to facilitate operation in accordance with technical documentation, including that for its initial activation/reactivation, shall be permanently installed within the equipment, in such a way that it is not possible for the radiotelephone station personnel to have access to this software.

It shall not be possible for the operator to amend, augment or erase any software in the equipment required for operation in accordance with technical documentation.

Means shall be provided to monitor the operational software of the equipment automatically at appropriate regular intervals, as indicated in the equipment technical documentation, and to activate an alarm in the event of non-automatically recoverable failure.

**5.1.33** If the digital keyboard for digital input is provided, the digits shall be arranged in compliance with the recommendations of the International Radio Consultative Committee.

Where a letter-digital keyboard is provided for, the figures from "0" to "9" may alternatively be ranged in compliance with the ISO regulations.

**5.1.34** The display devices used within the radio equipment, with the screen diagonal not more than 0,5 m (with the exception of devices displaying not more than four information lines) shall not produce

magnetic induction exceeding 200 nT within frequency band of 5 Hz to 2 kHz and exceeding 25 nT within frequency band of 2 to 400 kHz at a distance of 50 cm from the device. In this case the magnetic induction level at a distance of 30 cm from the face of the display screen shall not exceed 200 nT within frequency band of 5 Hz to 2 kHz. The strength of the magnetic field induced by the display device at a distance of 50 cm in all directions from the device shall not exceed 10 V/m within frequency band of 5 Hz to 2 kHz and 1 V/m within frequency band of 2 to 400 kHz. Along with that, at a distance of 30 cm from the face of the display screen the strength of the induced electromagnetic field shall not exceed 1 V/m within frequency band of 2 to 400 kHz. The electrostatic field strength at a distance of 10 cm from the face of the display screen shall not exceed 5,0 ± 0,5 kV/m.

For the display devices with screen diagonal more than 0,5 m, higher field levels are accepted. In this case, the technical documentation for such devices shall state the minimum distances at which:

magnetic induction does not exceed 250 nT within frequency band of 5 Hz to 2 kHz and does not exceed 150 nT within frequency band of 2 to 400 kHz;

electromagnetic field strength does not exceed 15 V/m within frequency band of 5 Hz to 2 kHz and does not exceed 10 V/m within frequency band of 2 to 400 kHz;

electrostatic field strength does not exceed 5,0 ± 0,5 kV/m.

**5.1.35** Radio equipment shall generally be designed for power supply from the ship's mains having a voltage not exceeding 250 V. If voltage over 250 V is applied, the construction of the power switchboard as well as that of basic apparatus shall comply with the requirements of 5.1.25.

Design of the radio equipment shall ensure keeping of technical parameters at continuous variation of alternating current mains voltage by ± 10 per cent and frequency by ± 5 per cent as well as when power supply varies by + 30 per cent or - 10 per cent from the rated value if fed by accumulator battery or direct current mains.

Radio equipment shall remain operable at short voltage deviations in mains by ± 20 per cent within 1,5 s and frequency by ± 10 per cent within 5 s. Meanwhile, alarm shall not activate.

**5.1.36** Provision shall be made for protection of radio equipment against current inrushes and over-voltage as well as accidental change in polarity of the source of power and wrong sequence of phases within 5 minutes.

**5.1.37** Earthing (connection to the hull) of the ship's mains and accumulator batteries in circuits of radio equipment is not allowed.

**5.1.38** The voltage value between the contacts of microphones and headphones (between wires) as well as between them and the earth shall not exceed 50 V.

**5.1.39** Insulation resistance of feeding circuits of radio equipment measured between conductors and the case of the apparatus as well as between the windings of transformers shall not be below the rates given:

| Test conditions   | Insulation resistance, megohms |
|---|--------------------------------|
| Normal climatic conditions . . . . .                                  | 20                             |
| Temperature (50 ± 2)°C. Relative humidity below 20 per cent . . . . . | 5                              |
| Temperature (40 ± 2)°C. Relative humidity (95 ± 3) percent . . . . .  | 1                              |

**5.1.40** All feeding circuits of radio apparatus shall be fitted with readily replaceable fuses or circuit breakers. The construction of fuse cartridges shall exclude any possibility of accidental touching of current-carrying parts by the operating personnel while replacing fuses. The time necessary for access to fuses shall not exceed 5 s.

**5.1.41** All radio equipment shall be designed for shipboard operation under any service conditions and shall be capable of withstanding mechanical and climatic tests to at least standards given below:

**.1** at rolling, pitching and prolonged inclinations up to 45° with a rolling and pitching period of 7 to 9 s in two interperpendicular operational positions during 5 min;

**.2** under vibration conditions in the frequency range of 2 to 100 Hz with an amplitude of ± 1 mm for frequencies from 2 to 13,2 Hz and an acceleration of 0,7g (7 m/s<sup>2</sup>) for frequencies from 13,2 to 100 Hz in three interperpendicular positions;

**.3** under shock loads with an acceleration of 10g (100 m/s<sup>2</sup>), a pulse duration of 10 to 15 ms and a frequency of 40 to 80 bumps/min in three interperpendicular positions with the total number of bumps not less than 1000.

Subject to the type of equipment, place of installation and sea area of navigation, the shock tests may be liable to the special consideration by the Register;

**.4** at a temperature of 55 ± 3 °C for the equipment designed to operate in the interior spaces and on the open decks of the ship during 10 to 16 h in the operating condition, and at a temperature 70 ± 3 °C in the idle condition during 10 to 16 h.

**.5** at a relatively humidity of air 95 ± 3 per cent and a temperature of 40 ± 2 °C during 10 days to 16 hours.

**.6** at a temperature of - 15 ± 3 °C and - 40 ± 3 °C (for the fixed equipment designed to operate in the interior spaces of the ship and on the open decks of the

ship respectively) during 10 to 16 h in the operating conditions and at a temperature of  $-60 \pm 3$  °C in the idle condition during 2 h.

Radio equipment shall be capable of resisting the brine (sea) fog.

Radio equipment shall be mould growth resistant and capable of withstanding the effect of hoarfrost, dew and icing (for the equipment designed to operate on the open decks of the ship).

Portable radio equipment shall be capable of resisting the solar radiation.

Portable radio equipment shall be capable of resisting oil.

Materials used for the manufacture of shipborne radio equipment shall ensure its long-term operation under the above conditions.

The mast-type aerials and other aerials of self-supporting type shall satisfy the tests within the limits of possible use of the test benches and chambers.

**5.1.42** The degree of protection of the radio equipment arranged in ship spaces shall be not lower than that indicated in Table 5.1.42.

**5.1.43** Radio apparatus shall comply with the following requirements which ensure the electromagnetic compatibility (EMC) on board ship.

**5.1.43.1** The voltage level of conducted interference from radio equipment at the electric power supply terminals shall not exceed values shown in Fig. 5.1.43.1.

**5.1.43.2** The intensity level of radiated interference field produced by radio equipment at a distance of 3 m from the casing shall not exceed values shown in Fig. 5.1.43.2.

**5.1.43.3** Radio equipment (except for the portable equipment) shall be immune to conducted low-frequency interference when the following additional test voltages are imposed on supply voltage within the frequency range from 50 Hz to 10 kHz:

**.1** for equipment with D.C. power supply — sine voltage the actual value of which is 10 per cent of the rated supply voltage;

**.2** for equipment with A.C. power supply — sine voltage the actual value of which, in relation to the rated supply voltage, varies with the frequency as shown in Fig. 5.1.43.3.

Table 5.1.42

| Nos | Type of radio apparatus  | Installation site            | Degree of protection |
|-----|--|------------------------------|----------------------|
| 1   | Leads-in of aerials  | Anywhere in ship             | IP00                 |
| 2   | Communicating devices of aerials and apparatus containing no high-frequency circuits | Enclosed spaces              | IP20                 |
| 3   | Radio apparatus, except apparatus specified in items 1 and 2                         | Enclosed spaces              | IP21                 |
| 4   | Radio apparatus, except apparatus specified in item 1                                | Navigating bridge, radioroom | IP22                 |
| 5   | Two-way VHP radiotelephone apparatus and radar transponders                          | Open decks                   | IP56                 |
| 6   | Emergency radio beacon (in operational condition)                                    | Survival craft<br>Open decks | IP68<br>IP68         |

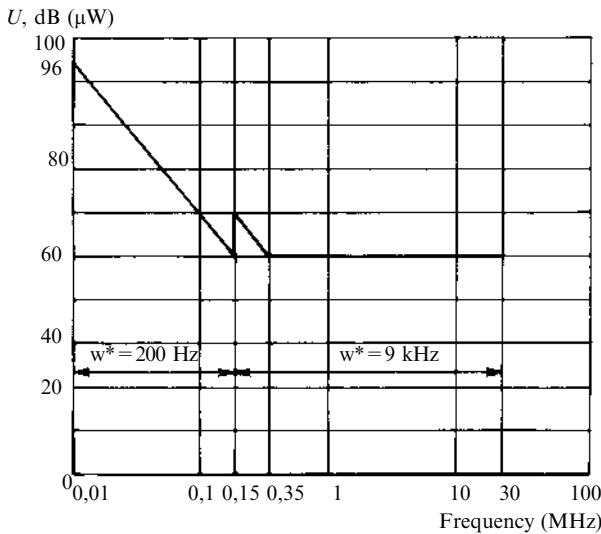

Fig. 5.1.43.1

Curve of the permissible level of conducted interference voltage  $U$ , measured at the electric power supply terminals:  
 $W^*$  is the meter bandwidth

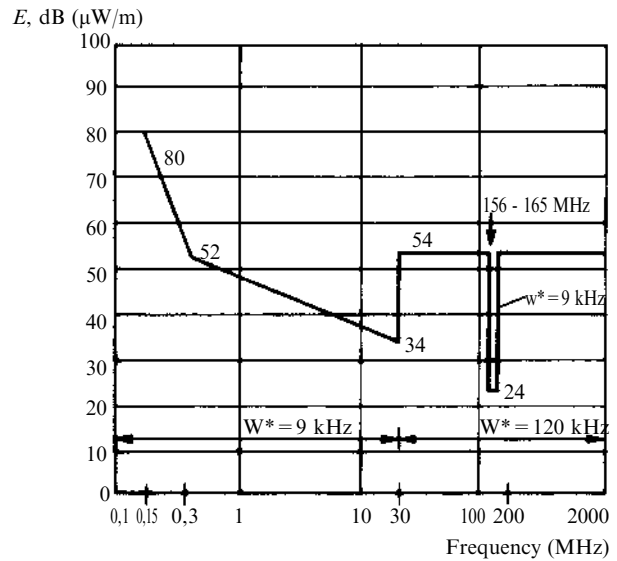

Fig. 5.1.43.2

Curve of the permissible intensity level of radiated interference field measured at a distance of 3 m from the equipment casing:  
 $W^*$  is the meter bandwidth

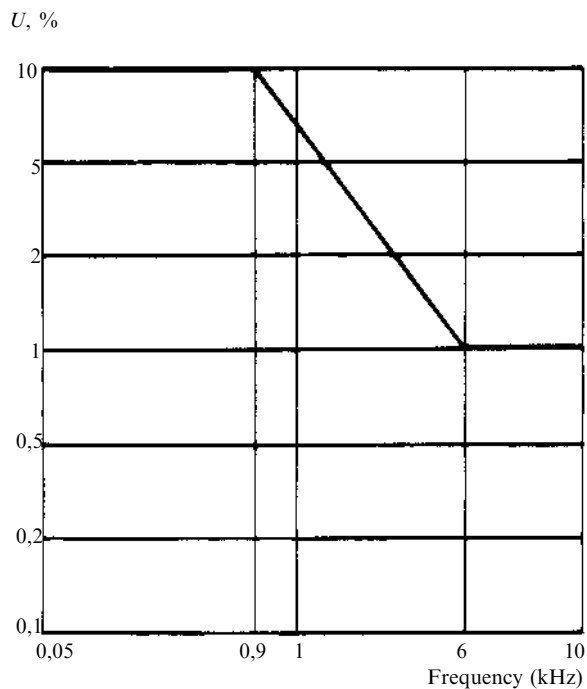

Fig. 5.1.43.3

Curve of the test voltage used to check the equipment for immunity to low-frequency conducted interference

**5.1.43.4** Radio equipment, except for the portable equipment shall be immune to conducted radio frequency interference when the following sine voltage are applied to input terminals of the power supply sources, signalling and control circuit of equipment:

**.1** with an actual voltage value of 3 V at the frequency which varies from 10 kHz to 80 MHz;

**.2** with actual voltage value of 10 V at the points with frequencies: 2 MHz; 3 MHz; 4 MHz; 6,2 MHz; 8,2 MHz; 12,6 MHz; 16,5 MHz; 18,8 MHz; 22 MHz and 25 MHz.

Modulation frequency of the test signal shall be  $400 \text{ Hz} \pm 10$  per cent with modulation depth of  $80 \pm 10$  per cent.

**5.1.43.5** Radio equipment shall be immune to radiated radio frequency interference, where located within a modulated electric field with an intensity of 10 V/m when the test signal frequency varies from 80 MHz to 2 GHz. Modulation frequency of the test signal in this case shall be  $400 \text{ Hz} \pm 10$  per cent with modulation depth of  $80 \pm 10$  per cent.

**5.1.43.6** Radio equipment, except for the portable equipment, shall be immune to nanosecond pulse interference induced by fast transients when the following test pulse voltages are applied to input terminals of the power supply sources, signalling and control circuits of the equipment:

**.1** with an amplitude of 2 kV and repetition frequency of 2,5 kHz — at the differential inputs of A.C. power supply sources;

**.2** with an amplitude of 1kV in relation to the common earthed input and with a repetition frequency of 5 kHz — at the inputs of signalling and control circuits.

The test signal rise time in this case shall be 5 ns (at 10 to 90 per cent amplitude level), pulse duration shall be 50 ns (at 50 per cent amplitude level).

**5.1.43.7** Radio equipment, except for the portable equipment, shall be immune to microsecond pulse interference induced by slow transients when a test pulse voltage with amplitudes: 2 kV — line/earth, 1 kV — line/line is applied to its A.C. power supply circuits.

The test signal rise time in this case shall be  $1,2 \mu\text{s}$  (at 10 to 90 per cent amplitude level), duration —  $50 \mu\text{s}$  (at 50 per cent amplitude level), repetition frequency — 1 pulse/min.

**5.1.43.8** Radio equipment, except for the portable equipment, shall remain operative at power supply voltage during 60 s. In this case, the possibility of failure of the software and loss of the on-line data shall be ruled out.

**5.1.43.9** Radio equipment shall be immune to electrostatic discharges at the voltage levels of test discharge: 6 kV — for contact discharge, 8 kV — for air discharge.

**5.1.44** The ambient noise level produced by radio equipment during its operation (with the sound alarm switched off) shall not exceed 60 dB at a distance of 1 m from any part of the equipment.

The acoustic noise level produced by the sound alarm at a distance of 1 m from the noise source, except for the sound alarm for reception of distress alert, shall be within the range from 75 to 85 dB.

The sound alarm for reception of distress alert shall be audible in any location of the navigating bridge at any noise level possible in operation of the ship, and along with that, the acoustic noise level produced by this alarm at a distance of 1 m from the noise source shall be not lower than 75 dB.

**5.1.45** The X-radiation level induced by individual units of the radio equipment (cathode-ray indicators, transceiver components, etc.) shall not exceed 5 mJ/kg (0,5 mrem/hour) at a distance of 5 cm from the surface of the devices.

**5.1.46** The radio equipment to be installed near the magnetic compass shall be provided with clear inscriptions indicating the minimum safe distance, at which it can be located away from the compass. The minimum safe distance to the magnetic compass shall be deduced by recognising that at this distance the influence of the specific radio equipment (or individual unit) in “on” position is such that the deviation

of the magnetic compass does not exceed  $5,4^\circ/V$  for magnetic compasses installed on the upper bridge and not less than  $18^\circ/V$  for magnetic compasses installed inside the navigating bridge (where  $V$  (T) is the horizontal component of the Earth magnetic field induction).

**5.1.47** Radio equipment shall have distinct markings containing the following information, at prominent places:

- .1 manufacturer data;
- .2 radio equipment type number or the name under which the radio equipment has passed type tests;
- .3 radio equipment serial number, assigned by manufacturer;
- .4 year of manufacture;
- .5 type of current and supply voltage;
- .6 safe distance between radio equipment and magnetic compass.

**5.1.48** Spare parts for radio equipment shall be kept under the conditions preventing any probability of their damage and ensuring the possibility of their convenient transfer as well as for their ready identification in respect to the type of equipment they are designed to serve.

## 5.2 GENERAL REQUIREMENTS FOR EQUIPMENT OF RADIO COMMUNICATION FACILITIES

**5.2.1** The equipment of radio communication facilities shall be capable of transmitting and receiving radio alerts for distress, urgency and safety in the shortest possible time. To fulfil the above purpose the equipment shall comply with the following requirements.

**5.2.1.1** Switching on the power supply of the equipment providing distress alert as well as communication in distress and for safety, shall be performed by one step manipulation only.

**5.2.1.2** Starting period of transmitters and receivers shall not exceed 1 min.

**5.2.1.3** Frequency retiming period of radio apparatus shall be as short as possible, but it shall not exceed 15s. Emissions shall not be produced during the frequency retuning period.

**5.2.1.4** Switching over from transmission to reception and vice versa, while using shipboard radio communication facilities, shall be effected automatically. The level of radio interference produced by the transmitter shall not exceed the permissible rates accepted in the national standards.

**5.2.1.5** Switching over from one class of emissions to another shall be performed by one step manipulation only.

**5.2.1.6** Radio installations shall include means of automatic data input for correction of the ship's

coordinates, the date and the time of their determination from electronic navigational aids for detection of locations which may be a constituent part of radio installations.

Radio installations, where electronic navigational aids for detection of locations are not installed, shall include the special device (interface) intended for digital interface with electronic navigational aids for detection of locations for compliance with the above requirement.

Besides, radio installations shall include means for manual input of the ship's coordinates, the date and the time of their determination.

Audible and visible signalling operating in cases when the data from the electronic navigational aids for detection of locations have not been received or in cases of manual input when these data have not been updated during 4 h shall be provided. Any information on the ship's coordinates not being updated during more than 23,5 h shall be automatically deleted.

For INMARSAT ship earth station, information on the ship coordinates not being updated during more than 24 h shall be clearly indicated.

**5.2.1.7** Any distress alert initiation shall be carried out by two independent actions only by means of a dedicated button. This button shall be clearly identified (of red colour) and protected against inadvertent operation.

The distress alert initiation button shall be enclosed by a spring loaded lid or cover permanently attached to the equipment (e.g. by hinges).

It is not necessary for the user to remove seals or to break the lid or cover for the distress alert initiation.

The operation of the distress alert initiation button shall be accompanied by audible and visible indication.

The distress alert initiation button shall be pressed during at least 3 s. The flashing light and an intermittent signal shall start immediately. In 3 s the distress alert shall be initiated and the indication (audible and visible) shall become steady.

The equipment shall indicate the status of the distress alert transmission. It shall be possible to interrupt and initiate distress alerts at any time (see 1.2).

**5.2.2** Radio equipment for transmission of the distress alert shall be designed in a way preventing its inadvertent operation.

The panel for radio equipment emergency operation shall be isolated from the panel for regular operation and closed with a cover. Switches on the emergency panel shall be clearly coloured.

**5.2.3** The construction of the apparatus intended for transmitting distress alerts as well as communication in distress and for safety shall provide for rapid detection and elimination of any faults. To fulfil this

Table 5.2.4

| Nos | Frequency range (including upper and excluding lower limit)       | Radio communication facilities   | Permissible frequency tolerance | Permissible relative frequency tolerance                         |
|-----|---|--|---------------------------------|--|
| 1   | (1605 – 4000) kHz   | MF radio installation  | 40 Hz <sup>1, 2, 3</sup>        | —  |
| 2   | (4000 – 29700) kHz<br>For emission class A1A<br>For other classes | HF radio installation  | —                               | $10 \times 10^{-6}$ <sup>4</sup>                                 |
| 3   | (156 – 174) MHz   | VHF radio installation   | 50 Hz <sup>1, 2</sup>           | $10 \times 10^{-6}$  |
| 4   | Beyond range (156 – 174) MHz                                      | Two-way VHF radiotelephone apparatus<br>Two-way VHF radiotelephone apparatus for communication with aircrafts<br>VHF radiotelephone station<br>Radiotelephone station for internal service communication | —                               | $50 \times 10^{-6}$<br>$50 \times 10^{-6}$<br>$5 \times 10^{-6}$ |
| 5   | 470 – 2450 MHz  | Ship earth station   | —                               | $20 \times 10^{-6}$  |

<sup>1</sup>For narrow band phase-shift keying – 5 Hz; For transmitters with frequency-shift keying – 10 Hz.  
<sup>2</sup>Permissible deviation for transmitters of ship earth radio installations shall be 10 Hz.  
<sup>3</sup>For emission class A1A permissible relative deviation of frequency shall be  $50 \times 10^{-6}$ .  
<sup>4</sup>For transmitters of ship earth stations installed on small boat operated in coastal area and working in a frequency range of (26175 to 27500) kHz, power of carrier frequency up to 5 W and using emission class A3E or F3E and G3E, permissible relative deviation of frequency shall be  $40 \times 10^{-6}$ .

purpose the opening of cases for providing access to interior parts of apparatus shall be effected in the shortest possible time and without applying any tools, considering 5.1.20.

**5.2.4** Frequency tolerance of transmitters and receivers shall not exceed the values given in Table 5.2.4.

**5.2.5** All shipboard VHF, MF/HF transmitters shall be designed for continuous operation during at least 6 h, the ratio of the total emission duration to the pause duration being 2:1.

The two-way VHF radiotelephone apparatus intended for survival craft and two-way VHF radiotelephone apparatus intended for communication with aircrafts shall be capable of continuous operation during 8 h, when operating cycle being 1:9 (see Table 2.3.4, footnote 7).

**5.2.6** The mean power of any spurious emission supplied to the aerial feeder of a transmitter operating within the frequency range below 30000 kHz shall be at least 40 dB less than the mean power on the base emission frequency and in no case shall exceed 50 mW.

For frequency-modulated maritime mobile radiotelephone equipment which operates above 30000 kHz, the mean power of any spurious emission falling in any other international maritime mobile service channel, due to products of modulation, shall not exceed a level of 10  $\mu$ W and the mean power of any other spurious emission on any discrete frequency within the international maritime mobile service band shall not exceed a level of 2,5  $\mu$ W.

Where, exceptionally, transmitters of mean power above 20 W are employed, these levels may be increased in proportion to the mean power of the transmitter.

Average power of any side emission of all ship transmitters in a standby mode shall not exceed 2 nW.

**5.2.7** The upper sideband shall be used for classes of emission H3E and J3E.

**5.2.8** For class of emission J3E the degree of carrier suppression shall be at least 40 dB.

For class of emission H3E the degree of carrier suppression shall be  $5 \pm 1$  dB.

**5.2.9** Unwanted frequency modulation of the carrier frequency shall be sufficiently low to prevent harmful distortion.

**5.2.10** When using classes of emission H3E and J3E the power of unwanted emissions supplied to a transmitting aerial on any discrete frequency shall, when the transmitter is driven to full peak power, be in accordance with Table 5.2.10. The difference

Table 5.2.10

| Separation $\Delta$ , kHz, between the frequency of the unwanted emissions and the assigned frequency <sup>1</sup> | Minimum attenuation below peak power, dB |
|--|--|
| $1,5 < \Delta \leq 4,5$  | 31                                       |
| $4,5 < \Delta \leq 7,5$  | 38                                       |
| $7,5 < \Delta \leq$  | 43, without exceeding the power of 50 mW |

<sup>1</sup>Assigned frequency of a single-band channel shall be 1400 Hz higher than the carrier frequency.

between emitted power in pause (B) and sending (Y) shall not exceed 2 dB.

**5.2.11** The audio-frequency bandwidth of transmitters operating on classes of emission H3E and J3E shall be from 350 to 2700 Hz with permissible amplitude tolerance not exceeding 6 dB.

**5.2.12** The depth of modulation of transmitters operating on classes of emission H3E shall not be less

than 80 per cent. The depth of modulation caused by extraneous voltage sources shall not exceed 5 per cent.

Modulation of transmitters operating on emissions of class J3E shall be such that the components of mutual modulation are lower than relative highest level of one of two tones by 25dB.

**5.2.13** All transmitters with rated power above 20 W shall be provided with measuring instrument capable of continuously monitoring, under operating conditions, the availability of aerial current. Failure of such measuring instrument shall not cause the disconnection of the aerial circuit. Every transmitter shall be provided with a reserve tuning indicator. Transmitters with the rated power of 20 W and less shall be provided with at least one tuning indicator.

**5.2.14** If the transmitter is provided with the automatic frequency tuning device, it shall ensure:

**.1** automatic tuning of the transmitter output with the parameters of the aerial connected;

**.2** visual indication of readiness of the transmitter for operation, any fault in the automatic tuning device or the aerial parameters deviating from the predetermined values;

**.3** tuning during 5 s.

In case of short-circuiting or a break of the aerial a tuning device shall not fail or cause the transmitter damage.

**5.2.15** A break of the aerial or its earthing to the ship's hull shall not cause any damage of the equipment.

**5.2.16** The controls mounted directly on the transmitter case shall include the controls which provide possibility for emission of single-band mono-signal with frequency within 450 to 1000 Hz while operating on class J3E.

**5.2.17** Intermediate frequency shall not cause interference in guard bands of international distress and safety frequencies.

**5.2.18** Unless expressly provided otherwise, the bandwidth of a low frequency channel of a receiver shall be not less than 350 to 2700 Hz provided the tolerance of the receiver output level relating to frequency 1000 Hz is  $\pm 6$  dB.

**5.2.19** All feeding circuits of receivers shall be fitted with devices for protection against radio interference produced by the ship's electronic equipment.

**5.2.20** Input circuits of receivers shall be protected against voltage induced by operating ship-board transmitters at 30 V e.m.f. within 15 min.

**5.2.21** Back radiation intensity value of receivers shall not exceed the permissible rates accepted in the national standards.

**5.2.22** The tuning indicators of receivers shall comply with the following requirements:

**.1** indicators shall be provided with distinct contrast calibration visible under any lighting conditions of spaces;

**.2** indicators shall be calibrated in kHz or MHz depending on the portion of the frequency range;

**.3** international distress, safety and call frequencies in the radiotelephony mode shall be specially marked;

**.4** indicators shall be protected against mechanical damage.

**5.2.23** Receivers shall be provided with measuring instruments capable of checking their operating performances.

**5.2.24** The construction of shipboard receivers shall provide possibility for connecting a coaxial screened cable to the aerial terminal, with continuity of screening being preserved.

**5.2.25** Receivers shall be capable of receiving radio signals during the pause in manipulation of their own transmitter. The time necessary for restoring full sensitivity of a receiver after manipulation shall not exceed 0,1 s, with automated gain control being disconnected.

**5.2.26** Loudspeakers mounted in the receivers shall be provided with switches.

**5.2.27** All shipboard receivers shall be capable of 24-hour continuous operation.

**5.2.28** If radio equipment intended for distress alert as well as for communication in distress and for safety has additional functions, this shall not affect the main functions of the equipment.

**5.2.29** The basic requirements for ship's complex radio stations and remote control desks of ship radio communication facilities are those listed below.

**5.2.29.1** When developing ship's complex radio stations incorporating radio communication facilities housed in one sectionalized cabinet combined with the operator's table and combined remote control desks of ship radio communication facilities, the relevant requirements of 5.1 and 5.2 as well as requirements given below, shall be met.

**5.2.29.2** Controls and indicators of the complex radio station shall generally be concentrated on the front side of the common control panel to be preferably positioned at a height of 800 to 1200 mm above the deck, provided the top surface of the operator's table is at a height of 750 mm above the deck. Control panels of ship transmitters shall be incorporated in the common control panel as its sections.

**5.2.29.3** In complex radio stations with a vertically arranged common control panel of a board type, a part of the table top surface against the operator's position shall remain free within the semicircle the radius of which is 520 mm.

In complex radio stations with an inclined common control panel of a desk type, a part of the table top surface against the operator's position shall remain free within the semicircle the radius of which



is 450 mm. The angle of inclination of the common control panel from the vertical shall not exceed 30.

**5.2.29.4** Clearly marked boundaries of sections intended for controls of each type of equipment shall be provided on the common control panel of the complex radio station. Controls of each equipment type shall be arranged in the sequence of their use from left to right or from up to down.

**5.2.29.5** Access to the interior parts of the equipment incorporated in each section shall be possible without use of any tools.

**5.2.29.6** Controls shall be arranged within the section of each type of equipment by separate groups at a certain distance from one another. Each group shall incorporate only such controls, which are functionally consistent with, or dependent on, one another.

In so doing, if any control is not consistent with other controls or does not functionally depend on them, it shall be considered as separate group.

All control grips shall be of the same type, size and shape within each group. However, in no group use is permitted of the grip types utilized in any other group.

**5.2.29.7** There shall be no need to operate controls of the equipment using two hands simultaneously. Exception may be made only for controls intended for opening and closing housings of the equipment.

**5.2.29.8** Buttons of the complex radio station relating to one group shall differ in colour from those belonging to any other group.

**5.2.29.9** All controls of the complex radio station shall be provided with clear inscriptions indicating their purpose. Provision shall be made for each button for inscriptions, symbols or digits specifying their application.

**5.2.30** The remote control desk of radio communication facilities shall comply with the following requirements:

**.1** all controls shall be provided allowing for the radio communication without using the controls fitted directly on a receiver, transmitter or radio station;

**.2** signalling system shall be provided to control the operation and give warning of faults of the apparatus;

**.3** it shall not cause the apparatus parameters lying outside the limits specified by the present Part of the Rules and produce interference.

**5.2.31** Radio equipment in addition to the requirements specified in the present Part of the Rules shall comply with the relevant requirements of ITU.

**5.2.32** In case of using the computer systems in the radio installations they shall comply with the requirements of Part XV "Automation" of Rules for the Classification and Construction of Sea-Going Ships.

## 6 RADIO COMMUNICATION FACILITIES

### 6.1 VHF RADIO INSTALLATION

**6.1.1** The radio installation shall provide for the following categories of calls using radiotelephony and digital selective calling for the purposes:

- .1** distress, urgency and safety;
- .2** ship operational requirements; and
- .3** public correspondence.

**6.1.2** The radio installation shall provide for the communications using radiotelephony for the purposes:

- .1** distress, urgency and safety;
- .2** ship operational requirements; and
- .3** public correspondence.

**6.1.3** The radio installation shall comprise:

- .1** a transmitter/receiver including antenna;
- .2** an integral control unit or one or more separate control unit (units);
- .3** a microphone with a press-to-transmit switch, which may be built in a handset;
- .4** an internal or external loudspeaker;
- .5** an integral or separate digital selective calling facility;

**.6** a dedicated DSC watchkeeping facility to maintain a continuous watch on channel 70.

The radio installation may also include additional receivers.

**6.1.4** DSC facility shall provide operation on channel 70 and shall comprise:

- .1** means to decode and encode DSC messages;
- .2** means necessary for composing the DSC messages;
- .3** means to verify the prepared message before it is transmitted;
- .4** means to display the information contained in a received call in plain language;
- .5** means for entry of ship's position information and the time at which the position was determined (see 5.2.1.6);

**.6** if the received messages are not printed immediately, sufficient capacity of memory shall be provided to enable at least 20 received distress messages to be stored in the DSC facility.

These messages shall be stored in memory until readout and shall be erased 48 h after they have been received;

**.7** initiation of DSC distress alerts shall supersede any other operation of the facility;

**.8** self-identification data shall be stored in the DSC unit. It shall not be possible for the user easily to change these data;

**.9** means shall be provided to enable routine testing of the DSC facilities without radiation of signals;

**.10** With a DSC modulated input signal having a level of 1  $\mu$ V e.m.f. to its associated VHF receiver, the DSC equipment shall be capable of decoding the received message with a maximum permissible output character error rate of  $10^{-2}$ .

**6.1.5** Radiotelephone station belonging to VHF radio installation shall comply with the following requirements.

**6.1.5.1** The radio station shall be designated for maintaining radio communication on frequencies of the Maritime Mobile Service in the band 156 to 174 MHz using following classes of emission:

**.1** G3E – on the radiotelephone channels;

**.2** G2B – DSC channel 70.

Frequency range between channels shall be 25 kHz.

**6.1.5.2** Radio station shall be capable of operating:

**.1** within the frequency range of 156,3 to 156,875 MHz on simplex channels;

**.2** within the frequency range of 156,025 to 157,425 MHz for transmission and within the frequency range of 160,625 to 162,025 MHz for reception on duplex channels.

**6.1.5.3** The radio station shall have sufficient number of channels, but not less than five, including channel 70 (156,525 MHz); channel 6 (156,3 MHz); channel 13 (156,65 MHz); channel 16 (156,8 MHz).

**6.1.5.4** The maximum deviation of frequency corresponding to 100 per cent depth of modulation shall be as close to  $\pm 5$  kHz as practicable. Frequency instability shall vary within the limits  $\pm 1,5$  kHz.

**6.1.5.5** Frequency modulation shall have a preemphasis of 6 dB per octave with subsequent deemphasis in the receiver.

**6.1.5.6** The audio frequency bandwidth shall not exceed 3000 Hz.

**6.1.5.7** The radio station shall be provided with a vertically polarized antenna. As far as practicable, an emission shall be omnidirectional in the horizontal plane.

**6.1.5.8** The rated power of a transmitter shall be not less than 6 W and not more than 25 W.

The transmitter shall be provided with a device capable of reducing power to 1 W or less except for 70 (156,525 MHz) channel.

**6.1.5.9** The sensitivity of the receiver shall be equal to or better than 2  $\mu$ V e.m.f for an output signal-to-noise ratio of 20 dB. Blocking shall be at least 90 dB $\mu$ V.

**6.1.5.10** The bandwidth of the receiver on high (intermediate) frequency at a level of 6 dB shall be sufficient for receiving a signal with the maximum frequency deviation of  $\pm 5$  kHz.

**6.1.5.11** Adjacent-channel selectivity of the receiver shall be not less than 75 dB.

**6.1.5.12** Intermodulation selectivity of the receiver shall be not less than 70 dB.

**6.1.5.13** Non-linear distortion factor of the receiver shall be not more than 7 per cent.

**6.1.5.14** Radio station receiver's output shall be designed for a loudspeaker power at least 2 W and a handset power 1 mW. Provision shall be made for connecting the loudspeaker without influence on the output sound power of handset.

**6.1.5.15** The receiver shall be provided with a manual volume control by which the audio output may be varied.

**6.1.5.16** The 16th channel shall be fitted with a device capable of providing the minimum power of the loudspeaker equal to 50 mW when the manual volume control is set in zero position.

**6.1.5.17** A squelch control shall be provided on the face panel of the radio station.

**6.1.5.18** An on/off switch shall be provided for the entire VHF installation with a visual indication that the installation is switched on.

**6.1.5.19** The radio station shall indicate the channel number to which it is tuned. It shall allow the determination of the channel number under all conditions of lighting. Where practicable, channels 16 and 70 shall be distinctively marked.

**6.1.5.20** A visual indication that the carrier frequency is being transmitted shall be provided.

**6.1.5.21** The radio station is recommended to include devices permitting radio communication to be maintained from the navigating bridge wings.

**6.1.5.22** The radio station shall not be able to transmit during channel switching operation.

**6.1.5.23** Operation of the transmit/receive control shall not cause unwanted emissions.

**6.1.5.24** Provision shall be made for changing from transmission to reception by use of a press-to-transmit switch. Additionally, facilities for operation on duplex channels without manual control may be provided.

**6.1.5.25** Change of channel shall be capable of being made within 5 s.

The time taken to switch from the transmit to the receive condition, and vice versa, shall not exceed 0,3 s.

**6.1.5.26** During duplex operation (emission) the loudspeaker shall be switched off automatically. Provision shall be made for prevention of electric and acoustic feedback in handset.

**6.1.5.27** Switching over from simplex to duplex operation and vice versa shall be effected automatically with the transition to the corresponding channels.

**6.1.5.28** In the transmit condition during simplex operation, the output of the receiver shall be muted.

**6.1.5.29** In the absence of the scanning condition a device shall be provided capable of switching over the radio station to the 16th channel when a handset is in its regular position.

**6.1.5.30** The radiotelephone station having multi-channel watch (scanning) facilities shall comply with the following requirements:

**.1** it shall be provided with the automatic scanning of a priority channel and an additional channel;

**.2** if selection of a priority channel is not provided, the priority channel shall be the 16th channel;

**.3** the channel numbers of both channels being scanned shall be clearly indicated simultaneously;

**.4** when the scanning facility is operating, transmission shall not be possible;

**.5** when the scanning facility is switched off, both transmitter and receiver shall be tuned automatically to the selected additional channel;

**.6** provision shall be made for a manual control in order to switch for operation on the priority channel by a single control unit;

**.7** scanning characteristics:

the priority channel shall be scanned with a sampling frequency of not less than once per two seconds;

if a signal is received on the priority channel, the receiver shall remain on this channel for a duration of that signal;

if a signal is received on the additional channel, the scanning of the priority channel shall continue, thus interrupting reception on the additional channel for periods as short as possible and not greater than 150 ms. Receiver shall be so constructed that its reliable operation was maintained during scanning the priority channel;

in the absence of a signal on the priority channel and during reception of a signal on the additional channel; the duration of each listening period on this channel shall be at least 850 ms;

means shall be provided to indicate the channel on which a signal is being received.

## 6.2 MF RADIO INSTALLATION

**6.2.1** The radio installation shall provide for the following categories of calling using both radiotelephony and digital selective calling (DSC) for the purposes:

- .1** distress, urgency and safety;
- .2** ship operational requirements;
- .3** public correspondence.

**6.2.2** The radio installation shall provide for the following categories of communication using radiotelephony for the purposes:

- .1** distress, urgency and safety;
- .2** ship operational requirements; and
- .3** public correspondence.

**6.2.3** If the radio installation is intended for distress alerts only or also for communication in distress and for safety, the requirements of 6.2.1.2, 6.2.1.3, 6.2.2.2 and 6.2.2.3 are not obligatory.

**6.2.4** The radio installation shall comprise:

**.1** a transmitter/receiver including antenna;

**.2** an integral control unit or separate control unit (units) with a telephone handset and an internal or external loudspeaker;

**.3** an integral or separate digital selective calling facility;

**.4** a dedicated DSC watchkeeping facility to maintain a continuous watch on the frequency 2187,5 kHz.

**6.2.5** The transmitter shall be capable of transmitting within the frequency range of 1605 to 4000 kHz. Number of fixed frequencies shall be not less than two: 2182 and 2187,5 kHz.

**6.2.6** The transmitter shall be capable of transmitting using classes of emission J3E and either J2B or F1B.

**6.2.7** Means shall be provided to prevent over-modulation automatically.

**6.2.8** During normal modulation, the peak envelope power in the class of J3E emission, or the mean output power of transmitter in the classes of J2B or F1B emissions, shall be at least 60 W and not more than 400 W at any frequency within operating range of frequencies.

**6.2.9** If the mean output power of transmitter exceeds 150 W, provision shall be made to reduce it to 60 W or less except frequencies 2182 kHz and 2187,5 kHz at which the value of the mean output power of transmitter shall be at least 60W.

**6.2.10** The transmitter shall be provided with a standard artificial aerial:  $C=250$  pF,  $R=10$  Ohm with series connection.

**6.2.11** The receiver shall be capable of being tuned throughout the bands between 1605 and 4000 kHz. Tuning shall be either continuous, or by incremental steps, or by their combination. It is allowed to use the receiver tuned to the fixed frequencies which shall be at least two: 2182 and 2187,5 kHz.

**6.2.12** The receiver shall be capable of receiving signals of the following classes of emission: J3E, H3E, J2B and F1B.

**6.2.13** The receiver frequency shall at all times remain within 10 Hz of the required frequency following the warming-up period.

**6.2.14** For classes of emission J3E and F1B the sensitivity of the receiver shall be equal to or better than  $6 \mu\text{V}$  e.m.f. at the receiver input for a signal-to-noise ratio of 20 dB. For DSC an output character error rate of  $10^{-2}$  or less shall be obtained for a signal-to-noise ratio of 12 dB.

**6.2.15** Adjacent-channel selectivity of the receiver shall exceed values given in Table 6.2.15.

Table 6.2.15

| Class of emission | Carrier frequency of unwanted signal distant from carrier frequency of valid signal by, kHz | Adjacent-channel selectivity  |
|-------------------|---|---|
| J3E               | -1 +4   | 40 dB   |
|                   | -2 +5   | 50 dB   |
|                   | -5 +8   | 60 dB   |
| H3E               | -10 +10   | 40 dB   |
|                   | -20 +20   | 50 dB   |
| F1B               | -0,5 +0,5   | 40 dB (analogue output);<br>character error ratio $\leq 10^{-2}$ (digital output) |
|                   | -0,5 +0,5   |   |

Selectivity on spurious channels shall be not less than 60 dB.

Inter-modulation selectivity shall be not less than  $70 \text{ dB}\mu\text{V}$  for the class of emission F1B and not less than  $80 \text{ dB}\mu\text{V}$  for the class of emission J3E.

Blocking shall be not less than 65 dB when interference tuning out is  $\pm 20$  kHz.

Non-linear distortion factor of the receiver shall not exceed 7 per cent.

**6.2.16** The receiver shall be provided with an automatic gain control of which effectiveness ensures alteration of the output voltage no more than by 10 dB if the input voltage varies by 70 dB.

**6.2.17** Radio station receiver's output shall be designed for a loudspeaker power at least 2 W and a handset power 1 mW. Disconnection of a loudspeaker shall not affect the output sound power of a handset.

**6.2.18** An unearthed output shall be provided for DSC signals if the corresponding facility is not integrated. Output signal shall be 0 dB at a load of 600 Ohm regulated to the precision of  $\pm 10$  dB.

**6.2.19** The DSC facility shall be capable of decoding and encoding DSC formats, their composing and verifying.

**6.2.20** Indication in clear for understanding form shall be provided for the DSC formats received and being entered.

The size of the means to display information shall be such as to contain at least 160 characters in two or more lines.

**6.2.21** Means shall be provided for entry of ship's position information, the date and the time at which the position was determined (see 5.2.1.6).

**6.2.22** If the received messages are not printed immediately, sufficient capacity of memory shall be provided to enable at least 20 received distress messages to be stored in the DSC facility. These messages shall be stored until readout.

These messages shall be erased 48 h after they have been received.

**6.2.23** Self-identification data shall be stored in the memory of the DSC unit. It shall not be possible for the user easily to change these data.

**6.2.24** Means shall be provided for periodic checking the DSC facility without signal emission.

**6.2.25** Control of the radio installation shall be possible from an integrated control unit or separate control unit (units).

If two separate control units are available, control unit at the position from which the ship is normally navigated shall have priority.

**6.2.26** A control system for the radio installation shall provide:

.1 switching on the DSC distress alert;

Transmission of the DSC distress alert shall have priority regarding any other operations;

.2 possibility acknowledgement of DSC distress alert reception;

.3 relay of the DSC distress alert;

.4 switching on the frequency 2182 and 2187,5 kHz. Tuners and controls for these frequencies shall be clearly marked;

.5 selecting the classes of emission J3E automatically when switching to the frequency 2182 kHz;

.6 selecting the classes of emission J2B or F1B automatically when switching to the frequency 2187,5 kHz.

.7 possibility of independent selecting transmission and reception frequencies of any receiver setting. This does not preclude the use of transceivers.

**6.2.27** Controls operation shall not cause unwanted emissions.

**6.2.28** Indication of transmission and reception frequencies shall be provided.

**6.2.29** Radio installation with manual tuning shall have a sufficient number of indicators providing fine and fast tuning.

**6.2.30** If the radio installation is required to be heated in order to operate correctly, the power supplies to the heating circuits shall be so arranged that they can remain operative when supplies to or within the installation are switched off.

A switch for the heating circuits shall be clearly indicated. It shall be protected against inadvertent switching on.

The correct operating temperature shall be reached within a period of 30 min after power supply.

**6.2.31** If it is necessary to delay power supply to any part of the transmitter after switching on, this delay shall be provided automatically.

### 6.3 MF/HF RADIO INSTALLATION

**6.3.1** The radio installation shall provide for the following categories of calls using both radiotelephony and digital selective call (DSC) for the purposes:

- .1 distress, urgency and safety;
- .2 ship operational requirements; and
- .3 public correspondence.

**6.3.2** The radio installation shall provide for the communication using both radiotelephony and narrow-band direct printing (NBDP) for the purposes:

- .1 distress, urgency and safety;
- .2 ship operational requirements;
- .3 public correspondence.

**6.3.3** If the radio installation is intended for distress alerts only or also for communication in distress and for safety, the requirements of 6.3.1.2, 6.3.1.3, 6.3.2.2 and 6.3.2.3 are not obligatory.

**6.3.4** The radio installation shall comprise:

- .1 a transmitter/receiver, including antenna;
- .2 an integral control unit or one or more separate control units with a telephone handset and an internal or external loudspeaker;
- .3 an integral or separate narrow-band direct-printing facility;
- .4 an integral or separate digital selective calling facility;
- .5 special receiver providing constant DSC watching on the frequencies 2187,5, 8414,5 kHz and at least on one of the distress frequencies and providing the safety in DSC system: 4207,5, 6312, 12577 or 16804,5 kHz. In any time the receiver shall be capable to select any of these distress frequencies and to provide the safety in DSC system.

**6.3.5** The transmitter shall be capable of transmitting within the frequency range of 1605 kHz to 27,5 MHz. Number of fixed frequencies shall be not less than 18: for radiotelephony — 2182; 4125; 6215; 8291; 12290; 16420 kHz; for NBDP — 2174,5; 4177,5; 6268; 8376,5; 12520; 16695 kHz; for DSC — 2187,5; 4207,5; 6312; 8414,5; 12577; 16804,5 kHz.

**6.3.6** The transmitter shall be capable of transmitting using classes of emission J3E and either J2B or F1B.

**6.3.7** The transmitter of radio installation shall be provided with a standard artificial aerial: C = 250 pF, R = 10 Ohm with series connection for MF range; R = 50 Ohm for HF range.

**6.3.8** During normal modulation, the peak envelope power in the class of J3E emission, or the mean output power of transmitter at the class of emission J2B or F1B shall be:

at least 60W at any frequency within operating range of frequencies;

not more than 400 W for MF range;

not more than 1500 W for HF range.

**6.3.9** If the mean output power of transmitter exceeds 400 W, provision shall be made for an automatic reduction to 400 W or less when transmitter is switched to MF range.

**6.3.10** The receiver shall be capable of being tuned within the frequency range of 1605 kHz to 27,5 MHz. Tuning shall be either continuous, or by incremental steps or by their combination. It is allowed to use the receiver tuned to the fixed frequencies which shall be not less than 18: for radiotelephony — 2182; 4125; 6215; 8291; 12290 and 16420 kHz; for NBDP — 2174,5; 4177,5; 6268; 8376,5; 12520 and 16695 kHz; for DSC — 2187,5; 4207,5; 6312; 8414,5; 12577 and 16804,5 kHz.

**6.3.11** The receiver shall be capable of receiving signals of the following classes of emission: J3E, H3E, J2B and F1B.

**6.3.12** The receiver frequency shall remain within 10 Hz of the required frequency following the wanning-up period.

**6.3.13** For classes of emission J3E and F1B the sensitivity of the receiver shall be equal to or better than 6  $\mu$ V e.m.f at the receiver input for a signal-to-noise ratio of 20 dB. For NBDP and DSC an output character error rate of  $10^{-2}$  or less shall be obtained for a signal-to-noise ratio of 12 dB.

**6.3.14** Adjacent-channel selectivity of the receiver shall exceed values given in Table 6.3.14.

Table 6.3.14

| Class of emission | Carrier frequency of unwanted signal distant from carrier frequency of valid signal by, kHz | Adjacent-channel selectivity   |
|-------------------|---|--|
| J3E               | -1 +4   | 40 dB  |
|                   | -2 +5   | 50 dB  |
|                   | -5 +8   | 60 dB  |
| H3E               | -10 +10   | 40 dB  |
|                   | -20 +20   | 50 dB  |
| F1B               | -0,5 +0,5   | 40 dB (analogue output); character error ratio $\leq 10^{-2}$ (digital output) |
|                   | -0,5 +0,5   |  |

Selectivity on spurious channels shall be not less than 60 dB.

Inter-modulation selectivity shall be not less than 70 dBmV for the class of emission F1B and not less than 80 dBmV for the class of emission J3E.

Blocking shall be not less than 65 dB when interference tuning out is  $\pm 20$  kHz.

Non-linear distortion factor of the receiver shall not exceed 7 per cent.

**6.3.15** The receiver shall be provided with an automatic gain control which effectiveness ensures alteration of the output voltage no more than by 10 dB if the input voltage varies by 70 dB.

**6.3.16** Radio installation receiver's output shall be designed for a loudspeaker power at least 2 W and a handset power 1 mW. Disconnection of a loudspeaker shall not affect the output sound power of a handset.

**6.3.17** If DSC encoder and NBDP device are not built-in, then additional unearthed outputs shall be provided for DSC and NBDP signals.

Output signals shall be 0 dB at a load of 600 Ohm regulated to the precision of  $\pm 10$  dB.

**6.3.18** The DSC facility shall be capable of decoding and encoding DSC formats, their composing and verifying.

**6.3.19** Indication in clear for understanding form shall be provided for the DSC formats received and being entered.

The size of the means to display information shall be such as to contain at least 160 characters in two or more lines.

**6.3.20** Provision shall be made for the means of automatic input of the ship's coordinates, the date and the time of their determination (see. 5.2.1.6).

**6.3.21** If the received messages are not printed immediately, sufficient capacity of memory shall be provided to enable at least 20 received distress messages to be stored in the DSC facility. These messages shall be stored until read-out.

These messages shall be erased 48 hours after they have been received.

**6.3.22** Self-identification data shall be stored in the DSC unit. It shall not be possible for the user easily to change these data.

**6.3.23** Means shall be provided to enable routine testing of the DSC facilities without radiation of signals.

**6.3.24** If the receiver with a scanning device capable of maintaining a continuous watch on more than one DSC distress channel is used, all selected channels shall be scanned within 2 s and the time of watching on each channel shall be sufficient for detecting a sequence of dots preceding to each DSC. Scanning shall only be terminated as soon as dots transmitted at a speed of 100 Baud are detected.

**6.3.25** The NBDP device shall be capable of operating in the circular and selective call modes on the single-frequency channels allocated for distress NBDP operation.

**6.3.26** The NBDP facility shall comprise:

**.1** means to decode and encode messages;

**.2** means for composing and verifying messages to be transmitted;

**.3** means for providing a record of received messages.

**6.3.27** Self-identification data shall be stored in the NBDP unit. It shall not be possible for the user easily to change these data.

**6.3.28** Possibility of controlling the radio installation from an integral control unit or separate control unit(s) shall be provided.

If two separate control units are available, priority shall be provided for the control unit at the position from which the ship is normally navigated.

**6.3.29** A control system for the radio installation shall provide:

**.1** switching on the DSC distress alert. Transmission of the DSC distress alert shall have priority regarding any other operations;

**.2** possibility of acknowledgement of DSC distress alert reception;

**.3** relay of the DSC distress alert;

**.4** switching on the frequency 2182 and 2187,5 kHz. Tuners and controls for these frequencies shall be clearly marked;

**.5** automatic selecting the class of emission J3E when switching to the frequency 2182 kHz;

**.6** automatic selecting the classes of emission J2B or F1B when switching to the DSC and NBDP distress and safety frequencies specified in 6.3.5 and 6.3.10;

**.7** possibility of selecting transmission and reception frequencies independent of any receiver setting. This does not preclude the use of transceivers.

**6.3.30** Controls operation shall not cause unwanted emissions.

**6.3.31** Indication of transmission and reception frequencies shall be provided.

**6.3.32** Radio installation with manual tuning shall have a sufficient number of instruments providing fine and fast tuning.

**6.3.33** If the radio installation is required to be heated in order to operate correctly, the power supplies to the heating circuits shall be so arranged that they can remain operative when supplies to or within the installation are switched off.

A switch for the heating circuits shall be clearly indicated. It shall be protected against inadvertent operation.

The correct operating temperature shall be reached within a period of 30 min after the application of power.

**6.3.34** If it is necessary to delay power supply to any part of the transmitter after switching on, this delay shall be provided automatically.

#### 6.4 INMARSAT SHIP EARTH STATION

**6.4.1** The ship earth station shall provide radio communication in the telephony mode and/or in the data (not voice data) transmission mode for the purposes of:

- .1 distress, urgency, safety and general radio-communications;
- .2 coordination of search and rescue operations;
- .3 transmitting navigational safety data.

**6.4.2** No controls external to the ship earth station shall be available for alteration of the ship station identity.

**6.4.3** It shall be possible to initiate and make distress alerts in the telephony mode and or in the data transmission mode from the position from which the ship is normally navigated and also from any other position designated for initiating of distress alerts. Where the space dedicated for radio communications is provided, the means for initiating a distress alert shall be installed in it.

The means for initiating a distress alert be as required in 5.2.1.7.

If no other receivers of the distress alerts, urgency and safety calls or devices for the distress alerts retry are provided, and the sound alarm level of telephone and printer during reception of these alerts is not sufficient, the ship earth station shall provide audible and visual signalling of the necessary level.

**6.4.4** If the ship earth station comprises the enhanced group calling (EGC) system its characteristics shall comply with the requirements for the EGC equipment specified in 8.2.

**6.4.5** The ship earth station shall be fitted with a self-monitoring system and capable of automatically initiating the audible and/or visual signalling in the following cases:

- .1 loss of observing the satellite by aerial,
- .2 failure of operability of the ship earth station,
- .3 loss of power supply or starting an emergency source of electrical power.

**6.4.6** The ship earth station shall provide the possibility of checking the distress alerting functions without transmitting the alerts.

**6.4.7** In addition to the requirements of the present Part of the Rules, the ship earth station shall meet the requirements and specifications of the INMARSAT and be of the type approved by the INMARSAT.

#### 6.5 DIRECT-PRINTING APPARATUS OF IMPROVED FIDELITY

**6.5.1** The direct-printing apparatus of improved fidelity (DPAIF) shall provide conversion from

5-character International Telegraph Alphabet ITU-T No. 2 to a 7-character code. DPAIF shall provide operation in the Forward-Error-Correcting (FEC) mode «B» and the Automatic error correction using an Automatic Request for Repeat or Retransmission «A» (ARQ) on the frequency channels allocated for distress and NBDP.

**6.5.2** Self-identification data shall be stored in the DPAIF unit.

**6.5.3** It shall not be possible for the user easily to change these data.

**6.5.4** DPAIF shall comprise:

- .1 means to decode and encode messages;
- .2 means for composing and verifying messages intended for transmission;
- .3 means for providing a record of received messages.

**6.5.5** DPAIF shall provide exchanging information between the mobile station and the subscribers of TELEX network.

#### 6.6 TERMINAL PRINTING DEVICE

**6.6.1** Terminal printing device shall use International Telegraph Alphabet No. 2 (ITU-T No. 2).

**6.6.2** Terminal printing device shall be provided with an apparatus recording all the signals transmitted or received. These signals may be not displayed if provided.

**6.6.3** Rated speed of operation of the terminal printing device shall be 50 or 100 Baud.

**6.6.4** Auto-reply code shall be transmitted by the apparatus capable to identify the signal "Who is there?" in the International Telegraph Alphabet No. 2 (ITU-T No. 2).

#### 6.7 FACSIMILE TERMINAL DEVICE

**6.7.1** Facsimile terminal device shall perform reception/transmission of the section-lined messages, graphical and text materials.

**6.7.2** Facsimile terminal device shall be able to self-copy the documents when the transmitter used.

**6.7.3** The image may be recorded both on a paper roll and on separate sheets of paper.

**6.7.4** Minimum allowable format of documents is A4.

**6.7.5** Surface of message shall be scanned in one direction both on a receiver and on a transmitter, if any.

**6.7.6** Facsimile terminal device shall be designed for round the clock operation.

**6.7.7** The device may be fitted with a memory.

## 6.8 INTEGRATED RADIO COMMUNICATION SYSTEM WHEN USED IN THE GMDSS

**6.8.1** The Integrated Radio Communication System (IRCS) is a system where individual radio communication equipment and installations are used as sensors i.e. without the need of their own control units providing outputs to and accepting commands from spaces called workstations for radio communications.

Such workstations are called GMDSS workstations, if they include control and monitoring of all equipment and installations provided on a ship for the GMDSS which are also suitable for general radio communication.

**6.8.2** The integrated radio communication system when used in the GMDSS (GMDSS IRCS) shall meet the following requirements:

**.1** functional requirements of the GMDSS. Along with that all functional requirements for each individual type of communication equipment and installation integrated in the IRCS shall be available.

No functional requirements for individual types of the communication equipment and installation shall impede fulfillment of any other functional requirements for other communication equipment or installation integrated in the radio communication system;

**.2** all functional requirements for the equipment integrated on the IRCS shall conform to the relevant regulations of technical and operational requirements for this equipment;

**.3** no single fault shall impair the operation of more than one radio communication sensor or more than one workstations for radio communication.

**6.8.3** The IRCS shall:

**.1** comprise at least two workstations for radio communication each connected to each GMDSS radio communication sensor over a network or connecting system;

**.2** comprise at least two printers;

**.3** have facilities for automatic updating of the ship's position and time, in addition to manual input of these data;

**.4** have a power supply arrangement which ensures that it is not possible to switch off inadvertently any part of the IRCS;

**6.8.4** GMDSS workstations shall:

**.1** have an identical user interface and an identical access to each function for different radio communication sensors;

**.2** be capable of allowing simultaneous operation of at least two radio communication sensors;

**.3** be capable of the transmission of distress alert initiated only by means of a dedicated button for each radio communication sensor and that button

shall be used for no other purpose. Each button shall be clearly identified and protected against inadvertent operation. The distress alert shall be initiated by two independent actions producing an indication that the alert has been activated.

Each button of the distress alert shall be electrically separated from the IRCS network or connecting system. It shall be possible to interrupt or initiate alerts at any time (see also 1.2).

**6.8.5** Integration of VHF radio telephone in the GMDSS IRCS is permitted only if it does not prevent compliance with the requirement of 3.4.4.

**6.8.6** Additional workstations for radio communication intended for general radio communications only shall have no access to the distress alerting functions and shall not impair the distress alerting.

The GMDSS workstations shall have priority access over additional workstations.

**6.8.7** Additional sensors not required for the GMDSS radio communication shall neither impair nor slow down the distress alerting and alarm functions.

## 6.9 VHF RADIOTELEPHONE STATION WITHIN FREQUENCY BAND OF 300,025 MHZ TO 300,500 MHZ AND 336,025 MHZ TO 336,500 MHZ

**6.9.1** The main VHF radiotelephone station shall ensure the radio communication within the frequency band of 300,025 MHz to 300,500 MHz; if only one main VHF radiotelephone station is provided on board, it will operate within the frequency band of 300,025 to 300,500 MHz and 336,025 MHz to 336,500 MHz.

The main VHF radiotelephone station shall be capable of operating on at least three frequencies including the calling and distress frequency of 300,2 MHz.

Operational VHF radiotelephone station shall ensure radio communication within the frequency band of 300,025 MHz to 300,500 MHz and 336,025 MHz to 336,500 MHz.

Portable VHF radiotelephone station may operate within the frequency band of 300,025 MHz to 300,225 MHz and 336,025 MHz to 336,225 MHz.

Interval between frequencies shall be 25 kHz.

**6.9.2** The class of emission shall be G3.

**6.9.3** The maximum deviation of frequency corresponding to 100 per cent depth of modulation shall be as close to  $\pm 5$  kHz as practicable and in no event shall exceed  $\pm 5$  kHz.

**6.9.4** The audio frequency bandwidth shall not exceed 3000 Hz.

**6.9.5** The rated power of a transmitter shall not be more than 15 W.

The transmitter shall be provided with a device capable of reducing power to 1 W.



**6.9.6** The sensitivity of the receiver shall be equal to or better than 1,5  $\mu$ V for a signal-to-noise ratio of 20 dB.

**6.9.7** The output of the receiver shall be designed for connecting a loudspeaker with power of at least 0,5 W and a telephone handset. The loudspeaker shall be integrated in the radio station case.

**6.9.8** Non-linear distortion factor of the receiver shall be not more than 7 per cent.

**6.9.9** The attenuation of signal reception on image frequency, intermediate frequency as well as that of other unwanted signals shall be not less than 80 dB.

**6.9.10** The bandwidth of the receiver on high (intermediate) frequency at a level of 6 dB shall be sufficient for receiving a signal with the maximum frequency deviation of 5 kHz.

**6.9.11** A device shall be provided capable of switching over the radio station on frequency 300,2 MHz (channel 5) when the microtelephone handset is placed in its regular position.

**6.9.12** The facility operating on frequency 300,2 MHz shall be provided ensuring the minimum power of 50 mW to the loudspeaker when a volume control is in zero position.

**6.9.13** The VHF radiotelephone station shall be provided with a squelch (mute) control.

**6.9.14** The VHF radiotelephone station shall be provided with a vertically polarized antenna.

**6.9.15** It is recommended to include in the VHF radiotelephone station set the devices permitting to maintain radio communications from the navigating bridge wings.

**6.9.16** Some technical requirements to the portable VHF radiotelephone station set out in the present Chapter may be changed upon agreement with the Register.

#### 6.10 RADIOTELEPHONE STATION FOR INTERIOR COMMUNICATION

**6.10.1** The radio station operating within the frequency band of 450 MHz to 470 MHz shall ensure the radio communication on operating frequencies of 457,525 MHz; 457,550 MHz; 457,575 MHz; 467,525 MHz; 467,550 MHz; 467,575 MHz with the interval between frequencies equal to 25 kHz, using the emission of G3 class.

Where the intervals between frequencies equal to 12,5 kHz the additional operating frequencies shall be as follows: 457,5375 MHz; 457,5625 MHz; 467,5375 MHz; 467,5625 MHz.

**6.10.2** If the relay station is needed on board, the following frequencies pairs shall be used:

- 457,525 MHz and 467,525 MHz;
- 457,550 MHz and 467,550 MHz;
- 457,575 MHz and 467,575 MHz.

**6.10.3** The rated power of a transmitter shall not be more than 2 W.

The transmitter shall have a device for reducing the power up to 0,2 W.

**6.10.4** The deviation of frequency shall not exceed  $\pm 5$  kHz with the interval between frequencies equal to 25 kHz and  $\pm 2,5$  kHz with the interval between frequencies equal to 12,5 kHz.

**6.10.5** A permissible relative deviation of frequency shall not exceed  $5 \cdot 10^{-6}$  with the interval between frequencies equal to 25 kHz and  $2,5 \cdot 10^{-6}$  with the interval between frequencies equal to 12,5 kHz.

**6.10.6** The audio frequency bandwidth shall not exceed 3000 Hz with the interval between frequencies equal to 25 kHz and 2600 Hz with the interval between frequencies equal to 12,5 kHz.

#### 6.11 TWO-WAY VHF RADIOTELEPHONE APPARATUS FOR COMMUNICATIONS WITH AIRCRAFTS

**6.11.1** The apparatus shall be portable and capable of being used for on-scene communication between ship and aircraft.

**6.11.2** The apparatus shall comprise at least:

- .1 an internal transmitter/receiver, including antenna and source of power;
- .2 an integral control unit with a press-to-transmit switch;
- .3 a microphone and loudspeaker.

**6.11.3** The apparatus shall:

- .1 be capable of being operated by unskilled personnel;
- .2 withstand drops on to a hard surface from a height of 1 m;
- .3 be of small size and light weight;
- .4 be capable of operating in the ambient noise level likely to be encountered during search and rescue works using aircrafts;
- .5 be of a colour different to colour of the two-way VHF radiotelephone apparatus (see 12.2.3.13);
- .6 be capable of operation on the frequency 121,5 MHz and 123,1 MHz. Its class of emission shall be A3E;
- .7 have an on/off switch with a visual indication that the installation is switched on;
- .8 have a manual volume receiver control by which the audio output may be varied;
- .9 provide an easy channel selection switch. Channel shall be clearly discernible;
- .10 be ready for operation not later than 5 s after activation.

**6.11.4** The carrier power of a radio transmitter shall be between 50 mW and 1,5 W.

**6.11.5** The audio output shall be sufficient to be heard in the ambient acoustic noise level likely to be

encountered during search and rescue works using aircrafts.

**6.11.6** In the transmit condition the receiver output sound signal shall be muted.

**6.11.7** The source of electrical power shall be a primary power supply battery integrated in the equipment, which may be replaced during operation. In addition, it may be possible to operate the apparatus from an alternative source of electrical power.

**6.11.8** Primary power supply batteries shall have the period of storage not less than 2 years and shall be replaced if on the date of survey of the shipboard radio equipment carried out by the Surveyor to the Register the period of their storage left is at least 12 months.

**6.11.9** In addition to the requirements of 5.1.48 the following shall be clearly indicated on the exterior of the equipment:

- .1 brief operating instruction;
- .2 the ship's name and call signal;
- .3 "Intended for connection with aircrafts only".

#### 6.12 STATIONARY TWO-WAY VHF RADIOTELEPHONE APPARATUS FOR COMMUNICATIONS WITH AIRCRAFTS

**6.12.1** The apparatus shall be capable of being used for on-scene communication between ship and airborne rescue unit (s).

**6.12.2** The apparatus shall comprise at least:

- .1 transmitter/receiver;
- .2 antenna which may be fitted on the equipment or isolated;
- .3 a microphone with a press-to-transmit switch.

**6.12.3** The apparatus shall:

- .1 be capable of being operated by unskilled personnel;
- .2 be capable of operating in the ambient noise level likely to be encountered onboard of a ship;

.3 have an on/off switch with a visual indication that the installation is switched on;

.4 have a manual volume receiver control by which the audio output may be varied;

.5 provide an easy channel selection switch. Channel shall be clearly discernible;

.6 be ready for operation not later than 5 s after activation;

.7 be capable of operation on the frequency 121,5 MHz and 123,1 MHz.

Its class of emission shall be A3E.

**6.12.4** The carrier power of a radio transmitter shall be between 50 mW and 1,5 W.

**6.12.5** The audio output shall be sufficient to be heard in the ambient acoustic noise level onboard a ship in a place of apparatus installation.

**6.12.6** In the transmit condition, the receiver output sound signal shall be muted.

**6.12.7** The apparatus shall be powered from the ship's main and emergency source of electrical power.

Instead of the aforesaid, the apparatus may be power supplied from the built-in primary power supply battery, which may be replaced when operating.

**6.12.8** Primary power supply batteries shall have the period of storage not less than 2 years and shall be replaced if on the date of survey of the shipboard radio equipment carried out by the Surveyor to the Register the period of their storage left is at least 12 months.

**6.12.9** In addition to the applicable requirements of 5.1.48 the following shall be clearly indicated on the exterior of the equipment:

- .1 brief operating instructions;
- .2 the ship's name and call signal;
- .3 expiry date for the primary battery stored, if applicable;
- .4 "Intended for emergency connection with aircrafts only".

## 7 SHIP SECURITY EQUIPMENT

### 7.1 SHIP SECURITY ALERT SYSTEM

**7.1.1** The ship security alert system, when activated, shall provide generating and transmitting to the shore a security alert or a special report indicating that the security of the ship is under threat or has been compromised.

The alert transmitted by the system shall be addressed only to a designated competent organization and shall not be received by other ships.

**7.1.2** The functions of the ship security alert system may be effected using the following equipment:

- .1 GMDSS installation;

.2 radio equipment installed in addition to that required in 2.2.1 and intended for general communications;

.3 systems specially designed for security alert purposes.

**7.1.3** The mode of transmitting a ship security alert by the security alert system shall not cause any alarm or indication to be raised on the ship.

**7.1.4** Provision shall be made for at least two activation points, one of which shall be located on the navigating bridge. The location of another one shall be known only for the limited number of the ship crew specified in the ship security plan.

A special button, handset, keyboard, switch or other technical means located and designed so as to

protect them against inadvertent operation and actuating a false signal on the ship security threat may be used as the activation device of the ship security alert system.

**7.1.5** In order to activate the ship security alert system, it shall not be necessary for the user to remove seals, to break any lid or cover, to switch on additional blocks.

**7.1.6** The radio equipment transmitting the alert on a ship security threat shall be so designed that its bringing into operation by the signal of the security alert system activation device does not require the preliminary selection of operational modes, tuning of channels or setting of menu options.

The connection of the GMDSS installation to the ship security alert system for transmitting the alert on a ship security threat shall not impair the functionality of the GMDSS installation as required in this Part of the Rules.

**7.1.7** The alert on a ship security threat generated with ship security alert system activation shall be continuously transmitted and include a unique code/identity indicating that the alert has not been generated in accordance with the GMDSS distress procedures. The ship security alert shall be continuously transmitted until the ship security alert system is deactivated and/or reset.

**7.1.8** The ship security alert shall include the ship identity and current position associated with a date and time.

**7.1.9** The design of the ship security alert system shall provide for a possibility to periodically check operability without transmitting the ship security alert.

In all cases, the check shall not lead to unpredicted effects as the result of emergency response.

## **7.2 SHIP SECURITY SURVEILLANCE TV SYSTEM**

**7.2.1** The ship security surveillance TV system shall ensure remote surveillance within the guarded areas and/or outside the guarded spaces, the transmission of visual and, where needed, voice data on condition of the surveillance areas and spaces to the navigating bridge and/or to a space intended for watch keeping during the ship's stay at port, if it is provided in the ship security plan.

**7.2.2** The ship security surveillance system may be used for visual surveillance of technological operations (loading, unloading, mooring etc.) carried out within the guarded areas.

**7.2.3** The ship security surveillance system shall include TV cameras as well as the following means:

**.1** for displaying the visual information (visual display units);

**.2** for recording and storing visual data (video recorders);

**.3** for control and switching of visual signals;

**.4** for motion detection (if needed).

In addition to the above, the ship security surveillance system may include the means for recording, displaying and storage of the voice data.

**7.2.4** The ship security surveillance TV system shall ensure, at least, the following:

**.1** generation and transmission of visual data;

**.2** distribution of visual signals and displaying the condition of guarded areas and spaces;

**.3** processing the signals (multiplexing, video-recording and sound-recording (where provided));

**.4** displaying the recorded data.

**7.2.5** The ship security surveillance system may have a black-and-white or color display proceeding from the required information content level of the surveillance system as well as from the location and lighting of surveillance areas, physical state of the prospective mobile objects.

**7.2.6** TV camera of the security surveillance TV system shall transmit a video signal with a signal-to-noise ratio of at least 50dB.

**7.2.7** Horizontal resolution capability of a TV camera shall be at least 300 television lines for a color and black-and-white image with the image dimension ratio complying with the standard ones (3: 4; 9:16 and etc.).

**7.2.8** The surveillance TV system camera shall be capable of transmitting a video signal with a minimum lighting of the TV surveillance area of not more than 5 lux, and with the maximum lighting not less than 50000 lux.

If the actual lighting of the surveillance area is less than the TV camera sensitivity, then this surveillance area or object shall be provided with an additional lighting, or the ship security surveillance TV system shall be provided with an infrared sensitive camera (cameras).

Where the color ship security TV surveillance system is used, infrared cameras are not recommended for use.

Object-detection sensitivity of TV cameras shall be such as to provide detection of objects of 30x30cm within the surveillance area (the extreme edge of the detection area).

**7.2.9** TV cameras shall ensure surveillance of the whole surveillance area and shall be so installed as to overlap the adjacent areas.

The design of TV cameras installed on the open deck shall provide the possibility to fit a protective cover or a camera lens cleanup device.

**7.2.10** The design of the ship security surveillance TV system shall ensure full-time operation.

**7.2.11** The diameter of black-and-white and color display shall be of at least 360 mm (diagonally). With

that, horizontal resolution capability of cathode-ray identities shall be at least 500 television lines for a black-and-white image and at least 400 television lines for color image. For LCDs the resolution capability shall be of at least 640 × 480 pixels.

**7.2.12** For the purpose of recording visual data video recorders or digital still stores shall be used. It is allowed to use audio recording, where needed, concurrently with the video recording.

**7.2.13** The ship security surveillance TV system shall ensure search, displaying (viewing), copying and transmission of the information recorded on the external data medium.

**7.2.14** Search and displaying of the recorded video data with no record interruption shall be carried out as follows:

- .1 step-by-step search/ viewing of images in a "back", "forward" or "picture stop" mode;
- .2 full-screen viewing of video data recorded by an individual TV camera on a display in the "back", "forward" or "stop image" mode; with adjustable zoom;
- .3 simultaneous "picture-in-picture" viewing of video data recorded by the two individual TV cameras on a display in the "back", "forward" or "stop image" mode;
- .4 simultaneous viewing of video data recorded by several TV cameras on a display in the "back", "forward" or "stop image" mode;

.5 full-screen sequential viewing of the video data recorded by the individual TV cameras on a display in the "back", "forward" or "stop image" mode.

**7.2.15** Means of control and switching of video signals shall ensure the priority automatic displaying of a surveilled area (areas), where the motions have been detected (if a motion sensor is provided).

**7.2.16** The ship security surveillance TV system shall ensure visual and audible signalling in cases of:

- .1 motion detection in a surveilled area or space (if motion sensors are provided);
- .2 failure of the ship's main source of electrical power or switching on the emergency source of electrical power;
- .3 failure of the ship security surveillance TV system;
- .4 failure (short circuit, breaking of circuit) of a «TV camera — display» channel;
- .5 failure of a TV camera;
- .6 failure of motion sensors;
- .7 failure of a video recorder and, where applicable, audio recorder.

**7.2.17** The ship security surveillance TV system shall be provided with a complete set of a special emergency accumulator battery to be used in case of failure of the ship's main source of electrical power or provision shall be made for the emergency source of uninterruptible electrical power ensuring off-line operation of the ship security surveillance TV system within at least 1 h.

## 8 FACILITIES FOR RECEPTION OF MARITIME SAFETY INFORMATION

### 8.1 NAVTEX RECEIVER

**8.1.1** The equipment shall consist of two radio receivers, a signal processing device and one of the following devices:

- .1 an integrated printing device; or
- .2 a display facility with standard output port for printer and non-volatile message memory; or
- .3 a connection to an integrated navigation system and a non-volatile message memory.

**8.1.2** NAVTEX receiver shall provide the reception of information for areas covered by the service and for message categories excluded by the operator from the reception and/or a display facility shall always be available.

**8.1.3** The set of equipment shall contain one NAVTEX receiver operating on the frequency 518 kHz of the International NAVTEX service, and a second receiver capable of working at the same time as the first one on at least two other frequencies intended for the transmission NAVTEX data.

**8.1.4** The receiver operating on the frequency 518 kHz shall have priority in the display or printing of received information.

Printing or displaying of messages received by one of the two receivers shall not prevent reception by both receivers of NAVTEX equipment.

**8.1.5** Each NAVTEX receiver shall ensure recording at least 200 messages of average length 500 characters in non-volatile message memory (printed and non-printed). It shall not be possible for the user to erase messages from memory. When the memory is full, the oldest messages shall be overwritten by new messages.

**8.1.6** The user shall be able to tag individual messages for permanent retention. These messages may occupy up to 25 per cent of the available memory and shall not be overwritten by new messages. When no longer required, the user shall be able to remove the tag on these messages which may then be overwritten in normal course.

**8.1.7** NAVTEX receiver shall be provided with a facility to test that the radio receiver, and proceeding

from what equipment is available, the display facility, printer and non-volatile message memory are functioning correctly.

**8.1.8** The equipment shall be capable of internally storing at least 200 message identifications for each receiver provided. When the time between 60 h and 72 h elapses, the message identification shall automatically be erased from the store. If the number of received message identifications exceeds the capacity of the store, the oldest message identification shall be erased.

**8.1.9** Only message identifications that are satisfactorily received shall be stored; a message is satisfactorily received if the character error rate is below 4 per cent.

**8.1.10** The receipt of search and rescue information shall give an alarm at the position from which the ship is normally navigated. This alarm shall be reset (acknowledged) manually only.

**8.1.11** Information for location and message designators in programmable memories shall not be erased by interruptions in the power supply of 6 h.

**8.1.12** The receiver sensitivity shall be such that for a source with an e.m.f. of 2 V in series with a non-reactive impedance of 50 Ohm, the character error rate is below 4 per cent.

**8.1.13** The display facility and/or printer shall be able to display a minimum of 32 characters per line.

**8.1.14** If a display facility is used in NAVTEX receiver, the following requirements shall be met:

**.1** an indication of newly received messages shall be immediately displayed until acknowledged by the staff or until 24 h after receipt;

**.2** newly received messages shall also be displayed;

**.3** where there is no printer, the display facility shall be located in the position from which the ship is normally navigated.

**8.1.15** The display facility shall be able to display at least 16 lines of message text.

**8.1.16** The design and size of the display facility shall be such that displayed information is easily read under all conditions by observers at normal working distances and viewing angles.

**8.1.17** If automatic line feed entails division of a word, this shall be indicated in the displayed/printed text.

**8.1.18** When displaying received messages on a display facility, a clear indication of the end of a message shall be given by automatically adding line feeds after the message or including some other form of delineation.

The printer or printer output shall automatically insert line feeds after completing print of the received message.

**8.1.19** The equipment shall display/print an asterisk if the character is received corrupted.

**8.1.20** Where the printer is not integrated, it shall be possible to select the following data to be put out to the printer:

**.1** all messages as they are received;

**.2** all messages stored in non-volatile message memory;

**.3** all messages received on specified frequencies, from specified locations or having specified message designators;

**.4** all messages currently displayed; and

**.5** individual messages selected from those appearing on the display.

At the same time, NAVTEX receiver shall include a standard interface for connection with the printer.

**8.1.21** NAVTEX receiver shall include at least one interface for the transfer of received data to other navigation or communication equipment.

**8.1.22** All interfaces provided in NAVTEX receiver shall ensure compliance with the formats specified in relevant international standards for communication with marine navigation or communication equipment.

## 8.2 ENHANCED GROUP CALLING RECEIVER

**8.2.1** EDG receiver may be constructed as a separate device or combined with other equipment. Components of the other equipment such as aerial, low-noise amplifier and frequency converter of the ship earth station may be used as a component of the receiver.

**8.2.2** The equipment shall be capable of printing out the received information. The received messages may be stored in a memory with indication that the message has been received for subsequent printing out except for the messages specified in 8.2.4 and 8.2.7 which shall be printed out immediately after their reception.

**8.2.3** Means shall be provided for manually entering ship's position data and geographical area code so that area group calls can be received. In addition, automatic entry of the ship's position data by the navigational equipment and automatic conversion of ship's position data into the geographical area code shall be provided.

**8.2.4** An audible and visual signalling system shall be provided at the position from which the ship is normally navigated in order to indicate reception of distress or urgency calls or a call having distress category.

The signalling system shall be incapable of being switched off and have a possibility of manual resetting an audible signal.

**8.2.5** Indication shall be provided in the equipment for incorrect tuning to the carrier frequency of the EGC or for the absence of synchronization.

**8.2.6** Any message shall be printed out regardless of the character error rate during reception. If a character is received in a mutilated form, the equipment shall print a low line mark.

**8.2.7** The operator shall control acceptance or rejection from printing service codes except for cases when the equipment shall have no possibility to reject relevant navigational and meteorological warnings, search and rescue information and certain special warnings which are directed to the geographical area where the ship is operating.

**8.2.8** The equipment shall not print out the same message after it has been received without errors.

**8.2.9** The printer shall be capable of printing not less than 40 characters per line.

**8.2.10** The signal processing device and the printer shall be capable of transferring a word to the next line if it cannot be fully accommodated on one line. Upon termination of message printing, the printer shall provide an automatic fivefold line feed.

**8.2.11** In addition to the requirements of these Rules, the EGC receiver shall meet the requirements and specifications of the INMARSAT and be of the type approved by the INMARSAT.

### **8.3 HF DIRECT-PRINTING TELEGRAPH RECEIVER FOR RECEPTION OF MARITIME SAFETY INFORMATION**

**8.3.1** The equipment of a narrow-band direct-printing telegraphy for reception of maritime safety information shall consist of a receiver, signal processing device, printer and means providing frequency retuning manually and automatically.

**8.3.2** The receiver shall operate on the frequencies 4210; 6314; 8416,5; 12579; 16806,5; 19680,5; 22376; 26100,5 kHz. Additional frequencies may be provided intended for the International and National NAVTEX services (518, 490 and 4209,5 kHz).

**8.3.3** Provision shall be made for operability check of the receiver, signal processing device, printer and means for automatic frequency retuning, if provided.

**8.3.4** The equipment shall be capable of storing at least 255 message identifications. After between 60 and 72 h a message identification shall automatically be erased from the memory of equipment. If the number of received messages exceeds the memory

capacity the oldest message identification shall be erased automatically.

**8.3.5** An audible and visual signalling system shall be provided at the position from which the ship is normally navigated in order to indicate reception of search and rescue messages.

The signalling system shall be incapable of being switched off and have a possibility of manual resetting.

**8.3.6** Information for areas covered by the service and for message categories stored in the equipment memory shall not be erased in the event of supply voltage failure during a period of up to 6 h.

**8.3.7** The sensitivity of the receiver shall be so that for a source having an electromotive force of 6  $\mu\text{V}$  a character — error rate was not more than  $10^{-2}$ .

**8.3.8** The operator shall control acceptance or rejection from printing service codes except for cases when the equipment shall have no possibility to reject relevant navigational and meteorological warnings, search and rescue information and certain special warnings which are transmitted by the shore-based radio station in the area of ship location.

**8.3.9** Information for areas covered by the service and for message categories excluded by the operator from reception shall be provided.

**8.3.10** Only those messages shall be stored in the equipment the identifications of which have been received without errors.

**8.3.11** The equipment shall not print out the same message after it has been received without errors. The message is considered to be received correctly if the character to error rate is less than 4 per cent.

**8.3.12** The printer shall be capable of printing not less than 32 characters per line.

**8.3.13** The signal processing device and the printer shall be capable of transferring a word to the next line if it cannot be fully accommodated on one line.

Upon termination of message printing, the printer shall automatically provide sufficient multiplicity of line feed.

**8.3.14** If a character is received in a mutilated form, the equipment shall print an asterisk.

**8.3.15** Where the equipment comprises means for automatic retuning of the receiver's frequency, the universal coordinated time (UTC) clock shall be provided with an accuracy of  $\pm 1$  s, which shall be connected to a reprogrammable memory containing the frequency sequence and UTC broadcast schedules of all radio stations transmitting HF maritime safety information using NBDP.

## 9 EMERGENCY POSITION-INDICATING RADIO BEACONS

### 9.1 GENERAL

**9.1.1** The emergency position indicating radio beacon (EPIRB) shall be automatically activated after floating free.

The EPIRB its mounting and releasing arrangements shall be reliable under extreme ship's conditions.

**9.1.2** The EPIRB shall:

**.1** be easily activated by unskilled personnel and transferred to the survival craft by one person;

**.2** be fitted with adequate means to prevent inadvertent activation;

**.3** be so designed that the electrical portions are watertight at a depth of 10 m for at least 5 min;

**.4** be capable of withstanding temperature variation of 45 °C during its immersion.

The harmful effects of a marine environment, condensation and water leakage shall not affect the performance of the beacon;

**.5** be capable of manual activation and manual deactivation;

**.6** be provided with means to indicate that signals are being emitted;

**.7** be capable of floating upright in calm water and have positive stability and sufficient buoyancy in all sea conditions;

**.8** be capable of being dropped into the water without damage from a height of 20 m;

**.9** be of highly visible yellow/orange colour and have a paint or stripes of retroreflecting material;

**.10** be equipped with a buoyant lanyard suitable for use as a tether, which shall be so arranged and not attached to the ship's hull or EPIRB securing device as to prevent its being trapped in the ship's structure when floating free;

**.11** be provided with a light (0,75 cd) automatically activated by darkness to indicate its position;

**.12** be resistant to seawater and oil;

**.13** be resistant to deterioration in prolonged exposure to sunlight.

**9.1.3** The EPIRB shall be so designed as to operate under any of the following environmental conditions:

**.1** ambient temperatures of  $-20\text{ °C}$  to  $+55\text{ °C}$ ;

**.2** icing;

**.3** relative wind speeds up to 100 knot (51 m/sec);

**.4** after storage at temperatures between  $-30\text{ °C}$  and  $+70\text{ °C}$ .

**9.1.4** The EPIRB shall be so constructed that it can be ready for the operation during at least one year without maintenance.

**9.1.5** The installed EPIRB shall be designed to release itself and float free, when immersed to the depth of 4 m, at any angle of a list or trim.

**9.1.6** The release and activation arrangements for EPIRB shall comply with the requirements of Section 15.

**9.1.7** The installed EPIRB shall have local manual activation; remote activation may also be provided from the navigating bridge while the device is installed in the floatfree mounting.

**9.1.8** Self-floating COSPAS-SARSAT satellite EPIRB shall be so designed as to be automatically activated when immersed to the water after being manually removed from the release mechanism; when manually activated it shall require two independent actions (see 1.2).

**9.1.9** When the satellite EPIRB of the COSPAS-SARSAT and INMARSAT systems is manually operated, a distress alert shall be initiated, as stated above, only by means of a dedicated distress alert activator and shall require two independent actions.

The dedicated activator shall be clearly identified and be protected against inadvertent operation.

The COSPAS-SARSAT satellite EPIRB shall not be automatically activated after being manually removed from the release mechanism.

**9.1.10** For periodical testing of the EPIRB in action using an artificial aerial provision shall be made for connection to it of the external source of power.

**9.1.11** The COSPAS-SARSAT satellite EPIRB shall:

**.1** undergo annual overall operational efficiency testing with due regard to emission on working frequencies, encoding and recording within the following time limits:

on passenger ships — within 3 months before the expiry of validity of the Passenger Ship Safety Certificate;

on cargo ships — within 3 months before the expiry of validity of the Cargo Ship Safety Radio Certificate or within 3 months before or after annual expiry of validity of this Certificate.

The testing may be carried out on board or at the shore-based maintenance center recognized by the Register; and

**.2** undergo maintenance and repair at the shore-based maintenance center recognized by the Register at least once every five years.

**9.1.12** Primary batteries used as a source of electrical power for the EPIRB shall have the period of storage not less than 2 years and shall be replaced if on the date of survey of the shipboard radio

equipment carried out by the Surveyor to the Register the period of their storage left is at least 12 months. Date of manufacture and maximum period of storage shall be indicated on the batteries.

**9.1.13** In addition to 5.1.47, the following shall be clearly indicated on the exterior of the EPIRB:

- .1** brief operating instructions in the English and in the national languages;
- .2** expiry date for the primary battery stored;
- .3** identification code.
- .4** date of occasional shore-based maintenance;
- .5** the ship's call signal.

## **9.2 COSPAS-SARSAT SATELLITE EMERGENCY POSITION-INDICATING RADIO BEACONS**

**9.2.1** The satellite EPIRB shall be capable of transmitting a distress alert to polar orbiting satellites.

**9.2.2** Check of the EPIRB shall be provided without using the satellite system.

**9.2.3** The satellite EPIRB distress alerting signal shall be transmitted on the frequency of 406,028 MHz  $\pm$  1 kHz using G1B class of emission.

**9.2.4** The satellite EPIRB shall be provided with a frequency of 121,5 MHz for aircraft homing.

The homing signal shall:

**.1** be transmitted using class of emission. Carrier frequency shall be amplitude-modulated (minimum duty cycle of 33 per cent) with a minimum modulation index 0,85. The emission shall consist of a characteristic audio-frequency signal obtained by amplitude modulation of the carrier frequencies with a downward/ upward audio-frequency sweep within a range of not less than 700 Hz between 1600 Hz and 300 Hz and with a sweep repetition rate of 2 to 4 times per second;

**.2** capacity of carrier frequency shall differ at least 30 per cent from that of sidebands and be within 30Hz at any time;

**.3** have an uninterruptible duty cycle which can be interrupted for 2 seconds maximum for the transmission of signal on 406,028 MHz.

**9.2.5** Provisions shall be included for storing the fixed portion of the distress message in the satellite EPIRB using non-volatile memory.

**9.2.6** A unique beacon identification code shall be made part of all messages, including three digits of the code of the country of registration followed by:

- .1** a unique serial number; or
- .2** a radio call sign; or
- .3** six figures of the ship identity.

Preference shall be given to 9.2.6.3.

**9.2.7** COSPAS-SARSAT satellite EPIRB, in addition to the requirements specified in the present Part of the Rules, shall comply with the COSPAS-SARSAT and be type approved by the COSPAS-SARSAT.

## **9.3 VHF EMERGENCY POSITION-INDICATING RADIO BEACONS**

**9.3.1** The EPIRB shall be capable of transmitting a VHF distress alert and of providing a homing signal by means of a 9 GHz radar transponder. These two functions may be provided in an integral unit. The radar transponder shall comply with the requirements of Section 10.

**9.3.2** The EPIRB shall be of an automatic, float-free type and shall be capable of being tested on board, without radiating an alerting signal.

**9.3.3** The EPIRB shall comply with the following requirements:

**.1** DSC distress alerting signal shall be transmitted on the frequency of 156,525 MHz using G2B class of emission;

**.2** the frequency tolerance shall not exceed  $10 \cdot 10^{-6}$ ;

**.3** the bandwidth shall be less than 16 kHz;

**.4** the output power shall be at least 100 mW;

**.5** emission shall be vertically polarized;

**.6** frequency modulation with a pre-emphasis characteristic of 6 dB/octave (phase modulation) with the modulating subcarrier shall be used;

**.7** a subcarrier of 1700 Hz with frequency modulation between 1300 and 2100 Hz shall be used;

**.8** the frequency tolerance of 1300 and 2100 Hz shall be within  $\pm 10$  Hz;

**.9** the modulation rate shall be 1200 Baud;

**.10** the index of modulation shall be  $2 \pm 10$  per cent.

**9.3.4** DSC format and sequence of DSC alerting shall comply with the following standards.



## 10 SHIP AND SURVIVAL CRAFT RADAR TRANSPONDERS

### 10.1 GENERAL

**10.1.1** The radar transponder shall be capable of indicating the location of units in distress by transmitting signals which will appear on a radar display as a series of equally spaced dots.

**10.1.2** The radar transponder shall:

**.1** be capable of being easily activated by unskilled personnel;

**.2** be fitted with means to prevent inadvertent activation;

**.3** be equipped with a means which is either visual or audible, or both visual and audible, to indicate correct operation and to alert survivors to the fact that a radar has triggered the radar transponder;

**.4** be capable of manual activation and deactivation; provision for automatic activation may be included.

If an on board test is performed using a shipborne 9 GHz radar, activation of the radar transponder shall be limited to a few seconds to avoid harmful interference to other shipborne or airborne radars and excessive consumption of source power;

**.5** be provided with an indication of the stand-by condition;

**.6** be capable of withstanding without damage drops from a height of 20 m into water;

**.7** be watertight at a depth of 10 m for at least 5 min;

**.8** maintain watertightness when subjected to a thermal shock of 45 °C under specified conditions of immersion;

**.9** be capable of floating if it is not an integral part of the survival craft;

**.10** be equipped with a buoyant lanyard, suitable for use as a tether, if it is capable of floating;

**.11** be resistant to seawater and oil;

**.12** be resistant to deterioration in prolonged exposure to sunlight;

**.13** be of a highly visible yellow/orange colour on all surfaces where this will assist detection;

**.14** have a smooth external construction to avoid damaging the survival craft.

**10.1.3** The radar transponder shall be so designed as to be able to operate under temperatures of –20 °C to +55 °C. It shall not be damaged in storage throughout the temperature range of –30 °C to +65 °C.

**10.1.4** The height of the installed transponder antenna shall be at least 1 m above sea level.

In order to fulfill this requirement provision shall be made for a pole or other arrangement compatible with the antenna pocket in a survival craft, together with illustrated instructions.

**10.1.5** The vertical antenna polar diagram and hydrodynamic characteristics of the device shall permit the radar transponder to respond to search radars under heavy swell conditions. The antenna polar diagram shall be substantially omnidirectional in the horizontal plane. Horizontal polarization shall be used for transmission and reception.

**10.1.6** The radar transponder shall operate correctly when interrogated at a distance of up to at least 5 nautical miles by a navigational radar with an antenna height of 15 m.

It shall also operate correctly, when interrogated at a distance of not less than 30 nautical miles by an airborne radar with at least 10 kW peak output power at a height of 1000 m.

**10.1.7** In addition to 5.1.47, the following shall be clearly indicated on the exterior of the radar transponder:

**.1** brief operating instructions;

**.2** the ship's name and call sign;

**.3** expiry date for storage of the primary battery used (see 9.1.12).

## 11 PUBLIC ADDRESS SYSTEM

### 11.1 GENERAL

**11.1.1** Public address system shall be capable of providing the possibility for transmitting the service orders from the command microphone posts to all service, accommodation and public spaces as well as to the open decks of the ship.

Public address system shall be capable of providing the possibility of interrupting any broadcasting from any command microphone post or the transmission of general radio broadcasting and sound-recording programs from the navigating bridge.

It is allowed to use the ship public address system for transmitting general radio broadcasting and sound-recording programs, if the priority of loudspeaking and command broadcasting is provided.

Automatic brake of transmitting general radio broadcasting and sound-recording programs shall be provided when ship's general alarm system is in operation.

**11.1.2** For the transmission of the service orders all control of the public address system (switching on and off, commutation of the broadcasting relay lines, disconnection of programs and switching on a public

address system) shall be carried out by remote control means directly from any of command microphone posts irrespective of the position of controls in all other command microphone posts.

**11.1.3** The public address system shall be capable of being connected to at least three broadcasting lines.

**11.1.4** The public address system shall include the main command microphone post intended for installation in the ship command broadcasting centre, and at least two remote microphone posts. The main command microphone post shall be provided with means for audio control of the quality of broadcast in each broadcasting line.

**11.1.5** Every command microphone post shall be fitted with light signalling system which shall be switched on simultaneously with the starting of the public address system.

The diagram of the remote control switching system shall be as simple as possible, preferably, without using relays.

**11.1.6** Loudspeakers installed in accommodation spaces of the ship shall be fitted with volume controls. Plugs are not allowed to be used.

## 12 SURVIVAL CRAFT RADIO EQUIPMENT

### 12.1 RADAR TRANSPONDERS

**12.1.1** The radar transponder shall comply with the requirements of Section 10.

### 12.2 TWO-WAY VHF RADIOTELEPHONE APPARATUS

**12.2.1** The apparatus shall be capable of being used for on scene communication between survival craft, between survival craft and ship and between survival craft and rescue unit. It may also be used for on-board communications when capable of operating on appropriate frequencies.

**12.2.2** The apparatus shall constitute an integral device and comprise at least the following:

**.1** an integral transmitter/receiver including antenna and power source;

**.2** a push-button control unit for receipt/transmission;

**.3** an internal microphone and loudspeaker.

**12.2.3** The apparatus shall:

**.1** be capable of being operated by unskilled personnel;

**.2** be capable of being operated by personnel wearing gloves;

**.3** be capable of single-handed operation except for channel selection;

**.4** withstand drops on to a hard surface from a height of 1 m;

**.5** be watertight to a depth of 1 m for at least 5 min;

**.6** maintain watertightness when subjected to a thermal shock of 45 °C under conditions of immersion;

**.7** not be unduly affected by seawater or oil;

**.8** have no sharp projections which could damage survival craft;

**.9** be of small size and light weight;

**.10** be capable of operating in the ambient noise level likely to be encountered on board ships or in survival craft;

**.11** have provisions for its attachment to the clothing of the user and also be provided with a wrist or neck strap. For safety reasons, the strap shall include a suitable weak link;

**.12** be resistant to deterioration by prolonged exposure to sunlight;

**.13** be painted in yellow or orange colour or have an marking strip of yellow (orange) colour around the apparatus.

**12.2.4** The apparatus shall be capable of operation on the frequency 156,800 MHz (VHF channel 16) and on at least one additional channel.

**12.2.5** Simplex radiotelephone channels shall be used in the apparatus.

**12.2.6** The class of emission shall be G3E.

**12.2.7** An on/off switch shall be provided with a visual indication that the radiotelephone is switched on.

**12.2.8** The receiver shall be provided with a volume control.

**12.2.9** A squelch (mute) control and a channel selection switch shall be provided.

**12.2.10** Channel selection shall be easily performed and the channels shall be clearly discernible.

**12.2.11** It shall be possible to determine that channel 16 has been selected in all ambient light conditions.

**12.2.12** The apparatus shall be ready for operation not later than 5 s after activation.

**12.2.13** The effective radiated power of transmitter shall be at least 0,25 W. Where the effective radiated power exceeds 1 W, a power reduction switch to reduce the power to 1 W or less is required. When this equipment provides for on-board communications, the output power of transmitter shall not exceed 1 W.

**12.2.14** The sensitivity of the receiver shall be equal to or better than  $2 \mu\text{V e.m.f}$  for a SINAD ratio of 12 dB on the transmitter output. The immunity to interference of the receiver shall be such that the unwanted signals do not effect adversely the wanted signal.

**12.2.15** The antenna shall be vertically polarized and, as far as practicable, be omnidirectional in the horizontal plane.

**12.2.16** The audio output shall be sufficient to be heard in the ambient noise level likely to be encountered on board ships or in a survival craft.

**12.2.17** In the transmit condition, the output of the receiver shall be muted.

**12.2.18** The apparatus shall be so designed as to operate over the temperature range  $-20\text{ }^{\circ}\text{C}$  to

$+55\text{ }^{\circ}\text{C}$  and in storage throughout the temperature range  $-30\text{ }^{\circ}\text{C}$  to  $+70\text{ }^{\circ}\text{C}$ .

**12.2.19** The source of electrical power shall be integrated in the apparatus. A provision shall be made to replace the source of electrical power during operation of the apparatus. In addition, provision may be made to operate the apparatus using an external source of electrical power.

**12.2.20** Two-way VHF radiotelephone apparatus, in which the source of electrical power shall be replaced during operation, shall be provided with a dedicated primary battery for use in the event of a distress situation. This battery shall be equipped with a non-replaceable seal to indicate that it has not been used.

VHF apparatus, in which a replacement of the source of power is not needed during operation, shall be provided with a primary battery. VHF apparatus shall be fitted with a non-replaceable seal to indicate that it has not been used.

In close vicinity of each apparatus an auxiliary (emergency) set of primary batteries shall be provided.

Primary power supply batteries shall have the period of storage not less than 2 years and shall be replaced if on the date of survey of the shipboard radio equipment carried out by the Surveyor to the Register the period of their storage left is at least 12 months. The batteries shall be marked with the manufacture date and maximum storage period. Primary power supply batteries shall be of color or marking in compliance with 12.2.3.13.

Battery not intended for the use in the event of a distress situation shall be of colour or marking so that they can not be confused with batteries intended for such use.

**12.2.21** In addition to 5.1.47, the following shall be clearly indicated on the exterior of the apparatus:

- .1 brief operating instructions;
- .2 the ship's name and
- .3 expiry date for the primary batteries stored.

## 13 FLOAT-FREE RELEASE AND ACTIVATION ARRANGEMENTS FOR EMERGENCY RADIO EQUIPMENT

### 13.1 GENERAL

**13.1.1** Float-free release and activation arrangements enable the automatic release of emergency radio equipment from a sinking ship and its automatic activation.

**13.1.2** The arrangement shall:

**.1** be designed so that the release mechanism shall operate before reaching a depth of 4 m in any orientation of the ship;

**.2** be capable of operating throughout the temperature range of  $-30\text{ }^{\circ}\text{C}$  to  $+70\text{ }^{\circ}\text{C}$ ;

**.3** be constructed of non-corrosive compatible materials, so as to prevent any deterioration which may cause malfunction of the unit. Galvanizing or other forms of metallic coating on parts of the float-free release mechanism shall not be accepted;

**.4** be constructed to prevent release when seas wash over the unit;

**.5** not be unduly affected by seawater and oil or prolonged exposure to sunlight;

**.6** be capable of operating properly after exposure to shock, vibration and other severe environmental conditions encountered above deck on sea-going vessels;

**.7** if the ship navigates in areas where icing may be expected, be so designed as to minimize the formation of ice and prevent its effects from hindering the release of the radio equipment as far as practicable;

**.8** be mounted in such a way that the radio equipment, after being released, is not obstructed by the structure of the sinking ship;

**.9** carry a label indicating clearly the operating instructions for manual release.

**13.1.3** For radio equipment requiring external power or data connection, or both, the means of connection shall not inhibit the release or activation of the radio apparatus.

**13.1.4** It shall be possible to assess the proper functioning of the automatic release mechanism by a simple method without activation of the radio equipment.

**13.1.5** It shall be possible to release the radio equipment manually from the float-free mechanism.

**13.1.6** The float-free release and activation arrangements for emergency radio equipment shall be marked on the exterior with the manufacturer's name, date of manufacture, type and serial number, as well as the date of next checking or expiration of service life.

## APPENDIX

## INFORMATION FOR DETERMINATION OF AREAS OF NAVIGATION

Sea area A1 is that sea area which is within a circle of radius "A", in nautical miles, over which the radio propagation path lies substantially over the water surface. The radius "A" is equal to the transmission distance between a ship's VHF aerial at a height of 4 m and the aerial of the VHF coast station which lies at the centre of the circle.

The following formula shall be used to calculate the range "A":

$$A = 2,5(\sqrt{H} + \sqrt{h})$$

where  $H$  — the height of installing the coast station receiving aerial above sea level, m;

$h$  — the height of installing the ship's transmitting aerial above waterline which is assumed to be 4 m.

The formula applies to line-of-sight cases only. The range of sea areas A1 shall be plotted on navigational charts and verified by field strength measurements.

Sea area A2 is that sea area which is within a circle of radius "B", in nautical miles, over which the propagation path lies substantially over the water surface and which is not part of sea area A1.

The centre of the circle is the position of the coast station receiving aerial.

The range of sea areas A2 shall be plotted on navigational charts and verified by field strength measurements under the following conditions:

|  |                       |
|--|-----------------------|
| Frequency . . . . .                        | 2182 kHz              |
| Class of emission . . . . .                | J3E                   |
| Bandwidth . . . . .                        | 3 kHz                 |
| Propagation . . . . .                      | Groundwave            |
| Season . . . . .                           | Summer                |
| Peak power of ship's transmitter . . . . . | 60 W                  |
| Ship's aerial efficiency . . . . .         | 25%                   |
| S/N (RF) . . . . .                         | 9 dB (voice)          |
| Mean transmitter power. . . . .            | 8 dB below peak power |
| Fading margin . . . . .                    | 3 dB                  |

Sea area A3 is the area which is not part of any sea area A1 or A2 within which the elevation angle of an INMARSAT satellite is 5 degrees or more.

Sea area A4 is the sea area which is not part of any sea area A1, A2 or A3.

# PART V. NAVIGATIONAL EQUIPMENT

---

## 1 GENERAL

### 1.1 APPLICATION

**1.1.1** The requirements of the present Part of the Rules apply to ships constructed on or after 1 July 2002 whose navigational equipment is subject to survey by the Register, as well as to items of the above equipment intended for installation in these ships.

The requirements of the present Part of the Rules apply to ships of less than 150 gross tonnage engaged in any voyages, to ships of less than 500 gross tonnage not engaged in international voyages, and to fishing vessels unless the Administration whose flag the ship is flying has decided otherwise to fit these categories of ships with navigational equipment.

**1.1.2** Ships constructed before 1 July 2002 shall comply with the requirements of Part V of the Rules in force prior to 1 July 2002<sup>1</sup>, and the requirements of 1.1.3, 1.1.4, 1.1.5 of the present Part of the Rules.

**1.1.3**<sup>2</sup> Ships constructed before 1 July 2002 shall be fitted with a radionavigation system or systems receiver complying with the requirements of 5.12 and suitable for use at all times in the ship's service area to establish and update the ship's position by automatic means, not later than the first survey after 1 July 2002.

**1.1.4** All passenger ships irrespective of size and ships of 300 gross tonnage and upwards engaged in international voyages and constructed before 1 July 2002 shall be fitted with an automatic identification system (AIS), as follows:

in the case of passenger ships, not later than 1 July 2003;

in the case of tankers<sup>3</sup>, not later than first survey of equipment and outfit on or after 1 July 2003;

in the case of ships, other than passenger ships and tankers, of 50000 gross tonnage and upwards, not later than 1 July 2004;

in the case of ships, other than passenger ships and tankers, of 300 gross tonnage and upwards but less than 50000 gross tonnage, not later than first survey of equipment and outfit on or after 1 July 2004 or 31 December 2004, whichever is earlier.

All passenger ships irrespective of size and cargo ships, including tankers, of 500 gross tonnage and upwards not engaged in international voyages and constructed before 1 July 2002 shall be fitted with an

automatic identification system (AIS) not later than 1 July 2008.

**1.1.5** Passenger ships constructed before 1 July 2002 shall be fitted with a voyage data recorder as follows:

ro-ro passenger ships not later than the first survey on or after 1 July 2002;

passenger ships other than ro-ro passenger ships not later than 1 January 2004.

Cargo ships, including tankers, engaged in international voyages and constructed before 1 July 2002 shall be fitted with a simplified voyage data recorder (S-VDR) as follows:

ships of 20000 gross tonnage and upwards, during first planned docking after 1 July 2006, but not later than 1 July 2009;

ships of 3000 gross tonnage and upwards but less than 20000 gross tonnage, during first planned docking after 1 July 2007, but not later than 1 July 2010.

**1.1.6** Passenger ships, including high-speed passenger craft, irrespective of their size, and cargo ships, including high-speed craft, of 300 gross tonnage and upwards engaged in international voyages constructed on or after 31 December shall be fitted with a system of long range identification and tracking of ships (LRIT).

Passenger ships, including high-speed passenger craft, irrespective of their size, and cargo ships, including high-speed craft, of 300 gross tonnage and upwards engaged in international voyages constructed before 31 December and certified for operations in sea areas A1 and A2 or in sea areas A1, A2 A3 shall be fitted with a LRIT system not later than the first survey of the radio installation after 31 December 2008.

Passenger ships, including high-speed passenger craft, irrespective of their size, and cargo ships, including high-speed craft, of 300 gross tonnage and upwards engaged in international voyages constructed before 31 December and certified for operations in sea areas A1, A2, A3 and A4 shall be fitted with a LRIT system not later than the first survey of the radio installation after 1 July 2009. However, whilst these ships operate within sea areas A1, A2, A3 and A4, a LRIT system shall be fitted on them not later than the first survey of the radio installation after 31 December 2008.

Ships, irrespective of the date of construction, fitted with an automatic identification system (AIS), and operated exclusively within sea area A1, shall not be required to comply with the provision of this regulation.

---

<sup>1</sup>Rules for the Equipment of Sea-Going Ships, Edition 1999, pp. 211 to 264 (with regard to Notices No. 1 (2000) and No. 2 (2001)).

<sup>2</sup>Subject to compliance with the requirement of 1.1.3, a radio direction-finder is not required.

<sup>3</sup>The definition of a tanker is given in Part I "Classification" of Rules for the Classification and Construction of Sea-Going Ships.

**1.1.7** The present Part of the Rules specifies the requirements which navigational equipment shall comply with, as well as defines the compartments in which navigational equipment shall be located and the number of navigational instruments, appliances and devices and their arrangement aboard ship.

**1.1.8** The requirements of the present Part of the Rules also apply to ships under construction and in service irrespective of their dimensions, gross tonnage and date of construction whose equipment on the navigating bridge permits to ensure safe navigation by one man and for which distinguishing mark **OMBO** has been introduced in accordance with 2.2.7 of Part I "Classification" of Rules for the Classification and Construction of Sea-Going Ships.

## 1.2 DEFINITIONS AND EXPLANATIONS

**1.2.1** Terms, definitions and explanations in relation to the general terminology of the Rules are given in Part I "Classification" of the Rules for the Classification and Construction of Sea-Going Ships.

**1.2.2** The following definitions have been adopted for the purpose of the present Part of the Rules:

**Receiver autonomous integrity monitoring** — a method or an algorithm by means of which all the information acquired by the receiving part of the radio navigational system(s) is automatically processed to control the integrity of the navigation signals.

**Activation of an AIS target** — activation of a sleeping AIS target for the display of additional graphical and alphanumeric information.

**Activated AIS target** — a target representing the automatic or manual activation of a sleeping target for the display of additional graphically presented information.

**Almanac** — a set of parameters of the navigation system satellites on the orbit.

**Display base** means the level of SENC information which cannot be removed from the display, consisting of information which is required at all times in all geographic areas and all circumstances. It is not intended to be sufficient for safe navigation.

**Watch officer** is any person who is responsible for safe navigation, navigates, manoeuvres the ship and operates bridge equipment until he is relieved by another officer.

**Time of image reconstruction on the ECDIS display** means the time interval between moments of image reconstruction starting and new image generation completing.

**Time of image regeneration on the ECDIS display** means the time interval between

moments of operator's appropriate actions executing and subsequent reconstruction completing.

**Selected target** — a target selected manually for the display of detailed alphanumeric information in a separate data display area. The target is displayed by a "selected target" symbol.

**Main conning position** means a workstation or the navigating bridge providing the watch officer with a commanding view and equipped with everything necessary for ship's manoeuvring and control.

**Depth** means the vertical distance from a sea level to the bottom.

**Watch officer fitness** means an ability of any person keeping watch to perform his duties unassisted and to the full extent, and timely respond to all alarms/warnings and fitness verification signals as well.

**Display** is the electronic means presenting visual information in the letter, digital or graphical form.

$D_{ap}/T_{ap}$  — distance to the closest point of approach/time to the closest point of approach. Limits are set by the radar operator related to own ship

**Totally enclosed bridge** is a bridge without bridge wings, with the breadth of the wheelhouse equal to or exceeding the ship's breadth.

**Acquisition** is the selection of those targets requiring a tracking procedure and the initiation of their tracking.

**Acquisition of a radar target** — process of acquiring a target and initiating its tracking.

**Field of vision** is the horizontal angle within which no obstructions interfere in an observation of environment from a workstation on the navigating bridge.

**Suppressed area** — an area set by operator within which targets are not acquired.

**Acquisition/activation zone** — a zone set by operator in which the system should automatically acquire radar targets and activate AIS targets.

**Radiated interference** means interference radiated by the casings of equipment (apart from direct radiation of aerials).

**Depth contour** is a contour line connecting points of equal water depths on a chart.

**Route monitoring** means actions on navigation control along the pre-planned route.

**True speed** — Speed of a target relative to ground or to sea.

**True motion** — combination of true course and true speed.

**True course** — direction of motion relative to ground or to sea, of a target expressed as an angular displacement from north.

**True bearing** — direction of a target from own ship's reference location or from another target's

position expressed as an angular displacement from true north.

**Conducted interference** means interference from equipment at the electric power supply terminals.

**Standard magnetic compass** is a magnetic compass independent of any ship source of electrical power to determine the ship's heading and display the reading at the main steering position.

**Spare magnetic compass** is a stand-by magnetic compass to perform the function of the standard magnetic compass and interchangeable with it.

**Bridge wings** are those parts of the bridge on both sides of the ship's wheelhouse which, in general, extend to the ship's side.

**Heading** — direction in which the bow of a ship is pointing expressed as an angular displacement from north.

**Lookout** is one of basic duties of the watch officer carried out by sight and hearing as well as by all available equipment so as to make a full appraisal of the situation and of the risk of collision.

**Homing** is manoeuvring to steer the ship for the course, corresponding to the bearing for the given target, and keeping it to that course.

**Navigation** is the process of deciding, executing and maintaining course and speed of the ship in relation to waters and traffic while moving from one place to another.

**Tanker** for the purposes of the present Part, is an oil tanker, oil tanker (>60 °C), oil tanker (>55 °C), oil recovery vessel, oil recovery vessel (>60 °C), gas carrier<sup>1</sup>, chemical tanker<sup>1</sup>, combination carrier, whose definitions are given in Part I "Classification" of Rules for the Classification and Construction of Sea-Going Ships.

**Navigational equipment** means the ship facilities with which the ship is equipped for taking decisions on the navigational tasks.

**Navigational appliance** means the ship facility intended for taking decisions on one or more navigational tasks.

**Navigational instrument** means the ship's navigational device intended for manual operation while taking decisions on the navigational tasks.

**Navigational device** means a device intended to execute some functions on measuring navigational parameters as well as processing, storage, transmission, displaying and recording of the data while taking decisions on the navigational tasks on board the ship.

**Normal conditions (for OMBO ships)** means a situation when all systems and

equipment on the navigating bridge operate within design limits, and environmental conditions such as weather and traffic do not cause excessive workload to the officer of the watch.

**Data medium** is a means for data storage and reading using appropriate equipment.

**Generalized display** means overlapped reproducing on a display of information from several navigational devices or systems.

**Observation** means a determination of the ship's position by measuring several navigational parameters.

**OMBO** — a distinguishing mark for class notation, which means a control of a ship by one officer on a bridge.

**Dangerous target** — a target with a predicted CPA and TCPA that violates the values preset by the operator.

**Relative course** — direction of motion of a target relative to own ship's direction.

**Relative bearing** — direction of a target position from own ship's reference location expressed as an angular displacement from own ship's heading.

**Relative speed** — speed of a target relative to own ship's speed data.

**Displaying** means reproducing information from a navigational device, appliance or system on a display or other indicating device.

**Sleeping AIS target** — a target indicating the presence and orientation of a vessel equipped with AIS in a certain location. The target is displayed by a "sleeping target" symbol. No additional information is presented until activated.

**Target swap** — situation in which the incoming radar data for a tracked target becomes incorrectly associated with another tracked target or a non-tracked radar echo.

**Past positions** — equally time-spaced past position marks of a tracked radar target or activated AIS target and own ship. The past positions' track may be either relative or true.

**Consistent Common Reference Point** — a location on own ship, to which all horizontal measurements such as target range, bearing, relative course, relative speed, closest point of approach (CPA) or time to closest point of approach (TCPA) are referenced, typically the conning position of the bridge.

**Lost target** — a target representing the last valid position of a target before its data was lost. The target is displayed by a "lost target" symbol.

**Route planning** means actions performed while planning a route or making decisions on attendant navigational tasks.

**Trial manoeuvre** — facility used to assist the operator to perform a proposed manoeuvre for naviga-

<sup>1</sup> This definition is applicable in the case of carriage of flammable liquid cargo by the ships.



tion and collision avoidance purposes, by displaying the predicted future status of all tracked and AIS targets as a result of own ship's simulated manoeuvres.

**Desk** means a device combining control, monitoring, data displaying and communication facilities necessary to carry out one or several tasks at a particular workstation.

**Way point** means a point on the pre-set ship's track whose symbol and co-ordinates are entered in a control program.

**Operational display area** — area of the display used to graphically present chart and/or radar information, excluding the areas allocated to present other information.

**Workstation** means a position on the navigating bridge having the relevant equipment where the watch officer as well as the master or pilot carry out one or several tasks.

**Radar plotting** is the whole process of target detection, tracking, calculation of parameters and display of information.

**Radar target** — any object fixed or moving whose position and motion is determined by successive radar measurements of range and bearing.

**Raster chart display and information system (RCDIS)** means an operational mode of the electronic chart display and information system, which provides display of the raster navigational chart (RNC) and information on ships position from navigation sensors to assist the mariner in route planning and route monitoring, and, if required, display of additional navigation related information.

**Raster navigational chart (RNC)** means facsimile copy of a paper chart or chart folio prepared and distributed by authorized hydrographic office.

**Voyage data recorder (VDR)** means an appliance intended for collecting, recording and storage of voyage data and comprising: means for information encoding and recording, means for interfacing to data sensors, final recording medium placed in its capsule, ship's source of electrical power supply and built-in reserve power source.

**Back-up officer** means any person who is to be called if assistance is needed on the navigating bridge.

**Wheelhouse** is the endorsed area of the navigating bridge where the main conning position of the ship is located.

**Watch alarm** means an alarm that is transferred from the navigating bridge to the master and the back-up officer in case of the watch officer unfitness.

**Long range identification and tracking system (LRIT)** — a system that provides for the global identification and tracking of ships on the part of Contracting Governments.

**System raster navigational chart (SRNC)** means a database incorporating: RNC databases, updates and additional navigational information.

**System Electronic Navigational Chart (SENC)** — a database, in the manufacturer's internal ECDIS format, resulting from the lossless transformation of the entire ENC contents and its updates. It is this database that is accessed by ECDIS for the display generation and other navigational functions, and is equivalent to an up-to-date paper chart. The SENC may also contain information added by the mariner and information from other sources.

**Tracking** is the process of observing the sequential changes in the position of a target to establish the parameters of its motion.

**Means of data presentation** — display or another indicator which comprises an integral part of navigational equipment system and provides for presentation of the navigation-related information.

**Sea stabilization** — display mode in which speed and course information are referred to the sea, using gyro and water speed log input as reference.

**Ground stabilization** — display mode in which speed and course information are referred to the ground, using EPFS as reference.

**Standard display** — the level of information that should be shown when a chart is first displayed on ECDIS. The level of the information it provides for route planning or route monitoring may be modified by the mariner according to the mariner's needs.

**Ships constructed** — this definition is given in 1.2, Part IV "Radio Equipment" of these Rules.

**OMBO ship** means the one man bridge operated ship.

**Target's motion trend** is the indication on a display with permissible errors of a linear extrapolation into the future of a target's motion in a minute after tracking initiation.

**Simplified voyage data recorder (S-VDR)** means an appliance, including means for interfacing with the sources of input data, for processing and encoding the data, the final recording medium; the ship's power supply source and built-in reserve power source.

**Steady state tracking** — tracking a target, proceeding at steady motion:

after completing of the acquisition process, or without a manoeuvre of target or own ship, or without target swap or any disturbance.

**Transmitting heading device** is an electronic means to receive heading information from the sensor and to transmit it to other navigational equipment.

**Navigating bridge** means an area from which the navigation and control of the ship are exercised, including the wheelhouse and bridge wings.

**Integrity** — an ability of a radionavigational system to give a timely warning about the impossibility of using the system for the purpose of navigation.

**AIS target** — a target generated from an AIS message.

**Trunk for log and/or echo sounder** is a special watertight compartment in the ship's hull below waterline provided with a watertight closure.

**Navigator** is a specially trained person navigating and manoeuvring the ship using bridge equipment.

**Target's predicted motion** is the indication on a display of a liner extrapolation into the future of a target's motion based on measurements of the target's range and bearing in the recent past.

**Electronic chart display and information system (ECDIS)** means a system which with adequate backup arrangements can be accepted as complying with the uptodate chart, by displaying selected information from a system electronic navigational chart (SENC) with positional information from navigation sensors to assist the mariner in route planning and route monitoring, and, if required, display additional navigation related information.

**Electronic navigational chart (ENC)** means the database standardized as to content, structure and format, issued for use with ECDIS on the authority of government authorized hydrographic officer. The ENC contains all the chart information necessary for safe navigation and may contain additional navigational information.

### 1.3 SCOPE OF SURVEY

**1.3.1** General provisions regarding the procedure of survey of the navigational equipment are specified in General Regulations for the Classification and Other Activity.

**1.3.2** The following equipment is subject to supervision of the Register during its designing, manufacture, installation and operation:

- .1** standard, spare and lifeboat magnetic compasses;
- .2** transmitting heading devices;
- .3** gyrocompasses;
- .4** gyromagnetic compasses and gyroazimuths;
- .5** logs;
- .6** echo sounders;
- .7** rate-of-turn indicators;
- .8** radars;

- .9** automatic radar plotting aids (ARPA);
- .10** radiobeacon stations;
- .11** radionavigation system receivers;
- .12** combined ship control desks;
- .13** integrated navigation systems;
- .14** unified timing system;
- .15** electronic chart display and information systems (ECDIS);
- .16** ship's heading control systems;
- .17** ship's track control systems;
- .18** apparatus of automatic identification system;
- .19** outside sound signal reception systems;
- .20** voyage data recorders;
- .21** other, not listed above navigational appliances and devices, upon the Register requirement.

**1.3.3** Technical requirements for the navigational appliances and devices, their location and installation aboard the ship, which are not specified in the present Part of the Rules as well as the scope of survey of those appliances and devices are subject to special consideration by the Register in each case.

**1.3.4** The navigational devices and appliances indicated in items 19 to 27 of Table 2.2.1 are subject to survey by the Register only in the form of checking their availability on board ship.

**1.3.5** After installation on board ship, all navigational equipment shall be properly adjusted and subject to survey, tests in operation and electromagnetic compatibility tests.

After installation of new navigational equipment or renewal of outdated (which became inoperative and is not subject to repair) on ships in service the technical design of the installation and working drawings shall be submitted to the Register prior to commencement of survey of this equipment.

Upon approval of the technical design and working drawings the navigational equipment installed shall be surveyed on board ship and tested in operation.

On ships under construction tests of navigational equipment under operating conditions and electromagnetic compatibility tests of all radio and navigational equipment, fitted on the bridge or in the vicinity of the bridge, are conducted during mooring and sea trials in compliance with the programs approved by the Register.

**1.3.6** The approval of equipment developed without survey by the Register may be given after detailed consideration of technical documentation (description, diagrams, test records, etc.) and carrying out the appropriate tests in compliance with the requirements of the present Part of the Rules.

The scope of technical documentation for particular items of navigational equipment shall be not lower than that specified in 1.3.4, Part IV "Radio Equipment" of these Rules.

**1.3.7 Technical documentation for OMBO ships.**

**1.3.7.1** Before the beginning of the construction or conversion of a ship the following technical documentation shall be submitted to the Register for consideration:

**.1** deck plan of the navigating bridge indicating the arrangement of the relevant equipment.

The plans shall show the dimensions of the wheelhouse as well as the arrangement, sizes and angles of inclination of the windows and spacing between them, the bridge wings and entrances to the wheelhouse;

**.2** arrangement plan of consoles, front panels and their configuration with indication of all instruments and devices;

**.3** drawing of workstations with indication of the equipment located there.

The drawings shall show the blind zones as well as horizontal and vertical field of vision from the workstation. The vertical field of vision shall be shown for the ship in ballast;

**.4** arrangement plan of the equipment which is functionally connected with the navigating bridge but located outside its boundaries;

**.5** arrangement plan of aerials and radio equipment;

**.6** for computer-based systems the following shall be submitted:

description of computer system;

block diagram of the computer, indicating the interface with the transducers, controls, panel, display etc.;

accuracy of analog measurements;

description of self-checking system of the computer;

description of operation in emergency.

For computer-based systems the failure of which may affect the safe navigation and therefore they require redundancy, in addition to the above listed, the following documentation shall be submitted:

description of documenting procedures;

description of computer drawing;

description of procedures of allocation of responsibilities between different check stations;

description of test programme;

**.7** drawing of the navigating bridge communication system with accommodations and other spaces, and of a signalling system;

**.8** drawing of power supply to the whole equipment;

**.9** drawing of the system used for calling the officer of the watch;

**.10** specifications of the integrated navigation system;

**.11** drawing and specifications of signalling system of the watchman's alertness;

**.12** list of equipment. This list shall contain the information regarding the manufacturer, model type, its approval by the classification society as well as the safe distance from the magnetic compass.

**1.3.8** Every ship shall be permanently provided with the following technical documentation:

**.1** description and maintenance instructions for each kind of navigational equipment in Russian and in English;

**.2** circuit diagrams of the navigational equipment, corrected in accordance with all alterations made in the process of operation;

**.3** the document issued by a firm authorized by the Manufacturer or recognized by the Register confirming completion of the radar installation in full accordance with the Manufacturer's technical documentation and design approved by the Register. This document shall contain the following information:

about blind sectors and possible performance limitations;

about radar means of interface with other systems and about displacement of the consistent common reference point.

## 2 NAVIGATIONAL EQUIPMENT OF SELF-PROPELLED SEA-GOING SHIPS

### 2.1 DIVISION OF SHIPS INTO GROUPS

**2.1.1** For the purpose of the present Part of the Rules all self-propelled ships are grouped according to their gross tonnage (see Table 2.2.1).

**2.1.2** For the purpose of the present Part of the Rules special purpose ships are treated as passenger ships.

### 2.2 LIST OF NAVIGATIONAL EQUIPMENT

**2.2.1** Navigational devices, appliances and instruments which shall be installed on board ship or with which the ship shall be supplied shall be provided depending on the gross tonnage of the ship, area of navigation and ship's purpose in accordance with Table 2.2.1.

Table 2.2.1

| Nos | Navigational equipment   | Number of items for ships of gross tonnage |                    |                    |       |                |                |                | Remarks  |
|-----|--|--|--------------------|--------------------|-------|----------------|----------------|----------------|--|
|     |  | < 150                                      | ≥ 150 <sup>1</sup> | ≥ 300 <sup>1</sup> | ≥ 500 | ≥ 3000         | ≥ 10000        | ≥ 50000        |  |
| 1   | Standard magnetic compass <sup>2</sup>   | 1  | 1                  | 1                  | 1     | 1              | 1              | 1              | The compass shall be complete with a pelorus or bearing device independent of any power supply to take bearings over an arc of the horizon of 360°         |
| 2   | Spare magnetic compass   | —  | 1                  | 1                  | 1     | 1              | 1              | 1              | Shall be interchangeable with the standard magnetic compass.<br>Not required where complete doubling of standard magnetic compass is provided (See Note 6) |
| 3   | Radionavigation system/systems receiver <sup>3</sup>                             | 1  | 1                  | 1                  | 1     | 1              | 1              | 1              | The ship's position shall be established by automatic means  |
| 4   | Radar <sup>4</sup> with  | —  | —                  | 1                  | 1     | 2              | 2              | 2              | One radar shall be a 9 GHz radar (wave length of 3 cm)   |
|     | .1 electronic plotting aid (EPA)   | —  | —                  | 1                  | —     | —              | —              | —              | —  |
|     | .2 automatic tracking aid (ATA)  | —  | —                  | —                  | 1     | 2              | 1              | 1              | —  |
|     | .3 automatic radar plotting aid (ARPA)   | —  | —                  | —                  | —     | —              | 1              | 1              | —  |
| 5   | Simplified voyage data recorder (S-VDR)  | —  | —                  | —                  | —     | 1 <sup>6</sup> | 1 <sup>6</sup> | 1 <sup>6</sup> | —  |
| 6   | Transmitting heading device <sup>7</sup>   | —  | —                  | 1 <sup>5</sup>     | —     | —              | —              | —              | —  |
| 7   | Gyrocompass <sup>8</sup>   | —  | —                  | —                  | 1     | 1              | 1              | 1              | The gyrocompass shall be complete with a repeater (repeaters) to take bearings over an arc of horizon of 360° <sup>9</sup>                                 |
| 8   | Echo sounder   | —  | —                  | 1                  | 1     | 1              | 1              | 1              | —  |
| 9   | Speed and distance measuring device through the water (log)                      | —  | —                  | 1                  | 1     | 1              | 1              | 1              | Shall measure speed and the distance run through the water   |
| 10  | Speed and distance measuring device over the ground (absolute log) <sup>10</sup> | —  | —                  | —                  | —     | —              | —              | 1              | Shall measure speed and the distance run over the ground   |
| 11  | Automatic identifications system (AIS)   | —  | —                  | 1 <sup>11</sup>    | 1     | 1              | 1              | 1              | —  |
| 12  | Heading or track control system  | —  | —                  | —                  | —     | —              | 1              | 1              | —  |
| 13  | Rate of turn indicator   | —  | —                  | —                  | —     | —              | —              | 1              | —  |
| 14  | Sound reception system   | 1  | 1                  | 1                  | 1     | 1              | 1              | 1              | Required in ships with totally enclosed navigating bridge and <b>OMBO</b> ships  |
| 15  | Voyage data recorder (VDR) <sup>12</sup>   | —  | —                  | —                  | —     | 1              | 1              | 1              | Not required on ships not engaged in international voyages   |
| 16  | Electronic chart display and information system (ECDIS) <sup>13</sup>            | —  | 1                  | 1                  | 1     | 1              | 1              | 1              | Back-up arrangements shall be provided in accordance with 5.15.55  |
| 17  | Indicators of:   |  |                    |                    |       |                |                |                | The indicators shall be readable from the conning position   |
|     | .1 rudder angle  | —  | —                  | —                  | 1     | 1              | 1              | 1              | —  |
|     | .2 propeller revolutions, the force and direction of thrust                      | —  | —                  | —                  | 1     | 1              | 1              | 1              | —  |
|     | .3 pitch and operational mode of controllable pitch propeller(s) <sup>14</sup>   | —  | —                  | —                  | 1     | 1              | 1              | 1              | —  |
|     | .4 force and direction of lateral thrust of the thruster(s) <sup>15</sup>        | —  | —                  | —                  | 1     | 1              | 1              | 1              | —  |
| 18  | Radar reflector <sup>16</sup>  | 1 <sup>17</sup>                            | —                  | —                  | —     | —              | —              | —              | —  |
| 19  | Hand lead, set   | 1  | 1                  | 1                  | 1     | 1              | 1              | 1              | —  |
| 20  | Navigational sextant   | —  | —                  | 1                  | 1     | 1              | 1              | 2              | —  |
| 21  | Marine chronometer   | —  | —                  | 1                  | 1     | 1              | 1              | 1              | Two chronometers are required in passenger ships and special purpose ships of more than 300 gross tonnage  |
| 22  | Stopwatch  | —  | 1                  | 1                  | 2     | 3              | 3              | 3              | —  |

| Nos | Navigational equipment                  | Number of items for ships of gross tonnage |                    |                    |       |        |         |         | Remarks  |
|-----|---|--|--------------------|--------------------|-------|--------|---------|---------|--|
|     |   | < 150                                      | ≥ 150 <sup>1</sup> | ≥ 300 <sup>1</sup> | ≥ 500 | ≥ 3000 | ≥ 10000 | ≥ 50000 |  |
| 23  | Star globe or any equivalent instrument | —  | —                  | —                  | 1     | 1      | 1       | 1       | Not required in ships of restricted areas of navigation <b>R2, R2-RSN, R3, R3-RSN</b><br>—<br>Not required in ships of restricted area of navigation <b>R3</b><br>—<br>— |
| 24  | Prismatic binocular                     | 1  | 1                  | 1                  | 2     | 3      | 4       | 4       |  |
| 25  | Anemometer                              | —  | —                  | 1                  | 2     | 2      | 2       | 2       |  |
| 26  | Aneroid barometer                       | —  | 1                  | 2                  | 2     | 2      | 2       | 2       |  |
| 27  | Inclinometer                            | 1  | 1                  | 1                  | 2     | 2      | 2       | 2       |  |

<sup>1</sup> Including passenger ships irrespective of size.  
<sup>2</sup> Remote transmission of the standard magnetic compass dial readings to the principal steering position is required.  
<sup>3</sup> The radionavigation system used (global navigation satellite system or terrestrial radionavigation system) shall be available for use at all times throughout the intended voyage.  
<sup>4</sup> Where two radars are required, they shall operate independently of one another.  
<sup>5</sup> Provision shall be made for transmitting heading information for input to the equipment referred to in items 4, 4.1, 11 of the Table.  
<sup>6</sup> Not required on ships constructed on or after 1 July 2002 (refer to 1.1.5 of this Part).  
<sup>7</sup> Not required provided the ship is fitted with a gyrocompass to transmit heading information for input to the equipment referred to in items 4, 4.1, 11 of the Table.  
<sup>8</sup> Provision shall be made for transmitting heading information for input to the equipment referred to in items 4, 4.2, 4.3, 11 of the Table, and for supplying heading information visually at the emergency steering position. The heading information shall be supplied visually at the emergency steering position by a gyrocompass repeater.  
<sup>9</sup> Required in ships of less than 1600 gross tonnage as far as practicable.  
<sup>10</sup> Speed and distance over the ground shall be measured in the forward and athwartship direction.  
<sup>11</sup> Not required in cargo ships not engaged in international voyages.  
<sup>12</sup> Passenger ships irrespective of size shall be fitted with a voyage data recorder.  
<sup>13</sup> Not required provided corrected paper nautical charts are available on board for route planning and route monitoring throughout the intended voyage.  
<sup>14</sup> To be fitted where controllable pitch propeller(s) is/are provided.  
<sup>15</sup> To be fitted where thruster(s) is/are provided.  
<sup>16</sup> Not required where the ship's effective echoing area is sufficient to enable detection by radar at 9 GHz and 3 GHz (corresponding to a wave length of 3 and 10 cm, respectively).  
<sup>17</sup> The provisions for the equipment are set out in Part III "Signal Means".

**Notes:**  
1. Non-self-propelled ships intended for being towed and pushed at sea, as well as for long period anchorage outside the port aquatorium or the roadstead and having people on board shall be provided with binoculars, hand lead and inclinometer.  
2. The ships of river-sea navigation (marks for restricted areas of navigation in the character of classification of a ship are **R2-RSN** and **R3-RSN**) engaged on inland waterways voyages shall be fitted with the additional radar meeting the requirements in 5.7.31. The additional radar is not required in case the radar ultimately complying with the requirements of 5.7 is installed on board such ships.  
3. In ships under 3000 gross tonnage the second radar with an effective display diameter not less than that required by 5.7.10 may be installed.  
4. In ships fitted with a radar with a plotting aid (EPA, ATA or ARPA) and/or a track control system, a speed and distance measuring device through the water (log) shall be provided.  
5. In ships of 500 gross tonnage and upwards but less than 10000 constructed before 1 September 1984 no log is required, provided it has not been fitted according to the ship design during construction of the ship.  
6. On ships contracted for construction on or after 1 January 2007, gyrocompass which shall be supplied from the main and emergency source of electrical power as well as from the transitional source of power which may be an accumulator battery may be used as a spare magnetic compass. In this case such gyrocompass cannot be considered as required by item 7 of the present Table for ships of 500 gross tonnage and more

The definitions of the areas of navigation are given in 1.2, Part I "Survey Regulations".

**2.2.2** In addition to the requirement of 2.2.1, it is recommended that ships shall be fitted with:

- .1** a unified timing system;
- .2** an integrated navigational system (in the case of ships of more than 10000 gross tonnage);
- .3** rate-of-turn indicator (in the case of ships with the navigating bridge located forward as ships provided with an integrated navigational system);
- .4** radiobeacon station (in the case of ships with helicopter equipment);
- .5** electronic chart display and information system (ECDIS).

**2.2.3** Navigational equipment required for ships of special design which is not stipulated for separate types of ships by the Rules is, in each case, subject to special consideration by the Register.

**2.2.4** Navigational equipment as required in Table 2.2.1 may be replaced by any recently invented, designed or modified equipment, provided it is equivalent in respect of its application, has the required or better operational and technical characteristics and is approved by the Register.

**2.2.5** Navigational equipment in excess of that required by the present Part of the Rules may be installed on board ship as additional equipment, provided its arrangement and operation do not

interfere with the normal use of required navigational devices and instruments, influence the readings thereof and diminish safety of navigation.

The navigational equipment fitted on board ship additionally to the mandatory equipment specified in Table 2.2.1 shall be of the type approved by the Register and meet the performance requirements imposed upon the mandatory equipment.

**2.2.6** Where a speed and distance measuring device over the ground (absolute log) is fitted in a ship, it shall comply with the requirements of 5.4.

### 2.3 SOURCES OF POWER

**2.3.1** All navigational equipment installed on board ship shall be provided with power supply from the main and emergency sources of electrical power.

**2.3.2** The switchboard of navigational equipment shall be supplied from the main and emergency switchboards by two independent feeders (see Part XI

"Electrical Equipment" of Rules for the Classification and Construction of Sea-Going Ships).

**2.3.3** Power supply for the ship navigational equipment shall be provided in accordance with the requirements in Table 2.3.3.

It is recommended to provide a continuous power supply device on board to ensure operational integrity of navigational equipment and safety of navigational information in case the main and emergency sources of electrical power are out of order or for the time required to change over from the main source of electrical power to the emergency source or vice versa. In this case, audible alarm and visual indication shall be provided at the position from which the ship is normally navigated to indicate the change-over to the source of continuous power supply. It shall not be possible to disable this alarm and indication. Both the alarm condition and indication shall reset automatically when the ship's supply has been restored. Provision shall be made for the manual acknowledgement of audible alarm.

Table 2.3.3

| Nos | Navigational equipment                                  | Source of energy   | Minimum number of hours of continuous operation of equipment used for calculating the capacity of accumulator batteries |
|-----|---|--|---|
| 1   | Magnetic compass (standard and spare)                   | Ship's mains and emergency source of electrical power (power supply from emergency source of electrical power may be substituted by that from accumulator batteries)   | 6   |
| 2   | Gyrocompass   | Ship's mains and emergency source of electrical power  | —   |
| 3   | Log   | Ship's mains and emergency source of electrical power  | —   |
| 4   | Rate-of-turn indicator                                  | Ship's mains and emergency source of electrical power  | —   |
| 5   | Echo sounder  | Ship's mains and emergency source of electrical power  | —   |
| 6   | Radar   | Ship's mains and emergency source of electrical power  | —   |
| 7   | Automatic radar plotting aids                           | Ship's mains and emergency source of electrical power  | —   |
| 8   | Radionavigation system receivers <sup>1</sup>           | Ship's mains and accumulator batteries (power supply from accumulator batteries may be substituted by that from the emergency source of electrical power) <sup>1</sup> | 1   |
| 9   | Unified timing system                                   | Ship's mains   | —   |
| 10  | Radiobeacon station                                     | Ship's mains and accumulator batteries (power supply from accumulator batteries may be substituted by that from the emergency source of electrical power)              | 6   |
| 11  | Electronic chart display and information system         | Ship's main and emergency source of electrical power   | —   |
| 12  | Back-up electronic chart display and information system | Ship mains and emergency source of electrical power  | —   |
| 13  | Sound reception system                                  | Ship's mains and emergency source of electrical power  | —   |
| 14  | Voyage data registrar, simplified voyage data recorder  | Ship's mains, emergency source of electrical power and accumulator batteries (integrated) <sup>2</sup>   | 2   |
| 15  | Apparatus of the ship automatic identification system   | Ship's mains and emergency source of electrical power  | — <sup>3</sup>  |
| 16  | Heading control system                                  | Ship's mains   | —   |
| 17  | Ship's track control system                             | Ship's main  | —   |
| 18  | Transmitting heading device                             | Ship's mains and emergency source of electrical power  | —   |

<sup>1</sup> Radio navigation system receivers used for automatic input into GMDSS radio installations of data concerning ship's position and time when it was fixed shall be also supplied from the reserve source of electrical power required by 2.3.3, Part IV "Radio Equipment".

<sup>2</sup> In VDR/S-VDR provision shall be made for an automatic charging device to maintain the accumulator batteries in charged condition and to enable recharging of the completely discharged batteries during 10 hours after the power supply of the VDR from the ship's power source has been restored.

<sup>3</sup> Where on ships constructed before 1 July 2002 an accumulator battery is an emergency source of electrical power, the capacity of this battery shall be sufficient to provide operation during at least one hour.

**2.3.4** All electrically operated navigational devices and instruments (except gyrocompasses and heading or track control systems) shall be supplied by separate feeders from one common switchboard of navigational equipment.

The gyrocompass shall be powered in accordance with 3.7.2.3.

Heading control system and track control system shall be supplied under 5.5.12, Part XI "Electrical Equipment" of Rules for the Classification and Construction of Sea-Going Ships.

**2.3.5** Where any kinds of navigational equipment are designed for being fed from various primary currents or various primary voltages, such equipment is exceptionally allowed to be fed from other switchboards, provided they are located close to the principal switchboard of the navigational equipment.

**2.3.6** If any kinds of navigational equipment are fed from additional switchboards, such switchboards shall get the supply from the corresponding sources of power through separate feeders.

**2.3.7** The switchboard (switchboards) of navigational equipment shall be provided with switches and fuses or with circuit-breakers. These devices shall be fitted in circuits leading to each kind of navigational equipment.

Connecting of consumers not associated with navigational equipment to the navigational equipment switchboard is not allowed.

**2.3.8** Every accumulator battery, the use of which is allowed for supply of several consumers, shall have a capacity required in Table 2.3.3 which is sufficient for continuous and simultaneous operation of all consumers connected to it without recharging.

**2.3.9** For **OMBO** ships:

**.1** the radio and navigational equipment shall be supplied from the ship's mains in compliance with the requirements of Part XI "Electrical Equipment" of Rules for the Classification and Construction of Sea-Going Ships;

**.2** the switchboards of radio and navigational equipment shall be supplied from the main and emergency switchboards by two independent feeders equipped with automatic switch in case of stopping the power supply from the main switchboard. In this case, audible and visual alarms shall be operated;

**.3** where computerized equipment are interconnected through a computer network, failure of this network shall not prevent individual equipment from performing their functions;

**.4** bridge navigational watch alarm system (BNWAS) shall be supplied from the navigational equipment switchboard. The means indicating the lack of supply, faults, as well as the means for prompt sounding the second and third stage alarm for the urgent call of the back-up officer and/or ship's master shall be supplied from an accumulator battery for at least during 1 h.

## 2.4 AERIALS

**2.4.1** In every ship there shall be erected some types of aerials which provide operation of the following navigational equipment:

**.1** radar;

**.2** radionavigation system receivers;

**.3** radiobeacon station (the use of aerial of radiobeacon station for radio communication facilities is subject to special consideration by the Register).

**.4** ship automatic identification system (AIS).

## 2.5 SPARE PARTS AND SUPPLY

**2.5.1** Every ship of more than 500 gross tonnage and passenger ship of more than 300 gross tonnage shall be supplied with minimum amount of spare parts, portable measuring instruments, tools and materials assigned for normal operation of navigational equipment installed in these ships.

**2.5.2** Complete sets of spare parts, portable measuring instruments, tools and materials are subject to special consideration by the Register.

## 2.6 MAINTENANCE OF AND REPAIRS TO NAVIGATIONAL EQUIPMENT

**2.6.1** Maintenance of and repairs to the shipborne navigational equipment shall be provided to ensure its working ability.

**2.6.2** The manner of navigational equipment technical servicing and of making repairs to it should be chosen by the Shipowner and agreed with the Register.

**2.6.3** The firms providing technical servicing and repairs to the navigational equipment shall be recognized by the Register for performing such tasks.

### 3 SPACES INTENDED FOR INSTALLATION OF NAVIGATIONAL EQUIPMENT. ARRANGEMENT OF NAVIGATIONAL EQUIPMENT AND CABLING

#### 3.1 GENERAL

**3.1.1** Every ship to be fitted with the navigational equipment shall be provided with the following spaces:

**.1** wheelhouse and chartroom (combined or separated);

**.2** generator room and/or operating room, i.e. special room intended for installation of navigational equipment;

**.3** accumulator battery room;

**.4** compartment for installation of master gyro-compass (unless provision is made for installing the master gyrocompass in the wheelhouse);

**.5** trunk for log and/or echo sounder.

**3.1.2** All spaces intended for installation of the navigational equipment shall be provided with electrical lighting, heating (with the exception of trunk for log and/or echo sounder) and the plug sockets shall be fitted therein.

**3.1.3** Navigational devices, appliances, cables and other equipment fitted on the navigating bridge shall be so arranged that the magnetic fields produced by such equipment shall not distort the magnetic compass readings by more than  $\pm 0,5^\circ$ .

#### 3.2 NAVIGATING BRIDGE<sup>1</sup>

**3.2.1** Design of the navigating bridge and arrangement of the equipment thereon shall be such as to ensure the possibility of effective steering of the ship and to comply with the applicable requirements of the Appendix to this Part.

**3.2.2** The navigating bridge shall be located above all deck constructions which are at the level or higher of the freeboard deck with exception of smoke funnels.

**3.2.3** The view of the sea surface from the conning position shall not be obscured by more than two ship's lengths or 500 m, whichever is less, forward of the bow to  $10^\circ$  on either side under all conditions of draught, trim and deck cargo.

<sup>1</sup>The requirements of 3.2.3 to 3.2.14 are applicable to ships with overall length 55 m and more constructed on 1 July 1998 or after this date. The requirements of 3.2.3 to 3.2.14 are applicable as far as practicable and expedient to ships with overall length less than 55 m. Ships of unconventional design, which on the opinion of the flag state Administration cannot meet the requirements of 3.2.3 to 3.2.14 shall be provided with measures and arrangements to achieve a level of visibility from the bridge that is as near as practical to those requirements.

The maximum and minimum values of the forward and aft draught at which the present visibility requirement fails to be fulfilled shall be entered in the Stability Information in accordance with 3.4.1.6.4 of Appendix 1 to Part IV "Stability" of the Rules for the Classification and Construction of Sea-Going Ships.

**3.2.4** Blind sectors, caused by cargo, cargo gear or other obstructions outside of the wheelhouse which obstruct the view of the sea surface ahead of the ship as seen from the conning position shall not exceed  $10^\circ$  each. The total blind sector of the obstructed view shall not exceed  $20^\circ$ . The clear sectors between blind sectors shall be at least  $5^\circ$ . However, in the view described in 3.2.3, each individual sector shall not exceed  $5^\circ$ .

**3.2.5** The lower edge of the navigating bridge front windows shall be as low as possible for not to obstruct to the forward view.

The height of the desks arranged immediately adjacent to the fore bulkhead of wheelhouse shall not exceed 1300 mm.

**3.2.6** The upper edge of the navigating bridge front windows shall be at a height not less than 2000 mm above the deck surface to provide a forward view from the conning position for a person with a height of eye of 1800 mm, when the ship is pitching up to  $10^\circ$ .

In ships where the forward view in the centre-line is obstructed by masts, cranes and other deck structures, two additional positions giving a clear view ahead shall be provided, one on the port side and one on the starboard side of the centre-line, no more than 5 m apart.

**3.2.7** The horizontal field of vision from the conning position shall be provided over an arc of at least  $225^\circ$ , that is from right ahead to not less than  $22,5^\circ$  abaft the beam on either side of the ship.

**3.2.8** From each bridge wing the horizontal field of vision shall be provided over an arc of not less than  $225^\circ$ , that is from at least  $45^\circ$  on the opposite bow through right ahead and then from right ahead to right astern through  $180^\circ$  on the same side of the ship.

**3.2.9** From the main steering position the horizontal field of vision shall be provided over an arc from right ahead to at least  $60^\circ$  on each side of the ship.

**3.2.10** The ship's side shall be visible from the bridge wing.

The use of a remote camera system may be accepted for ships of unconventional design as means for achieving the view of the ship's side from the



bridge wing, provided the above system meets the following requirements.

**3.2.10.1** The installed remote camera system shall be redundant from the circuit breaker to the camera and screen, including communication cables, i.e. the system shall provide on each side of the ship redundancy of:

.1 power cables and automatic circuit breakers from the main switchboard to the camera and the screen;

.2 camera;

.3 screen;

.4 transmission lines from the camera to the display screen;

.5 components associated with these lines and cables.

**3.2.10.2** The remote camera system is powered from the ship's main source of electrical power and is not required to be powered by the emergency source of electrical power.

**3.2.10.3** The remote camera system is capable of continuous operation under environmental conditions as per 5.1 of the present Part.

**3.2.10.4** The view provided by the remote camera system is regarded sufficient for the purpose and is also displayed at locations where the manoeuvring of the ship may take place.

**3.2.10.5** The upper edge of the ship's side abeam shall be viewed visually from all locations where the manoeuvring of the ship may take place.

The solution on the permissibility of the use of remote camera system is accepted by the flag state Administration (national authority).

**3.2.11** Number of framings between navigation bridge windows shall be minimum and they shall not be installed immediately forward of workstation of watch officer assistant and helmsman.

**3.2.12** For avoiding reflections the bridge front windows shall be inclined from the vertical plane top out, at an angle of not less than 10° and not more than 25°.

It is recommended that bridge rear and side windows should be inclined in a similar manner (with the exception of doors).

**3.2.13** Polarized and tinted glass for windows shall not be fitted.

To ensure a clear view in bright sunshine, it is recommended that removable sunscreens with minimum colour distortion should be provided.

**3.2.14** At all times regardless of weather condition, at least two of the navigating bridge front windows shall provide a clear view and depending on the bridge configuration, an additional number of windows shall be fitted with means of effective cleaning, anti-icing and anti-fogging devices.

**3.2.15** The arrangement of navigational equipment in the wheelhouse and their design shall provide the possibility to effect steering of the ship

under all operating conditions including emergency conditions.

**3.2.16** Some navigational devices, instruments and ship manoeuvring control desks may be installed on bridge wings.

**3.2.17** Provision shall be made for free passage of not less than 1200 mm in width from one bridge wing to the other.

**3.2.18** The distance from the fore bulkhead of the wheelhouse to any control desk or device (instrument) located on the navigating bridge shall be not less than 800 mm. The distance between two desks shall be not less than 700 mm.

The combined ship control desk may be installed close to the fore bulkhead of the wheelhouse.

With any of the above arrangements of the desk provision shall be made for observation of the environmental conditions through the windows of the wheelhouse.

The departure from the above requirements for ships of less than 1600 gross tonnage is subject to special consideration by the Register in each case.

**3.2.19** The height from the deck plating to the top ceiling in the wheelhouse shall be not less than 2250 mm.

The distance between the deck plating of the navigating bridge and the lower edge of the equipment located on the top ceiling above passages, open places, stations is to be not less than 2100 mm.

**3.2.20** All navigational information shall be presented to the operator in the interpreted and processed form so that he could save time for taking measures.

It is recommended that the integrated electronic indicators of navigational information be used.

**3.2.21** Navigational devices and instruments used for direct steering control of the ship or connected with the controls shall be such that displayed data could be read at a distance not less than 1000 mm under all operating conditions.

All other devices and instruments located on the navigating bridge shall be such that their indications could be read at a distance not less than 2000 mm under normal lighting.

**3.2.22 General requirements to the OMBO ship's navigating bridge.**

**3.2.22.1** The bridge configuration, the arrangement of consoles and equipment location shall enable the watch officer to perform its duties from one or several workstations.

**3.2.22.2** The main conning position of the ship shall be arranged in a way to enable the ship's control and manoeuvring, and a proper lookout by one person under normal operating conditions.

All relevant instrumentation and controls shall be easily visible, audible and accessible from the watch officer workstation.

**3.2.22.3** The field of vision from the ship's main conning position shall be such as to enable observation of all objects which may influence the ship's safety.

The main workstation on the navigating bridge shall have the field of vision according to the requirements in 3.2.3, 3.2.4, 3.2.7 and 3.2.9.

**3.2.22.4** To perform one or several auxiliary functions, other workstations may be arranged on the navigating bridge. The field of vision from these workstations shall also comply with the foregoing.

**3.2.22.5** The bridge layout design and workstations shall provide the coordinated performance of two people if needed under operational conditions.

**3.2.22.6** External sound signals, that are audible on the open deck, shall also be audible inside the wheelhouse. For this purpose, the sound reception system complying with the requirements of 5.19 shall be installed aboard.

**3.2.22.7** The navigating bridge and its equipment design shall comply with the requirements providing the watch officer with a safe performance of its duties related to the ship's control. For this purpose:

**.1** instruments and equipment shall not have sharp edges, corners and protuberances;

**.2** hand-rails shall be fitted inside of the wheelhouse and around consoles;

**.3** the deck in the wheelhouse shall have anti-slip coating;

**.4** doors to the bridge wings shall be easy to open, close and secure at the opened and closed positions;

**.5** chairs at the navigating bridge workstations shall be movable, adjusted by height and secured on a deck at the set place.

**3.2.23 OMBO ship's navigating bridge equipment.**

**3.2.23.1** The instrumentation and controls at the ship's main conning position shall be arranged to enable the watch navigator to:

**.1** determine and plot the ship's position, course and speed;

**.2** analyse the traffic situation in the water area;

**.3** decide on collision avoidance manoeuvres;

**.4** alter course;

**.5** change speed;

**.6** effect internal and external communications related to manoeuvring including communication on the VHF;

**.7** give sound signals;

**.8** hear sound signals being in the wheelhouse;

**.9** monitor course, speed, track, propeller revolutions (pitch), rudder angle and depth of water;

**.10** timely record voyage data.

**3.2.23.2** The following equipment shall be installed on the navigating bridge of OMBO ships. The technical parameters of this equipment shall comply with the requirements given in the appropriate sections of the present part of the Rules:

**.1** automatic radar plotting aid (ARPA) which shall give warning on emergence of a dangerous target with a lead of 6 to 30 min depending on the permissible time of closing to a minimum distance;

**.2** ship's heading and/or track control system giving alarm when the ship deviates from the pre-set course or track for a value exceeding the limits. An alarm shall be given by a device which is independent from a control system;

**.3** pre-warning system to give a signal at the approach of the next waypoint (when following the planned track);

**.4** alarm system to give a signal when approaching dangerous soundings (the water depth beneath the ship is less than a predetermined value) or boundaries of a zone prohibited for ship's navigation;

**.5** two independent electronic position fixing systems capable of a passing determination in data processed and of a warning alarm generation in case of a malfunction or failure of either system;

**.6** electronic chart display and information system (ECDIS);

**.7** voyage data recorder;

**.8** automatic identification system;

**.9** two independent radars; one of them shall operate within 3 cm range;

**.10** magnetic compass;

**.11** gyrocompass (repeater);

**.12** log (repeater);

**.13** echo sounder;

**.14** propulsion plant remote control system;

**.15** whistle control device;

**.16** window wipe and wash control device;

**.17** main workstation console lighting control device;

**.18** steering gear pump selector/control switches;

**.19** internal communication system;

**.20** radio equipment in accordance with 2.2, Part IV "Radio Equipment";

**.21** wheelhouse heating/cooling control system.

**3.2.23.3** The alarm/warning and communication system (AWCS) shall be provided on the navigating bridge which generates audible and visual alarms in the following cases:

**.1** the ship's approach to the pre-set minimum depth under a keel;

**.2** detection of a dangerous target;

**.3** deviation from a pre-set course and/or track;

**.4** an approach to the next waypoint (when following a pre-set track);

**.5** a gyrocompass malfunction;

**.6** a sharp drop below a permissible level or failure of power supply for navigational equipment;

**.7** a malfunction of a system verifying watch officer fitness;

**.8** failure of navigation lights.

Devices to acknowledge AWCS signals shall be provided at all workstations on the navigating bridge. Any alarm/warning shall be automatically transferred to the master and, if he deems it necessary, to the back-up officer and to the public rooms, if not acknowledged on the bridge by the watch officer within 30 s. The alarm/warning transfer shall be operated through a fixed system. Acknowledge of alarms/warnings shall only be possible from the bridge.

Under all operational conditions a watch officer shall have a possibility to call the master and back-up officer to the bridge. A bridge call signal given by a watch officer shall be clearly audible in the cabins of the master, back-up officer and all public spaces of the ship. If the back-up officer may attend a location not connected to the fixed communication system, he shall be provided with a wireless portable device enabling both the alarm/warning transfer and the two way speech communication with the watch officer on the navigating bridge.

In case of loss of main source power supply for an alarm transfer system an automatic changeover to an emergency source shall be provided.

**3.2.23.4** The **OMBO** ship's navigating bridge shall have priority in the service telephone communication system.

**3.2.23.5** The bridge navigational watch alarm system (BNWAS) shall be provided on the navigating bridge of the **OMBO** ship which shall not affect the watch officer's duties performed.

The system shall be capable of setting a time period for fitness verification within 3 to 12 min, and arranged so that only the ship's master had access to the system components for setting appropriate intervals, and also shall have protection against an unauthorized intervention.

The system shall provide for the acknowledgement of a check signal at any workstation on the navigating bridge.

Any attempt to switch off a fitness verification system shall be recorded and if the system and its supply fail the relevant alarm shall be given through the AWCS.

If an integrated navigation system is fitted aboard the ship, the watch officer fitness may be verified with a special program which shall not cause an additional workload for a watch officer.

### 3.3 GENERATOR ROOM

**3.3.1** The generator room which is intended for installation of converters used for the navigational equipment shall be located in close proximity to the wheelhouse or the operating room if the latter is available in a ship.

However, the generator room shall be so located that the acoustic noise caused by operating generators shall not be heard on the navigating bridge.

**3.3.2** The generator room shall be provided with heating, ventilation and electric lighting as to ensure effective operation of the equipment installed therein. Steam and hot-water heating is not allowed. The deck of the generator room shall be covered with linoleum or any other durable electric insulating material.

**3.3.3** Rotary converters and various electrical devices shall be installed in the generator room in compliance with the requirements stated in Part XI "Electrical Equipment" of Rules for the Classification and Construction of Sea-Going Ships.

### 3.4 ACCUMULATOR BATTERY ROOM

**3.4.1** The accumulator batteries feeding the navigational equipment may be installed in the accumulator battery room of the radio communication facilities provided that they cause no radio interference during radio reception.

**3.4.2** If a ship is equipped with the accumulator battery room which is intended solely for the navigational equipment, it shall comply with the requirements specified in 3.3, Part IV "Radio Equipment".

**3.4.3** It is permitted to place accumulator batteries in special boxes complying with requirements of 3.3.6, Part IV "Radio Equipment".

### 3.5 COMPARTMENT INTENDED FOR INSTALLATION OF MASTER GYROCOMPASS

**3.5.1** The compartment intended for installation of master gyrocompass shall comply with the following requirements:

**.1** be as close as possible to the centre line of the ship and to the midship section at the level of one of the existing waterlines;

**.2** be insulated against moisture and penetration of dust, soot, steam, water, smoke and noxious exhalations. It is recommended that air conditioning shall be provided;

**.3** in addition to main lighting, be provided with portable and emergency electric lighting, as well as with means of two-way communication with the navigating bridge. The communication shall be of two-way system or be part of the ship's control communication system (automatic telephone station may be used as a duplicate means of communication);

**.4** instruments or equipment not related to the technical aids of navigation shall not be installed in the compartment;

.5 it is not permitted to lay the pipelines through the compartment excepting the pipeline of gyrocompass cooling system.

### 3.6 LOG TRUNK AND/OR ECHO SOUNDER TRUNK

**3.6.1** The log trunk and/or echo sounder trunk shall comply with the following requirements:

.1 the size of the trunk shall be sufficient to allow the access to the converters;

.2 the trunk shall be closed by a sliding door or have the manhole provided with a cover tightened with folding bolts. Control cock shall be fitted on the cover or on the coaming of the trunk;

.3 for the purpose of descent, the trunk shall be provided with an ordinary or spar ladder;

.4 the trunk shall be tested for tightness in compliance with the requirements specified in Appendix 9 to section 2, Part V "Technical Supervision During Construction of Ships" of the Rules for Technical Supervision During Construction of Ships and Manufacture of Materials and Products for Ships;

.5 the trunk shall be provided with permanent electric lighting and a socket outlet for a portable electric lamp rated for a voltage of not more than 50 V.

**3.6.2** In oil tankers where the log and/or echo sounder trunks are located in way of cargo tanks, the following requirements shall be complied with (see also 3.7.4.6):

.1 the trunk shall be separated from the cargo tanks by cofferdams;

.2 feeding cables and wiring inside the space shall be laid in gastight steel pipes (see also 3.8.3 of the present Part and 2.2.2.9, Part XI "Electrical Equipment" of Rules for the Classification and Construction of Sea-Going Ships);

.3 effective ventilation of the space shall be provided;

.4 the construction of the tightening gear of the manhole shall not be of spark-formation type.

### 3.7 ARRANGEMENT OF NAVIGATIONAL EQUIPMENT ON BOARD SHIP

#### 3.7.1 Magnetic compass.

**3.7.1.1** Magnetic compass shall be so installed and secured that its vertical plane which passes through the lubber lines will not deviate from the centre line of the ship or its parallel plane by more than  $0,2^\circ$ .

**3.7.1.2** The standard magnetic compass shall be installed on the upper bridge in an open place which shall provide for taking visual bearings over an arc of the horizon of  $360^\circ$ .

All-round free access to standard compass shall be provided.

On ships with gross tonnage less than 150 with no compass bridge the location of standard magnetic compass is in each case subject to special consideration by the Register.

**3.7.1.3** The place where the standard magnetic compass is installed and the main steering position shall be interconnected by means of a voice pipe or by any other means of two-way communication.

**3.7.1.4** The main and emergency steering positions shall be interconnected by telephone or other means of two-way communication.

**3.7.1.5** Any object in the vicinity of the standard magnetic compass, which was not provided in the original plan of the arrangement of the compass, may be fitted only if specially agreed with the Register (see 3.1.3).

**3.7.1.6** A master magnetic compass shall be installed aboard ship when the ship is equipped with the magnetic compass with electric remote transmission of dial readings, operating from a special sensitive element, if the latter cannot be used as a master compass.

**3.7.1.7** Special sensitive element of the magnetic compass with electric remote transmission of dial readings, which is not intended for use as a master compass shall be installed in ship in such a place where the effect of ship's magnetic fields is at its minimum and where the easy maintenance of the sensitive element by the navigator is ensured.

**3.7.1.8** The complete sets of magnetic compasses intended for installation in ships of non-restricted area of navigation shall include spare compensating magnets.

**3.7.1.9** Every ship shall be provided with the magnetic compass residual deviation table drawn up by a competent authorized body.

The Register fulfils no supervision functions of the procedure of timely and qualified determination and compensation of the deviation of magnetic compasses.

**3.7.1.10** A standard magnetic compass with optical remote transmission of dial readings shall be installed on board in compliance with the requirements specified in 3.7.1.1 to 3.7.1.5. In addition, the following requirements shall be complied with:

.1 the periscope screen shall be preferably at eye level of a helmsman and at a distance not exceeding 1,2 m;

.2 there shall be no dead angles of visibility in the periscope tube for a helmsman.

#### 3.7.2 Gyrocompass.

**3.7.2.1** The compartment intended for installation of the master gyrocompass shall comply with the requirements of 3.5.

**3.7.2.2** It is allowed to install the master gyrocompass in the wheelhouse or in the chartroom,

provided the overall dimensions of the master gyrocompass are not large.

**3.7.2.3** Gyrocompass shall be supplied from the main and emergency switchboards by two independent feeders.

**3.7.2.4** Automatic change-over device shall be provided capable of switching the gyrocompass power supply from the main switchboard to the emergency electric station switchboard (where an emergency diesel-generator is installed) in the event of failure of the main supply (see also Part XI "Electrical Equipment" of Rules for the Classification and Construction of Sea-Going Ships).

**3.7.2.5** Free access to the master gyrocompass shall be provided. Easy and unhindered opening of lids and covers, as well as free access to terminal plates shall be provided.

**3.7.2.6** Bearing repeater shall be installed on the upper bridge, the requirements of 3.7.1.2 being strictly complied with, or one repeater shall be installed at each wing of the navigating bridge, thus providing for the field of view at least 180° right ahead on each side of the ship when taking bearings.

**3.7.2.7** Steering repeaters shall be installed at steering position of the ship. The location of steering repeaters shall provide for their convenient use by helmsman.

Where the wheelhouse is provided with the central control desk of the ship's heading and/or track control system with a built-in gyrocompass repeater, the installation of the separate steering gyrocompass repeater is not required.

If emergency rudder control station is provided on board the ship, gyrocompass repeater shall be fitted in close vicinity to it.

**3.7.2.8** The 0 — 180° lines of the master gyrocompass and bearing repeaters shall lie in the ship's centre line plane or parallel to it with an accuracy specified in 3.7.1.1.

**3.7.2.9** Power supply units and their starting and control apparatus shall be installed in the generator room, if any, or in the master gyrocompass compartment in a position which facilitates taking measurements of running speed of these units and maintenance of their bearings. Knobs for starting and remote control of the power supply unit shall be fitted in the same compartment where the master gyrocompass is installed or in the wheelhouse.

**3.7.2.10** It is allowed to install in ships both a gyrocompass and a magnetic compass with electric remote transmission of dial readings and to use the same repeaters for both compasses. In this case, a light signal "Repeaters switched to magnetic compass" shall be provided in the wheelhouse. This signal shall automatically be switched on when the repeaters are connected to the operation from the magnetic compass impulser.

**3.7.2.11** Water-cooled gyrocompasses the design of which provides for their normal functioning at the cooling water temperature up to +3 °C shall be supplied with cooling water from a special cooling arrangement installed on board.

**3.7.2.12** The requirements of 3.5.1.4 do not apply to ships of less than 300 gross tonnage. The compliance with requirements of 3.5.1.1 to 3.5.1.3, 3.7.2.3 is recommended for such ships.

### **3.7.3 Log.**

**3.7.3.1** Primary speed transducers shall be installed in the bottom of the ship, preferably in the vicinity of the place of intersection of the base line and centre line of the ship in such a way that the transducers remain under water at the lightest draught of the ship and when the ship is rolling.

**3.7.3.2** No projecting parts of the hull, suction and discharge openings likely to affect the parallelism of stream lines washing the ship shall be located forward of the primary transducers.

**3.7.3.3** Electromagnetic transducers may be installed in sluice valves or they may be permanently fixed. Electromagnetic transducers shall be so installed that their longitudinal axes are parallel to the centre line of the ship with an accuracy not less than  $\pm 1^\circ$ .

**3.7.3.4** The sluice valves shall be fitted in a special trunk complying with the requirements of 3.6.

**3.7.3.5** Fixed electromagnetic transducers in the openings cut in the ship's bottom shall be adequately secured in the appropriate welded boxes being equivalent in strength to the ship's hull.

**3.7.3.6** Speed and distance repeaters shall be installed in the place where the navigational plotting is performed.

Speed repeaters shall be installed in the wheelhouse and in the navigating bridge wings fitted with the steering posts of the main engine.

Where a main machinery control room is provided in the ship's engine room, installation of the speed repeaters in such control room is recommended.

**3.7.3.7** Where the combined indicators of the navigational information of television type are available in the navigating bridge, some speed and distance repeaters need not be installed in the bridge except for the speed repeater in the automatic remote control desk or in close proximity to it.

### **3.7.4 Echo sounder.**

**3.7.4.1** The depth indicator shall be installed in the wheelhouse, and the depth recorder in the wheelhouse or in the chartroom, if any, in the place and at a distance providing their most convenient use and operation.

In certain cases, if agreed with the Register, it is allowed to install only one of these devices, it shall then be located in the wheelhouse.

**3.7.4.2** The vibrators of the echo sounder shall be installed in the ship's bottom clear of its sides and ends in places least affected by ship's vibration and at a distance which prevents them from being emerged out of water when the ship is rolling.

It is recommended to install the vibrator at a distance of 0,2 to 0,75 of the ship's length from the stem, as measured along the plane of the waterline, which corresponds to the lightest service draught of the ship and close to the centre line of the ship.

**3.7.4.3** In the vicinity of the vibrator there shall be no supersonic emitting devices of other instruments operating simultaneously with the echo sounder, as well as no projecting parts of the hull, discharge and suction openings, etc., which are likely to disturb the normal operation of echo sounders.

These requirements shall also be taken into consideration when portable vibrators are provided.

**3.7.4.4** Measures shall be taken to prevent corrosion of the ship's hull as a result of the installation of the vibrators.

**3.7.4.5** It is recommended to install vibrators in special spaces (trunks) (see also 3.6).

**3.7.4.6** It is allowed to install vibrators of echo sounders in cofferdams of cargo and oil fuel tanks, in double bottom tanks and in ventilated tunnels under cargo tanks of oil tankers, provided they are situated in a special gasproof recess which is an integral part of the hull structure (see also 3.8.3 of the present Part and 2.2.2.9, Part XI "Electrical Equipment" of Rules for the Classification and Construction of Sea-Going Ships). Feeding cables shall be mounted in gasproof steel pipes.

The vibrators installed in the above spaces shall be of unattended design.

**3.7.4.7** The vibrators shall be so installed that their emitting and receiving surfaces are parallel to the horizontal plane and on one level when the ship is on even keel and is not inclined.

This requirement also applies to portable vibrators.

The deviation from the horizontal plane of not more than  $\pm 3^\circ$  is permissible for vibrators installed in bottom slot.

**3.7.4.8** The vibrators installed in bottom slots shall be so arranged that their emitting surface is on one level with the shell plating of the ship's hull. Where it is impossible to install the vibrators in horizontal plane due to the curvature of the ship's hull, it is recommended to use special stream-liners arranged in bow — stem direction.

**3.7.4.9** Additional strengthening measures shall be applied, where necessary, to increase the rigidity of the shell plating when the vibrators are installed in bottom slot.

**3.7.4.10** Where the vibrators are installed in a special tank, without slotting the ship's bottom, the

tank shall be filled up with the liquid having acoustic characteristics as similar to those of sea water as possible.

**3.7.4.11** Special tanks intended for the installation of vibrators shall be, after the latter were fitted on board ships, tested for tightness in compliance with the requirements specified in Appendix 1 to Part II "Hull" of Rules for the Classification and Construction of Sea-Going Ships.

**3.7.4.12** In no case shall the emitting surface of the vibrators be painted or subjected to any mechanical effects (shocks, hard friction, etc.).

**3.7.4.13** For the purpose of examining the cable boxes and checking the insulation of the vibrators free access to them shall be provided from the inside of the ship.

**3.7.4.14** Power supply equipment of the echo sounder (converters, transformers, etc.) shall be installed in the generator room or in a special recess located in the interior ship's compartments capable of being heated.

### **3.7.5 Rate-of-turn indicator.**

**3.7.5.1** The main instrument of the rate-of-turn indicator shall be fitted on the rigid base in the generator room or in the equipment room in the vicinity of the wheelhouse. The upper surface of the base shall be parallel to the main (horizontal) plane of the ship.

It is allowed to install the main instrument in the wheelhouse provided the requirements of 3.1.3 and the permissible acoustic level are fulfilled.

**3.7.5.2** The repeaters of the rate-of-turn indicator shall be arranged in the wheelhouse in the vicinity of the steering station or in another place in the ship from which steering may be controlled, as well as on the wings of the navigating bridge.

**3.7.5.3** The instruments of the rate-of-turn indicator shall be arranged on the navigating bridge in such a way as to ensure convenient observation of the range scales and easy access to the controls.

### **3.7.6 Radar.**

**3.7.6.1** The main radar display (means for presenting radar and additional navigation-related information) shall be installed near the navigating bridge forward bulkhead in such a way as not to impair visual observation ahead of the ship, along the ship's heading, and the display image shall not be impaired by any lighting conditions.

If an additional display is provided on board ship, it should be installed near the place of performing navigational plotting.

If the radar control panel is a separate device, it should be possible to monitor the radar equipment from all the work stations where radar displays and additional navigation-related information displays are installed.

**3.7.6.2** It is allowed to install the transmitter and other equipment of the radar on the bridge, provided the flux density of the power of high-frequency emissions, mechanical noise level and the level of electric interference to radio reception caused by this equipment do not exceed the permissible rates. Otherwise, the above-mentioned equipment shall be installed in a special enclosed and well-screened compartment.

**3.7.6.3** The diagrams indicating radar blind sectors shall be located near displays.

**3.7.6.4** If a second radar is provided on the ship, its display shall also be installed on the ship's navigating bridge.

In this case the main radar display shall be placed closer to the ship's starboard, and the second radar display — to portside.

### **3.7.7 Bridge Navigational Watch Alarm System (BNWAS).**

**3.7.7.1** A Bridge Navigational Watch Alarm System (BNWAS) with a device intended for the BNWAS to return to its initial state shall be installed on the ship's navigating bridge in accordance with the requirements of the Rules for Bridge Design, Equipment, Arrangement and Procedures (see Appendix to this Part of the Rules).

**3.7.7.2** The device structure shall ensure that it can be used only by the watch-keeping officer on the ship's navigating bridge and shall be protected from accidental use by unauthorized persons.

**3.7.7.3** To facilitate ship's navigation and manoeuvring, a special "Emergency Call" key may be installed at the bridge workstation. The key is intended for immediate sounding, in case of necessity, an audible alarm signal of the second, and then, third level to call another watch-keeping officer and/or the master.

### **3.7.8 Radar reflector.**

**3.7.8.1** The radar reflector shall be fitted either on a rigid mount or suspended on a proper rigging at places not shaded by the superstructures and other metal structures.

The height of installation shall be not less than that indicated in 5.9.2.

**3.7.8.2** For ships and floating facilities with gross tonnage less than 150 the maximum weight of radar reflector for mounting at 4 m shall not exceed 5 kg.

Radar reflectors designed for mounting at a height greater than 4 m shall be of respective weight recalculated pro rata. The overall dimensions of radar reflector shall be minimized and shall not exceed 0,05 m<sup>3</sup>.

### **3.7.9 Universal automatic identification system.**

**3.7.9.1** The universal automatic identification system (AIS) equipment shall be so installed in the wheelhouse that the AIS display (if any) and the controls, and the radar, ARPA, and ECDIS displays, may be used readily, and to allow observation of the situation around the ship.

**3.7.9.2** Separate units comprising the universal automatic identification system which are not used frequently may be installed in the operating room or in a special enclosure in the vicinity of the wheelhouse.

**3.7.9.3** Output contacts of relay initiated at the detection of the AIS failure, shall be connected to the audible alarm device.

As the audible alarm device, a loud speaker integrated in the AIS equipment, an independent external alarm or alarm system located on the navigating bridge may be used.

### **3.7.10 Radionavigation system receiver.**

The radionavigation system receiver indicator shall be installed in close proximity to the place where the navigational plotting is maintained.

### **3.7.11 Combined ship control desk.**

**3.7.11.1** Combined ship control desks shall be arranged in the wheelhouse. In this case the requirements of 3.2 shall be met.

**3.7.11.2** Depending on the design of the combined ship control desk adopted in compliance with the requirements of 5.13.4, it shall be arranged in the wheelhouse symmetrically to the centre line, or parts or sections of the desks may be installed to the right or to the left from the centre line, provided the requirements of 5.13.13 are met.

**3.7.11.3** One of the steering gear remote controls shall be arranged in the centre line. Course and rudder blade indicators shall be so located that the possibility is provided for taking readings from any point of the wheelhouse.

**3.7.11.4** In addition to the manual controls for whistles provided by 5.13.2.6 and arranged in compliance with 5.13.13, provision shall be made for similar manual controls at the extreme sections of the desk in the wheelhouse and at the sections located on the wings of the navigating bridge (see also 4.6.2, Part III "Signal Means").

### **3.7.12 Integrated navigational system.**

**3.7.12.1** Control panels of the navigational devices forming a part of the integrated navigational system, display units and input-output devices may be arranged in separate sections of the navigational desk.

**3.7.12.2** Integrated navigational system shall be installed in the wheelhouse or in the chartroom so that the operator can use the navigational equipment and keep a proper look-out.

**3.7.12.3** Separate kinds of navigational equipment forming a part of the integrated navigational system which do not require the constant observation and operational control may be installed in the equipment room or in specially enclosed compartment close to the wheelhouse (chartroom).

### **3.7.13 Unified timing system.**

**3.7.13.1** The unified timing system station shall be installed on the navigating bridge in such location as to permit its easy maintenance.

**3.7.13.2** The controllable clock with the digital read-out provided for the service rooms shall be located in the wheelhouse and in the main machinery control room.

**3.7.14 Navigational instruments and appliances.**

The navigational equipment specified in Table 2.2.1, items 19 to 27, shall be arranged and stored in the places from which the steering control of the ship is effected (wheelhouse, chartroom).

**3.7.15 Radiobeacon station.**

Radiobeacon station the emissions of which are intended to enable a mobile station to determine its bearing or direction in relation to itself shall be installed in the space convenient for maintenance, in close proximity to aerial lead-in.

**3.7.16 Electronic chart display and information system (ECDIS).**

The electronic chart display and information system shall be installed in the wheelhouse so as to be convenient to use the system display and controls, radar and ARPA displays and observe the environment.

**3.7.17 Heading and/or track control system (autopilot).**

**3.7.17.1** The control panel of the regular manual steering system shall be connected with manual control panel of a mechanical or electrical transmission and shall be installed next to it.

**3.7.17.2** The combined manual and automatic control panel shall be installed on the navigating bridge in the centreline of the ship so as to provide easy maintenance and quick switching from automatic to manual control and vice versa.

The displacement of the control panel to the right of the centerline is allowed on ships where masts, cranes, other deck structures obscure visibility of the fore end. In this case special mark shall be provided in the fore end visible in the daytime and at night.

**3.7.17.3** The remote control panels of the system shall be installed on the bridge wings or in places convenient for their use.

**3.7.18 Sound reception system.**

**3.7.18.1** The receiving microphones shall be installed in such a way that the acoustic interference level from the ship's noise sources would be minimum.

**3.7.18.2** The system display shall be visible from the ship's main conning position.

**3.7.18.3** The system loudspeakers shall be installed so that incoming sound signals are audible at all positions of a wheelhouse.

**3.7.19 Voyage data recorder/simplified voyage data recorder.**

**3.7.19.1** The voyage data recorder/simplified voyage data recorder equipment is arranged on the ship's navigating bridge or in close proximity to it.

**3.7.19.2** The place where a special protected detachable container with the data carrier is installed

may be different for different ship designs and is subject to special consideration by the Register in each case.

The special protected float-free container of a simplified voyage data recorder shall be installed on the ship's open deck so as to ensure its free floating in any conditions of ship's sinking.

**3.7.19.3** Microphones of VDR/S-VDR positioned on the navigating bridge shall be so placed that conversation near the conning stations, radar displays/ARPA, chart tables are adequately recorded. The positioning of microphones shall also capture audible alarms as well as voice orders transmitted through the command broadcast apparatus, intercom systems.

### 3.8 CABLING

**3.8.1** All outer cabling of the shipboard navigational equipment shall be made by means of screened cables and laid in compliance with the requirements of Part XI "Electrical Equipment" of Rules for the Classification and Construction of Sea-Going Ships.

**3.8.2** Insulation resistance of every laid cable disconnected at both ends shall be not less than 20 Mohm, irrespective of the cable length.

**3.8.3** To eliminate electromagnetic interferences in the echo sounder diagram, the line transducer-receiver-amplifier shall be distant from the line vibrator-radiator by not less than 1 m from other electrical equipment and 0,5 m from the cables laid in parallel. Both lines shall be made by means of reliably screened cables. Cables running to the vibrators arranged in spaces below the bulkhead deck shall be laid in steel pipes.

**3.8.4** For radar installation all shielded cables and all shielded coaxial cables shall be laid in accordance with the technical specifications of the radar Manufacturer, and the requirements of 3.8.1 shall be considered.

**3.8.4.1** To reduce the signal weakening, the cables shall be as short as possible.

**3.8.4.2** To minimize the electromagnetic interference effect, all cables between the antenna and other radar blocks shall be laid in runs which are as straight as possible and, if necessary, cross each other at right angle.

**3.8.4.3** No cables shall be laid near high voltage sources.

**3.8.4.4** To prevent moist from penetrating into the cables, all connections on the ship's open deck shall be of waterproof (IP56) type.

**3.8.4.5** When laying the cables and microwave transmitting feeders, minimum internal bending radii are to be maintained.



## 4 AERIALS AND EARTHING

### 4.1 GENERAL

**4.1.1** It is allowed to fit a ship with aerials of any type which provide the highest operational efficiency of the navigational equipment in accordance with its purpose.

**4.1.2** Aerials of the navigational equipment shall comply with the requirements of Section 4, Part IV "Radio Equipment".

### 4.2 RADAR AERIALS

**4.2.1** To ensure the maximum target location range and 360° observation, the radar antenna, if the ship's structure permits, shall be installed on a special mast.

The height at which the antenna is installed shall ensure the short range target location and minimize sea clutter and interference due to radiowaves reflection from the sea surface.

At the same time the height at which the antenna is installed shall be such that the flow density of its high frequency output signal at the ship's open decks where people can be present does not exceed the maximum permissible level.

**4.2.2** If scanning is effected straight ahead of the ship, it is admissible that the sea surface will not be scanned at a distance of not more than 500 m or double length of the vessel, whichever is shorter, for any type of cargo, ship's draught or trim.

Blind sectors shall be reduced to minimum and shall not be observed along an arch of horizon from straight ahead of the ship to the directions of 22,5° abaft the beam on each side of the ship.

Any two blind sectors separated from each other by an angle of 3° or smaller shall be regarded as one blind sector.

Separate blind sectors, the angle of which exceeds 5°, or the resultant arch of which exceeds 20° shall not be observed in the rest arch of horizon.

**4.2.3** If two radars are installed on board, their antennas shall be installed in such a way as to minimize blind sectors and eliminate their mutual interference during their simultaneous operation.

**4.2.4** If two radar antennas are installed close to each other, the angle between them in the vertical plane shall be at least 20°, and the minimum distance between them in the vertical plane shall be at least 1 m.

**4.2.5** The radar antenna shall be installed in such a place on board where neither ship's structures nor deck cargo can reflect electromagnetic radiation.

**4.2.6** The radar antenna shall be installed far from the high frequency radiation sources and other transmitting/ receiving radio equipment antennas.

**4.2.7** If the antenna is installed on a special mast, the platform for its technical servicing and repairing shall have an area of at least 1 m<sup>2</sup> and shall be provided with protective rails which do not restrict the antenna rotation. The radar antenna lower edge shall be situated at least 500 mm higher than any rail of the platform.

In all cases it should be possible to inspect and repair any part of the antenna.

The structure of the mast with the antenna platform shall be designed so as to take into consideration the vessel's operational conditions, possible vibration and impacts.

**4.2.8** If the antenna is installed at an easily accessible place, it shall be placed at least 1800 mm above the deck, ladder or any other place where people can be present.

**4.2.9** The radar antenna shall be installed at a safe distance from the ship's magnetic compass.

**4.2.10** All guys of the radar antenna mast shall be provided with insulators dividing the mast into unequal parts with lengths ranging from 2 to 6 m. If it is impossible to insulate the guys they shall be electrically bonded to the ship's hull.

### 4.3 AERIALS OF UNIVERSAL AUTOMATIC IDENTIFICATION SYSTEM (AIS)

**4.3.1** The universal automatic identification system (AIS) aerials shall be installed at a maximum height so as to allow effective transmission and reception of signals at all operating frequencies, and to avoid obstructions to electromagnetic field propagation over the entire horizon as far as practicable.

The manufacturer's recommendations shall be taken into consideration.

### 4.4 AERIALS OF RADIONAVIGATION SYSTEM RECEIVERS

**4.4.1** Receiver antennas shall not be installed lower than ship's large-size metal structures and shall be situated at a distance of at least 3 m from any transmitting antennas.

**4.4.2** The antennas shall not be installed on the mast tops, at places subject to substantial vibration, under deck structures and rigging or near sources of heat or smoke.

**4.4.3** The position for a GNSS system receiver antennas shall be chosen so as to ensure unrestricted tracking of a satellite constellation signal and be situated at least 1m higher than other horizontal surfaces of the ship's structures.

**4.4.4** The GNSS receiver antennas shall not be installed along the axis of the main lobe of the radar antenna direction diagram, nor shall they be installed in the same plane with the INMARSAT Ship Earth Station antennas.

The distance between the above mentioned antennas shall be at least 10 m.

**4.4.5** If antennas are installed on small tonnage ships, the recommendations of the receiver Manufacturer are to be considered.

#### 4.5 EARTHING

**4.5.1** Navigational equipment installed in a ship shall have a protective earthing to the ship's hull which shall be made as short as possible.

**4.5.2** When leading in the cables into the equipment, their screened sheathings shall be electrically connected to the ship's hull.

**4.5.3** All radionavigational devices shall have the operational (high-frequency) earthing as well.

**4.5.4** The total resistance of all electric connections of any earthing shall not exceed 0,02 Ohm.

## 5 TECHNICAL AND OPERATIONAL REQUIREMENTS FOR NAVIGATIONAL EQUIPMENT

### 5.1 GENERAL

**5.1.1** Navigational appliances, devices and instruments shall be, so far as practicable, simple in design and electric wiring, easy for maintenance and safe in operation.

Navigational equipment shall be capable of continuous and consistent functioning under different sea states and ship's movement parameters, under conditions of vibration, humidity and temperature the ship may encounter in service.

**5.1.2** All navigational equipment intended for being constantly under twenty-four-hours operating conditions shall be of appropriate protected design and shall operate reliably as specified in 5.1.41, Part IV "Radio Equipment". The working temperature for log primary speed transducers and echo-sounder vibrators in water shall range from  $-4^{\circ}\text{C}$  to  $+40^{\circ}\text{C}$ .

**5.1.3** Depending on the location of the navigational appliances, devices and instruments on board ship, the degree of their protection shall be at least:

- .1 IP22 — for enclosed dry service spaces;
- .2 IP56 — for open decks and cargo holds;
- .3 IP68 — for double bottom recesses.

IP21 is permitted for the equipment installed in the enclosed dry service spaces at a distance more than 1 m from the doors and windows facing the open deck.

**5.1.4** All navigational appliances, devices and instruments shall be provided with proper fittings for efficient securing in the regular places.

It is allowed to use adequate shock absorbing appliances.

**5.1.5** On the external side of housing of each navigational appliance, device and instrument the following data shall be marked: manufacturer's name, type or model, serial number and date of manufacture.

**5.1.6** The navigational equipment to be installed near the magnetic compass shall be provided with clear inscriptions indicating the minimum safe distance, at which it can be located away from the compass. The minimum safe distance to the magnetic compass shall be deduced by recognising that at this distance the influence of the specific navigational equipment (or individual unit) in "on" position is such that the deviation of the magnetic compass does not exceed  $5,4^{\circ}/\text{V}$  for magnetic compasses installed on the upper bridge and not less than  $18^{\circ}/\text{V}$  for magnetic compasses installed inside the navigating bridge (where V (T) is the horizontal component of the Earth magnetic field induction).

**5.1.7** Number of the controls, their location and method of functioning, place and interlocation as well as their size shall be such as to permit their easy, quick and effective operation. Operations controls whose unintended use may result in switching-out, damage or incorrect functioning of equipment shall have the special protection against an unauthorized access.

Controls requiring frequent or accurate settings shall not be placed more than 675 mm from the front edge of the console/device, and they shall be located so that simultaneous operation of two controls will not necessitate a crossing or interchanging of hands.

**5.1.8** Each complete set of navigational equipment shall be designed for being served by one operator only.

**5.1.9** All housings of navigational equipment operating under voltages exceeding standard safety value, as well as other equipment which is likely to produce radio interference shall be provided with special terminals for connecting earthing conductors.

**5.1.10** Special design precautions shall be provided to protect the operator against electrical shocks when replacing fuses.

**5.1.11** The design and arrangement of plug sockets and other easily removable disconnecting devices shall exclude any possibility of their wrong connection.

**5.1.12** All equipment shall be fitted with special devices or interlocks to protect the operating personnel against electrical shock caused by high voltage after opening the housing of a device or instrument for the purpose of inspection, cleaning, repair and replacement of interior parts.

On opening the housing of device or instrument, the voltage of capacitors being under high voltage shall automatically be reduced to the level not exceeding 55 V.

**5.1.13** Navigational equipment shall be designed for being supplied with electric current of one or several following voltages from the ship's mains:

- .1** direct current — 24, 110 and 220 V;
- .2** single-phase alternating current with frequency 50 Hz — 110, 127 and 220 V;
- .3** three-phase alternating current with frequency 50 Hz — 220 and 380 V.

**5.1.14** The design of all navigational appliances, devices and instruments shall ensure maintaining their technical parameters when the voltage and frequency of the ship's alternative current mains vary within  $\pm 10$  per cent and 5 per cent respectively for a prolonged period of time and also when the supply voltage deviates from the rated voltage by +30 per cent and -10 per cent in the event of power supply from the accumulator batteries and ship's direct current mains.

Navigational equipment shall maintain its serviceability under the short-term deviations of the ship's mains voltage within  $\pm 20$  per cent during 1,5 s and of the frequency within  $\pm 10$  per cent during 5 s. In this case the alarm signalling system shall not start functioning.

The design of navigational equipment shall provide its protection against the accidental polarity reversal of the source of power.

**5.1.15** Insulation resistance for separate circuits of devices or instruments shall be not below the values indicated in Table 5.1.15.

**5.1.16** Navigational equipment shall meet the following requirements which ensure the electromagnetic compatibility (EMC) on board ship.

**5.1.16.1** The voltage level of conducted interference from navigational equipment at the electric

Table 5.1.15

| Test conditions  | Insulation resistance, MOhm |
|--|-----------------------------|
| Normal climatic conditions   | 20                          |
| Temperature $(50 \pm 2)^\circ\text{C}$ . Relative humidity below 20 per cent     | 5                           |
| Temperature $(40 \pm 2)^\circ\text{C}$ . Relative humidity $(95 \pm 3)$ per cent | 1                           |

power supply terminals shall not exceed values shown in Fig. 5.1.43.1, Part IV "Radio Equipment".

**5.1.16.2** The intensity level of radiated interference field produced by navigational equipment (except for primary transducers of logs and transducers of echo sounders) at a distance of 3 m from the casing shall not exceed values shown in Fig. 5.1.43.1, Part IV "Radio Equipment".

**5.1.16.3** Navigational equipment shall be immune to conducted low-frequency interference when the following additional test voltages are imposed on supply voltage within the frequency range from 50 Hz to 10 kHz:

**.1** for equipment with D.C. power supply — sine voltage the actual value of which is 10 per cent of the rated supply voltage;

**.2** for equipment with A.C. power supply — sine voltage the actual value of which, in relation to the rated supply voltage, varies with the frequency as shown in Fig. 5.1.43.1, Part IV "Radio Equipment".

**5.1.16.4** Navigational equipment shall be immune to conducted interference when the following test sine voltages are applied to input terminals of the power supply sources, signalling and control circuits of equipment:

**.1** with an actual voltage value of 3V at the frequency which varies from 10 kHz to 80 MHz;

**.2** with an actual voltage value of 10 V at the points with frequencies: 2 MHz; 3 MHz; 4 MHz; 6,2 MHz; 8,2 MHz; 12,6 MHz; 16,5 MHz; 18,8 MHz; 22 MHz and 25 MHz.

Modulation frequency of the test signal shall be  $400 \text{ Hz} \pm 10$  per cent with modulation depth of  $80 \pm 10$  per cent.

**5.1.16.5** Navigational equipment except for primary speed transducers and vibrators of the echo sounders) shall be immune to radiated radio frequency interference, when located within a modulated electric field with an intensity of 10 V/m when the test signal frequency varies from 80 MHz to 2 GHz.

Modulation frequency of the test signal shall be  $400 \text{ Hz} \pm 10$  per cent with modulation depth of  $80 \pm 10$  per cent.

**5.1.16.6** Navigational equipment shall be immune to interference induced by fast transients when the following test pulse voltage are applied to input terminals of the power supply sources, signalling and control circuits of the equipment:

**.1** with an amplitude of 2 kV and repetition frequency of 2,5 kHz — at the differential inputs of A.C. power supply sources;

**.2** with an amplitude of 1 kV, in relation to the common earthed input, and with a repetition frequency of 5 kHz — at the inputs of signalling and control circuits.

The test signal rise time in this case shall be 5 ns (at 10 to 90 per cent amplitude level), 50 ns — pulse duration (at 50 per cent amplitude level).

**5.1.16.7** Navigational equipment shall be immune to interference induced by slow transients when a test pulse voltage with amplitudes: 2 kV — line/earth, 1 kV — line/line is applied to its A.C. power supply circuits.

The test signal rise time in this case shall be 1,2 µs (at 10 to 90 per cent amplitude level), duration — 50 µs (at 50 per cent amplitude level), repetition frequency — 1 pulse/min.

**5.1.16.8** Navigational equipment shall remain operative at power supply failure that involves loss of supply voltage during 60 s. In this case, the possibility of failure of the software and loss of the on-line data shall be ruled out.

**5.1.17** Fitted directly on navigational appliances and devices, fuses and switches or circuit-breakers shall be provided, these being installed in power supply circuits and designed for appropriate operational currents and voltages.

It is recommended to fit fuses, switches and circuit-breakers in such places where the replacement of fuses or manual switching on of circuit-breakers or switches may be effected by the operator without opening the housing of device or instrument.

**5.1.18** Visual indicators of readings and built-in electromeasuring instruments of permanent operational use shall be mounted on the front panel of the navigational device or instrument.

The instrument means of control shall be mounted on the front panel or in some other readily accessible place.

**5.1.19** Means of control and monitoring shall be provided with distinct inscriptions and/or generally accepted designations and markings showing their purpose and operation.

Indications of devices and inscriptions on operations controls shall ensure their readings at a distance not less than 1 m. All other information shall be read at a distance not less than 2 m.

**5.1.20** Means of control and adjustment which are not used in routine everyday operation of the device or instrument may be mounted inside the housing, and/or they shall have spline adjustment.

**5.1.21** Navigational appliances, devices and instruments shall be provided with proper lighting of front panels on which the means of control and

adjustment are mounted; in this case, the requirements of 5.1.29 shall be complied with.

**5.1.22** If the electron-ray indicator is provided in the navigational equipment, measures shall be taken to keep the indication under observation in the day-time.

**5.1.23** The design of navigational appliances, devices and instruments shall prevent the control handles from heating by the interior heat radiation to temperature exceeding the ambient temperature by more than 15°C.

**5.1.24** The diagram and design of navigational appliances, devices and instruments shall preclude any possibility of damage as a result of wrong sequence in manipulating the means of control.

**5.1.25** All navigational appliances, devices and instruments shall be provided with proper visual signalling system to indicate their "on" position.

It is also recommended to provide a visual signalling system to indicate high-voltage "on" position and the most important switching of the equipment to various essential operations.

**5.1.26** Navigational appliances and devices shall be provided with audible and/or visual signalling system capable of indicating any fault in the equipment operation.

It is recommended that such signalling system is automatically switched on when critical load level in the equipment operation is likely to lead to its being put out of action.

The acoustic noise level produced by the audible alarm at a distance of 1 m from the noise source shall be within the range from 75 to 85 dB.

The types of signalling systems and faults or critical load levels, for which the signalling systems are intended, are, in each case, subject to special consideration by the Register.

**5.1.27** Signal lamps and other means of visual control shall be fitted in the devices, instruments or control panels and shall be clearly visible to the operator in diffused daylight.

**5.1.28** The colours of signal lamps used for each particular kind of signalling system shall comply with the colours adopted in Part XI "Electrical Equipment" of Rules for the Classification and Construction of Sea-Going Ships.

**5.1.29** Lighting intensity of the signal, indicator and lighting lamps of the devices and instruments installed in the wheelhouse shall not interfere with the normal work of the helmsman and the navigator.

The lighting intensity shall be capable of being regulated.

**5.1.30** For manufacture of navigational appliances and devices the materials shall be used according to Part XI "Electrical Equipment" of Rules for the Classification and Construction of Sea-Going Ships.

**5.1.31** Navigational devices shall be capable of interfacing to other radio and navigational equipment and also to an integrated navigation system.

Formats used for numerical information exchange shall be in compliance with the International Standard on Interface of Marine Radio and Navigational Equipment.

**5.1.32** Navigational equipment (except for primary speed transducers and vibrators of the echo sounders), shall not fail when electrostatic discharges aboard the ship act on its external surfaces (6 kV when contacted and 8 kV for a space discharge).

**5.1.33** The ambient noise level produced by radio equipment during its operation (with the audible alarm switched off) shall not exceed 60 dB at a distance of 1m from any part of the equipment.

**5.1.34** Navigational devices with several modes of operation shall have an indication of a mode in use.

**5.1.35** The operative software of navigational equipment shall be protected against an unintended access. If malfunctions arise, an automatic functioning control of software and alarm shall be provided.

**5.1.36** The information in maintenance documentation shall be sufficient for proper use of navigational equipment by ship's personnel.

Navigational equipment, designed so that malfunctions diagnostics and the following repair are possible up to the circuitry, shall have a set of electric circuits and wiring diagrams and also equipment components specification.

Maintenance documentation for navigational equipment consisting of separate modules, whose repair on board the ship is not provided, shall include a procedure for detection and replacement of a failed module.

**5.1.37** The display devices used within the navigational equipment, with the screen diagonal not more than 0,5 m (with the exception of devices which display not more than four information lines) shall not produce magnetic induction exceeding 200 nT within frequency band of 5Hz to 2kHz and exceeding 25nT within frequency band of 2 to 400 kHz at a distance of 50 cm from the device, and in this case the magnetic induction level at a distance of 30 cm from the face of the display screen shall not exceed 200 nT within frequency band of 5 Hz to 2 kHz. The strength of the magnetic field induced by the display device at a distance of 50 cm in all directions from the device shall not exceed 10 V/m within frequency band of 5 Hz to 2 kHz and 1 V/m within frequency band of 2 to 40 kHz; along with that, at a distance of 30 cm from the face of the display screen the strength of the induced electromagnetic field shall not exceed 1 V/m within frequency band of 2 to 400 kHz. The electrostatic field strength at a distance of 10 cm from the face of the display screen shall not exceed  $5,0 \pm 0,5$  kV/m.

For the display devices with screen diagonal more than 0,5 m, higher field levels are accepted, in this case, the technical documentation for such devices shall state minimum distances, at which:

magnetic induction does not exceed 250 nT within frequency band of 5 Hz to 2 kHz and does not exceed 150 nT within frequency band of 2 to 400 kHz;

electromagnetic field strength does not exceed 15 V/m within frequency band of 5 Hz to 2 kHz and does not exceed 10 V/m within frequency band of 2 to 400 kHz;

electrostatic field strength does not exceed  $5,0 \pm 0,5$  kV/m.

**5.1.38** The X-radiation level induced by individual units of the navigational equipment (cathode-ray tubes, radar transceiver components, etc.) shall not exceed 5 mcJ/kg (0,5 mrem/hour) at a distance of 5 cm from the surface of the devices.

## 5.2 MAGNETIC COMPASS

**5.2.1** Magnetic compasses shall be capable of indicating the ship's course with the following accuracy:

$\pm 1^\circ$  — ship under way, no rolling;

$\pm 5^\circ$  — ship under way, rolling in all directions up to  $\pm 22,5^\circ$  with a period of 6 to 15 s.

**5.2.2** The compass card of the magnetic compass shall be capable of indicating the reading with accuracy of  $0,5^\circ$ . Graduation division of the compass shall not exceed  $1^\circ$ .

**5.2.3** With the horizontal component of magnetic field H ( $\mu$ T) at the point of compass installation and the temperature of ambient air  $+20 \pm 3^\circ$  C, the magnetic compass card stagnation shall not exceed  $(3/H)^\circ$  after deflecting the compass card from the magnetic meridian by  $\pm 2^\circ$ .

**5.2.4** Magnetic compasses shall be provided with an effective damping device capable of ensuring the compass card stability under ship's vibrations and with a device ensuring normal position of the compass bowl vertical axis under ship's service conditions.

**5.2.5** The compass bowl with gimbal suspension shall retain horizontal position at the binacle inclination to  $45^\circ$  in all directions. The card shall remain free at the bowl inclination in all directions of at least:

$10^\circ$  for compasses with gimbal suspension;

$30^\circ$  for compasses without gimbal suspension.

**5.2.6** Magnetic compasses shall be provided with devices for the compensation of semicircular, intercardinal, inclination and latitude deviation.

Every such device shall be capable of compensating the corresponding deviation with accuracy up to  $\pm 0,2^\circ$ .

**5.2.7** The design of the devices specified in 5.2.6 shall provide for the compensation of deviation with maximum values of residual deviation not exceeding  $\pm 3^\circ$  for the standard magnetic compass and  $\pm 5^\circ$  for the spare magnetic compass.

**5.2.8** Magnetic compasses shall be provided with binnacles and electric lighting sufficient to make the scale divisions of the compass card distinctly visible. The lighting intensity shall be capable of being regulated.

Main electric lighting of the compass shall be supplied from the ship's power plant.

In addition to main lighting of the compass, self-contained source of lighting shall be provided.

**5.2.9** The height of the standard compass binnacle together with the pad it is installed on, shall provide for the plane of the compass bowl glass to be at the height of not less than 1300 mm from the deck.

The extreme height at which the compass may be installed is not regulated, but in any case, it shall not exceed the height providing for the most convenient operation of the compass.

**5.2.10** Standard compasses shall be fitted with bearing finders which shall be capable of taking bearing of all visible objects and heavenly bodies with reading accuracy of  $\pm 0,25^\circ$ .

Bearing finders of new type shall be capable of direct reading of bearings.

**5.2.11** The magnetic compass card or projection tube periscope shall be capable of ensuring accurate indication of readings at a distance of not less than 1,4 m both at day and artificial lighting. The use of magnifying devices is permitted.

**5.2.12** Magnetic compass with electric remote transmission of dial readings shall comply with the requirements of 5.2.1 to 5.2.10. Besides, it shall be capable transmitting the information on the ship's course to other navigational equipment and of indicating the ship's course on the repeaters.

Magnetic system of the standard magnetic compass or special magnetic sensitive elements may be used to serve as a sensitive element of the magnetic compass with electric remote transmission of dial readings.

**5.2.13** Transmitting heading device may consist of:

**.1** a magnetic compass which does not require a power supply source to operate its sensitive element and is provided with an electronic device to take the corrected magnetic course readings and transmit same to other navigational equipment. When provision is made for additional optical transmission of the card dial image to the ship's main workstation

such compass may serve as a standard steering magnetic compass;

**.2** an electromagnetic compass which requires a power supply source to operate its special sensitive element and is provided with an electronic device to generate appropriate signals and to transmit them to other navigational equipment.

**5.2.14** Where the magnetic system of the standard magnetic compass is used as a sensing part for remote transmission of readings, the device intended for electric transmission of readings to repeaters and the transmitting heading device shall be so designed that their arrangement and operation will in no way affect taking bearings, indication of course and bearing of the compass card as well as the work for compensation of deviation.

**5.2.15** The device for remote transmission of course shall incorporate a device for compensation of deviation, including the inclination deviation, within the following limits:

**.1** the vertical component of the ship magnetic field (including the inclination deviation): up to  $\pm 75 \mu\text{T}$ ;

**.2** coefficient *A*: up to  $\pm 3^\circ$ ;

**.3** coefficient *B*: up to  $\pm (720/H)^\circ$ ;

**.4** coefficient *C*: up to  $\pm (720/H)^\circ$ ;

**.5** coefficient *D*: up to  $\pm 7^\circ$ ;

**.6** coefficient *E*: up to  $\pm 3^\circ$ ,

where *H* is the horizontal component of induction vector of the magnetic field at the point compass installation.

The set positions of controllers of the electronic devices for compensation of deviation shall be clearly marked and activated upon switching on the compass.

The device for compensation of deviation shall be protected against unauthorized access.

Provision shall be made for indication of deviation and variation values indispensable for calculation of the total compass correction. The said values shall be displayed directly or accounted for in the output.

All the displayed and output data on the course generated by the device for remote transmission of course shall be automatically converted into the true course of the ship. At least one output channel shall ensure transmission of course to other navigational equipment in accordance with the requirements of 5.1.31.

**5.2.16** The sensitive element impulser and the whole electric remote transmission system of the magnetic compass dial readings shall remain capable of normally operating under the following variations of ship's movement:

circulation with angular speed up to  $6^\circ/\text{s}$ ;

yawing with period 10 to 20 s and maximum course deviation  $\pm 5^\circ$ .

Transmitting heading device with the horizontal component of the Earth magnetic field being  $18 \mu\text{T}$  and under environmental conditions existing on board, shall ensure the following characteristics:

**.1** the static error of course readings shall not exceed  $\pm 1^\circ$ ;

**.2** the dynamic error of course readings and output data under various sea state and ship motions conditions is not to exceed the above-mentioned static error by  $\pm 1,5^\circ$ . The periods of dynamic error variation shall not exceed time intervals of 30 s;

**.3** the lag error of the follow-up system caused by turning of the ship shall not exceed:

0,5°, at an angular turning speed up to 10 °/s;

1,5°, at an angular turning speed from 10 °/s up to 20 °/s.

**5.2.17** Divergence between the readings of repeaters and those of the sensitive element of the magnetic compass fitted with remote transmission of dial readings shall not exceed  $1^\circ$ .

**5.2.18** The accuracy of readings of the standard compass and the operating repeaters shall not be affected by failure or switching-off of separate repeaters.

**5.2.19** Audible signalling system shall be provided to indicate any failure in the follow-up system of the magnetic compass fitted with electric remote transmission of dial readings. The audible signalling system shall be supplied with power from an independent source of energy.

**5.2.20** A special lighted panel "Repeaters are switched to magnetic compass" shall be included into a complete set of the magnetic compass fitted with remote electric transmission of readings (see 3.7.2.10).

**5.2.21** The design of the magnetic compass fitted with optical remote transmission of dial readings shall provide for the screen to present the direct reflected image of the card dial sector with clearly visible divisions of degrees on the arc of not less than  $30^\circ$  as well as the lubber's line fitted in the casing of the compass bowl.

It is recommended that a device capable of presenting the card dial image from fore and aft sides of the periscope shall be provided.

**5.2.22** The length of the projection tube periscope of the magnetic compass fitted with optical remote transmission of dial readings shall provide for the possibility of fitting the screen at eye-level of the helmsman, the height of the compass pad and passage of the periscope tube through the deck being taken into account.

The height of the screen shall be capable of being regulated by 100 to 150 mm up and down from the mean position.

**5.2.23** The screen shall be provided with a device protecting it from bright sunshine or other source of

light capable of distorting the image on the compass card screen by floodlighting. The image shall be distinctly visible on the screen by day and by night.

**5.2.24** The design of the optical system shall provide for the image of the dial sector to remain distinct and clear both during visual bearing taking and with the compass cap closed.

**5.2.25** A suitable device for adjusting and fixing of screen position to facilitate read-out shall be provided.

**5.2.26** The enclosure of optical system shall be of waterproof IP56 design. Adequate measures shall be taken to prevent sweating and condensation of moisture in the enclosure. The easy access shall be provided to optics for the purpose of cleaning.

**5.2.27** The lifeboat magnetic compass shall comply with the following requirements:

**.1** graduation division of compass card shall be  $1^\circ$ ,  $2^\circ$  but shall not exceed  $5^\circ$ , depending on the diameter of the compass card;

**.2** under conditions specified in 5.2.3, the compass card stagnation shall not exceed  $(9/H)^\circ$ ;

**.3** provision shall be made for lighting of the compass card in accordance with the requirements of 5.4.1.5, Part II "Life-Saving Appliances";

**.4** fastening gear for securing the compass in the lifeboat and a box for storing the compass shall be provided;

**.5** the diameter of the compass card shall be sufficient to provide normal taking of readings.

### 5.3 GYROCOMPASS

**5.3.1** The gyrocompass positioned on a horizontal and stationary base in latitudes of up to  $60^\circ$  shall conform to the following requirements:

**.1** the gyrocompass shall be brought into alignment with meridian within 6 h;

**.2** the steady state error at any course shall not exceed  $\pm 0,75^\circ \times \secant \text{ latitude}$  and the root mean square value of the differences between individual course indications and the mean shall be less than  $0,25^\circ \times \secant \text{ latitude}$ ;

**.3** the permissible error from one run-up to another shall be within  $\pm 0,25^\circ \times \secant \text{ latitude}$ ;

**.4** follow-up system performance speed shall be not less than  $6^\circ/\text{s}$ .

**5.3.2** The gyrocompass mounted on board ship under operational conditions in latitudes up to  $60^\circ$  shall conform to the following requirements:

**.1** under rolling and pitching harmonic motions of up to  $5^\circ$  with a period of 6 to 15 s at maximum acceleration of  $0,22 \text{ m/s}^2$  the gyrocompass shall be brought into alignment with meridian within 6 h;

**.2** the error of the master compass readings under service conditions, due to variations in ship's power supply parameters and possible alterations of magnetic fields shall not exceed  $\pm 1^\circ \times \secant$  geographical latitude;

**.3** the error of readings due to a rapid alteration of ship's speed of 20 knots shall not exceed  $\pm 2^\circ$ ;

**.4** the error of readings due to a rapid alteration of course of  $180^\circ$  at a speed of up to 20 knots shall not exceed  $\pm 3^\circ$ ;

**.5** the residual error at a straight course (after correction for speed and course and, if necessary, latitude influences) at a steady speed of up to 20 knots shall not exceed  $\pm 0,25^\circ \times \secant$  latitude;

**.6** errors of readings due to rolling up to  $20^\circ$  C, pitching up to  $10^\circ$  and yawing up to  $5^\circ$  with a period 6 to 15 s and the maximum horizontal accelerations not more than  $1 \text{ m/s}^2$  shall not exceed  $1^\circ \times \secant$  latitude;

**.7** the divergence in readings between the master compass and repeaters shall not exceed  $\pm 0,2^\circ$ .

*Note.* The errors specified in 5.3.2.3 to 5.3.2.6 are taken to be the difference between the observed and the settle point heading values.

**5.3.3** The complete set of gyrocompass shall be provided with a course recorder and also a corrector used for correction of compass readings in respect to ship's speed and latitude.

**5.3.4** It is advisable to provide a course recording device (a course recorder), capable of recording ship's course in respect of time with accuracy of  $\pm 1^\circ$  in the complete set of gyrocompass.

**5.3.5** The system of gyrocompass readings remote transfer shall be so designed as to ensure simultaneous operation of gyrocompass repeaters, fitted in other navigational equipment, the course recorder (when it is available), as well as transmission of information on the course to other navigational equipment.

**5.3.6** The design of repeater cards, bearing taking devices, lighting fittings and other arrangements shall be capable of ensuring the indication of course and bearing readings in compliance with the requirements of 5.2.2, 5.2.4, 5.2.8 (except for the requirements as regards the reserve self-contained source of lighting, kind of electric current and voltage), 5.2.9 and 5.2.10.

#### 5.4 LOG

**5.4.1** Devices to indicate speed and distance (log) are intended for generating and displaying the ship's motion parameters data used for general navigation and ship manoeuvring.

As a compulsory parameter, the log shall be capable of measuring the longitudinal speed component of ship's motion forward speed through water or over the ground as well as the distance run in that direction. Additionally, the log may also measure the other components of ship's motion.

A log transmitting information about the ship's speed to a radar plotting aid (EPA, ATA, ARPA) and to the ship's track control system, shall be capable of measuring the ship's speed through the water in the fore direction.

**5.4.2** The log shall normally function at forward speeds up to the maximum and in water beneath the keel of depth greater than the following values:

3 m for speed and distance measuring devices through the water;

2 m for speed and distance measuring devices over the ground.

**5.4.3** Initial sensitivity of a log shall not be more than 0,1 knot.

**5.4.4** Provided the ship is operating free from shallow effect and from the effects of wind, current and tides, in measuring the ship speed by the log, the error shall not exceed, at normal probability law, the following values:

$\pm 2\%$  of the actual speed of the ship, or  $\pm 0,2$  knots, whichever is greater, for a digital display and for output data transmission;

$\pm 2,5$  per cent of the actual speed of the ship, or  $\pm 0,25$  knots, whichever is greater, for an analogue display.

**5.4.5** In measuring the distance run through the water, the error shall not exceed  $\pm 2$  per cent of the actual distance run by the ship in one hour or  $\pm 0,2$  nautical miles in each hour, whichever is greater, provided the ship is operating free from shallow effect and from the effects of wind, current and tides.

**5.4.6** The divergence in readings of speed repeaters and the main unit shall not exceed  $\pm 1,5$  per cent of the upper limit of the measuring range of the log.

The divergence in readings of distance repeaters and the main unit shall not exceed  $\pm 0,01$  of a mile and that of repeaters,  $\pm 0,02$  of a mile.

The distance repeaters and speed repeaters shall be capable of operating simultaneously.

Speed repeaters shall be of self-synchronized type. It is permitted to use digital display as speed repeaters. In this case, the direction of ship's movement shall be indicated unambiguously.

**5.4.7** The logs shall comply with the following design requirements:

**.1** the submerged retractable mechanism of logs shall provide for their quick setting in operation position and retracting inside the ship's hull by one person only;



**.2** log components structure shall be so designed that neither the method of their attachment to the ship's hull, nor the preventive inspection and replacement on the ship afloat, nor damage to any part of the equipment penetrating the hull could result in the disturbance of the longitudinal strength of the ship's hull and in the ingress of water to the ship;

**.3** where the mass of the retractable submerged mechanism exceeds 16 kg, a mechanical gear (winches, tackles, blocks) for lifting the movable parts inside the hull shall be provided. The time required for retracting shall not exceed 2 min.

Provision shall be made for a device for remote setting in operation position and retracting inside the hull of the submerged part of the log, the device being operated from the wheelhouse. In this case, adequate limit switches capable of restricting the lowering and retracting of the sliding tube, sealing in the sluice valves and a visual signal in the wheelhouse indicating the "lifted" or "lowered" position of the sliding tube as well as "sluice valve closed", if this is required by the design of the log, shall be provided;

**.4** materials used for making the submerged parts of logs, their finishing and coating shall ensure long-time operation of the log in sea water;

**.5** provision shall be made in the complete set of a log for a necessary number of speed and distance repeaters as required by 3.7.3.6 and 3.7.3.7.

The distance and speed repeaters may be incorporated in one common casing;

**.6** logs shall be fitted with devices for adequate adjustments after the installation of these logs on board, as well as for the compensation of the inadmissible errors in log readings;

**.7** speed information may be presented in analogue or digital form, or in both forms at the same time.

Where a digital is used, its incremental steps shall not exceed 0,1 knots at data renewal frequency once per second.

An analogue display shall be graduated at least every 0,5 knots and be marked with figures no greater than every 5 knots.

If the display is intended to present the ship's motion different components, the direction of movement shall be indicated unambiguously;

**.8** distance run information shall be presented in the digital form. The display shall cover the range from 0 to not less than 9999,9 nautical miles and the incremental steps shall not exceed 0,1 nautical miles. On-line counter may be provided for resetting a read out to zero;

**.9** the graduation dials of the main unit and repeaters shall be provided with interior adjustable lighting.

The display shall be easily readable by day and night;

**.10** the interconnection of the repeaters shall be effected through appropriate fuses;

**.11** it is recommended to provide logs with a signalling system capable of monitoring running by the ship of certain predetermined distances;

**.12** it is permitted to use the transducers of logs both of sliding and fixed design.

Sliding and fixed transducers may protrude from the bottom or may be in flush position to the bottom of the ship;

**.13** two primary electromagnetic transducers with appropriate changing-over device are permitted to be installed.

**5.4.8** The log translating device shall provide feeding distance run information to other equipment fitted on board. In this regard if the relay contact is used, the information shall be fed to external systems only for forward ship's movement. The information shall be in the form of one contact closure (or its electrical equivalent) for each 0,005 nautical miles run. The minimum time of contact closure or duration of the equivalent impulse signal shall be at least 50 ms.

If the log is intended for feeding external systems with the information on speed, distance run and also on other ship's movement parameters, including directions, its translating device shall be provided with sufficient number of serial digital interfaces (also refer to 5.1.31).

**5.4.9** If the log is capable of being operated in the speed through water and speed over the ground modes, mode selection and mode indication shall be provided.

If the two-component log has provision for indicating the longitudinal and transverse speed components, the unambiguous and clear indication of the operation mode and displayed parameters shall be provided.

As an additional option, the log display may provide information on the resultant speed vector (as to module and direction) of ship's movement at the place of a transducer location and also the calculated data of bow and stern motion parameters.

**5.4.10** The primary electromagnetic transducers of the logs shall not produce interference to operation of other navigational equipment of the ship.

**5.4.11** The log performance shall not deteriorate when the ship is rolling up to  $\pm 10^\circ$  and pitching up to  $\pm 5^\circ$ .

**5.4.12** If the log performance is affected by certain conditions (sea state and its effects, water temperature, water salinity and aeration, sound velocity in water, the depth of water under the keel, heel, trim and draught of ship), details of possible effects shall be included in the ship's technical documentation.

## 5.5 ECHO SOUNDER

**5.5.1** The echo sounder is intended for reliable measuring, visual presentation, recording and transmitting information on the depth of water under a ship to other ship's systems. The echo sounder shall function at all headway ship speeds from 0 up to 30 knots under conditions of heavy water aeration, of brash, broken ice and in areas with a sharp change of the bottom contour, with the rocky, sandy and muddy bottom.

**5.5.2** The echo sounder shall be capable of measuring any clearance under the transducer between 1 m and 200 m.

**5.5.3** The echo sounder shall be provided with:

**.1** shallow range scale covering 0,1 of the depth range (1 to 20 m);

**.2** deep range scale covering the whole depth range (1 to 200 m).

The pulse repetition rate shall not be slower than 36 pulses per minute on the shallow range and 12 pulses per minute on the deep range.

**5.5.4** Based on a sound speed in water of  $C=1500$  m/s, the tolerance of the indicated depth shall not exceed:

**.1**  $\pm 0,5$  m on the shallow range scale or  $\pm 2,5$  per cent of the indicated depth, whichever is greater;

**.2**  $\pm 5,0$  m on the deep range scale or  $\pm 2,5$  per cent of the indicated depth, whichever is greater.

The echo sounder performance shall not deteriorate when the ship is rolling  $\pm 10^\circ$  and pitching  $\pm 5^\circ$ .

Some omissions in readings are permissible when the ship is rolling more than  $10^\circ$  and/or pitching more than  $5^\circ$ , the sea bed has rocky or steeply sloping character (over  $15^\circ$ ).

**5.5.5** The complete set of the echo sounder shall include one or more transducers, the main unit with built-in depth indicator, a depth recording device, remote repeaters and also the translating device for data transmitting to other ship's systems.

The echo sounder design shall provide for a possibility of displaying the immediate depth on the depth indicator and of recording the sounded depth in the depth recording device.

The depth recording device may be built into the echo sounder main unit.

**5.5.6** More than one transducer fitted in different parts of the ship may be used in the echo sounder composition. In doing so, a clear indication of the transducer(s) in use shall be provided.

**5.5.7** The echo sounder design shall simultaneously provide the presentation of depth information:

**.1** in the graphical form displaying the depth profile along the ship's run;

**.2** in the digital form displaying the immediate depth.

The graphical form of depth information display shall provide a visible record of soundings during at least 15 min.

**5.5.8** The scale of depth display in a graphical form shall be not smaller than:

**.1** 1 m: 5,0 mm per metre depth on the shallow range scale;

**.2** 1 m: 0,5 mm per metre depth on the deep range scale.

The graphical display shall be capable of automatic showing time marks at intervals not exceeding 5 min, and depth marks at intervals not larger than one-tenth of the range of a scale in use.

The indications of digital depth indicators shall be multiples to 0,1 m.

Other forms of depth information display may be used if they do not affect the reliability of graphical and digital information.

**5.5.9** The echo sounder shall be provided with audible and visual alarm signals on ship's approach to the pre-set depth. Manual setting of the pre-set depth in the depth range from 1 m up to 100 m shall be continuous or in steps (5, 50, 100 m).

**5.5.10** The echo sounder shall be provided with a device to allow a correction for determination of a depth under the most immersed part of the ship.

**5.5.11** The echo sounder shall be provided with audible and visual alarms to indicate failures, affecting a reliability of information displayed, and also an interruption of power supply and the critical change of ship's mains parameters.

**5.5.12** The echo sounder depth recording device shall provide recording of information about depth with time marks during previous 12 h. Moreover there shall be means for the shore-based retrieval of recorded information.

**5.5.13** Recording of echo sounder indications may be carried out on the paper tape or other media.

If paper tape is used, the relevant marks shall be provided on its right side indicating when the paper remaining is less than 1 m.

**5.5.14** Switching on of the echo sounder shall be effected by one manipulation.

The starting period shall not exceed 30 s.

**5.5.15** Sounding in shoal water may be effected by an individual echo sounder installed on board the ship which is capable of measuring on the shoal water range scale and not less than on the half of the shallow water range scale.

## 5.6 RATE-OF-TURN INDICATORS

**5.6.1** The rate-of-turn indicator shall operate independently of gyrocompass and radar operation and shall be capable of indicating the direction and angular speed of the ships turn.

**5.6.2** The rate-of-turn indicator shall be so constructed as to operate both with the automatic and manual ship steering.

**5.6.3** With due regard for the influence of earth rate the indicated rate of turn shall not deviate from the actual rate of turn of the ship by more than  $0,5^\circ/\text{min} + 5$  per cent of measured value.

The rate-of-turn indicator shall meet these accuracy requirements at ship's speed up to 10 knots.

**5.6.4** Yawing of the ship at sea shall not change reliable operation of the rate-of-turn indicator on waves.

Periodic rolling motion of the ship with an amplitude of  $\pm 5^\circ$  and period of up to 25 s and periodic pitching motion with an amplitude of  $\pm 1^\circ$  and period of up to 20 s shall not change the mean value of the indicated rate of turn by more than  $0,5^\circ/\text{min}$ .

**5.6.5** The rate-of-turn indicator shall be ready for operation and shall meet the requirements of the present Chapter within 4 min of being switched on. Its operation shall be indicated on the display.

**5.6.6** The number of repeaters of the rate-of-turn indicator shall meet the requirements of 3.7.5.2.

**5.6.7** The rate of turn shall be indicated by a centre-zero analogue type indicator (preferably circular). Where a circular scale indicator is used, the zero shall be uppermost. Alphanumeric display may be permitted. In this case, positive indication of port and starboard shall be provided.

**5.6.8** A turn of ship to port shall be indicated on the left of the zero point and a starboard turn to the right of the zero point. If the actual rate of turn exceeds full scale deflection, this shall be clearly indicated on the display.

**5.6.9** The length of scale in either direction from zero shall not be less than 120 mm. The sensitivity of the system shall ensure that a change in the rate of turn of  $1^\circ/\text{min}$  is represented by a distance of not less than 4 mm on its scale.

**5.6.10** A linear range scale of not less than  $\pm 30^\circ/\text{min}$  shall be provided. This scale shall be marked in intervals of  $1^\circ/\text{min}$  on both sides of zero and with figures every  $10^\circ/\text{min}$ . Every  $10^\circ/\text{min}$  mark shall be significantly longer than the  $5^\circ/\text{min}$  mark which in turn shall be significantly longer than the  $1^\circ/\text{min}$  mark. The marks and figures shall preferably be red or light colour on a dark background. Additional linear range scales may be provided.

**5.6.11** Damping of the rate-of-turn indicator shall be provided with a time constant which may

be varied during operation in the range zero to at least 10 s.

## 5.7 RADAR

**5.7.1** The radar equipment shall assist in avoiding collision and safe navigation by providing a detection and indication of the positions of other ships, shoreline, buoys, surface objects and obstructions as well as navigation marks.

The radar shall perform the following functions:

display of radar video;

indication of position and target tracking information;

positional data derived from own ship's position (EPFS);

display of AIS target information.

It is recommended to provide the capability of displaying data of system Electronic Navigation Charts for monitoring own ship's position.

**5.7.2** Regardless of the type of ship on which the radar will be installed, frequency band used and indication device type the radar shall meet the requirements specified in Table 5.7.2.

Table 5.7.2

| Gross tonnage of ship                         | < 500     | 500 up to < 10000 | $\geq 10000$ |
|---|-----------|-------------------|--------------|
| Minimum operational display area diameter, mm | 180       | 250               | 320          |
| Minimum display area                          | 195 × 195 | 270 × 270         | 340 × 340    |
| Auto acquisition of targets                   | —         | —                 | +            |
| Minimum acquired radar target capacity        | 20        | 30                | 40           |
| Minimum activated AIS target capacity         | 20        | 30                | 40           |
| Minimum sleeping AIS target capacity          | 100       | 150               | 200          |
| Trial Manoeuvre                               | —         | —                 | +            |

**5.7.3** The radar shall ensure operation in the following frequency bands:

X-band: 9,2 to 9,5 GHz (wave length of 3 cm) for high discrimination, good sensitivity with no clutter;

S-band: 2,9 to 3,1 GHz (wave length of 10 cm) to ensure that target detection and tracking capabilities are maintained in adverse conditions of fog, rain and sea clutter.

The frequency band in use shall be clearly indicated.

**5.7.4** The radar shall be capable of operating satisfactorily in typical interference conditions and of measuring the following parameters:

range within 30 m or 1 % of the range scale in use, whichever is greater;

bearing within  $1^\circ$ .

**5.7.5** The capability of the radar of indicating the target in at least 8 out of 10 scans with a probability of radar detection false alarm not more than  $10^{-4}$  shall be determined in the process of the aerial operation within "X-band" (3 cm) and "S-band" (10 cm) under the following conditions:

- absence of clutter;
- aerial height of 15 m above sea level.

The minimum detection ranges for various targets in clutter-free conditions are specified in Table 5.7.5. Minimum range target detection shall be achieved with the use of a regular aerial having the smallest aperture.

**5.7.6** With own ship at the zero speed, absence of clutter, in calm conditions, an aerial height of 15 m above sea level the navigation buoy specified in Table 5.7.5 shall be detected at a minimum horizontal range of 40 m from the aerial position and up to a range of 1 NM, without the setting of control functions other than the range scale selector.

Compensation for any range error shall be automatically applied for each selected aerial, where multiple aeriels are installed.

**5.7.7** The radar shall provide consistent target detection performance on all the working range scales under sleeping clutter conditions.

The radar system shall provide the means to enhance the visibility of targets in adverse sleeping clutter conditions at close range.

Degradation of detection performance (related to the figures in Table 5.7.5) under the following conditions, shall be clearly stated in the technical documentation;

light rain (4 mm per hour) and heavy rain (16 mm per hour);

sea state 2 and sea state 5;  
and a combination of these.

Possible degradation in performance due to a long transmission line, actual aerial height or any other factors shall be clearly stated in the technical documentation.

**5.7.8** Means shall be provided in the radar design for the adequate reduction of unwanted echoes, including sea clutter, rain and other forms of precipitation, clouds, sandstorms and interference from other radars.

Effective manual and automatic anti-clutter functions shall be provided.

A combination of automatic and manual anti-clutter functions is permitted.

A gain control function shall be provided to set smoothly the system gain and signal threshold level.

There shall be clear indication on the radar display of the level for gain and all anti-clutter functions.

**5.7.9** Means shall be available in the radar design to enhance target presentation on the display.

The picture shall be updated in smooth and continuous manner with minimum latency.

The technical documentation shall explain the basic concept, features and limitations of any signal processing.

**5.7.10** The X-band radar system shall be capable of detecting radar beacons, SARTs in the relevant frequency band.

It shall be possible to switch off those signal processing functions, including polarization modes, which may prevent a X-band radar beacon or SART from being detected.

The status of the signal processing mode used shall be indicated.

Table 5.7.5

Minimum detection ranges

| Target description <sup>1</sup>                                 | Target feature, height above sea level, m | Detection range in NM <sup>2</sup> |             |
|---|---|------------------------------------|-------------|
|   |   | X-band 3cm                         | S-band 10cm |
| Shorelines  | Rising to 60 m                            | 20                                 | 20          |
| Shorelines  | Rising to 6 m                             | 8                                  | 8           |
| Shorelines  | Rising to 3m                              | 6                                  | 6           |
| Ships of > 5000 gross tonnage                                   | 10  | 11                                 | 11          |
| Ships of > 500 gross tonnage                                    | 5   | 8                                  | 8           |
| Small vessel with radar reflector <sup>3</sup>                  | 4   | 5                                  | 3,7         |
| Navigation buoy with corner reflector <sup>4</sup>              | 3,5                                       | 4,9                                | 3,6         |
| Navigation buoy <sup>5</sup>                                    | 3,5                                       | 4,6                                | 3,0         |
| Small vessel of length 10m with no radar reflector <sup>6</sup> | 2,0                                       | 3,4                                | 3,0         |

<sup>1</sup> Reflectors are taken as point targets, vessels as complex targets and shorelines as distributed targets (typical values for a rocky shoreline, but are dependent on profile).  
<sup>2</sup> Detection ranges may be changed by various factors, including atmospheric conditions, target speed and aspect, target material and target structure.  
<sup>3</sup> The Radar Cross Section (RCS) for the radar reflector shall be: 7,5 m<sup>2</sup> for X-band, 0,5 m<sup>2</sup> for S-band.  
<sup>4</sup> RCS for the corner reflector shall be: 10 m<sup>2</sup> for X-band and 1 m<sup>2</sup> for S-band.  
<sup>5</sup> The navigation buoy shall have RCS of 5 m<sup>2</sup> for X-band and 0,5 m<sup>2</sup> for S-band.  
For the channel markers with an RCS of 1,0 m<sup>2</sup> (X-band) and 0,1 m<sup>2</sup> (S-band) and height of 1 m their detection range shall be of 2,0 and 1,0 NM respectively.  
<sup>6</sup> RCS for 10 m small vessel shall be of 2,5 m<sup>2</sup> for X-band and 1,4 m<sup>2</sup> for S-band.

**5.7.11** Range and bearing discrimination shall be measured in calm conditions, on the range scale of 1,5 NM or less and at between 50 per cent and 100 per cent of the range scale selected. In so doing the following requirements shall be met:

the radar system shall be capable of displaying two point targets on the same bearing, separated by 40 m or more in range, as two distinct objects;

the radar system shall be capable of displaying two point targets at the same range, separated by 2,5° in bearing, as two distinct objects.

**5.7.12** The target detection performance of equipment shall not be impaired when own ship is rolling or pitching up to  $\pm 10^\circ$ .

**5.7.13** Means shall be available in the radar to monitor performance of the radar system. In the absence of targets, the possibility of monitoring the performance of the radar system shall be retained.

Where applicable to radar technology, manual tuning shall be provided and, additionally, automatic tuning may be provided.

Means shall be available in the radar to determine a significant drop in system performance relative to a calibrated standard established at the time of installation.

**5.7.14** The radar equipment shall be fully operational (RUN status) within 4 min after switch on from cold.

A STANDBY condition shall be provided, in which there is no operational radar transmission. The radar shall be fully operational within 5 sec from the standby condition.

**5.7.15** Measurements from own ship (e. g. target range, variable range markers, target bearing, cursor, tracking data) shall be made with respect to the consistent common reference point of the own ship (e. g. conning position). Facilities shall be provided to compensate for the offset between the aerial position and the consistent common reference point on installation.

Where multiple aerials are installed, there shall be provision for applying different position offsets for each aerial in the radar system. The offsets shall be applied automatically.

Own ship's scaled outline shall be available on lower range scales. The consistent common reference point and the position of the selected radar aerial from which information is derived shall be indicated on this graphic.

Picture on the radar display shall be centred with respect to the consistent common reference point which shall be at the centre of the bearing scale.

Range measurements shall be in nautical miles. In addition, facilities for metric measurements may be provided on lower range scales. All indicated values for range measurement shall be unambiguous.

Radar targets shall be displayed on a linear range scale and without delay in the display when the target position changes.

**5.7.16** Range scales of 0,25; 0,5; 0,75; 1,5; 3; 6; 12 and 24 NM shall be provided. Additional range scales, including large-sized metric range scales, are permitted outside the mandatory set.

The range scale selected shall be permanently indicated.

**5.7.17** An appropriate number of equally spaced fixed range rings shall be indicated on the radar display. The interval between the fixed range rings shall be continuously presented on the radar display.

The system accuracy of fixed range rings shall be within 1 per cent of the maximum range of the range scale in use or 30 m, whichever is the greater distance.

**5.7.18** At least two variable range markers shall be provided, each variable range marker shall have a numerical readout. The variable range marker shall enable the user to measure the range of an object with maximum system error of 1 % of the range scale in use or 30 m, whichever is the greater distance.

**5.7.19** A bearing scale around the periphery of the operational display area shall be provided. The bearing scale shall indicate the bearing as seen from the consistent common reference point of the own ship.

The bearing scale shall be numbered at least every 30 division and have division marks of 5 and 10 which shall be clearly distinguishable from each other. 1 division marks may be presented where they are clearly distinguishable from each other.

**5.7.20** An electronic graphic line from the consistent common reference point to the bearing scale shall indicate the heading of the ship. Means shall be provided to align the electronic heading line to within 0,1.

If there is more than one radar aerial, the heading skew (bearing offset) shall be retained and automatically applied when each radar aerial is selected.

Provision shall be made to temporarily suppress the image of the heading line by the use of a switch with automatic reset to "on" position. This function may be combined with the suppression of other graphics.

**5.7.21** At least two electronic bearing lines (EBLs) shall be provided to measure the bearing of any point object with a maximum system error of 1 at the periphery of the display.

The EBLs shall be capable of measurement relative to ship's heading and relative to true north. There shall be a clear indication of the bearing reference (i.e. true or relative).

It shall be possible to move the EBL origin from the consistent common reference point to any point of the operational display area and to reset the EBL to the consistent common reference point by a fast and simple action.

It shall be possible to fix the EBL origin at any point of the display or to move the EBL origin at the velocity of own ship.

Means shall be provided to ensure that the user is able to position the EBL smoothly in either direction and to maintain the appropriate system measurement accuracy requirements.

Each EBL shall have a numerical readout with a resolution adequate to maintain the system measurement accuracy requirements.

**5.7.22** A minimum of four independent parallel index lines, with a means to truncate and switch off each individual line shall be provided.

Means of setting the bearing and beam range of the parallel index lines shall be provided.

**5.7.23** There shall be a means to measure the range and bearing of one position on the display relative to any other position on the operational display area.

**5.7.24** A user cursor shall be provided to enable designation of any position on the operational display area. The cursor position shall have a continuous readout to provide the range and bearing, measured from the consistent common reference point, and/or the latitude and longitude of the cursor position presented either alternatively or simultaneously.

The cursor shall provide a means to select and de-select targets, graphics within the operational display area. In addition, the cursor may be used to select modes, functions, vary parameters and control menus outside the operational display area.

Means shall be provided to easily locate the cursor position on the display.

The accuracy of the range and bearing measurements provided by the cursor shall meet the relevant requirements for VRM and EBL.

**5.7.25** The own ship's heading information shall be provided by a gyrocompass.

The accuracy of azimuth alignment of the radar presentation shall be within 0,5 with a rate of turn likely to be experienced with the class of ship.

The own ship's heading information shall be referenced to the consistent common reference point and displayed with a numerical resolution to permit accurate alignment with the gyro system.

**5.7.26** A True Motion display mode shall be provided having regard to the motion parameters of the own ship. The automatic reset of own ship may be initiated by its position on the display, or time related, or both.

The reset shall be selected to occur at least on every scan.

North Up and Course Up orientation modes shall be provided.

A clear and continuous indication of the motion and orientation mode shall be provided.

**5.7.27** Manual off-centring shall be provided to locate the selected aerial position at any point within at least 0,5 of the radius from the centre of the operational display area.

On selection of off-centred display, the selected aerial position shall be capable of being located to any point on the display within 0,75 of the radius from the centre of the operational display area.

In True Motion, the selected aerial position shall automatically reset to a location giving the maximum view along own ship's course. Provision for an early reset of selected aerial position shall be provided.

**5.7.28** Two modes of display and graphics stabilization: ground and sea stabilization modes shall be provided.

The stabilization mode in use and information on information sensor enabling implementation of the selected mode shall be clearly indicated.

**5.7.29** Variable length (time) target trails (after-glow) shall be provided with an indication of trail time and mode.

It shall be possible to select true or relative trails.

The trails shall be distinguishable from targets.

Either scaled trails or past positions or both, shall be maintained and available for presentation within 2 scans, following:

the reduction of increase of one range scale;

the offset and reset of the radar picture position;

and

a change between true and relative trails.

**5.7.30** Targets shall be presented in accordance with relevant symbols according to the requirements of 5.7.58.

The target information may be provided by the radar tracking function and by the reported target information from the AIS.

The number of targets present shall be as defined in Table 5.7.2.

A warning alarm shall be automatically actuated when the target number (radar tracked or AIS reported targets) is about to be maximum.

As far as practical, the data format for operating and displaying the radar and AIS targets shall be consistent.

**5.7.31** Radar targets shall be provided by the radar transceiver. The signals shall be filtered with the aid of the associated clutter controls. Radar targets may be automatically or manually acquired and tracked using an automatic target tracking facility.

The automatic target tracking calculations shall be based on the measurement of radar target relative position and own ship motion.

Any other sources of information, when available, may be used to support the optimum tracking performance.

Target tracking facilities shall be available on at least the 3, 6 and 12 NM range scales. Tracking range shall extend to a minimum 12 NM.

The radar system shall be capable of tracking targets having the relative speed equivalent to those at which sea-going ships including high-speed craft can operate.

**5.7.32** In addition to the requirements for processing of targets reported by AIS, it shall be possible to provide presentation for a number of radar targets according to Table 5.7.2. When the established target tracking capacity is about to be exceeded, target overflow shall not degrade the radar system performance.

**5.7.33** Manual and automatic acquisition of radar targets shall be provided with provision for acquiring the number of targets specified in Table 5.7.2. There shall be means for the user to define the boundaries of the auto-acquisition area.

**5.7.34** When a target is acquired, the system shall present the trend of the target's motion within one minute and the prediction of the target's motion within 3 minutes.

The target tracking system shall be capable of updating the information of all acquired targets automatically and shall continue to track radar targets that are clearly distinguishable on the display for 5 out of 10 consecutive scans.

The target tracking system design shall be such that smoothed target vector is calculated, while target manoeuvres shall be detected as early as possible.

The possibility of tracking errors, including target swap, shall be minimized.

Separate facilities for cancelling the tracking of any one and of all targets shall be provided.

The greatest possible automatic tracking accuracy shall be achieved when the tracked target has achieved a steady state and with the required accuracy performance of the information sensor.

For ships capable of up to and including 30 kn true speed, the tracking facility shall present, within 1 min steady state tracking, the relative motion trend and after 3 min, the predicted motion of a target, within the accuracy values specified in Table 5.7.34.

Accuracy may be significantly reduced under the following conditions:

- shortly after acquisition;
- own ship manoeuvre;
- a manoeuvre of the target;
- any tracking disturbance;
- sensor accuracy.

Measured target range and bearing shall be within:  
50 m (by range) (or 1 per cent of target range);  
2° (by bearing).

For ships capable of speeds in excess of 30 kn and with speeds of up to 70 kn, the motion accuracy values

Table 5.7.34  
Tracked Target Accuracy (95 per cent probability figures)

| Time of steady state (min) | Relative course (deg) | Relative speed (kn)                | $D_{ap}$ (NM) | Tap (min) | True course (deg) | True speed (kn)                   |
|----------------------------|-----------------------|------------------------------------|---------------|-----------|-------------------|-----------------------------------|
| 1 min: Trend               | 11                    | 1,5 or 10 % (whichever is greater) | 1             | —         | —                 | —                                 |
| 3 min: Motion              | 3                     | 0,8 or 1 % (whichever is greater)  | 0,3           | 0,5       | 5                 | 0,5 or 1 % (whichever is greater) |

specified in Table 5.7.34 shall be maintained with target relative speeds of up to and including 140 kn.

A ground referencing function, based of a stationary tracked target, shall be provided. Targets used for this function shall be marked with the relevant symbol.

**5.7.35** Reported targets provided by the AIS shall be displayed according to pre-defined parameters. Targets may be sleeping, or may be activated.

Activated targets shall be treated in a similar way to radar tracked targets.

There shall be an automatic indication when the capacity of display of AIS targets (sleeping and/or activated) is about to be exceeded.

**5.7.36** To reduce display clutter, a means to filter the presentation of sleeping AIS targets shall be provided, together with an indication of the filter status (e. g. by target range, distance and time to the closest point of approach —  $D_{ap}$ ,  $T_{ap}$ , AIS target class: A, B, etc.). It shall not be possible to remove individual AIS targets from the display.

**5.7.37** A means shall be provided to activate a sleeping AIS target and to deactivate the activated AIS targets.

If zones for the automatic activation of AIS targets are provided, they shall be the same as for automatic radar target acquisition.

In addition to the beginning of activation the AIS targets when entered in the established zone, sleeping AIS targets may be automatically activated when meeting user defined parameters: target range, distance and time to the closest point of approach ( $D_{ap}$ ,  $T_{ap}$ ), AIS target class (A, B).

**5.7.38** The AIS target presentation status shall be in accordance with Table 5.7.38.

**5.7.39** Symbols for presentation of AIS target on the radar display shall be in accordance with the requirements of 5.7.58.

AIS targets that are displayed shall be presented as sleeping targets by default.

The course and speed of a tracked radar target or reported AIS target shall be indicated by a predicted vector of adjustable length.

Table 5.7.38

The AIS presentation status

| Function                          | Cases to be presented  |   | Presentation               |
|-----------------------------------|--|---|----------------------------|
| AIS On/Off                        | AIS processing switched on/<br>graphical presentation switched off | AIS presentation switched on/<br>graphical presentation switched on | Alphanumeric or graphical  |
| Filtering of sleeping AIS targets | Filter status  | Filter status   | Alphanumeric or graphical  |
| Activation of targets             |  | Activation criteria   | Graphical                  |
| $D_{ap}/T_{ap}$ alarm             | Function On/Off<br>Sleeping targets included                       | Function On/Off<br>Sleeping targets included                        | Alphanumeric and graphical |
| Lost target alarm                 | Function On/Off<br>Lost target filter criteria                     | Function On/Off<br>Lost target filter criteria                      | Alphanumeric and graphical |
| Target association                | Function On/Off<br>Association criteria<br>Default target priority | Function On/Off<br>Association criteria<br>Default target priority  | Alphanumeric               |

Permanent and clear indication of vector time and stabilization shall be provided.

The consistent common reference point of own ship shall be used for presentation of radar targets and AIS targets on the radar display.

To present activated targets on close range from the own ship, a means to present the true scale outline of an activated AIS target shall be provided.

It shall be possible to display the past track of activated AIS targets.

**5.7.40** It shall be possible to select any tracked radar or AIS target for alphanumeric display of its data. A target selected for display shall be identified by the relevant symbol. If more than one target is selected for data display, the relevant symbols and the corresponding data shall be clearly indicated. There shall be a clear indication to show that the target data is derived from radar or from AIS.

For each selected target, the following data shall be presented in alphanumeric form:

- source of data (radar or AIS);
- range of target;
- bearing of target;
- COG (course over ground);
- speed over ground;
- $D_{ap}$  and  $T_{ap}$ .

Additionally, for each selected tracked AIS target the following data shall be presented:

- ship's identification;
- navigational status (underway, at anchor, etc.);
- position.

Target heading and reported rate of turn of the AIS target may be also made available.

Additional target information may be provided on request.

If the received AIS information is incomplete, the absent information shall be clearly indicated as "MISSING" within the target data field.

The data on selected target shall be displayed and continually updated, until another target is selected for data display or until the window is closed.

Means shall be provided to present own ship AIS data on request.

**5.7.41** A clear indication of the cause for all alarm criteria shall be given.

If the calculated  $D_{ap}$  and  $T_{ap}$  values of a tracked target or activated AIS target are less than the set limits;

a  $D_{ap}/T_{ap}$  alarm shall be given;

the alarmed target shall be clearly indicated.

The preset  $D_{ap}/T_{ap}$  limits applied to targets from radar and AIS shall be identical. The  $D_{ap}/T_{ap}$  alarm functionality shall be applied for all activated AIS targets.

On request the  $D_{ap}/T_{ap}$  alarm functionality may also be applied to sleeping AIS targets.

When new targets are detected within the defined acquisition zone for automatic tracking and when new AIS targets are activated, these targets shall be clearly identified and an alarm shall be given.

The system shall alert the user if a tracked radar target is lost, rather than excluded by a pre-determined range or pre-set parameter. The last position of the target removed from tracking shall be clearly indicated on the display.

It shall be possible to enable or disable the lost target alarm function for AIS targets. A clear indication shall be given if the target is lost and if the lost target alarm is disabled.

The last position of the lost AIS target shall be clearly indicated on the display.

The indication of the lost target shall disappear if the AIS signal is received again, or after the lost target alarm has been acknowledged. A means of recovering limited historical data from previous AIS reports on lost targets shall be provided.

**5.7.42** If the association criteria are fulfilled such that the radar and AIS reported information are considered as one physical target, than as a default condition, such target shall be displayed by the activated AIS target symbol and alphanumeric AIS target data.

The user shall have the option to change the default condition to display data and shall be permitted to select target data source (radar or AIS).

If the AIS and radar information become sufficiently different, the AIS and radar information



shall be considered as two distinct physical targets and one activated AIS target and one tracked radar target shall be displayed. No alarm shall be raised.

**5.7.43** On ships of 10000 gross tonnage and upwards the radar system shall be capable of simulating the manoeuvre, namely, shall provide a possibility of simulating the approach situations during the manoeuvre with due regard for own ship's dynamic characteristics. A trial manoeuvre simulation shall be clearly identified. The requirements are:

the simulation of own ship course and speed shall be variable;

a simulated time to manoeuvre with a countdown shall be provided;

during simulation, target tracking shall continue and the actual target data shall be indicated;

trial manoeuvre shall be applied to all tracked radar target and all activated AIS targets.

**5.7.44** It shall be possible for the user to manually display sketch maps of the navigation area, various navigation lines, routes referenced to own ship and its geographical position. It shall be possible to remove the display of this data by a simple operator action.

The sketch maps may consist of lines, symbols and reference points, which shall comply with the requirements of 5.7.58.

The displayed additional marks and symbols shall not degrade the radar information. The displayed information shall be retained when the equipment is switched off and restored when a relevant equipment module is replaced.

**5.7.45** The radar system may provide the means to display electronic navigation charts (ENC) to provide real-time sailing conditions monitoring.

The displayed ENC shall comply with International Hydrographic Organization (IHO)'s relevant standards.

It shall be possible to display information derived from ENC updates.

It shall be possible to display ENC by levels or categories of information, but not by individual objects or chart symbols.

The display of ENC shall use the same reference criteria as the AIS, including consistent common reference point of own ship and datum. Scale and orientation of ENC and radar indication shall be identical.

It shall be possible to remove the display of chart data by a single operator action.

The display of radar information shall have priority over all other data which may be displayed. Chart information shall be displayed such that radar information is not obscured or degraded. Chart information shall be clearly perceptible as such.

A malfunction of the source of chart data shall not affect the operation of the radar/AIS system.

**5.7.46** Alarm shall be provided to alert the user of "picture freeze". Failure of any sensor interfaced to the radar, including: gyro, log, aerial position sensor shall be alarmed.

In case of the radar failure, provision shall be made for transfer to the use of accessible standby means or arrangements shall be made to continue the radar operation with some system functionalities being limited in use.

**5.7.47** When multiple radars operate jointly, the system shall safeguard against single point system failure.

When an integrated multiple radar system includes components of the same purpose, provision shall be made for interswitching thereof.

The mode used to receive and process the radar information as well as the operational data on system status shall be indicated at each display position.

**5.7.48** The radar operational controls shall ensure that radar system is simple and convenient to operate.

The radar system shall be capable of being switched "on" or "off" at the main system radar display or at an additional control position.

The radar control functions may be realized as an individual control panel or with the use of a programmed access to control (e. g. on-screen menu) or a combination of these.

The primary control functions shall be dedicated hardware controls or control keyboard, with an associated status indication. The following are defined as primary radar control functions:

- radar standby/run;
- range scale selection;
- gain;
- manual tuning function (if applicable);
- anti-clutter rain;
- anti-clutter sea;
- AIS function on/off;
- alarm acknowledge;
- cursor;
- a means to set EBL;
- a means to set VRM;
- display brightness;
- acquisition of radar targets.

The primary functions shall be operated directly at the main system radar display in addition to the remote control positions.

**5.7.49** The radar system shall include a means to record the total operating hours for any components with a limited life.

Provision shall be made to identify the radar failures.

**5.7.50** Provision shall be made to switch off automatically high-frequency radiation within the pre-set sectors. Indication of these sectors shall be provided.

**5.7.51** The radar aerial shall be designed to operate reliably in wind speeds likely to be encountered on the class of ship on which it is installed.

The rotation rate shall be such as to provide and appropriate information update rate .

There shall be a means to prevent aerial rotation and electromagnetic radiation during servicing, or while personnel are in the vicinity of the aerial or up-mast units.

**5.7.52** The radar design shall ensure that the radar system can be operated by trained users.

A target simulation facility shall be provided for training purposes and for acquiring skills in operation.

**5.7.53** The radar system shall be capable of receiving the required input information (in standard format) from:

- a gyro-compass or transmitting heading device;
- a log;
- radionavigation system receiver;
- AIS equipment;
- other sources of equivalent information.

**5.7.54** Means shall be provided in the radar system to preclude the use of invalid data. If quality and validity of input data are identified as inconsistent with the requirements this shall be clearly indicated.

As far as is practical, the integrity of data coming from external sensors shall be checked. Such check shall be carried out by comparison with other connected sensors or by other accessible checks such as testing to ascertain that the current data do not exceed the allowable data limits.

The latency of processing input data shall be minimized.

**5.7.55** It shall be possible to provide information (in standard format) by any radar output interface to other ship's systems.

The radar system shall provide an output of the display data for the voyage data recorder.

At least one normally closed contact (isolated) shall be provided for indicating failure of the radar.

The radar shall have a bi-directional interface to other systems to facilitate communication so that alarms indicating failure of the radar can be transferred to external systems and so that audible alarms from the radar can be remotely muted from external systems.

**5.7.56** In the event of failure in receiving input data from external information sources maintaining operation of the radar there shall be an appropriate permanent indication. Depending on the nature of failure, the following basic functions shall be performed:

**.1** in the event of failure of information from gyro-compass (transmitting heading device) the radar equipment shall operate satisfactorily in an "unsta-

bilized head-up" mode. The stabilization mode shall be changed automatically within 1 min after a failure in receiving appropriate information from external source.

If automatic anti-clutter sea processing could prevent the detection of targets in the absence of azimuth stabilization, the processing shall switch off automatically within 1 min.

An indication shall be given that only relative bearing measurements can be used;

**.2** in the event of failure of speed through water information a means of manual speed input shall be provided;

**.3** in the event of failure of speed or course and speed over ground information the equipment shall be operated with speed through water information;

**.4** in the event of failure of position input information the electronic navigation chart shall be displayed if only at least a single reference point with known position is used or the position is manually entered;

**.5** in the vent of failure of radar video input information from the radar components ensuring radiation and reception of radar signals, the equipment shall continue to display target information based on AIS data. The last radar picture shall not be displayed;

**.6** in the event of failure of AIS input information, the equipment shall display the radar video and target database;

**.7** in the event of failure of information from other ship's systems interfaced to the radar, the equipment shall be capable of operating equivalent to stand alone system.

**5.7.57** The radar operating instructions shall contain a detailed information on all possible functions, including:

- recommended settings of controls for different weather conditions of radar operation;
- performance of the radar system;
- operator's actions in case of failures;
- limitations of the display and tracking process and accuracy, including any delays in processing and presentation of information;
- using own ship heading and speed over ground/course over ground information for collision avoidance;
- limitations and conditions of target association, separate target presentation;
- criteria of selection for automatic acquisition of AIS targets and cancellation of activation;
- methods applied to display AIS targets and any limitations;
- principles underlying the trial manoeuvre technology, including simulation of own ship's manoeuvring characteristics, if provided;
- alarms and indications;

equipment installation and arrangement requirements;  
 radar range and bearing accuracies;  
 additional functional capabilities and operator's actions (e. g. for detection of SARTs);  
 the value of the consistent common reference point of own ship in the information processing and presentation process;  
 factors affecting the change of radar performance.

The manufacturer's instructions for the radar system installation shall be an integral part of the technical documentation.

**5.7.58** Abbreviations of terms used in displaying the operation modes and other information shall be in accordance with those given in Table 5.7.58-1.

Abbreviations of displayed units shall be in accordance with those given in Table 5.7.58-2.

Symbols used to indicate the radar targets, AIS targets and other marks on the radar display of own ship shall be in accordance with those given in Table 5.7.58-3.

**5.7.59** The radars for ships of river-sea navigation (marks for restricted areas of navigation in the character of classification of a ship are **R2-RSN** and **R3-RSN**) engaged on inland waterways voyages shall, in addition to requirements in 5.1, 5.7.1, 5.7.7 to 5.7.9, 5.7.14 comply with the following requirements.

**5.7.59.1** The display unit of the radar installed on board ship with the aerial height above sea level being equal to 10 m shall be capable of giving clear presentation of various objects within the ranges (in kilometers) given below:

|   |    |
|---|----|
| Shore of height, m:   |    |
| 60 . . . . .  | 37 |
| 6 . . . . .   | 13 |
| Ship of gross tonnage:                                      |    |
| 5000 . . . . .  | 13 |
| 20 . . . . .  | 4  |
| Buoy with reflecting surface of 10 m <sup>2</sup> . . . . . | 4  |

The display of all objects shall remain visible when the ship is rolling or pitching up to  $\pm 10^\circ$ .

**5.7.59.2** Basic performance parameters of the shipboard radar with the aerial height of 7 m above sea level shall not be worse than those specified in Table 5.7.59.2.

The equipment performance shall not deteriorate when the ship is rolling and pitching up to  $\pm 10^\circ$ .

**5.7.59.3** The display shall have an effective diameter of at least:

180 mm for ships from 300 to 1600 gross tonnage;

250 mm for ships from 1600 gross tonnage and over.

The display unit of the radar shall be provided with six range scales from 400 m to 5000 m. In this

regard there shall be indicated not less than four fixed electronic range rings and a variable electronic marker range with a numeric read-out of range in meters (kilometers) on each range scale.

The variable electronic marker range shall enable the range of an object to be measured with an error not more than 10 m on range scales of 0,4 to 2,0 km and 0,8 per cent of the range of the following scale established.

**5.7.59.4** It shall be possible that brightness of the fixed electronic range rings and a variable electronic marker be varied until they are fully removed from the display.

**5.7.59.5** The display unit of the radar shall be fitted with the electronic or mechanical device for taking bearings of the detected objects.

**5.7.59.6** In radar provision be made for clockwise, continuous and automatic scan through 360° of azimuth. The scan rate shall be not less than 18 r.p.m. The aerial shall operate satisfactorily in relative wind speeds up to 50 m/s.

**5.7.59.7** It shall be possible to off-set the radar origin to any display point for a distance of at least 0,5 of the display radius.

**5.7.59.8** The radar display provided with two sets of range scales, in meters (kilometers) and nautical miles, shall have the means of switching-over and the relevant indication of a measurement unit chosen for range measuring.

**5.8 RADAR REFLECTOR**

**5.8.1** The radar reflector (either active or passive) shall have effective echoing area to enable detection by ships navigating by radar at both 9 GHz and 3 GHz bands whose wavelengths are 3 cm and 10 cm respectively.

**5.8.2** The radar reflector shall have the following nominal level of the effective echoing area when mounted at a minimum height of 4 m above water level:

- at least 7,5 m<sup>2</sup> in 9 GHz band;
- 0,5 m<sup>2</sup> in 3 GHz band.

**5.8.3** The nominal minimum level for reflector effective echoing area, as per 5.8.2, shall be maintained over a total of at least 280° azimuth.

**5.8.4** The radar reflector polar diagram shall be such that any single angle with a response below nominal minimum level would not be greater than 10° (zero range), and the distances between the neighboring zero ranges shall be less than 20°.

**5.8.5** For self-propelled ships and sailing vessels designed to operate with little heel and/or trim (catamaran/trimaran), the requirements of 5.8.2 shall

Table 5.7.58-1

## Terms and Their Abbreviations

| Abbreviation | Term used                         |  |
|--------------|-----------------------------------|--|
|              | English                           | Russian  |
| ACK          | Acknowledge                       | Подтверждение                                    |
| ACQ          | Acquire, Acquisition              | Захват   |
| AZ           | Acquisition zone                  | Зона захвата                                     |
| AFT          | Aft                               | Корма  |
| ALARM        | Alarm                             | Тревога  |
| ALT          | Altitude                          | Высота   |
| AM           | Amplitude modulation              | Амплитудная модуляция                            |
| ANCH         | Anchor watch                      | Якорная вахта                                    |
| ANT          | Antenna                           | Антенна  |
| RAIN         | Anti clutter rain                 | Подавление помех от дождя                        |
| SEA          | Anti clutter sea                  | Подавление помех от волнения моря                |
| AUD          | Audible                           | Звуковой   |
| AUTO         | Automatic                         | Автоматическое                                   |
| AFC          | Automatic frequency control       | Автоматическое управление частотой               |
| AGC          | Automatic gain control            | Автоматическое усиление                          |
| AIS          | Automatic Identification System   | Автоматическая идентификационная система         |
| AUX          | Auxiliary system/function         | Дополнительная система / функция                 |
| AVAIL        | Available                         | Доступность                                      |
| BKGND        | Background                        | Обзор  |
| BRG          | Bearing                           | Пеленг   |
| BWW          | Bearing waypoint to waypoint      | Пеленг с путевой точки на другую путевую точку   |
| BRILL        | Brilliance                        | Яркость  |
| CAL          | Calibrate                         | Калибровка                                       |
| CNCL         | Cancel                            | Отмена   |
| CENT         | Centre                            | Центр  |
| CHG          | Change                            | Изменение  |
| CP           | Circular polarized                | Круговая поляризация                             |
| CLR          | Clear                             | Очистка  |
| CPA          | Closest point of approach         | Точка кратчайшего сближения                      |
| CCRS         | Consistent common reference point | Общая опорная точка                              |
| CONT         | Contrast                          | Контраст   |
| CORR         | Correction                        | Корректурa                                       |
| CRS          | Course                            | Путевой угол (курс)                              |
| COG          | Course over the ground            | Путевой угол (курс) относительно грунта          |
| CTW          | Course through the water          | Путевой угол относительно воды (с учетом дрейфа) |
| CTS          | Course to steer                   | Заданный путевой угол                            |
| CUP          | Course up                         | Ориентация по путевому углу                      |
| XTD          | Cross track distance              | Траверзное расстояние                            |
| CURS         | Cursor                            | Курсор   |
| DG           | Dangerous goods                   | Опасные грузы                                    |
| DATE         | Date                              | Дата   |
| DR           | Dead reckoning                    | Счисление пути                                   |
| DECR         | Decrease                          | Уменьшение                                       |
| DEL          | Delete                            | Удалить  |
| DEP          | Departure                         | Отсутствие                                       |
| DPTH         | Depth                             | Глубина  |
| DEST         | Destination                       | Пункт назначения                                 |
| DEV          | Deviation                         | Девиация   |
| DGNSS        | Differential GNSS                 | Дифференциальный режим ГНСС                      |
| DSC          | Digital selective calling         | Цифровой избирательный вызов (ЦИВ)               |
| DISP         | Display                           | Дисплей  |
| DIST         | Distance                          | Расстояние                                       |
| DRMS         | Distance root mean square         | Среднее квадратическое отклонение по расстоянию  |
| DTG          | Distance to go                    | Заданное расстояние                              |
| DRIFT        | Drift                             | Дрейф  |
| E            | East                              | Восток   |
| EBL          | Electronic bearing lane           | Электронная линия пеленга                        |
| EPFS         | Electronic position fixing system | Электронная система определения местоположения   |
| ENH          | Enhance                           | Увеличение заметности                            |
| ERR          | Error                             | Погрешность (ошибка)                             |
| EP           | Estimated position                | Счислимое место с учетом дрейфа                  |
| ETA          | Estimated time of arrival         | Расчетное время прихода                          |
| EVENT        | Event                             | Событие  |

Table 5.7.58-1 — continued

| Abbreviation | Term used                                |   |
|--------------|--|---|
|              | English                                  | Russian   |
| EXT          | External                                 | Внешний   |
| FIX          | Fix                                      | Определение места                                       |
| FM           | Frequency modulation                     | Частотная модуляция                                     |
| FULL         | Full                                     | Полный  |
| GAIN         | Gain                                     | Усиление  |
| GDOP         | Geometric dilution of precision          | Геометрический фактор ухудшения точности                |
| GNSS         | Global navigation satellite system       | Глобальная спутниковая навигационная система            |
| GC           | Great circle                             | Большой круг  |
| GND          | Ground                                   | Поверхность Земли                                       |
| GRI          | Group repetition interval                | Групповой интервал повторения                           |
| GZ           | Guard zone                               | Охранная зона   |
| GYRO         | Gyro                                     | Гироскоп  |
| HS           | Harmful substances                       | Сообщение об опасных грузах                             |
| HUP          | Head up                                  | Ориентация по курсу                                     |
| HDG          | Heading                                  | Курс  |
| HCS          | Heading control system                   | Система управления курсом судна                         |
| HL           | Heading line                             | Линия курса   |
| HF           | High frequency                           | Высокая частота   |
| HSC          | High speed craft (HSC)                   | Высокоскоростное судно (ВСС)                            |
| HDOP         | Horizontal dilution of precision         | Горизонтальный геометрический фактор ухудшения точности |
| ID           | Identification                           | Идентификация   |
| INCR         | Increase                                 | Увеличение  |
| IND          | Indication                               | Индикация   |
| INFO         | Information                              | Информация  |
| INF RED      | Infrared                                 | Инфракрасный  |
| INIT         | Initialization                           | Начало  |
| INP          | Input                                    | Ввод  |
| I/O          | Input/Output                             | Ввод/Вывод  |
| IRCS         | Integrated Radio Communication System    | Интегрированная система радиосвязи                      |
| IR           | Interference rejection                   | Подавление помех  |
| ISW          | Interswitch                              | Переключение  |
| INT          | Interval                                 | Интервал  |
| LAT          | Latitude                                 | Широта  |
| LIM          | Limit                                    | Предел (предельное значение)                            |
| LOP          | Line of position                         | Линия положения   |
| LOG          | Log                                      | Лог   |
| LR           | Long range                               | Большая дальность                                       |
| LON          | Longitude                                | Долгота   |
| LOST TGT     | Lost target                              | Потерянная цель   |
| LF           | Low frequency                            | Низкая частота  |
| MAG          | Magnetic                                 | Магнитный   |
| MVR          | Maneuver                                 | Маневр  |
| MAN          | Manual                                   | Ручное  |
| MAP          | Map                                      | Карта   |
| MAX          | Maximum                                  | Максимум  |
| MMSI         | Maritime mobile services identity number | Идентификационный номер морской подвижной службы        |
| MENU         | Menu                                     | Меню  |
| MP           | Maritime pollutant                       | Загрязнитель морской среды                              |
| MIN          | Minimum                                  | Минимум   |
| MSI          | Maritime safety information              | Информация по безопасности мореплавания                 |
| MKR          | Marker                                   | Маркер  |
| MSTR         | Master                                   | Капитан   |
| MF           | Medium frequency                         | Средние частоты   |
| MISSING      | Missing                                  | Ошибка  |
| MUTE         | Mute                                     | Тишина (без звука)                                      |
| NAV          | Navigation                               | Навигация   |
| N            | North                                    | Север   |
| NORM         | Normal                                   | Нормальный (ое)   |
| N UP         | North up                                 | Ориентация по меридиану                                 |
| OFF          | Off                                      | Выключить (ено)   |
| OOW          | Officer on watch                         | Вахтенный офицер  |
| OFFSET       | Offset                                   | Сдвиг   |
| ON           | On                                       | Включить (ено)  |
| OUT          | Out/Output                               | Ввод/Вывод  |
| OS           | Own ship                                 | Собственное судно                                       |

| Abbreviation | Term used                              |  |
|--------------|--|--|
|              | English                                | Russian  |
| PANEL        | Panel illumination                     | Освещение панели                                       |
| PI           | Parallel index line                    | Линия параллельного индекса                            |
| PASSV        | Passenger vessel                       | Пассажирское судно                                     |
| PERM         | Permanent                              | Постоянно  |
| POB          | Person overboard                       | Человек за бортом                                      |
| PIN          | Personal identification number         | Личный номер члена экипажа                             |
| PILOT        | Pilot vessel                           | Лоцманское судно                                       |
| PORT         | Port/Portside                          | Левый борт   |
| POSN         | Position                               | Координаты   |
| PDOP         | Positional dilution of precision       | Фактор ухудшения точности места                        |
| PWR          | Power                                  | Питание  |
| PRED         | Predicted                              | Прогнозируемое   |
| PPC          | Predicted point of collision           | Расчетная точка столкновения                           |
| PRF          | Pulse repetition frequency             | Частота повторения импульсов                           |
| PPR          | Pulse per revolution                   | Число импульсов на оборот                              |
| RACON        | Racon                                  | Радиолокационный маяк-ответчик                         |
| RADAR        | Radar                                  | Радиолокационная станция                               |
| RAIN         | Rain                                   | Дождь  |
| RGN          | Range                                  | Расстояние (дальность)                                 |
| RR           | Rang rings                             | Кольца дальности                                       |
| RCDS         | Raster chart display system            | Система отображения растровых карт                     |
| RNC          | Raster navigational chart              | Растровая навигационная карта                          |
| ROT          | Rate of turn                           | Угловая скорость поворота                              |
| RX           | Receiver                               | Приемник (приемное устройство)                         |
| RM           | Relative motion                        | Относительное движение                                 |
| RPM          | Revolution per minute                  | Число оборотов в минуту                                |
| RMS          | Root mean square                       | Среднее квадратическое отклонение                      |
| ROUTE        | Route                                  | Путь   |
| S            | South                                  | Юг   |
| SF CNT       | Safety contour                         | Контур безопасности                                    |
| SAIL         | Sailing vessel                         | Парусное судно   |
| SAT          | Satellite                              | Спутник  |
| S – BAND     | S - band                               | Полоса частот – S диапазона                            |
| SARV         | Search and rescue vessel               | Спасательное судно                                     |
| SEL          | Select                                 | Выбор  |
| SEQ          | Sequence                               | Последовательность                                     |
| SET          | Set                                    | Снос   |
| TIME         | Ship's time                            | Судовое время  |
| SP           | Short pulse                            | Короткий импульс                                       |
| SNR          | Signal to noise ratio                  | Отношение сигнал / помеха                              |
| SIM          | Simulation                             | Проигрывание   |
| SPD          | Speed                                  | Скорость   |
| SDME         | Speed and distance measuring equipment | Устройство измерения скорости и пройденного расстояния |
| SOG          | Speed over the ground                  | Скорость относительно грунта                           |
| STW          | Speed through the water                | Скорость относительно воды                             |
| STBY         | Stand-by                               | Готовность   |
| STBD         | Starboard side                         | Правый борт  |
| STN          | Station                                | Станция  |
| SYNC         | Synchronization                        | Синхронизация  |
| TGT          | Target                                 | Цель   |
| TT           | Target tracking                        | Сопровождение цели                                     |
| TEST         | Test                                   | Проверка (испытание)                                   |
| TIME         | Time                                   | Время  |
| TD           | Time difference                        | Разница во времени                                     |
| TOA          | Time of arrival                        | Время прибытия   |
| TOD          | Time of departure                      | Время отбытия  |
| TCPA         | Time to CPA                            | Время сближения на кратчайшее расстояние               |
| TTG          | Time to go                             | Время перехода   |
| TWOL         | Time to wheel over line                | Время подхода к линии поворота                         |
| TRK          | Track                                  | Путь судна   |
| TCS          | Track control system                   | Система управления траекторией судна                   |
| TMG          | Track made good                        | Заданный путь  |
| TRAIL        | Trail                                  | След   |
| TPL          | Transferred line of position           | Смещенная линия положения                              |
| THD          | Transmitting heading device            | Устройство для передачи курса                          |

Table 5.7.58-1 — continued

| Abbreviation | Term used  |  |
|--------------|--|--|
|              | English  | Russian  |
| TRIAL        | Trial  | Проигрывание                                     |
| TRIG         | Trigger pulse                                      | Триггерный импульс                               |
| TM           | True motion  | Истинное движение                                |
| TUNE         | Tune   | Настройка  |
| UHF          | Ultrahigh frequency                                | Сверхвысокая частота                             |
| UTC          | Universal time coordinated                         | Универсальное координированное время             |
| VRM          | Variable range marker                              | Подвижный индекс                                 |
| VAR          | Variation  | Склонение  |
| VECT         | Vector   | Вектор   |
| VHF          | Very high frequency                                | Высокая частота                                  |
| VLf          | Very low frequency                                 | Сверхнизкая частота                              |
| GRND         | Vessel aground                                     | Судно, сидящее на грунте                         |
| ANCH         | Vessel at anchor                                   | Судно на якорю                                   |
| VCD          | Vessel constrained by draught                      | Судно, стесненное своей осадкой                  |
| DIVE         | Vessel engaged in diving operation                 | Судно, занятое водолазными работами              |
| DRG          | Vessel engaged in dredging or underwater operation | Судно, занятое дноуглубительными работами        |
| TOW          | Vessel engaged in towing operation                 | Судно, занятое буксировкой                       |
| NUC          | Vessel not under command                           | Неуправляемое судно                              |
| RIM          | Vessel restricted in maneuverability               | Судно, ограниченное в возможности маневрирования |
| VTs          | Vessel traffic service                             | Система управления движением судов               |
| VID          | Video  | Видео  |
| VDR          | Voyage data recorder                               | Регистратор данных рейса                         |
| WARNING      | Warning  | Предупреждение                                   |
| WAT          | Water  | Вода   |
| WPT          | Waypoint   | Путевая точка                                    |
| W            | West   | Запад  |
| WOL          | Wheel over line                                    | Линия подачи команды на перекладку руля          |
| WOT          | Wheel over time                                    | Время подачи команды на перекладку руля          |
| X - BAND     | X – band   | Полоса частот – X диапазона                      |

Table 5.7.58-2

| Abbreviation | Term used         |                                    |
|--------------|-------------------|------------------------------------|
|              | English           | Russian                            |
| bl           | cable length      | кабелтов (расстояние)              |
| ps           | cycles per second | частота (число периодов в секунду) |
| deg          | degree (s)        | градус (ы)                         |
| fm           | fathom (s)        | сажени                             |
| ft           | feet / foot       | футы                               |
| GHz          | Gigahertz         | гигагерцы (ГГц)                    |
| hPa          | HectoPascal       | гектопаскали (гПа)                 |
| Hz           | Hertz             | герцы (Гц)                         |
| hr           | hour (s)          | час (ы)                            |
| kHz          | Kilohertz         | килогерцы (кГц)                    |
| km           | Kilometer         | километры (км)                     |
| kPa          | Kilopascal        | килопаскали (кПа)                  |
| kn           | knot (s)          | узлы                               |
| MHz          | Megahertz         | мегагерцы (МГц)                    |
| min          | minute (s)        | минуты                             |
| NM           | nautical mile (s) | морские мили                       |

be met through angles of heel 10° either side of vertical. For other sailing vessels, these requirements shall be met through angles of heel 20° or more either side of vertical.

**5.8.6** The radar reflector shall be clearly and respectively marked where it meets the requirements specified in 5.8.2 at  $\pm 20^\circ$  inclination (heel).

**5.8.7** The manufacturer recommended mounting height (not less than 4 m) and any preferred orientation shall be clearly marked directly on the radar reflector.

**5.8.8** Active radar reflectors shall conform to relevant requirements of International Telecommunication Union (ITU).

**5.8.9** The radar reflector shall be capable of maintaining its reflection performance under the conditions of sea states and action of any climatic and mechanical factors specified in 5.1.2.

## 5.9 RADIOBEACON STATION





**5.9.1** The basic technical and operational parameters of the radiobeacon station are specified in Table 5.9.1.

Table 5.9.1

| Nos | Parameter   | Value        |
|-----|---|--------------|
| 1   | Frequency range, kHz (four frequencies tuning by clamping method) | 315 to 526,5 |
| 2   | Class of emissions  | A2A          |
| 3   | Modulating frequency under all destabilizing factors, Hz          | $400 \pm 25$ |

Table 5.7.58-3

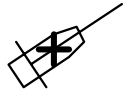
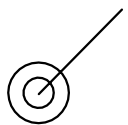
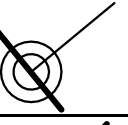
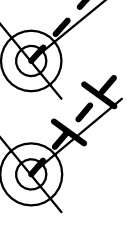
Table 5.7.58-3 — continued

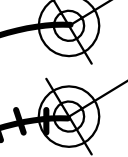
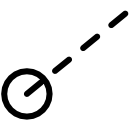
| Symbols                                   |   |   |
|---|---|---|
| Topic                                     | Symbol  | Description   |
| <b>Own Ship Symbols</b>                   |   |   |
| Own ship                                  |    | Double circle, located at common reference position.<br>Use of the symbol is optional, if own ship position is shown by the combination of heading line and beam line.  |
| Own Ship True Scale Outline               |    | The symbol size corresponds to the image scale. The true scale outline is oriented along own ship's heading. The position of the symbol is the common reference point.  |
| Own Ship Radar Aerial Position            |    | Cross located at the physical location of the radar aerial that is the current source of displayed radar video.   |
| Own Ship Heading Line                     |    | Solid line whose length is limited by bearing scale. If the bearing scale is not displayed the heading line shall have a limited length. Origin is at the common reference point.   |
| Own Ship Beam Line                        |   | Solid line of fixed or variable length. Midpoint is at common reference point.  |
| Own Ship Speed Vector                     |  | Dashed line — short dashes with spaces approximately twice the line width of heading line. Time increments may optionally be marked along the dashed line using short intersecting lines. To indicate water/ ground stabilization one or two arrowheads, respectively, may be added at the speed vector endpoint.                 |
| Own Ship Path Prediction                  |  | A curved vector may be provided as a path predictor.  |
| Own Ship Past Track                       |  | Thick line for primary source of navigational information. Thin line for secondary source. Optional time marks are allowed.   |
| <b>Tracked Radar Target Symbols</b>       |   |   |
| Tracked Target including Dangerous Target |  | Solid filled or unfilled circle. The speed vector shall be displayed as dashed line with short dashes with spaces approximately twice the line width. Optionally, time increments may be marked along the vector. For a dangerous target bold red (on colour display) solid circle with speed vector flashing until acknowledged. |













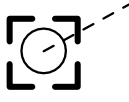
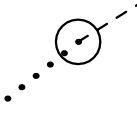



| Topic   | Symbol   | Description   |
|---|--|---|
| Target in Acquisition State                     |    | Circle segments. For automatic acquisition, bold circle segments, flashing and red (on colour display) until acknowledged.  |
| Lost Target                                     |    | Bold lines across the circle, flashing until acknowledge  |
| Selected Target                                 |    | A square indicated by its corners centred around the target symbol. Dots, equally spaced by time  |
| Target Past Positions                           |    | Large R adjacent to designated tracked target.  |
| Tracked Reference Target                        | <b>R</b>   | Multiple reference targets shall be marked as R1, R2, R3, etc.  |
| <b>AIS Target Symbols</b>                       |  |   |
| AIS Target (sleeping)                           |  | An isosceles, acute-angled triangle shall be used. The triangle shall be oriented by heading or course over ground. The reported position shall be located at half the height of the triangle. The symbol of the sleeping target shall be smaller than that of the activated target.  |
| Activated AIS Target Including Dangerous Target |  | An isosceles, acute-angled triangle shall be used. The triangle shall be oriented by heading or course over ground. The speed over ground vector shall be displayed as a dashed line with short dashes with spaces approximately twice the line width. The heading shall be displayed as a solid line with length twice of the length of the triangle symbol. Origin of the heading line is the apex of the triangle. The turn shall be indicated by a short intersecting line. A path predictor may be provided as curved vector. For a Dangerous AIS Target bold, red (on colour display) solid triangle with speed vector flashing until acknowledged. |
| AIS Target — True Scale Outline                 |  | A true scale outline may be added to the target symbol if the selected range scale makes this action possible.  |
| Selected Target                                 |  | A square indicated by its corners.  |

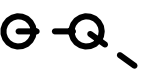

Table 5.7.58-3 — continued

| Topic                           | Symbol  | Description   |
|---------------------------------|---|---|
| Lost Target                     |    | Triangle with bold solid cross. The cross shall have a fixed orientation. The triangle shall be oriented per last heading value. The symbol shall flash until acknowledged. |
| Target Past Positions           |    | Dots, equally spaced by time.   |
| <b>Other Symbols</b>            |   |   |
| Real Position of Charted Object |    | Diamond with crosshair centred at reported position.  |
| Virtual Position                |    | Diamond with crosshair centred at reported position.  |
| Monitored Route                 |   | Dashed bold line, waypoints as circles.   |
| Planned or Alternate Route      |  | Dotted lines, waypoints as circles.   |
| Trial Manoeuvre                 |  | Large T on screen.  |
| Simulation Mode                 |  | Large S on screen.  |
| Cursor                          |  | Crosshair (two alternatives).   |
| Range Rings                     |   | Solid circles.  |
| Variable Range Markers          |   | Circle.   |
| Electronic bearing Lines        |   | Dashed line.  |
| Acquisition /Activation Area    |   | Solid line boundary for an area.  |
| Event Mark                      |  | Rectangle with diagonal line, clarified by added text (e.g. "MOB" for man overboard case).  |

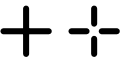
The tolerance of frequency of radiobeacon station shall not exceed 100 Hz.

**5.9.2** The transmitter shall be capable of transmitting audio modulated fluctuations of frequencies 400 Hz with continuity of carrier frequency and automatically producing two-letter signal of Morse signals with interval of half a minute and speed of 5 bauds.

Duration of signals:

"dot", ms —  $240 \pm 10$  per cent;

"dash", ms —  $720 \pm 10$  per cent.

**5.10 TRANSMITTING HEADING DEVICE**

**5.10.1** The transmitting heading device operating together with a sensing part (heading sensor) in latitudes of up to  $70^\circ$  shall comply with the following requirements (subject to the sensing part remaining operative under the conditions likely to be encountered during the ship's service (including high-speed):

.1 the transmission and resolution error shall be not be more than  $\pm 0,2^\circ$ ;

.2 the static error measured at permanent speed and direction of the ship shall be less than  $\pm 1,0^\circ$ ;

.3 the dynamic error measured under the conditions of roll, pitch, vibration, or change of speed shall not be more than  $\pm 1,5^\circ$ . If the amplitude of the dynamic error exceeds  $\pm 0,5^\circ$  the dynamic error frequency shall be less than 0,033Hz (with a period of no more than 30 s);

.4 the follow-up error for different rates of turn shall not be more than:

$\pm 0,5^\circ$  at rates up to  $10^\circ/s$ ;

$\pm 1,5^\circ$  between a rate of  $10^\circ/s$  and  $20^\circ/s$ .

**5.10.2** Any controls and correcting devices to introduce modifications in the true heading information transmitted by the device shall be protected from inadvertent operation.

**5.10.3** Manually settable values used for electronic correction shall be indicatable by adequate means.

**5.10.4** A visual and/or sound alarm shall be provided to indicate malfunctions of the device or a failure of the power supply.

### 5.11 RADIONAVIGATION SYSTEM RECEIVERS

**5.11.1** Radionavigational system receivers shall comply with general requirements of 5.1, Part IV "Radio Equipment", as well as provide for the following:

**.1** required accuracy of the ship's positioning in accordance with the type of the employed radionavigational system or systems;

**.2** possibility of its interfacing with navigational equipment and integrated navigational system. The data display shall be in compliance with Standard Communication Protocol and Data Format in accordance with IEC 61162 series as applicable;

**.3** check of the system working ability by built-in control system;

**.4** receiver input protection in accordance with 4.6.10 and 4.6.11 of Part IV "Radio Equipment";

**.5** a 5 minute protection interval, for preventing damage to the receiver, its any input and output connections, as well as any receiving equipment input and output;

**.6** continuous work in actual operation conditions;

**.7** use of different number of combined signal receiving channels which receive signals both from the global satellite navigational systems and from radionavigational system earth stations with the use of such wide area differential subsystems as WAAS (Wide Area Augmentation System), EGNOS (European Geostationary Navigation Overlay Service) and MSAS (Multifunctional Satellite Augmentation System), space differential subsystem (Space Base Augmentation System — SBAS), and regional differential subsystems such as Starfix, SkyFix and Eurofix/Scorpio.

**5.11.2** The GNSS GPS (Global Positioning System) receiver intended for navigation purposes on ships of speeds not exceeding 70 knots should include the following minimum facilities:

**.1** antenna capable of receiving GPS signals;

**.2** GPS receiver and processor;

**.3** means of computing latitude/ longitude position;

**.4** data control and interface;

**.5** geographical position display and have, if it is required, other forms of output.

**5.11.2.1** The GPS receiver should comply with the following minimum performance standards and provide for:

**.1** receiving and processing SPS (Standard Positioning Service) signals in SA (Selective Availability) mode of operation, providing position information in latitude and longitude basing on WGS-84 (World Geodetic System 1984) Datum in

degrees, minutes and thousandths of minutes and time referenced to UTC (Universal Time Coordinated). Means shall be provided for converting the coordinates determined in WGS-84 System into the Reference System of the navigational chart in use. If such a possibility is provided, then the ship's position conversion mode shall be shown on the receiver information display with the indication of the employed system in which the ship's position is determined;

**.2** operation on the L1 (1575,42 MHz) frequency and in C/A (Coarse/Acquisition) code. It is also recommended to provide operation on the L2 (1227,6 Hz) frequency with the use of (Precise) code;

**.3** static accuracy such that the position of the antenna is determined to within: 100 m (95 %) with HDOP (Horizontal Dilution of Precision) factor equalling 4 or PDOP (Positional Dilution of Precision) factor equalling 6;

**.4** dynamic accuracy such that the position of the ship under the sea states and motion experienced in ships is determined to within: 100 m (95 %) with HDOP factor equalling 4 or PDOP factor equalling 6;

**.5** selecting automatically the appropriate satellite-transmitted signals to determine the ship's position with the required accuracy and update rate;

**.6** acquiring and processing satellite signals with input carrier levels in the range of  $-130$  dBm to  $-120$  dBm. Once the satellite signals have been acquired, the equipment should continue to operate satisfactorily with satellite signals having carrier levels down to  $-133$  dBm;

**.7** acquiring the first position reading to the required accuracy within 30 minutes when there is no valid almanac data in the receiver memory;

**.8** acquiring the first position reading to the required accuracy within 5 minutes when there is valid almanac data in the receiver memory;

**.9** re-acquiring position to the required accuracy within 5 minutes when there has been a service interruption of 24 hours or less, but the energy supply has not been interrupted;

**.10** re-acquiring position to the required accuracy within 2 minutes when there has been an energy supply interruption of up to 60 seconds;

**.11** generating and outputting to a display and digital interface a new position solution at least once every 1 s;

**.12** position resolution equal to or better than 0,001 minutes of latitude and longitude;

**.13** COG (Course Over the Ground), SOG (Speed Over the Ground) and UTC outputs, showing these values on the information display and other radio and navigational equipment connected to the receiver. The outputs should have a validity mark aligned with that on the position output.

The accuracy requirements for COG and SOG should not be inferior to the relevant performance standards for heading and speed and distance measuring equipment;

**.14** possibility of acquiring and processing correction signals from dGPS (Differential GPS) subsystem in accordance with the ITU (International Telecommunications Union) Recommendations and relevant RTCM (Radio Technical Commission for Maritime Services) Standard. If the GPS receiver is fitted with a facility for acquiring and processing the correction signals from the differential subsystem, its performance standards for static and dynamic accuracy (see 5.11.2.1.3 and 5.11.2.1.4) shall be at least 10 m (95 %).

**5.11.2.2** The receiver shall provide indication if the calculated position does not correspond to these operational requirements.

**5.11.2.3** The receiver should provide a warning within 5 s if:

**.1** HDOP factor exceeds the established limit;

**.2** a new position has not been calculated for more than 1 s.

Under such conditions the last known position and the time of the last valid fix, with the explicit indication of the state so that no ambiguity can exist, should be output until normal operation is resumed.

**5.11.2.4** If it is impossible to determine the ship's position, an alarm signal shall be given by the receiver.

**5.11.2.5** The receiver shall provide indication of the differential mode of operation in case of:

**.1** receiving differential correction signals;

**.2** considering differential corrections in the displayed ship's position.

**5.11.2.6** The receiver shall provide timely indication if the differential mode of operation cannot be used.

**5.11.2.7** The receiver shall provide the display of the differential mode text message.

**5.11.3** The GNSS GLONASS receiver intended for navigation purposes on ships of speeds not exceeding 70 knots should include the following minimum facilities:

**.1** antenna capable of receiving GLONASS signals;

**.2** GLONASS receiver and processor;

**.3** means of computing latitude/ longitude position;

**.4** data control and interface;

**.5** geographical position display

and have, if it is required, other forms of output.

**5.11.3.1** The GLONASS receiver should comply with the following minimum performance standards and provide for:

**.1** receiving and processing GLONASS SPS (Standard Positioning Service) signals, providing

position information in latitude and longitude basing on PE-90 Reference System in degrees, minutes and thousandths of minutes and time referenced to UTC. Means shall be provided for converting the coordinates determined in PE-90 System into WGS-84 System or into the Reference System of the navigational chart in use. If such a possibility is provided, then the ship's position conversion mode shall be shown on the receiver information display with the indication of the employed system in which the ship's position is determined;

**.2** operation in the Standard Positioning Service mode on the L1 (1602,5625 – 1615,5 MHz) frequencies and in C Code;

**.3** static accuracy such that the position of the antenna is determined to within: 45 m (95 %) with HDOP factor equalling 4 or PDOP factor equalling 6;

**.4** dynamic accuracy such that the position of the ship under the sea states and motion experienced in ships is determined to within: 45 m (95 %) with HDOP factor equalling 4 or PDOP factor equalling 6 under the sea states and motion experienced in ships;

**.5** selecting automatically the appropriate satellite-transmitted signals to determine the ship's position with the required accuracy and update rate;

**.6** acquiring and processing satellite signals with input carrier levels in the range of –130 dBm to –120 dBm. Once the satellite signals have been acquired, the equipment should continue to operate satisfactorily with satellite signals having carrier levels down to –133 dBm;

**.7** acquiring the first position reading to the required accuracy within 30 minutes when there is no valid almanac data in the receiver memory;

**.8** acquiring the first position reading to the required accuracy within 5 minutes when there is valid almanac data in the receiver memory;

**.9** re-acquiring position to the required accuracy within 5 minutes when there has been a service interruption of 24 hours or less, but the energy supply has not been interrupted;

**.10** re-acquiring position to the required accuracy within 2 minutes when there has been an energy supply interruption of up to 60 seconds;

**.11** generating and outputting to a display and digital interface a new position solution at least once every 1 s;

**.12** position resolution equal to or better than 0,001 minutes of latitude and longitude;

**.13** COG (Course Over the Ground), SOG (Speed Over the Ground) and UTC outputs, showing these values on the information display and other radio and navigational equipment connected to the receiver. The outputs should have a validity mark aligned with that on the position output.

The accuracy requirements for COG and SOG should not be inferior to the relevant performance standards for heading and speed and distance measuring equipment;

**.14** possibility of acquiring and processing correction signals from dGPS (Differential GPS) subsystem in accordance with the ITU Recommendations and relevant RTCM Standard. If the GLONASS receiver is fitted with a facility for acquiring and processing the correction signals from the differential subsystem, its performance standards for static and dynamic accuracy (see 5.11.3.1.3 and 5.11.3.1.4) shall be at least 10 m (95 %).

**5.11.3.2** The receiver shall provide indication if the calculated position does not correspond to these operational requirements.

**5.11.3.3** The receiver should provide a warning within 5 s if:

**.1** HDOP factor exceeds the established limit;

**.2** a new position has not been calculated for more than 1 s.

Under such conditions the last known position and the time of the last valid fix, with the explicit indication of the state so that no ambiguity can exist, should be output until normal operation is resumed.

**5.11.3.4** If it is impossible to determine the ship's position, an alarm signal shall be given by the receiver.

**5.11.3.5** The receiver shall provide indication of the differential mode of operation in case of:

**.1** receiving differential correction signals;

**.2** considering differential corrections in the displayed ship's position.

**5.11.3.6** The receiver shall provide timely indication if the differential mode of operation cannot be used.

**5.11.3.7** The receiver shall provide the display of the differential mode text message.

**5.11.4** The combined GPS GLONASS receiver intended for navigation purposes on ships of speeds not exceeding 70 knots should include the following minimum facilities:

**.1** antenna capable of receiving GPS and GLONASS signals;

**.2** GPS and GLONASS combined receiver and processor;

**.3** means of computing latitude/ longitude position;

**.4** data control and interface;

**.5** geographical position display.

**5.11.4.1** The GPS/GLONASS receiver should comply with the following minimum performance standards and provide for:

**.1** receiving and processing SPS (Standard Positioning Service) signals when the SA (Selective Availability) mode of operation and GLONASS

system range determining code are switched on, providing position information in latitude and longitude which is referred to WGS-84 Datum in degrees, minutes and thousandths of minutes and time referenced to UTC. Means shall be provided for converting the coordinates determined in WGS-84 Reference System into PE-90 System or into the Reference System of the navigational chart in use. If such a possibility is provided, then the ship's position conversion mode shall be shown on the receiver information display with the indication of the employed system in which the ship's position is determined;

**.2** operation on the L1 (1575,42 MHz) frequency and in / (Coarse/Acquisition) code of GPS system and on the L1 (1602,5625 — 1615,5 MHz) frequencies and in C Code of GLONASS system;

**.3** static accuracy such that the position of the antenna is determined to within: 35 m (95 %) without considering the differential subsystem signals and - 10 m (95 %) with considering the differential subsystem signals with HDOP factor 4 or PDOP factor 6;

**.4** dynamic accuracy such that the position of the ship under the sea states and motion experienced in ships is determined to within: 35 m (95 %) without considering the differential subsystem signals and - 10 m (95 %) with considering the differential subsystem signals with HDOP factor 4 or PDOP factor 6;

**.5** selecting automatically the appropriate satellite-transmitted signals to determine the ship's position with the required accuracy and update rate;

**.6** acquiring and processing satellite signals with input carrier levels in the range of -130 dBm to -120 dBm. Once the satellite signals have been acquired, the equipment should continue to operate satisfactorily with satellite signals having carrier levels down to -133 dBm;

**.7** acquiring the first position reading to the required accuracy within 30 minutes when there is no valid almanac data in the receiver memory;

**.8** acquiring the first position reading to the required accuracy within 5 minutes when there is valid almanac data in the receiver memory;

**.9** re-acquiring position to the required accuracy within 5 minutes when there has been a GPS/GLONASS service interruption of 24 hours or less, but the energy supply has not been interrupted;

**.10** re-acquiring position to the required accuracy within 2 minutes when there has been an energy supply interruption of up to 60 seconds;

**.11** re-acquiring of a separate satellite signal and using such signal for positioning within 10 s after blocking the signal for a period up to 30 s; generating and outputting to a display and digital interface a new position solution at least once every 1 s;

**.12** generating and outputting to a display and digital interface a new position solution at least once every 1 s;

**.13** position resolution equal to or better than 0,001 minutes of latitude and longitude;

**.14** COG, SOG and UTC outputs, showing these values on the information display and other radio and navigational equipment connected to the receiver. The outputs should have a validity mark aligned with that on the position output.

The accuracy requirements for COG and SOG should not be inferior to the relevant performance standards for heading and speed and distance measuring equipment;

**.15** possibility of acquiring and processing correction signals from dGPS (Differential GPS) subsystem and dGLONASS (Differential GLO-NASS) in accordance with the ITU Recommendations and relevant RTCM Standard.

**5.11.4.2** The receiver shall provide indication if the calculated position does not correspond to these operational requirements.

**5.11.4.3** The receiver should provide a warning within 5 s if:

**.1** HDOP factor exceeds the established limit;

**.2** a new position has not been calculated for more than 1 s.

Under such conditions the last known position and the time of the last valid fix, with the explicit indication of the state so that no ambiguity can exist, should be output until normal operation is resumed.

**5.11.4.4** If it is impossible to determine the ship's position, an alarm signal shall be given by the receiver.

**5.11.4.5** The receiver shall provide indication of the differential mode of operation in case of:

**.1** receiving differential correction signals;

**.2** considering differential corrections in the displayed ship's position.

**5.11.4.6** The receiver shall provide timely indication if the differential mode of operation cannot be used.

**5.11.4.7** The receiver shall provide the display of the differential mode text message.

**5.11.5** The equipment for receiving signals from the radiobeacons transmitting corrections from the dGPS and dGLONASS differential subsystems intended for navigation purposes on ships of speeds not exceeding 70 knots should include the following minimum facilities:

**.1** antenna capable of receiving dGPS or dGLO-NASS correction signals from marine radiobeacons;

**.2** dGPS and dGLONASS correction signals receiver and processor;

**.3** data control and interface.

**5.11.5.1** The equipment for receiving signals from radiobeacons should comply with the following minimum performance standards and provide for:

**.1** reception and processing of dGPS and dGLONASS differential subsystems radiobeacon signals within a frequency range from 283,5 to 325 kHz in compliance with the ITU Recommendations and relevant RTCM Standard;

**.2** facilities for automatic and manual station selection;

**.3** possibility of using data with a delay not exceeding 100 ms after the signal reception;

**.4** acquiring and processing of the signal within 45 s in atmospheric clutter conditions;

**.5** availability of an antenna which is nondirectional in the horizontal plane.

**5.11.6** The Galileo satellite system receiver intended for navigation purposes on ships of speeds not exceeding 70 knots should include the following minimum facilities:

**.1** antenna capable of receiving Galileo signals;

**.2** Galileo receiver and processor;

**.3** means of accessing the computed latitude/longitude position;

**.4** data control and interface; and

**.5** position display and, if required, other displays/outputs.

If Galileo forms a part of an approved INS (Integrated Navigation System), requirements of 5.11.6.3, 5.11.6.4 and 5.11.6.5 may be provided within the INS.

**5.11.6.1** The Galileo receiver should:

**.1** be capable of receiving and processing the Galileo positioning and velocity, and timing signals on: for a single frequency receiver, the L1 frequency alone in the frequency range of 1559–1591 MHz (the receiver should use the ionospheric model broadcast to the receiver by the constellation to generate ionospheric corrections); and for a dual frequency receiver, either on the L1 and E5b frequencies in the ranges of 1164–1215 MHz and 1559–1591 MHz frequencies or on the L1 and E5a frequencies in the ranges of 1164–1215 MHz and 1559–1591 MHz frequencies (the receiver should use dual frequency processing to generate ionospheric corrections).

It is recommended to provide the reception and processing of the Galileo system signal on three frequencies: the L1, 5 and 5;

**.2** provide position information in latitude and longitude in degrees, minutes and thousandths of minutes and provide time referenced to universal time coordinated UTC;

**.3** have static accuracy such that the position of the antenna is determined to within: 15 m horizontal (95 %) and 35 m vertical (95 %) for single frequency operations on the L1 frequency; and 10 m horizontal

(95 %) and 10 m vertical (95 %) for dual frequency operations on the L1 and E5a or L1 and E5 frequencies with PDOP factor 3,5;

**.4** have dynamic accuracy equivalent to the static accuracy under the sea states and motion experienced in ships;

**.5** have position resolution equal or better than 0,001 min of latitude and longitude;

**.6** have timing accuracy such that time is determined within 50 ns of UTC;

**.7** be capable of selecting automatically the appropriate satellite-transmitted signals to determine the ship's position and velocity, and time with the required accuracy and update rate;

**.8** be capable of acquiring satellite signals with input signals having carrier levels in the range of -128 dBm to -118 dBm. Once the satellite signals have been acquired, the equipment should continue to operate satisfactorily with satellite signals having carrier levels down to -131 dBm;

**.9** be capable of acquiring position, velocity and time to the required accuracy within 5 min when there is no valid almanac data;

**.10** be capable of acquiring position, velocity and time to the required accuracy within 1 min when there is valid almanac data;

**.11** be capable of re-acquiring position, velocity and time to the required accuracy within 1 min when there has been a service interruption of 60 s or less;

**.12** generate and output to a display and digital interface a new position solution at least once every 1 s for conventional craft and at least once every 0,5 s for high-speed craft;

**.13** provide the COG, SOG and UTC outputs, with a validity mark aligned with that on the position output.

The accuracy requirements for COG and SOG should not be inferior to the relevant performance standards for the heading and speed and distance measuring equipment and the accuracy should be obtained under the various dynamic conditions that could be experienced onboard ships;

**.14** provide at least one normally closed contact, which should indicate failure of the Galileo receiver equipment;

**.15** have a bidirectional interface to facilitate communications so that alarms can be transferred to external systems and so that audible alarms from the Galileo receiver can be acknowledged from external systems.

The interface should comply with the relevant international standards;

**.16** have facilities to process differential Galileo (dGalileo) data fed to it in accordance with the standards of ITU Recommendations and the appropriate RTCM standard and provide indication of the

reception of dGalileo signals and whether they are being applied to the ship's position.

**5.11.6.2** The dGalileo receiver equipment should also indicate whether the performance of Galileo is outside the bounds of requirements for general navigation in the ocean, coastal, port approach and restricted waters, and in inland waterway phases of the voyage.

**5.11.6.3** The Galileo receiver equipment should as a minimum:

**.1** provide a warning within 5 s of loss of position or if a new position based on the information provided by the Galileo constellation has been calculated for more than 1 s for conventional craft and 0,5 s for high-speed craft.

Under such conditions the last known position and the time of last valid fix, with explicit indication of the state so that no ambiguity can exist, should be output until normal operation is resumed;

**.2** use RAIM (Receiver Autonomous Integrity Monitoring) to provide integrity performance appropriate to the operation being undertaken.

**5.11.6.4** For receivers having the capability to process the Galileo Safety of Life Service, integrity monitoring and alerting algorithms should be based on a suitable combination of the Galileo integrity message and receiver autonomous integrity monitoring (RAIM). The receiver should provide an alarm within 10 s Time to Alarm (TTA) of the start of an event if an alert limit of 25 m Horizontal Alert Limit (HAL) is exceeded for a period of at least 3 s. The probability of detection of the event should be better than 99, 999 % over a 3-h period (integrity risk 10-5/3 h).

**5.11.7** If receivers of earth radionavigational systems or combined (multichannel) receivers acquiring also signals from earth radionavigational systems are provided for installation on board ships, they should comply with minimum requirements stipulated in 5.12 of Part V "Navigational Equipment" of Rules for the Equipment of Sea-Going Ships, 2005, taking into consideration the Notice (2006) to Rules for the Equipment of Sea-Going Ships of 2005.

## 5.12 COMBINED SHIP CONTROL DESKS

**5.12.1** Controls and indicating instruments of navigational equipment and of other gears for ship handling required by the present or other parts of the Rules and intended for installation in the wheelhouse or in a place from which the ship is operated may be arranged in the combined ship control desks.

**5.12.2** Referred to the controls and indicating instruments mentioned in 5.12.1 are the controls and instruments intended for:

**.1** changing the ship's movement (remote control of main engines, blades of controllable pitch propellers, propeller shaft tachometers, pitch indicators of the CPP, etc.);

**.2** communicating orders and recording commands on changes on ship's movement by electro-mechanical means (engine telegraphs, reverse recorders, etc.);

**.3** observing navigational features in the area concerned (radar displays, depth indicators, hydro-locators, anchor cable indicators, etc.);

**.4** indicating the values relating to the ship's movement (course, speed, distance, helm, rate of turn, draught indicators, etc.);

**.5** controlling very high frequency radio communication means (remote controls and voice communicating devices);

**.6** external audible and visual signalling (manual controls for whistles, timing units for automatic generation of sound and light signals, remote controls of electric megaphones, masthead flashing light and day signalling lamps keying devices, navigation lanterns commutators, etc.);

**.7** internal communication and audible signalling (telephones of two-way communication, commutators of service telephone communication, telephones of ship's automatic exchange, commutators of command broadcast system, alarm signalling switches, etc.);

**.8** ensuring survivability of the ship and other essential operations (watertight and fire doors closing, starting of fire fighting systems, control of anchor arrangement, ventilation of accommodation and service spaces and holds, thruster and active rudder, etc.);

**.9** audible and visual signalling to indicate any failure and executive signalling to indicate given command fulfilment (general and individual signalling on failures of essential machinery, systems and gears, signalling on limit values of various parameters, for example, temperature, pressure, revolutions, depths, etc.);

**.10** automated and automatic control of the ship and for making decisions on passing and preventing collisions of ships at sea;

**.11** distribution, switchgear and protection devices provided in Part XI "Electrical Equipment" of Rules for the Classification and Construction of Sea-Going Ships.

**5.12.3** Provision shall be made in the design of the combined ship control desk for the appropriate panels for free and convenient arrangement of necessary controls and indicating instruments and its inner spaces shall be sufficient for arrangement of inner wiring and devices in accordance with 5.12.2.11, if any.

**5.12.4** The combined ship control desk may be designed both as one common unit and as separate sections, mechanically and electrically connected with one another, the controls and indicating instruments may also be fitted in separately standing desks.

**5.12.5** The dimensions of the combined ship control desk shall be such as to provide the fulfilment of the requirements of 5.12.3 with respect to the devices and instruments built into the desk, as well as the possibility of using controls and observing the instruments, controls and signalling means installed therein when the operator stands facing the ship's bow and to prevent interference for look-outs.

**5.12.6** The requirements of 5.12.5 shall be considered fulfilled, if the following conditions are met:

**.1** the height of the desk vertical panels or boards with controls or indicating and other instruments arranged at the bulkheads with no scuttles therein is such that the above controls and instruments are not lower than 650 mm and not higher than 2000 mm;

**.2** the depth of separate sections of the whole desks fitted at the fore bulkhead of the wheelhouse ensures the access to the scuttles.

**5.12.7** The panels of the combined ship control desk may be inclined at any angle ensuring the most exact taking of readings from the indicating instruments and convenient use of controls.

**5.12.8** All controls shall be so installed as to be easily accessible for the personnel and close to the indicators and instruments related thereto or made integral with the latter within the boundaries clearly indicated on the panel. They shall have distinct markings showing the purpose and the direction of the control operation.

**5.12.9** Indicating devices installed on the combined ship control desk shall provide for continuous and automatic information.

The use of indicating devices giving the information only on call of the operator is permitted.

**5.12.10** Where the audible and visual signalling systems capable of indicating any fault in the operation of instruments and machinery are provided, the audible signal shall be clearly heard at any point of the navigating bridge. Signals of various tones shall be used, where necessary.

Controls of emergency systems installed in the desk shall be of red colour. The corresponding portions of scales of instruments intended for indicating emergency and pre-emergency conditions in the systems shall be painted red. In this case:

**.1** confirmative signals of starting machinery, systems and arrangements shall function not from the movement or position of controls, but from pulses directly characterizing the working condition of the item of machinery, system or arrangement concerned;

.2 depending on the meaning of light signals, the colour of symbols and letters of indicating inscriptions shall be green for normal operating conditions and red for emergency conditions;

.3 the above colours of light signals shall be used in accordance with the requirements of 5.1.29.

**5.12.11** Controls arranged in compliance with 5.12.8 shall be so designed that the direction of movement of steering wheel, handle, lever, switch, etc. corresponds to the change of the parameter to be controlled as it is provided by 3.1.3 and 3.1.4, Part VII "Machinery Installations" and Part XI "Electrical Equipment" of Rules for the Classification and Construction of Sea-Going Ships.

**5.12.12** Controls and devices built in the combined ship control desk shall be fed in compliance with the requirements of 2.3.4 of the present Part or from the distribution gear put in the combined ship control desk and meeting the requirements of Part XI "Electrical Equipment" of Rules for the Classification and Construction of Sea-Going Ships.

**5.12.13** The combined ship control desk shall be so designed or its separate sections shall be so assembled that controls and indicating instruments vital for the safety of ship's navigation and intended for immediate use under extraordinary circumstances when the ship is under way shall be arranged in the desk to the right from the centre line. This condition will be fulfilled if the controls and indicating instruments listed in 5.12.2.1 to 5.12.2.6 are placed from the starboard to the centre line, in ascending order.

Controls and indicating instruments listed in 5.12.2.7 to 5.12.2.9 as well as in 5.12.2.10 may be arranged to the left from the centre line.

### 5.13 INTEGRATED NAVIGATION SYSTEM

**5.13.1** The integrated navigation system shall combine individual navigational devices and equipment to process and display jointly the information received therefrom and maintain automatic control over its integrity and reliability in order to monitor continuously navigational environment and provide appropriate warnings.

According to the extent of functions performed, integrated navigation systems shall be subdivided into three categories:

Category A — systems providing processing and displaying data on a heading, speed and ship's position, and also on a current time;

Category B — systems providing automatic processing and displaying data on a heading, speed, current ship's position, and also on a depth, and a generation of warning about hazards known and detected along the pre-planned route;

Category C — systems providing, in addition to the category B functions, automatic control of the ship as to a heading, track or speed, and carrying out monitoring control parameters.

**5.13.2** The integrated navigation system shall not impair characteristics of navigational devices and equipment which are part of it.

**5.13.3** In case of failure of data processing individual units, the serviceability of all navigational devices and equipment, which are part of an integrated navigation system, shall be ensured.

**5.13.4** A malfunction or failure of any navigational device or equipment, which are part of an integrated navigation system, shall not affect other parts of the system except for those whose serviceability is directly dependent upon the failed part.

A restoration of an integrated navigation system functioning after its failure shall be possible only after an advance notice of an operator and his confirmation that a system is ready for working.

**5.13.5** The navigational information from the navigational sensors shall be interfaced with the system automatically. Manual input of some data may be provided if a sensor fails.

**5.13.6** An integrated navigation system shall make available for an operator the necessary navigational data, and also shall generate warnings if sensor data are invalid.

**5.13.7** The navigational equipment, which is a part of an integrated navigation system and ensures the safe ship's control, shall be duplicated.

**5.13.8** An integrated navigation system shall ensure a permanent automatic comparison of the navigational data derived independently from two sensors.

The navigational data displayed and information used in the automatic control system shall be previously processed in the comparison unit.

It shall be impossible to use invalid data in the automatic control system.

**5.13.9** The information necessary for the safe ship's control shall be permanently displayed by an integrated navigation system.

Additional data shall be displayed by a system on the operator's demand.

**5.13.10** The control of an integrated navigation system shall be carried out from a common control panel comprising system controls, means of data displaying and alarms actuation.

**5.13.11** An integrated navigation system shall ensure protection against operator's errors during data input.

**5.13.12** The integrated navigation system shall record every case of alarm operation and enable the officer on watch to confirm such operation.



#### 5.14 UNIFIED TIMING SYSTEM

**5.14.1** The unified timing system station shall ensure:

- .1** formation and storage of the time scale and its checking against the International accurate hour's service signals transmitted through the radio channels;
- .2** possibility of centralized shifting of displayed readings of the current time within 0 to 23 h with a step of 1 h;
- .3** indication of current time readings transmitted to the controllable clock in hours, minutes, seconds.

**5.14.2** The error of the main clock run shall not exceed 0,5 s during twenty-four-hour operation.

#### 5.15 ELECTRONIC CHART DISPLAY AND INFORMATION SYSTEM

**5.15.1** These performance standards should apply to all ECDIS equipment carried on all ships which are covered by these Rules, as follows:

- dedicated standalone workstation;
- multifunction workstation as part of integrated navigational system.

**5.15.2** These performance standards shall apply to ECDIS, ECDIS equipment operating in the Raster Chart Display System (RCDS) mode, as well as ECDIS backup arrangements.

**5.15.3** Requirements for structure and format of the chart data, encryption of the chart data as well as the presentation of chart data are within the scope of relevant International Hydrographic Organisation (IHO) standards.

**5.15.4** In addition to the requirements of this Chapter, ECDIS equipment should meet the applicable requirements of item 5.1 of Part IV "Radio Equipment" and 5.1 of this Part of the Rules, as well as of requirements of Rules for Bridge Design, Equipment, Arrangement and Procedures (see Appendix to this Part of the Rules).

**5.15.5** The Electronic Chart Display and Information System should be capable of displaying all chart information of the System Electronic Navigational Chart (SENC) originated by the authorized hydrographic offices.

**5.15.6** ECDIS should facilitate simple and reliable updating of the electronic navigational chart.

**5.15.7** ECDIS should enable the mariner to execute in a convenient and timely manner all route planning and route monitoring, and it should be capable of continuously plotting the ship's position.

**5.15.8** The ECDIS display may also be used for the display of radar, radar tracked target information, AIS and other appropriate data layers to assist in route monitoring.

**5.15.9** ECDIS should have at least the same reliability and availability of presentation as the paper chart published by government authorized hydrographic offices.

**5.15.10** ECDIS should provide appropriate alarms or indications with respect to the information displayed or malfunction of the equipment.

**5.15.11** ECDIS equipment may operate in the Raster Chart Display System mode.

RCDS mode of operation should conform to performance standards stipulated in 5.15.108.

**5.15.12** The chart information to be used in ECDIS should be of the latest edition, as corrected by official updates, of that issued by or on the authority of a Government, government-authorized Hydrographic Office or other relevant government institution, and conform to IHO standards.

**5.15.13** The contents of the SENC should be adequate and up-to-date for the intended voyage.

**5.15.14** It should not be possible to alter the contents of the ENC or SENC information transformed from the ENC.

**5.15.15** Updates should be stored separately from the ENC.

**5.15.16** ECDIS should be capable of accepting official updates to the ENC data provided in conformity with IHO standards. These updates should be automatically applied to the SENC. By whatever means updates are received, the implementation procedure should not interfere with the display in use.

**5.15.17** ECDIS should also be capable of accepting updates to the ENC data entered manually with simple means for verification prior to the final acceptance of the data.

They should be distinguishable on the display from ENC information and its official updates and not affect display legibility.

**5.15.18** ECDIS should keep and display on demand a record of updates including time of application to the SENC. This record should include updates for each ENC until it is superseded by a new edition.

**5.15.19** ECDIS should allow the mariner to display updates in order to review their contents and to ascertain that they have been included in the SENC.

**5.15.20** ECDIS should be capable of accepting both non-encrypted ENCs and ENCs encrypted in accordance with the IHO Data Protection Scheme.

**5.15.21** ECDIS should be capable of displaying all SENC information. An ECDIS should be capable of accepting and converting an ENC and its updates into a SENC.

The ECDIS may also be capable of accepting a SENC resulting from conversion of ENC to SENC ashore in accordance with IHO requirements.

**5.15.22** SENC information available for display during route planning and route monitoring should be subdivided into the following three categories:

Display Base;  
Standard Display;  
all other information.

**5.15.22.1** The display base which is to be permanently shown on the ECDIS display consists of:

.1 coastline (high water);  
.2 own ship's safety contour;  
.3 isolated underwater dangers of depths less than the safety contour which lie within the safe waters defined by the safety contour;  
.4 isolated dangers which lie within the safe water defined by the safety contour, such as fixed structures, overhead wires, etc;

.5 scale, range and north arrow;  
.6 units of depth and height; and  
.7 display mode.

**5.15.22.2** The initial standard ECDIS display should consist of:

.1 display base;  
.2 drying line;  
.3 buoys, beacons, other aids to navigation and fixed structures;  
.4 boundaries of fairways, channels, etc;  
.5 visual and radar conspicuous features;  
.6 prohibited and restricted areas;  
.7 chart scale boundaries;  
.8 indication of cautionary notes;  
.9 ship's routeing systems and ferry routes;  
.10 archipelagic sea lanes.

**5.15.22.3** All other information that can be displayed individually on demand includes:

.1 spot soundings;  
.2 submarine cables and pipelines;  
.3 details of all isolated dangers;  
.4 details of all aids to navigation;  
.5 contents of cautionary notes;  
.6 ENC edition date;  
.7 most recent chart update number;  
.8 magnetic variation;  
.9 graticule;  
.10 place names.

**5.15.23** ECDIS should present the Standard Display at any time by a single operator action.

**5.15.24** When an ECDIS is switched on following a switch off or power failure, it should return to the most recent manually selected settings for display.

**5.15.25** It should be easy to add or remove information from the ECDIS display. It should not be possible to remove information contained in the Display Base.

**5.15.26** For any operator identified geographical position (e.g. by cursor picking) ECDIS should

display on demand the information about the chart objects associated with such a position.

**5.15.27** It should be possible to change the display scale by appropriate steps e.g. by means of either

chart scale values or  
ranges in nautical miles.

**5.15.28** It should be possible for the mariner to select a safety contour from the depth contours provided by the SENC. ECDIS should emphasize the safety contour over other contours on the display, however:

.1 if the mariner does not specify a safety contour, this should default to 30 m.

If the safety contour specified by the mariner or the default 30 m contour is not in the displayed SENC, the safety contour shown should default to the next deeper contour;

.2 if the safety contour in use becomes unavailable due to a change in source data, the safety contour should default to the next deeper contour;

.3 in each of the above cases, an indication should be provided.

**5.15.29** It should be possible for the mariner to select a safety depth. ECDIS should emphasize soundings equal to or less than the safety depth whenever spot soundings are selected for display.

**5.15.30** The ENC and all updates to it should be displayed without any degradation of their information content.

**5.15.31** ECDIS should provide a means to ensure that the ENC and all updates to it have been correctly loaded into the SENC.

**5.15.32** The ENC data and updates to it should be clearly distinguishable from other displayed information, including those listed below:

.1 own ship:  
past track with time marks for primary track;  
past track with time marks for secondary track;  
.2 vector for course and speed made good;  
.3 variable range marker and/ or electronic bearing line;  
.4 cursor;  
.5 event:  
dead reckoning position and time (DR);  
estimated position and time (EP);  
.6 fix and time;  
.7 position line and time;  
.8 transferred position line and time:  
predicted tidal stream or current vector with effective time and strength;  
measured tidal stream or current vector with effective time and strength;  
.9 danger highlight;  
.10 clearing line;  
.11 planned course and speed to make good;

- .12 waypoint;
  - .13 distance to run;
  - .14 planned position with date and time;
  - .15 visual limits of lights arc to show rising/dipping range;
  - .16 position and time of "wheel over".
- 5.15.33** ECDIS should provide an indication if:
- .1 the information is displayed at a larger scale than contained in the ENC;
  - .2 own ship position is covered by an ENC at a larger scale than provided by the display.

**5.15.34** Radar information and/ or AIS information may be transferred from systems compliant with the relevant standards of this Part of the Rules. Other navigational information may be added to the ECDIS display. However, it should not degrade the displayed SENC information and it should be clearly distinguishable from the SENC information.

**5.15.35** It should be possible to remove the radar information, AIS information and other navigational information by single operator action.

**5.15.36** ECDIS and added navigational information should use a common reference system. If this is not the case, an indication should be provided.

**5.15.37** Transferred radar information may contain a radar image and/ or tracked target information.

**5.15.38** If the radar image is added to the ECDIS display, the chart and the radar image should match in scale, projection and in orientation.

**5.15.39** The radar image and the position from the position sensor should both be adjusted automatically for antenna offset from the conning position.

**5.15.40** It should always be possible to display the SENC information in a "north-up" orientation. Other orientations are permitted (e. g. a "course-up" orientation).

When such orientations are displayed, the orientation should be altered in steps large enough to avoid unstable display of the chart information.

**5.15.41** ECDIS should provide for true motion mode (the ship's symbol moves against non-moving chart background). Other modes are permitted.

**5.15.42** When true motion mode is in use, reset and generation of the chart display of the neighbouring area should take place automatically at own ship's distance from the edge of the display as determined by the mariner.

**5.15.43** It should be possible to manually change the displayed chart area and the position of own ship relative to the edge of the display.

**5.15.44** If the area covered by the ECDIS display includes waters for which no ENC at a scale appropriate for navigation is available, the areas representing those waters should carry an indication

to the mariner to refer to the paper chart or to the RCDS mode of operation.

**5.15.45** IHO recommended colours and symbols should be used to represent SENC information.

**5.15.46** The colours and symbols other than those mentioned in 5.15.45, should comply with the applicable requirements contained in 5.2.

**5.15.47** SENC information displayed at a scale specified in the ENC should use the specified size of symbols, figures and letters recommended by IHO.

**5.15.48** ECDIS should allow the mariner to select whether own ship is displayed in true scale or as a symbol.

**5.15.49** ECDIS should be capable of displaying information for:

- .1 route planning and supplementary navigation tasks; and
- .2 route monitoring.

**5.15.50** The effective size of the chart presentation for route monitoring should be at least 270 × 270 mm.

**5.15.51** The display should be capable of meeting colour and resolution recommendations of IHO.

**5.15.52** The method of presentation should ensure that the displayed information is clearly visible to more than one observer in the conditions of light normally experienced on the bridge of the ship by day and by night.

**5.15.53** If information categories included in the Standard Display are removed to customize the display, this should be permanently indicated. It should be possible to restore the information removed from the Standard Display. Identification of categories which are removed from the Standard Display should be shown on demand.

**5.15.54** It should be possible to carry out route planning and route monitoring in a simple and reliable manner.

**5.15.55** The largest scale data available in the SENC for the area given should always be used by the ECDIS for all alarms or indications of crossing the ship's safety contour and of entering a prohibited area, and for alarms and indications according to Table 5.15.84.

**5.15.56** It should be possible to carry out route planning including both straight and curved segments.

**5.15.57** It should be possible to adjust a planned route alphanumerically and graphically including:

- .1 adding waypoints to a route;
- .2 deleting waypoints from a route;
- .3 changing the position of a waypoint.

**5.15.58** It should be possible to plan one or more alternative routes in addition to the selected route. The selected route should be clearly distinguishable from the other routes.

**5.15.59** An indication is required if the mariner plans a route across an own ship's safety contour.

**5.15.60** An indication should be given if the mariner plans a route closer than a user-specified distance from the boundary of a prohibited area or a geographic area for which special conditions exist. An indication should also be given if the mariner plans a route closer than a user-specified distance from a point object, such as a fixed or floating aid to navigation or isolated danger.

The following are the areas for which special conditions exist:

- Traffic separation zone;
- Inshore traffic zone;
- Restricted area;
- Caution area;
- Offshore production area;
- Areas to be avoided;
- User defined areas to be avoided;
- Military practise area;
- Seaplane landing area;
- Submarine transit lane;
- Anchorage area;
- Marine farm/ aquaculture;
- PSSA (Particularly Sensitive Sea Area).

**5.15.61** It should be possible for the mariner to specify a cross track limit of deviation from the planned route at which an automatic off-track alarm should be activated.

**5.15.62** For route monitoring the selected route and own ship's position should appear whenever the display covers that area.

**5.15.63** It should be possible to display a sea area that does not have the ship on the display (e.g. for look ahead, route planning), while route monitoring. If this is done on the display used for route monitoring, the automatic route monitoring functions (e.g. updating ship's position, and providing alarms and indications) should be continuous. It should be possible to return to the route monitoring display covering own ship's position immediately by single operator action.

**5.15.64** ECDIS should give an alarm if, within a specified time set by the mariner, own ship will cross the safety contour.

**5.15.65** ECDIS should give an alarm or indication, as selected by the mariner, if, within a specified time set by the mariner, own ship will cross the boundary of a prohibited area or of a geographical area for which special conditions exist.

**5.15.66** An alarm should be given when the specified cross track limit for deviation from the planned route is exceeded.

**5.15.67** An indication should be given to the mariner if, continuing on its present course and speed, over a specified time or distance set by the mariner, own ship will pass closer than a user-specified distance from a danger (e. g. obstruction,

wreck, rock) that is shallower than the mariner's safety contour or an aid to navigation.

**5.15.68** The ship's position should be derived from a continuous positioning system of an accuracy consistent with the requirements of safe navigation. Whenever possible, a second independent positioning source, preferably of a different type, should be provided. In such cases ECDIS should be capable of identifying discrepancies between the two sources.

**5.15.69** ECDIS should provide an alarm when the input from position, heading or speed sources is lost. ECDIS should also repeat, but only as indication, any alarm or indication passed to it from position, heading or speed sources.

**5.15.70** An alarm should be given by ECDIS when the ship reaches a specified time or distance, set by the mariner, in advance of a critical point on the planned route.

**5.15.71** The positioning system and the SENC should be on the same geodetic datum. ECDIS should give an alarm if this is not the case.

**5.15.72** It should be possible to display alternative routes in addition to the selected route. The selected route should be clearly distinguishable from the other routes. During the voyage, it should be possible for the mariner to modify the selected route or change to an alternative route.

**5.15.73** It should be possible to display:

**.1** time-labels along a ship's track manually on demand and automatically at intervals selected between 1 and 120 minutes;

**.2** an adequate number of: points, free movable electronic bearing lines, variable and fixed range markers and other symbols required for navigation purposes and specified in 5.15.32.

**5.15.74** It should be possible to enter the geographical co-ordinates of any position and then display that position on demand. Also, it should be possible to select any point (features, symbol or position) on the display and read its geographical co-ordinates on demand.

**5.15.75** It should be possible to adjust the displayed geographical position of the ship manually. This manual adjustment should be noted alpha-numerically on the screen, maintained until altered by the mariner and automatically recorded.

**5.15.76** ECDIS should provide the capability to enter and plot manually obtained bearing and distance lines of position (LOP), and calculate the resulting position of own ship. It should be possible to use the resulting position as an origin for dead-reckoning.

**5.15.77** ECDIS should indicate discrepancies between the position obtained by continuous positioning systems and positions obtained by manual observations.

**5.15.78** ECDIS should store and be able to reproduce certain elements required to reconstruct the navigation and verify the official database used during the previous 12 hours.

The following data should be recorded at one minute intervals:

**.1** to ensure a record of own ship's past track: time, position, heading, and speed; and;

**.2** to ensure a record of official data used: ENC source, edition, date, cell and update history.

In addition, ECDIS should record the complete track for the entire voyage, with time marks at intervals not exceeding 4 hours.

It should not be possible to manipulate or change the recorded information.

**5.15.79** ECDIS should have a capability to preserve the record of the previous 12 hours and of the voyage track.

**5.15.80** The accuracy of all calculations performed by ECDIS should be independent of the characteristics of the output device and should be consistent with the SENC accuracy.

**5.15.81** Bearings and distances drawn on the display or those measured between features already drawn on the display should have accuracy no less than that afforded by the resolution of the display.

**5.15.82** The ECDIS system should be capable of performing and presenting the results of at least the following calculations:

**.1** true distance and azimuth between two geographical positions;

**.2** geographical position from known position and distance/ azimuth;

**.3** geodetic calculations such as spheroidal distance, rhumb line, and great circle.

**5.15.83** ECDIS should be provided with means for either automatically or manually carrying out on-board tests of major functions. In case of a failure, the test should display information to indicate which module is at fault.

**5.15.84** ECDIS should provide a suitable alarm or indication of system malfunction, the minimum scope of requirements to which is given in Table 5.15.84.

**5.15.85** ECDIS should not degrade the performance of any equipment providing sensor inputs. Nor should the connection of optional equipment degrade the performance of ECDIS below this standard.

**5.15.86** ECDIS should be connected to the ship's position fixing system, to the gyro compass and to the speed and distance measuring device. For ships not fitted with a gyro compass, ECDIS should be connected to a marine transmitting heading device.

**5.15.87** ECDIS may provide a means to supply SENC information to external equipment.

**5.15.88** It should be possible to operate ECDIS and all equipment necessary for its normal functioning when supplied by a main and an emergency source of electrical power.

**5.15.89** Changing from one source of power supply to another or any interruption of the supply for a period of up to 45 seconds should not require the equipment to be manually re-initialized.

**5.15.90** Adequate back-up arrangements should be provided to ensure safe navigation in case of an ECDIS failure.

**.1** Facilities enabling a safe take-over of the ECDIS functions should be provided in order to ensure that an ECDIS failure does not develop into a critical situation.

Table 5.15.84

| Section  | Requirements        | Information   |
|--|---------------------|---|
| 5.15.64  | Alarm*              | Crossing safety contour                                     |
| 5.15.65  | Alarm or indication | Area with special conditions                                |
| 5.15.66  | Alarm               | Deviation from route  |
| 5.15.69  | Alarm               | Positioning system failure (loss of signal from the system) |
| 5.15.70  | Alarm               | Approach to critical point                                  |
| 5.15.71  | Alarm               | Different geodetic datum                                    |
| 5.15.84  | Alarm or indication | Malfunction of ECDIS  |
| 5.15.28.3  | Indication**        | Default safety contour                                      |
| 5.15.33.1  | Indication          | Information overscale                                       |
| 5.15.33.2  | Indication          | Larger scale ENC available                                  |
| 5.15.35  | Indication          | Different reference systems                                 |
| 5.15.44  | Indication          | No ENC available  |
| 5.15.53  | Indication          | Customized display  |
| 5.15.59  | Indication          | Route planning across safety contour                        |
| 5.15.60  | Indication          | Route planning across specified area                        |
| 5.15.64  | Alarm               | The ship is crossing safety contour                         |
| 5.15.67  | Indication          | Crossing a danger in route monitoring mode                  |
| 5.15.83  | Indication          | System test failure   |
| * Alarm — an alarm or alarm system which announces by audible means, or audible and visual means, a condition requiring attention. |                     |   |
| ** Indication — visual indication giving information about the condition of a system or equipment.                                 |                     |   |

**.2** A back-up arrangement should provide means of safe navigation for the remaining part of a voyage in case of an ECDIS failure.

**5.15.91** The back-up system should display in graphical (chart) form the relevant information of the hydrographic and geographic environment which are necessary for safe navigation.

**5.15.92** The back-up system should be capable of performing the route planning functions, including:

**.1** taking over the route plan originally performed on the ECDIS;

**.2** adjusting a planned route manually or by transfer from a route planning device.

**5.15.93** The back-up system should enable a take-over of the route monitoring originally performed by the ECDIS, and provide at least the following functions:

**.1** plotting own ship's position automatically, or manually on a chart;

**.2** taking courses, distances and bearings from the chart;

**.3** displaying the planned route;

**.4** displaying time labels along ship's track;

**.5** plotting an adequate number of points, bearing lines, range markers, etc., on the chart.

**5.15.94** If the back-up is an electronic device, it should be capable of displaying at least the information equivalent to the standard display as defined in this performance standard.

**5.15.95** The chart information to be used in the backup arrangements should be the latest edition, as corrected by official updates, of that issued by or on the authority of a Government, authorized Hydrographic Office or other relevant government institution, and conform to IHO standards.

It should not be possible to alter the contents of the electronic chart information.

The chart or chart data edition and issuing date should be indicated.

**5.15.96** The information displayed by the ECDIS back-up arrangements should be up-to-date for the entire voyage.

**5.15.97** If an electronic device is used, it should provide an indication if:

**.1** the information is displayed at a larger scale than that contained in the database;

**.2** own ship's position is covered by a chart at a larger scale than that provided by the system.

**5.15.98** If radar and other navigational information are added to an electronic back-up display, all the corresponding requirements for radar information and other navigation information of this performance standard should be met.

If an electronic device is used, the display mode and generation of the neighbouring area should be in accordance with 5.15.40 — 5.15.44.

**5.15.99** The back-up arrangement should be able to keep a record of the ship's actual track, including positions and corresponding times.

**5.15.100** The back-up arrangement should provide reliable operation under prevailing environmental and normal operating conditions.

**5.15.101** Accuracy should be in accordance with requirements from sections 5.15.80 — 5.15.82.

**5.15.102** If an electronic device is used, it should provide a suitable alarm or indication of system malfunction.

**5.15.103** If an electronic device is used, it should be designed in accordance with the ergonomic principles of ECDIS.

**5.15.104** If an electronic device is used, colours and symbols should be in accordance with the colours and symbols requirements of ECDIS, and the effective size of the chart presentation should be not less than 250 × 250 mm or 250 mm diameter.

**5.15.105** The back-up power supply of an electronic device should be separate from the ECDIS.

**5.15.106** If an electronic device is used, it should be connected to systems providing continuous position-fixing capability and not degrade the performance of any equipment providing sensor input.

**5.15.107** If radar with selected parts of the ENC chart information overlay is used as an element of the back-up, the radar should comply with requirements of section 5.7.

**5.15.108** If ECDIS is used for displaying raster navigation charts (Raster Chart Display System - RCDS) the performance standards specified in this Chapter should be followed with the exception of 5.15.20, 5.15.22, 5.15.26 — 5.15.29, 5.15.47, 5.15.51, 5.15.53, 5.15.55, 5.15.59, 5.15.60, 5.15.64, 5.15.65 and 5.15.67.

**5.15.108.1** When operating in RCDS-mode, an appropriate portfolio of up-to-date paper charts (APC) should be carried on board and be readily available to the mariner.

The APC is a suite of paper charts of a scale to show sufficient detail of topography, depths, navigational hazards, aids to navigation, charted routes, and routing measures to provide the mariner with information on the overall navigational environment.

The APC should provide adequate look-ahead capability.

**5.15.108.2** The RNC used in RCDS should be of the latest edition of that originated by, or distributed on the authority of, a government authorized hydrographic office and conform to IHO standards. RNCs not on WGS-84 or PE-90 should carry meta-data (i.e., additional data) to allow geo-referenced positional data to be displayed in the correct relationship to SRNC data.

**5.15.108.3** The contents of the SRNC should be adequate and up-to-date for that part of the intended voyage not covered by ENC.

**5.15.108.4** It should not be possible to alter the contents of the RNC.

**5.15.108.5** RCDS should be capable of displaying all SRNC information.

**5.15.108.6** SRNC information available for display during route planning and route monitoring should be subdivided into two categories:

**.1** the RCDS standard display consisting of RNC and its updates, including its scale, the scale at which it is displayed, its horizontal datum, and its units if depth and heights;

**.2** any other information such as mariner's notes.

**5.15.108.7** It should be easy to add to, or remove from the RCDS display any information additional to the RNC data, such as mariner's notes. It should not be possible to remove any information from the RNC.

**5.15.108.8** There should always be an indication if the ECDIS equipment is operating in RCDS mode.

**5.15.108.9** It should always be possible to display the SRNC in "chart-up" orientation. Other orientations are permitted.

**5.15.108.10** IHO recommended colours and symbols should be used to represent SRNC information.

**5.15.108.11** RCDS should be capable of displaying, simply and quickly, chart notes which are not located on the portion of the chart currently being displayed.

**5.15.108.12** It should be possible for the mariner to enter points, lines and areas which activate an automatic alarm. The display of these features should not degrade the SRNC information and it should be clearly distinguishable from the SRNC information.

**5.15.108.13** It should be possible to display a sea area that does not have the ship on the display (e.g. for look ahead, route planning), while route monitoring. If this is done on the display used for route monitoring, the automatic route monitoring functions in 5.15.63 should be continuous. It should be

possible to return to the route monitoring display covering own ship's position immediately by single operator action.

**5.15.108.14** The RCDS should only accept positional data referenced to the WGS 84 or PE-90 Geodetic Datum. RCDS should give an alarm if the positional data is not referenced to one of these datum. If the displayed RNC cannot be referenced to the WGS 84 or PE-90 datum then a continuous indication should be provided.

**5.15.108.15** RCDS should allow the user to manually align the SRNC with positional data. This can be necessary, for example, to compensate for local charting errors.

**5.15.108.16** It should be possible to activate an automatic alarm when the ship crosses a point, line, or is within the boundary of a mariner entered feature within a specified time or distance.

**5.15.108.17** RCDS should be capable of performing transformations between a local datum and WGS 84 Datum.

**5.15.108.18** RCDS should provide a suitable alarm or indication of system malfunction, the minimum scope of requirements to which is given in Table 5.15.108.18.

## 5.16 HEADING CONTROL SYSTEM

**5.16.1** The heading control system shall enable the ship to keep a preset heading with minimum operation of the ship's steering gear.

**5.16.2** The heading control system shall automatically keep the ship on a preset heading with an accuracy at which an average heading value may differ from the preset value not more than by  $\pm 1^\circ$  at a speed providing ship's normal manoeuvrability. The maximum amplitude of yaw shall not exceed that allowed under manual control.

**5.16.3** The heading control system may be able to perform turns based either on a preset turning radius or a preset rate of turn.

Table 5.15.108.18

| Paragraph  | Requirement         | Information  |
|--|---------------------|--|
| 5.15.66  | Alarm               | Deviation from route                                     |
| 5.15.108.16  | Alarm               | Approach to mariner entered feature, e.g. area, line     |
| 5.15.69  | Alarm               | Position system failure (loss of signal from the system) |
| 5.15.70  | Alarm               | Approach to critical point                               |
| 5.15.71  | Alarm or indication | Different geodetic datum                                 |
| 5.15.84  | Alarm or indication | Malfunction of RCDS mode                                 |
| 5.15.108.8   | Indication          | ECDIS operating in the raster mode                       |
| 5.15.33.1  | Indication          | Larger scale information available, or overscale         |
| 5.15.33.2  | Indication          | Larger scale RNC available for the area of the vessel    |
| The definitions of alarms and indicators are given in note to Table 5.15.84. |                     |  |

The heading control system may work together with a track control system adjusting its heading for total drift.

**5.16.4** The heading control system shall change to a preset heading without significant overshoot (yaw).

**5.16.5** Provision shall be made in the heading control system for manual change of the heading in the automatic mode without change-over to manual steering.

Two remote stations for manual steering are recommended for the heading control system to make possible an emergency change of the ship's heading from these stations when the system operates in the automatic mode. A single change in the ship's heading in either direction shall not be limited, up to a complete turning. The design of the remote stations for manual steering shall be such that after putting the manual control at the station in the neutral position the ship shall keep the preset heading and further operation of the system in the automatic mode shall be maintained.

The steering wheel, handle or push-button may be used as a manual control.

**5.16.6** A repeater of the gyrocompass or magnetic compass, indicators of the rudder preset and true positions, controls for switching on power supply to the entire heading control system and steering gear motors, sensitivity switches and steering mode change-over controls, controls for presetting ship's turning radius or rate of turn, signal lamps and other controls required for operation of the system shall be installed on the control desk of the system.

It shall be possible to vary illumination of the controls and indicators installed on the control desk of the system.

**5.16.7** The heading control system shall be capable of adapting manually or automatically to different steering characteristics of the ship under various speed and loading conditions depending on weather, and to provide reliable operation under normal operating conditions.

**5.16.8** The heading control system shall prevent unnecessary activation of the rudder due to normal yaw motion in a seaway and enable to preset the maximum rudder angle with indication when the angle of limitation has been reached.

**5.16.9** Any inadvertent alteration of the preset heading shall be prevented.

**5.16.10** The system shall enable change-over from automatic to manual steering and vice versa by a single control located in an easily accessible position. The following requirements shall be met:

**.1** change-over shall be possible at any position of the rudder, including any failure in the automatic control system;

**.2** change-over shall be effected by one manual control within 3 s;

**.3** adequate indication shall be provided to show which method of steering is in operation.

**5.16.11** When changing over from manual to automatic control the heading control system shall take over the actual heading as the preset heading.

**5.16.12** If the heading control system works as part of a track control system, then switching from track control to automatic heading control shall be provided in the event of any failure in the track control system. The actual heading at the moment of switching shall be taken as the preset heading.

Any inadvertent switching back to track control shall be prevented.

**5.16.13** The heading control system shall be totally self-synchronizing and shall not require any adjustments when a steering mode is changed-over.

The manual steering system built-in the control desk of the heading control system shall be simple, reliable and not use elements of the automatic steering system and shall also provide follow-up mode of the system operation.

**5.16.14** An alarm both audible with mute function and visual shall be provided in order to indicate failure or reduction in the power supply to the heading control system or heading monitor, as well as when the actual heading deviates from the preset heading beyond a preset limit.

**5.16.15** In case two independent compasses are available, the following shall be provided:

**.1** an alarm both audible with mute function and visual when the pre-set value of permissible discordance between readings of operating and back-up heading monitors is reached;

**.2** a clear indication on the actual heading source.

The heading monitor may be a separate device and is not required to be an integral part of the heading control system.

**5.16.16** The heading control system shall provide an alarm on a failure of any information sensor used in the steering process. All emergency alarms likely to be activated in connection with sensor operation shall be duplicated on the control desk of the heading control system.

**5.16.17** Where the system is not capable for adapting automatically to different environmental conditions and steering characteristics, adequate means for manual adjustments shall be provided on the front panel of the system control desk.

**5.16.18** Normal alterations of heading shall be possible by adjustment of one control only (steering wheel, handle, push-button):

**.1** alteration of the preset heading to starboard shall be effected by turning the heading setting control clockwise or titling it to the right-hand side.

**.2** alteration of the present heading to port side shall be effected by turning the heading setting



control counter-clockwise or tilting it to the left-hand side. Actuation of any other control shall affect the preset heading of the ship.

**5.16.19** Where remote control stations are provided, facilities for the delegation of control to remote station shall be incorporated in the master station.

Controls at remote positions shall be similar to those on the master station and have illumination which may be varied as required by 5.16.6.

**5.16.20** Provision shall be made for connection of the heading control system with suitable source of speed information.

Connection of the heading control system with information sources shall comply with 5.1.31.

### 5.17 SHIP'S TRACK CONTROL SYSTEM

**5.17.1** The ship's track control system in conjunction with their sensors of position, heading and speed information shall, regarding manoeuvring characteristics, provide automatic keeping a ship on a pre-planned track over ground under various operational conditions and at ship's speed from minimum manoeuvring speed up to 30 knots, and at ship's rate of turn not greater than  $10^\circ/s$ .

**5.17.2** A track control system shall be automatically able to steer the ship from her position to a preset waypoint or along a preset sequence of waypoints.

**5.17.3** The system shall allow the watch navigator to start automatic track control only if the safe approach manoeuvre to the pre-set track is provided by the following:

- .1 the ship's position;
- .2 the difference between track course and actual heading;
- .3 ship's manoeuvrability.

**5.17.4** The radio and navigation systems receiver used by the ship's track control system shall meet requirements in 5.11.

**5.17.5** Means shall be provided for continuous monitoring the ship's position by another independent positioning system.

**5.17.6** When following along the pre-set sequence of waypoints, an alarm shall be given not later than 1 min before the course change and at the moment of manoeuvre starting.

**5.17.7** The ship's track control system shall provide means for the watch navigator to confirm the course change at wheel-over. Without the confirmation, the ship shall follow automatically the pre-set track.

An alarm actuation shall be provided if a wheel over alarm was not confirmed within 30 s.

**5.17.8** A sequence of waypoints of a pre-set track shall not be modified until:

- .1 the pre-planning of the new track is completed; and
- .2 the requirements of 5.17.3 are fulfilled.

**5.17.9** The track control system shall ensure the automatic manoeuvre of the ship when sailing from one leg of a pre-set track to another basing:

- .1 on a pre-set turn radius;
- .2 on a pre-set rate of turn and manoeuvrability of the ship.

**5.17.10** The ship's track control system shall provide its adaptation (manual or automatic) to different steering characteristics of the ship under various weather, speed and loading conditions, and also ensure reliable functioning in service.

**5.17.11** The ship's track control system may be operated in heading control mode. In this case, the requirements in 5.16 shall be fulfilled.

When changing over from track control to heading control, the actual heading shall be taken over by the system as the pre-set heading.

Changing over of system functioning modes shall be performed by a single operator action from the convenient and readily accessible position.

A possibility of changing the system functioning modes by chance shall be excluded.

Clear indication on the system control panel shall be provided to show which method of ship's steering is in operation.

**5.17.12** The system shall provide the change over from track control to manual steering and back by a single operator action from the convenient and readily accessible position. In this case the following requirements shall be fulfilled:

- .1 possibility of change over at any rudder angle and under any conditions including failure in the automatic steering system;
- .2 carrying out the change over by a single action within time not exceeding 3 s;
- .3 provision of clear indication on the system control panel of functioning mode in use.

A possibility of return to ship's track control mode by chance shall be excluded.

**5.17.13** When changing over from manual steering to automatic steering, the system shall ensure bringing the ship to the pre-set track.

**5.17.14** The separate or built-in repeater shall be provided to indicate the actual value of ship's heading.

**5.17.15** An audible alarm, that can be cancelled, and a visual one shall be provided to warn about failure or reduction in power supply of the ship's track control system and of the course indication system, and also about an excess of a pre-set values of the ship's permissible deviation from a pre-set track

or course depending on the system functioning mode in use.

**5.17.16** The ship's track control system shall provide:

**.1** an alarm with an acknowledgement function in case of failure or fault of the position fixing and course indication system;

**.2** a preparation of guidance for changing over to a safe steering mode.

An actuation of an alarm shall be provided if warning signal about fault or failure of the position fixing and course indication systems was not acknowledged within 30 s.

It shall not be possible for the system to use information from faulty sensors.

**5.17.17** The system shall provide an alarm in case when:

**.1** the actual position of the ship deviates from the pre-set track beyond a pre-set cross track limit;

**.2** the ship's speed through the water is lower than a predefined limit necessary for steering the ship.

**5.17.18** The track control system shall provide a possibility to calculate heading between subsequent pre-set waypoints, and also a turn radius or rate of turn. In this case the system shall regard all pre-set track control related limits, conditions of alarm actuation and other ship's steering parameters.

**5.17.19** The following information shall be continuously displayed on the system control panel:

**.1** mode of ship's steering (heading or track control);

**.2** sensors of actual position of the ship, its heading and speed;

**.3** status and failure of sensors;

**.4** track course and actual heading;

**.5** actual ship's position, cross track distance and speed;

**.6** TO-waypoint (waypoint which the ship is approaching) and NEXT-waypoint (waypoint following the TO-waypoint);

**.7** time and distance to TO-waypoint;

**.8** calculated track course following turn performance;

**.9** selected track identification.

Items 5.17.19.4, 5.17.19.5, 5.17.19.7 and 5.17.19.8 shall be displayed numerically.

**5.17.20** The following information shall be provided on demand:

**.1** a list of pre-planned waypoints including waypoints numbers, co-ordinates, courses and distances between waypoints, calculated turn radii or rates of turn;

**.2** all track control related pre-set limits and other steering parameters. In this case, functionally related values (such as pre-set and actual, etc.) shall be displayed as a pair of data.

**5.17.21** In case of failure of the track control mode or the position fixing system in use, the track control system shall:

**.1** automatically switch over to the heading control mode if it is available. In doing so the actual heading at the instant of switching over shall be taken as the pre-set heading;

**.2** maintain the rudder angle if the heading control is not available.

**5.17.22** In case of the course indication system failure, the track control system shall ensure actuating alarms required in 5.17.15 to 5.17.17 and maintaining the rudder angle.

#### 5.18 UNIVERSAL SHIPBORNE AUTOMATIC IDENTIFICATION SYSTEM (AIS)

**5.18.1** The universal shipborne automatic identification system (AIS) shall be capable of operating in the following modes:

**.1** an autonomous mode for operation in all areas of the ship's service ensuring continuous automatic self organizing mutual exchange of static and dynamic (navigational) information between ships and between ships and shore-based stations. This mode shall be capable of being switched to/from one of the following alternate modes;

**.2** an assigned mode for operation in an area subject to a competent authority responsible for traffic monitoring such that the static and dynamic information transmission interval and time slots may be set by that authority and/or scheduled;

**.3** a polling mode for automatic transfer of static and dynamic information, as well as voyage related information in response to interrogation from a ship or competent authority.

**5.18.2** For the purpose of identification, the Maritime Mobile Service Identity (MMSI) number assigned to the ship shall be used in the AIS.

**5.18.3** The AIS shall comprise:

**.1** a communication processor, capable of operating over a range of maritime frequencies, with an appropriate channel selecting and switching method, in support of both short (VHF) and long range applications;

**.2** at least one transmitter, two time-division multiple access (TDMA) receivers using a universal time scale, and one digital selective call (DSC) receiver tuned to Maritime Mobile Service's VHF channel 70;

**.3** a means of processing data from an electronic position-fixing system which provides a resolution of one ten thousandth of a minute of arc and uses the WGS-84 datum;

**.4** a means to automatically input data from the dynamic information sensors;

- .5 a minimum keyboard and display (MKD) to enable manual input, updating and retrieving of data;
- .6 a means of error checking the transmitted and received data;
- .7 built-in test equipment;
- .8 internal Global Navigational Satellite System (GNSS) receiver to determine the Universal Coordinated Time (UTC) for synchronization purposes.

**5.18.4** The AIS shall be capable of:

- .1 providing the ship's manoeuvring and positional information (dynamic information) at intervals specified in Table 5.18.17;
- .2 providing static information periodically and automatically to a competent authority and other ships fitted with AIS;
- .3 receiving and processing information from a competent authority and other ships;
- .4 responding to high priority or safety related calls with a minimum of delay.

Additionally, in the event of failure of the main source of ship's positional information, it is recommended to provide for automatic switching to the internal Global Navigational Satellite System receiver for positional information. In this case, an appropriate built-in integrity tests (BIIT) indication shall be output and the position data shall be continuously available on the minimum display.

**5.18.5** The AIS shall be capable of operating in the VHF frequency band of Maritime Mobile Service (156,025 MHz to 162,025 MHz) with the frequency spacing between 25 kHz and 12,5 kHz channels.

After switching on, the AIS shall by default be capable of operating on two international simplex channels: AIS 1 – 161,975 MHz (channel 2087), AIS 2 to 162,025 MHz (channel 2088).

The AIS shall be capable of switching over to other channels by one of the following three methods:

- .1 manual switching;
- .2 automatic switching as required by shore-based station in the TDMA format;
- .3 automatic switching as required by shore-based station in the DSC format.

**5.18.6** The AIS shall be capable of transmitting and receiving the following information:

- .1 static:
  - IMO number assigned to the ship;
  - call sign and name;
  - length and beam;
  - type of ship;
  - location of position-fixing antenna on the ship (aft of bow and port or starboard of centerline);
- .2 dynamic:
  - ship's position with accuracy indication and integrity status;
  - time in UTC;
  - course over ground (COG);

- speed over ground (SOG);
- heading (according to gyrocompass);
- rate of turn (where rate of turn indicator is available);
- navigational status (underway, at anchor, not under command (NUC), limited freedom to manoeuvre, at berth, grounded, trawling, etc. — manual input);
- .3 voyage related:
  - ship's draught;
  - hazardous cargo and its type (as required by a competent authority);
  - destination and estimated time of arrival (ETA) (at master's discretion);

The name of the port of destination shall comply with the International Code — UN/LOCODE;

.4 safety-related messages (short messages relevant to maritime safety and containing important navigational and meteorological notices).

**5.18.7** In the autonomous mode, the AIS shall be capable of transmitting information at the following intervals, depending on the information type and the ship's navigational status:

- .1 static information:
  - every 6 min;
  - on request;
- .2 dynamic information: dependant on the navigational status of own ship according to Table 5.18.7;

Table 5.18.7

| Ship's navigational status                                      | Dynamic information reporting interval |
|---|--|
| Ship at anchor or moored and not moving faster than 3 knots     | 3 min                                  |
| Ship at anchor or moored and moving faster than 3 knots         | 10 s                                   |
| Ship with a speed of between 0 to 14 knots                      | 10 s                                   |
| Ship with a speed of between 0 to 14 knots and changing course  | 3,3 s                                  |
| Ship with a speed of between 14 to 23 knots                     | 6 s                                    |
| Ship with a speed of between 14 to 23 knots and changing course | 2 s                                    |
| Ship with a speed of greater than 23 knots                      | 2 s                                    |
| Ship with a speed of greater than 23 knots and changing course  | 2 s                                    |

- .3 voyage-related information:
  - every 6 min;
  - when data have been amended;
  - on request;
- .4 safety-related messages:
  - as required.

The AIS shall be able to handle up to 4,500 reports per min when operating on two channels.

**5.18.8** The input and transmitted data shall be protected against unauthorized alteration.

**5.18.9** The AIS installation shall be operational within 2 min of switching on.

**5.18.10** Means shall be provided to automatically record all periods when the AIS installation is non-functioning in a non-volatile memory.

**5.18.11** The minimum keyboard and display (MKD) of the AIS shall comply with the following requirements:

**.1** display of at least 3 lines of data. Each line shall clearly display at least the ships' name, bearing and range;

**.2** horizontal scrolling of bearing and range is not allowed;

**.3** the displayed information shall be clearly visible under all possible conditions of illumination at the place where it is located. Where needed, display lighting shall be provided;

**.4** provision shall be made for manual input of voyage-related information and safety-related messages;

**.5** provision shall be made for displaying the alarms information, indications as a result of built-in integrity test, received safety related messages and received long range interrogations.

#### 5.19 SOUND RECEPTION SYSTEM

**5.19.1** The sound reception system shall be capable of receiving outside sound signals from all directions in the audio band 70 Hz to 820 Hz, of reproducing those signals acoustically inside the wheelhouse indicating therewith the direction of the sound signals source.

**5.19.2** The volume of outside sound signals reproduced in the wheelhouse shall be adjusted. In this case, the minimum sound pressure level shall be 10 dB(A) above the bridge noise level.

**5.19.3** The visual indicator of a sound signals reception system shall indicate a direction not later than in 3 s after reception of the incoming sound signal by the system.

#### 5.20 VOYAGE DATA RECORDER (VDR)

**5.20.1** The voyage data recorder shall continuously and automatically record devices and systems readings relating to the status and ship's equipment operational modes, command and control of the ship, and environment.

**5.20.2** The method of recording shall provide a possibility to determine the recording date and time during playback on suitable equipment.

**5.20.3** The recorded data medium shall be installed in a protective capsule which meets the following requirements:

be capable to continue data recording during accident;

be secure against tampering with data recorded; provision of survival and a possibility of withdrawal after any accident;

bright colour and retro-reflective marking.

The device to aid location of the float-free type protective capsule, after being automatically switched on, shall be capable of transmitting signals for at least:

48 hours — an initial locating signal;

168 hours — a locating homing signal.

**5.20.3.1** The protective capsule shall be designed to remain fixed to the external deck of the vessel. Alternatively, it may be designed to float free automatically.

**5.20.3.2** The protective capsule shall be designed to protect the stored data against the following:

**.1** shock (a half sine-wave pulse of 50 g, with a duration of 11 ms);

**.2** penetration (a mass of 250 kg with a pin of 100 mm diameter, dropped from a height of 3 m);

**.3** low temperature fire of 260 °C nominal for 10 h;

**.4** high temperature fire of 1 100 °C nominal for 1 h;

**.5** 3 m sea water immersion for 30 days;

**.6** 6000 m deep-sea water immersion for 24 h.

**5.20.3.3** All protective capsules irrespective of their design shall include an acoustic underwater beacon operating in the frequency band of 25 kHz to 50 kHz with battery life of at least 30 days and marked with a clearly seen legend in English:

"VOYAGE DATA RECORDER — DO NOT OPEN — REPORT TO AUTHORITIES".

**5.20.3.4** In the case of a protective capsule intended for float-free operation it shall have a suitable light and a radio transmitter capable of transmitting signals for location purposes. The battery life for both the radio and light functions shall be at least seven days.

**5.20.4** It shall be possible to record, as a minimum, the following data items:

**.1** date and time in steps ensuring a reconstruction of events sequence. Date and time referenced to UTC shall be obtained from a source external to the ship or from a clock built into a recorder with indication, which source is in use;

**.2** latitude and longitude of ship's position obtained from a receiver of radio navigation systems with indication of its type and operational mode, as well as the datum used;

**.3** ship's heading as indicated by the ship's gyro-compass or magnetic compass;

**.4** ship's speed as indicated by the ship's log including an indication if it is through the water or over the ground;

**.5** conversations, commands and sound signals on the bridge and also, if possible, announcements over intercom and public address systems;

**.6** communications with other ships, objects and shore-based services using VHF radio equipment;

**.7** radar and auxiliary navigational data displayed on the radar display unit. The recording method shall ensure a possibility to playback an image as it was during recording regarding possible distortions connected with data compression during recording;

**.8** depth under the ship's keel with indication of the depth scale currently being displayed and of the operational mode of an echo sounder;

**.9** all incoming alarms on the bridge;

**.10** commands coming to a steering gear, their execution, and also an operational mode of a heading or track control system;

**.11** commands coming to an engine room, their execution, and also an operational mode of thrusters (if any);

**.12** status of sea openings of the ship's hull required to be displayed on the bridge;

**.13** watertight and fire doors status;

**.14** accelerations and hull stresses (if suitable sensors are available);

**.15** wind speed and direction (if suitable sensors are available).

**5.20.5** It may be possible to record other additional information. In this case, recording of additional data shall not distort main data or affect their preservation.

**5.20.6** The voyage data recorder shall provide recording and storage of information of the previous at least 12 h of a voyage.

**5.20.7** Provision shall be made for recording attempts of an unauthorized access to recorder operation.

**5.20.8** The recording method shall provide an actuation of alarm when a non-correctable error is detected during recording.

**5.20.9** If the ship's source of electric power supply fails, the voyage data recorder shall continue to record bridge audio for a period of 2 h using its own accumulator batteries. At the end of this 2 h period all recording shall cease automatically.

**5.20.10** Malfunctions or failure of a voyage data recorder shall not affect the operation of the data sensors interfaced thereto.

**5.20.11** The VDR should provide an interface for downloading the stored data and playback the information to an external computer. The interface should be compatible with an internationally recognized format, such as Ethernet, USB, Fire Wire or equivalent.

**5.20.12** A copy of the software programme providing the capability to download the stored data and playback the information onto a connected external laptop computer and for the playback of the data should be provided for each VDR installation.

The software should be compatible with an operating system available with commercial-off-the-shelf laptop computers and provided on a portable storage device such as CD-ROM, DVD, USB-memory stick, etc.

**5.20.13** Instructions for executing the software and for connecting the external laptop computer to the VDR should be provided.

**5.20.14** The portable storage device containing the software, the instructions and any special (not commercial-off-the-shelf) parts necessary for the physical connection of the external laptop computer, should be stored within the main input of the VDR.

**5.20.15** Where non-standard or proprietary formats are used for storing the data in the VDR, the software for converting the stored data into open industry standard formats should be provided on the portable storage device or resident in the VDR.

## 5.21 SIMPLIFIED VOYAGE DATA RECORDER (S-VDR)

**5.21.1** The simplified voyage data recorder (S-VDR) shall continuously and automatically maintain sequential record of preselected data items obtained from the ship devices and systems, relating to the status and operational modes of the ship's equipment, command and control of the ship and environment. The recorded data shall be maintained for a period of at least 2 years following termination of recording.

**5.21.2** The method of recording shall ensure that the various data items can be co-related in date and time during playback on suitable equipment.

**5.21.3** The final recording medium shall be installed in a protective capsule, which may be fixed to the open deck of the ship or be of float-free type and shall meet the following requirements:

be capable to continue data recording during accident and of being accessed and of maintaining the recorded data;

be secure against tampering with data recorded;

be of a highly visible colour and marked with retro-reflective material;

be fitted with an appropriate device to aid location;

be marked with clearly seen inscription in English:

"VOYAGE DATA RECORDER — DO NOT OPEN — REPORT TO AUTHORITIES".

**5.21.4** The special protective capsule designed to be fixed to open deck shall comply with all the requirements of 5.21.3 with the exception of the requirements for withstanding penetration (pin dropping). An acoustic underwater beacon ensuring location of the protective capsule shall operate in the frequency band of 25 to 30 Hz with battery life at least 30 days.

**5.21.5** The float-free type special protective capsule shall be fitted with means to facilitate grappling and recovery, after free ascent thereof, and meet the applicable requirements (as they relate to the mechanical and climatic effects) for the emergency position-indicating radio beacons defined in 9.1, Part IV "Radio Equipment". The device ensuring location of the float-free type protective capsule, after being automatically switched on, shall be capable of transmitting signal for at least:

- 48 hours — an initial locating signal;
- 168 hours — a locating homing signal.

**5.21.6** It shall be possible to record, as a minimum, the following data items:

- date and time in steps ensuring a reconstruction of events sequence. Date and time referenced to UTC, may be obtained from a source external to the ship or from an internal clock with indication, which source is in use;

- latitude and longitude of ship's position obtained from a receiver of radio navigation systems with indication of its type and operational mode, as well as the datum used;

- ship's speed as indicated by the ship's log including an indication if it is through the water or over the ground;

- ship's heading as indicated by the ship's gyro-compass or magnetic compass;

- conversations, commands and sound signals on the bridge and also, if possible, announcements over intercom and command broadcast apparatus;

- communications with other ships and objects using VHF radio equipment;

- radar and auxiliary navigational data displayed on the radar display unit. The recording method shall ensure the possibility to playback an image as it was during recording regarding possible distortions connected with data compression during recording. If radar data is recorded, AIS information may be recorded additionally as a secondary source of information on both other and own ship;

- if it is technically impossible to connect the radar installed on board ship to the simplified voyage data recorder, then the AIS target data shall be recorded as a source of information regarding both own and other ships.

**5.21.7** It may be possible to record other additional information derived from the items of

ship's equipment listed in 5.21.4 and having appropriate outputs to provide the possibility of interfacing these items to S-VDR. In this case, recording of additional data shall not distort main data or affect their preservation.

**5.21.8** It shall not be possible to tamper with the selection of data being recorded nor the data, which has already been recorded. Any attempt of an unauthorised access to S-VDR operation shall be recorded.

**5.21.9** The recording method shall provide an actuation of alarm when a non-correctable error is detected during recording.

**5.21.10** The simplified voyage data recorder shall provide recording and storage of information of at least previous 12 hours of a voyage.

**5.21.11** If the ship's source of electric power supply fails, the simplified voyage data recorder shall continue to record bridge audio for a period of 2 hours using its own accumulator batteries. At the end of this 2-hour period, all recording shall cease automatically.

**5.21.12** Any interfacing to any data sensor shall be such that the operation of that sensor suffers no deterioration, even if the S-VDR system develops faults.

**5.21.13** The S-VDR should provide an interface for downloading the stored data and playback the information to an external computer. The interface should be compatible with an internationally recognized format, such as Ethernet, USB, Fire Wire or equivalent.

**5.21.14** A copy of the software programme providing the capability to download the stored data and playback the information onto a connected external laptop computer and for the playback of the data should be provided for each S-VDR installation.

The software should be compatible with an operating system available with commercial-off-the-shelf laptop computers and provided on a portable storage device such as CD-ROM, DVD, USB-memory stick, etc.

**5.21.15** Instructions for executing the software and for connecting the external laptop computer to the S-VDR should be provided.

**5.21.16** The portable storage device containing the software, the instructions and any special (not commercial-off-the-shelf) parts necessary for the physical connection of the external laptop computer, should be stored within the main input of the S-VDR.

**5.21.17** Where non-standard or proprietary formats are used for storing the data in the VDR, the software for converting the stored data into open industry standard formats should be provided on the portable storage device or resident in the S-VDR.

## 5.22 BRIDGE NAVIGATIONAL WATCH ALARM SYSTEM (BNWAS)

**5.22.1** The BNWAS shall monitor the functioning of the main conning position and identify the watch officer unfitness, which may result in accident.

The system shall give visual and audible alarms to warn the watch officer and, if ignore, shall alert the ship's master or back-up officer.

**5.22.2** Provisions shall be made for three functioning modes of the watch officer fitness verification system:

**.1** automatic mode to ensure the automatic activation of the system, when the heading or track control system functions in an automatic mode, and the automatic deactivation of the system when the automatic functioning of the heading or track control system terminates;

**.2** continuous mode of functioning;

**.3** total deactivation mode when, under any conditions, the system does not function.

**5.22.3** When activated, the BNWAS shall give visual and audible alarms in the following sequence:

**.1** immediately after the activation, the system shall remain dormant for a period 3 to 12 min set by the ship's master, where upon the visual alarm shall be actuated;

**.2** if the receipt of the visual alarm is not acknowledged by the watch officer within 15 s, the system shall initiate the first stage audible alarm on the bridge;

**.3** if the receipt of the first stage audible alarm is not acknowledged by the watch officer within 15 s since its actuating on the bridge, the second stage audible alarm shall additionally be activated in the back-up officer or ship's master accommodation;

**.4** if the second stage audible alarm is not acknowledged by the watch officer, back-up officer or ship's master within 90 s since its actuating, the third stage audible alarm shall be activated in all the spaces of officers' accommodation;

**.5** in ships others than passenger ones, the second stage audible alarm may simultaneously be sounded in all the spaces where officers are accommodated. In this case, the third stage audible alarm may be redundant;

**.6** in large ships the time interval between the second and third stage audible alarms may be increased up to 3 min necessary for the back-up officer and ship's master to get to the navigating bridge.

**5.22.4** The reset of the BNWAS to the initial state (acknowledgement of visual alarm receipt and deactivation of the audible alarm) shall be possible on the navigating bridge only, be carried out by one action of an operator, whereupon the countdown of the next dormant period shall start.

When the system is reset to the initial state before the termination of the dormant period, the system shall start the countdown of the next dormant period since that moment.

Reusable actions to reset the system to the initial state shall not prolong the duration of the dormant period or alter the sequence and time intervals between visual and audible alarms.

**5.22.5** The device for alarm (visual and audible) acknowledgement and system reset to the initial state shall be illuminated at night and may be integral with the BNWAS or designed as a separate block.

This device and its arrangement at the work station on the navigating bridge shall ensure its use by the watch officer only and prevent an unauthorized intervention of other people.

**5.22.6** The navigating bridge shall be provided with the means for prompt actuating the second and third stage audible alarm to urgently call the back-up officer and/or ship's master.

The function of such means shall be effected with a special button marked "Emergency Call".

**5.22.7** Under all operational conditions the BNWAS shall assure the time countdown with an accuracy of 5 per cent or 5 s, whichever is less.

**5.22.8** The BNWAS shall be provided with the following controls:

**.1** means for selection of a operational mode and duration of the dormant period protected against an unauthorized access;

**.2** means for prompt actuating the second and third stage audible alarm, if fitted;

**.3** devices for alarm acknowledgement and system reset to the initial state, which shall be readily accessible and located on bridge wings, and all the workstations of the navigating bridge.

**5.22.9** The indication of the operational mode of the BNWAS for the watch officer shall be provided.

**5.22.10** The visual alarm activated on termination of the dormant period shall be flashing and visible from any workstation on the navigating bridge. The visual alarm colour shall not impair the conditions of environmental observations at night, and its brilliance shall be regulated. In this case, an opportunity to completely switch off the visual alarm shall be excluded.

**5.22.11** The first stage audible alarm activated on the navigating bridge in 15 s after visual alarm activation shall be of a distinctive tonality or modulation and be heard by the watch officer at all the work stations on the navigating bridge. The function of the first stage audible alarm may be engineered using one or more sounding devices.

Fitting the BNWAS, provision shall be made for selection of the tonality or modulation, as well as of the audible alarm volume. The follow-up alterations

of these characteristics by the watch officer are not allowed.

**5.22.12** The second and third stage audible alarms activating sequentially if the first stage audible alarm was not acknowledged, shall be of distinctive sounding and loud enough to wake up a sleeper in spaces where the ship's master, back-up officer and officers are accommodated.

**5.22.13** All the blocks being part of the BNWAS shall be protected against unauthorized modifications in its operation introduced by the crew.

**5.22.14** Standard connectors for connecting visual and audible alarm activating devices, as well as additional devices for alarm acknowledgement and system reset to the initial state shall be used in the BNWAS.

**5.22.15** The Bridge Navigational Watch Alarm System shall be fed from the main electric power source.

The indicators signalling about the system failure and failure of power supply, as well as the elements of the Emergency Call Key (if it is available in the Bridge Navigational Watch Alarm System) shall be fed from the dedicated accumulator battery for at least 1 hour.

### 5.23 LONG-RANGE IDENTIFICATION AND TRACKING SYSTEMS (LRIT) EQUIPMENT

**5.23.1** The equipment of a Long-Range Identification and Tracking System (LRIT system) should provide automatic transmission of the following LRIT information:

- .1 the identity of the ship;
- .2 the position of the ship (latitude and longitude);
- .3 the date and time of the position provided.

**5.23.2** The LRIT system equipment shall conform to the performance standards and functional requirements of this Chapter and applicable standards 5.1 and 5.2 of Part IV "Radio Equipment".

**5.23.3** The LRIT system equipment should comply with the following minimum requirements:

.1 be capable of automatically and without human intervention on board the ship transmitting the ship's LRIT information at 6-hour intervals to an LRIT Data Centre;

.2 be capable of being configured remotely to transmit LRIT information at variable intervals;

.3 be capable of transmitting LRIT information following receipt of polling commands;

.4 interface directly to the shipborne global navigation satellite system equipment, or have internal positioning capability;

.5 be supplied with energy from the main and emergency source of electrical power.

This provision should not apply to ships using for the transmission of LRIT information any of the radio communication equipment provided for compliance with the provisions of Part IV "Radio Equipment". In such cases, the shipborne equipment should be provided with sources of energy as specified in 2.3 of Part IV of the Rules;

.6 be tested for resistance to mechanic and climatic effects as well as for electromagnetic compatibility with other electronic and electric shipborne equipment.

**5.23.4** The LRIT equipment should provide the functionality specified in Table 5.23.4.

**5.23.5** The shipborne equipment should transmit the LRIT information using a communication system which provides coverage in all areas where the ship operates.

**5.23.6** The shipborne equipment should be set to automatically transmit the ship's LRIT information at

Table 5.23.4

| Parameter                      | Comments   |
|--------------------------------|--|
| Shipborne Equipment Identifier | The identifier used by the shipborne equipment   |
| Positional data                | The GNSS position (latitude and longitude) of the ship (based on the WGS 84 datum)<br>Position: The equipment should be capable of transmitting the GNSS position (latitude and longitude) of the ship (based on WGS 84 datum) without human interaction on board the ship<br>On-demand position reports <sup>1</sup> : The equipment should be capable of responding to a request to transmit LRIT information on demand without human interaction on board the ship, irrespective of where the ship is located<br>Pre-scheduled position reports <sup>2</sup> : The equipment should be capable of being remotely configured to transmit LRIT information at intervals ranging from a minimum of 15 min to periods of 6 h to the LRIT Data Centre, irrespective of where the ship is located and without human interaction on board the ship |
| Time Stamp <sup>1</sup>        | The date and time <sup>3</sup> associated with the GNSS position<br>The equipment should be capable of transmitting the time <sup>3</sup> associated with the GNSS position with each transmission of LRIT information   |

<sup>1</sup> On-demand position reports — means transmission of LRIT information as a result of either receipt of polling command or of remote configuration of the equipment so as to transmit at interval other than the preset ones.

<sup>2</sup> Pre-scheduled position reports — means transmission of LRIT information at the preset transmit intervals.

<sup>3</sup> All times should be indicated as Universal Co-ordinated Time (UTC).



6-hour intervals to the LRIT Data Centre identified by the Administration, unless the LRIT Data User requesting the provision of LRIT information specifies a more frequent transmission interval.

**5.23.7** The LRIT equipment design should provide for the possibility of working ability periodic check without the LRIT information transmission.

**5.23.8** It should be possible to switch off the LRIT equipment or to stop the transmission of the

LRIT information (with the corresponding record in the ship's Log Book) in the following cases:

**.1** if, according to the international agreements, rules and standards, the navigational information is to be protected; or

**.2** in exceptional circumstances, and, as far as possible, for a short period of time, if the captain of the ship thinks that the LRIT equipment operation threatens the ship's safety or security level.

## 6 PERFORMANCE STANDARDS FOR THE PRESENTATION OF NAVIGATION-RELATED INFORMATION ON SHIPBORNE NAVIGATION DISPLAYS

**6.1** These performance standards specify the presentation of navigational information on the bridge of a ship, including the consistent use of navigational terms, abbreviations, colours and symbols, as well as other presentation characteristics.

These performance standards should be applied in addition to the requirements for presentation of navigational information by other navigational equipment and systems, the performance standards of which are covered by this Part of the Rules.

Any additional means of information display, not specified by this Part of the Rules, should present the navigational information in accordance with these performance standards.

**6.2** The presentation of information should be consistent with respect to screen layout and arrangement of information.

Data and control functions should be logically grouped.

Priority of information should be identified for each application, permanently displayed and presented to the user in a prominent manner by, for example, use of position, size and colour.

**6.3** The presentation of information should be consistent with respect to values, units, meaning, sources, validity, and if available, integrity.

**6.4** The presentation of information should be clearly separated into an operational display area (e. g. radar, chart) and one or more user dialogue areas (e. g. menus, data, control functions).

**6.5** The presentation of alphanumeric data, text, symbols and other graphical information (e.g. radar image) should support readability from typical user positions under all ambient light conditions likely to be experienced on the bridge of a ship, and with due consideration to the night vision of the officer of the watch.

Alphanumeric data and text should be presented using a clearly legible non-italic, sans-serif font. The font size should be appropriate for the viewing distance from user positions likely to be experienced

on the bridge of a ship. Text should be presented using simple unambiguous language that is easy to understand.

Navigation terms and abbreviations should be presented using the nomenclature defined in Table 5.7.58-1.

**6.6** When icons are used, their purpose should be intuitively recognized by appearance, placement and grouping.

**6.7** The colours used for the presentation of alphanumeric data, text, symbols and other graphical information should provide sufficient contrast against the background under all lighting conditions likely to be experienced on the bridge of a ship.

The colours and brightness should take into account the light conditions of daylight, dusk and night.

The presentation should support night viewing by showing light foreground information on a dark non-reflecting background at night.

The background colour and contrast should be chosen to allow presented information to be easily discriminated without degrading the colour coding aspects of the presentation.

**6.8** Symbols used for the presentation of operational information are defined in Table 5.7.58-3.

Symbols used for the display of charted information should comply with relevant IHO standards.

**6.9** When colour coding is used for discrimination of conspicuousness of alphanumeric text, symbols and other information, all colours in the set should clearly differ from one another.

**6.10** When colour coding is used, the red colour should be used for coding of alarm related information.

**6.11** When colour coding is used, it should be used in combination with other symbol attributes, such as size, shape, and orientation.

**6.12** Flashing of information should be reserved for unacknowledged alarms.

**6.13** The source, validity, and, where possible, the integrity of information should be indicated.

Invalid information or information with low integrity should be clearly marked, qualitatively and/or quantitatively. Invalid information or information with low integrity may be quantitatively indicated by displaying absolute or percentage values.

**6.14** When colour coding is used, information with low integrity should be qualitatively marked by using yellow, and invalid information should be qualitatively marked by using red.

**6.15** In order to show that the screen is being refreshed, means should be provided to immediately make the user aware of a presentation failure on an operational display (e.g. "picture freeze").

**6.16** The operational status of information should be indicated as shown in Table 6.16.

**6.17** A list of alarms should be provided based on the sequence of occurrence. Additional indication of priority, as set by the user, should be provided on displays showing alarms from multiple sources.

Alarms that have been acknowledged and are no longer relevant should be deleted from the list of alarms, but may be retained in an alarm history list.

**6.18** When a single display is used to present information from multiple navigation systems and equipment, the presentation of alarms and indications should be consistent for the display of the time of alarm occurrence, the cause of the alarm, the source of the alarm and the status of the alarm (e.g. acknowledged, not acknowledged).

**6.19** If displays are capable of presenting information in different mode(s), there should be a clear indication of the mode in use, for example, orientation, stabilization, motion, and chart projection.

**6.20** When a graphical representation of own ship is provided, it should be possible for the user to select either a scaled ship's outline or a simplified symbol as specified in Table 5.7.58-3.

The size of the ship's outline or the simplified symbol in the graphical presentation should be the true scale size of the ship or 6 mm, whichever is greater.

**6.21** A heading line, and where appropriate a velocity vector, should be associated with own ship symbol and should originate at the position of the consistent common reference point (CCRP).

**6.22** The presentation of charted information should comply with the relevant IHO standards.

**6.23** The presentation of proprietary charted information should comply with relevant IHO standards, as far as practical. There should be a clear indication when the presentation is not in accordance with IHO standards.

**6.24** The presentation of user-added information should comply with the relevant IHO standards, as far as practical.

**6.25** If chart data derived from different scales appear on the display, the scale boundary should be clearly indicated.

**6.26** Radar images should be displayed by using a basic colour that provides optimum contrast. Radar echoes should be clearly visible when presented on top of a chart background.

The relative strength of echoes may be differentiated by tones of the same basic colour.

The basic colour may be different for operation under different ambient light conditions.

**6.27** Target trials should be distinguishable from targets and clearly visible under all ambient light conditions.

**6.28** Target information may be provided by radar tracking and/ or by reported target information from the Automatic Identification System (AIS).

**6.29** The operation of the radar target tracking and the processing of reported AIS information, including the number of targets presented, related to screen size, should be in compliance with standards as defined in 5.7.

The presentation of radar target tracking and AIS information is defined within these performance standards.

**6.30** As far as practicable, the user interface and data format for operating, displaying and indicating radar tracking and AIS information should be consistent.

**6.31** There should be an indication when the target tracking and/ or reported target processing/display capacity is about to be exceeded.

**6.32** There should be an indication when the target tracking and/ or reported target processing/display capacity has been exceeded.

**6.33** To ensure that the clarity of the total presentation is not substantially impaired, it should be possible to filter the presentation of sleeping AIS

Table 6.16

| Status  | Visual indication               | Audible signal   |
|---|---------------------------------|--|
| Alarm, not acknowledged                                   | Red, flashing                   | Accompanied by an audible signal                       |
| Alarm, acknowledged<br>Invalid information                | Red                             | Suppression of audible signal                          |
| Important indications<br>(warnings), (e.g. low integrity) | Yellow                          | Silence unless otherwise specified by the Organization |
| Normal state  | None required, optionally green | Silence  |

targets (e.g. by target range, CPA/TCPA or AIS target class A/B, etc.).

Sleeping AIS targets should be automatically activated when meeting user defined parameters (e.g. target range, CPA/TCPA or AIS target class A/B).

**6.34** If a filter is applied, there should be a clear and permanent indication.

The filter criteria in use should be readily available.

**6.35** It should not be possible to remove individual AIS targets from the display.

**6.36** If zones for the automatic activation of AIS targets are provided, they should be the same as for automatic radar target acquisition, if available.

Any user defined zones (e.g. acquisition/activation zones) in use should be presented in graphical form.

**6.37** Targets should be presented with their relevant symbols according to Table 5.7.58-3.

**6.38** AIS information should be graphically presented either as sleeping or activated targets.

**6.39** The course and speed of a tracked radar target or reported AIS target should be indicated by a vector that clearly shows the predicted motion. The vector time (length) should be consistent for presentation of any target regardless of its source.

**6.40** The presentation of vector symbols should be consistent irrespective of the source of information.

The presentation mode should be clearly and permanently indicated, including for example: True/Relative vector, vector time and vector stabilisation.

**6.41** The orientation of the AIS target symbol should indicate its heading.

If the heading information is not received, the orientation of the AIS symbol should be aligned to the COG.

When available, the turn or rate of turn (ROT) indicator and/ or the path prediction should indicate the manoeuvre of an activated AIS target.

**6.42** A consistent common reference point should be used for the alignment of tracked target symbols and AIS target symbols with other information on the same display.

**6.43** On large scale/low range displays, a means to present a true scale outline of an activated AIS target should be provided.

**6.44** It should be possible to display the past positions of activated targets.

**6.45** A target selected for the display of its alphanumeric information should be identified by the relevant symbol.

If more than one target is selected for data display, the symbols and the corresponding data should be clearly identified.

**6.46** There should be a clear indication to show that the target data is derived from radar or AIS or from a combination of these.

**6.47** For each selected tracked radar target the following data should be presented in alphanumeric form: source(s) of data, measured range of target, measured bearing of target, predicted target range at the closest point of approach (CPA), predicted time to CPA (TCPA), true course of target, true speed of target. Additional target information should be provided on request.

**6.48** For each selected AIS target the following data should be presented in alphanumeric form: source of data, ship's identification, position and its quality, calculated range of target, calculated bearing of target, CPA, TCPA, COG, SOG, navigational status. Additional target information should be provided on request.

**6.49** If the received AIS information is incomplete, the absent information should be clearly indicated in the target data field as missing.

**6.50** The data should be displayed and continually updated, until another target is selected for data display or until the window is closed.

**6.51** Means should be provided to present own ship AIS data on request.

**6.52** The alphanumeric displayed data should not obscure graphically presented operational information.

**6.53** A clear indication of the status of the alarms and of the alarm criteria should be given.

**6.54** A CPA/TCPA alarm of a tracked radar or activated AIS target should be clearly indicated and the target should be clearly indicated and the target should be clearly marked by a dangerous target symbol.

**6.55** If a user defined acquisition/ activation zone facility is provided, a target entering the zone should be clearly identified with the relevant symbol and for tracked radar targets an alarm should be given. The zone should be identified with the relevant symbolology, and should be applicable to tracked radar and AIS targets.

**6.56** The last position of a lost target should be clearly marked by a lost target symbol on the display, and the lost target alarm should be given.

The lost target symbol should disappear if the signal is received again, or after the alarm has been acknowledged.

There should be a clear indication whether the lost target alarm function for AIS targets is enabled or disabled.

**6.57** An automatic target association function serves to avoid the presentation of two target symbols for the same physical target.

If target data from AIS and radar tracking are both available and if the AIS and radar information are considered as one target, then as a default condition, the activated AIS target symbol and the

alphanumeric AIS target data should be automatically selected and displayed.

The user should have the option to change the default condition to the display of tracked radar targets and should be permitted to select either radar tracking or AIS alphanumeric data.

**6.58** If the AIS and radar information are considered as two distinct targets, one activated AIS target and one tracked radar target should be displayed. No alarm should be raised.

**6.59** The AIS presentation status should be indicated according to Table 6.59.

**6.60** A trial manoeuvre simulation should be clearly identified by the relevant symbol positioned astern of own ship within the operational display area of the screen.

**6.61** If the display equipment is capable of supporting the presentation of multiple functions then there should be a clear indication of the primary function supported by the presentation (e.g. Radar, ECDIS).

It should be possible to select the Radar presentation or the ECDIS presentation by a simple operator action.

**6.62** If a radar image and an electronic chart are displayed together, the chart and the radar image should use a consistent common reference point and match in scale, projection and orientation. Any offset should be indicated.

**6.63** Range scales of 0,25; 0,5; 0,75; 1,5; 3; 6; 12 and 24 NM should be provided. Additional range scales are permitted. These range scales do not apply when presenting raster chart data.

The range scale should be permanently indicated.

**6.64** When range rings are displayed, the range ring scale should be indicated.

**6.65** No part of the operational display area should be permanently used for presentation of information that is not part of the navigation

presentation (e.g. pop up displays, drop down menus and information windows).

Temporary, limited and relevant alphanumeric data may be displayed adjacent to a selected symbol, graphic or target within the operational display area.

**6.66** RADAR display.

**6.66.1** Radar video, tracked radar targets and AIS targets should not be substantially degraded, masked or obscured by other presented information.

**6.66.2** It should be possible to temporarily suppress all graphical information from the display, retaining only radar video and trails.

**6.66.3** The brightness of radar echoes and associated graphic symbols for tracked radar targets should be variable. It should be possible to control the brightness of all displayed information. There should be independent means to adjust the brightness of groups of displayed graphics and alphanumeric data. The brilliance of the heading line should not be variable to extinction.

**6.66.4** Vector chart information may be displayed on a radar presentation. This should be accomplished using layers selected from the chart database. As a minimum, the elements of the ECDIS Standard Display should be available for individual selection by category or layer, but not as individual objects. As far as practical, chart information should be presented in accordance with the ECDIS performance standards and with these presentation standards.

**6.66.5** If chart information is displayed within the operational display area, the display of radar information should have priority. The chart information should be clearly perceptible as such. The chart information should not substantially degrade, mask or obscure the radar video, tracked radar targets and AIS targets.

**6.66.6** When chart information is displayed, there should be permanent indication of its status. Source

Table 6.59

| Function   | Cases to be presented   |  | Presentation               |
|--|---|--|----------------------------|
| AIS ON/OFF   | AIS processing switched ON/<br>graphical presentation switched<br>OFF | AIS processing switched ON/<br>graphical presentation<br>switched ON | Alphanumeric or graphical  |
| Filtering of sleeping AIS targets<br>(6.33 — 6.35) | Filter status   | Filter status  | Alphanumeric or graphical  |
| Activation of targets (6.33, 6.36)                 |   | Activation criteria  | Graphical                  |
| CPA/TCPA (6.53 — 6.56)                             | Function ON/OFF<br>CPA/ TCPA Criteria Sleeping<br>targets included    | Function ON/OFF<br>CPA/TCPA Criteria Sleeping<br>targets included    | Alphanumeric and graphical |
| Lost target alarm (6.56)                           | Function ON/OFF<br>Lost target filter criteria                        | Function ON/OFF<br>Lost target filter criteria                       | Alphanumeric and graphical |
| Target association (6.57 — 6.58)                   | Function ON/OFF<br>Association criteria<br>Default target priority    | Function ON/OFF<br>Association criteria<br>Default target priority   | Alphanumeric               |

and update information should also be made available.

**6.66.7** Map graphics may be displayed, but not substantially degrade, mask or obscure the radar video, tracked radar targets and AIS targets.

**6.67 ECDIS display**

**6.67.1** The ENC and all updates to it should be displayed without any degradation of their information content.

**6.67.2** Chart information should not be substantially degraded, masked or obscured by other presented information.

**6.67.3** It should be possible to temporarily suppress all supplemental information from the display, retaining only chart related information contained in the Display Base.

**6.67.4** It should be possible to add or remove information from the ECDIS display. It should not be possible to remove information contained in the Display Base from the ECDIS display.

**6.67.5** It should be possible to select a safety contour from the depth contours provided by the ENC. The safety contour should be emphasized over other contours on the display.

**6.67.6** It should be possible to select a safety depth. Soundings equal to or less than the safety depth should be emphasized whenever spot soundings are selected for display.

**6.67.7** An indication should be provided if the information is displayed at a larger scale than that contained in the ENC, or if own ship's position is covered by an ENC at a larger scale than that provided by the display.

**6.67.8** Overscaled areas shown on the ECDIS display should be identified.

**6.67.9** Radar and target information may be displayed on ECDIS but should not substantially degrade, mask or obscure the chart information. As far as practical, radar and target information should be presented in accordance with the radar performance standard and with these presentation standards.

**6.67.10** Radar and target information should be clearly distinguishable from the chart information. It should be possible to remove this information by a simple operator action.

**6.67.11** Information from additional sources may be displayed on ECDIS but should not substantially degrade, mask or obscure the chart information.

**6.67.12** Additional information should be clearly distinguishable from the chart information. It should be possible to remove this information by a simple operator action.

**6.68** The user may configure a presentation for a specific task at hand. The presentation may include radar and/ or chart information, in combination with

other navigation or ship related data. When not fully compliant with the Radar or ECDIS performance standards, such a presentation should be identified as an auxiliary presentation.

**6.69** As far as practical, the presentation of any radar and/or ECDIS related functions should be compliant with the requirements of the relevant performance standards and of these presentation standards, with the exception of size requirements for the operational area. Chartlets or windows or radar information may be presented along with other information associated with the task at hand.

**6.70** It should be possible to adjust the contrast and brightness of the display provided, as applicable to the display technology. It should not be possible to dim the display. The range of control should permit the display to be legible under all ambient light conditions.

**6.71** It should be possible for the navigator to reset the values of contrast and/ or brightness to a preset or default condition.

**6.72** Where magnetic fields degrade the presentation of navigation information, a means to neutralise the effect of magnetic fields should be provided.

**6.73** Display equipment should be of sufficient size to support the requirements of the relevant performance standards specified in this Part of the Rules.

**6.74** The operational display area of the chart presentation for route monitoring should be at least 270x270 mm.

**6.75** The operational display area of the radar presentation should be at least a circle of diameter of:

180 mm — for ships smaller than 500 gross tonnage;

250 mm — for ships larger than 500 gross tonnage and High-Speed Craft (HSC) less than 10000 gross tonnage;

320 mm — for ships larger than 10000 gross tonnage.

**6.76** Multicoloured display equipment should be used except where monochrome displays are permitted within individual performance standards specified in this Part of the Rules.

**6.77** Multicoloured operational displays including multifunction displays (e. g. conning displays) should provide a minimum of 64 colours except where permitted or not required, or when used for a single specific purpose (e. g. speed log, echo sounder).

**6.78** Operational display equipment including multifunction displays (e. g. conning displays) should provide a minimum screen resolution of 1280x1024, or equivalent for a different aspect ratio, except where permitted or not required, or when used for a single specific purpose (e. g. speed log, echo sounder).

**6.79** The display should support the reading of information under all ambient conditions, simulta-

neously, by at least two users, from standing and sitting operator positions likely to be found on the bridge of a ship.

**6.80** Technical specifications, operational and maintenance instructions of the means of presenta-

tion of navigational information should be constantly available on each ship in English (Russian) language. This information should contain the list of all relevant terms, abbreviations, symbols and definitions.

## APPENDIX

## RULE STANDARD FOR BRIDGE DESIGN, EQUIPMENT ARRANGEMENT AND PROCEDURES (BDEAP)

The present Appendix is applied to ships contracted for construction on or after 1 January, 2006.

**Contents****Foreword****1 General**

- 1.1 Scope and approach
- 1.2 Structure and application
- 1.3 Normative references
- 1.4 Informative references
- 1.5 Definitions
- 1.6 Volume of documentation to be submitted by the shipbuilder for approval
- 1.7 Volume of documentation to be submitted by the shipbuilder for information
- 1.8 Volume of documentation to be submitted by the shipowners for approval
- 1.9 Volume of documentation to be submitted by the shipowners for information
- 1.10 On board tests
- 2 Bridge design**
- 2.1 Functions, tasks and means
- 2.2 Types and range of workstations
- 2.3 Working environment
- 2.4 Bridge passageways
- 2.5 Workstations arrangements and required fields of vision

2.6 Fields of vision and bridge window arrangement

2.7 Workstations layout, consoles and chair arrangement

**3 Design and arrangement of navigational systems and equipment**

3.1 Design and quality of navigational systems and equipment

3.2 Bridge alarm management

3.3 Arrangement of navigational systems and equipment

**4 Bridge procedures**

4.1 Bridge team management

4.2 Other bridge procedures

**Annex 1.** Analysis and details of bridge design principles and equipment arrangement

**Annex 2.** Examples of arrangement of bridge main equipment

Table of tasks and related means for safe operations

Separate workstations

Standby workstations.

## **RULE STANDARD FOR BRIDGE DESIGN, EQUIPMENT ARRANGEMENT AND PROCEDURES (BDEAP)**

### **INTRODUCTION**

The present Rule Standard for Bridge Design, Equipment Arrangement and Procedures (BDEAP) set forth a set of requirements for compliance with the principles and aims of SOLAS-74 and other international documents relating to the bridge design.

The requirements include guidance notes that are recommendations on how the requirements may be met by acceptable technical solutions, which shall be considered examples only and do not in any way exclude alternative solutions that may fulfill the purpose of the requirements.

The requirements, which affect bridge design, design and arrangement of navigational equipment and systems on the bridge and bridge procedures shall be taken with the aim of:

**.1** facilitating the tasks to be performed by the bridge team and the pilot in making full appraisal of the situation and in navigating the ship safely under all operational conditions.

**.2** promoting effective and safe bridge resource management;

**.3** enabling the bridge team and the pilot to have convenient and continuous access to essential information, which is presented in a clear and unambiguous manner, using standardized symbols and coding systems for controls and displays;

**.4** indicating the operational status of automated functions and integrated components, systems and/or sub-systems;

**.5** allowing for expeditious, continuous and effective information processing and decision-making by the bridge team and the pilot;

**.6** preventing or minimizing excessive or unnecessary work and any condition or distraction on the bridge, which may cause fatigue or interfere with the vigilance of the bridge team and the pilot;

**.7** minimizing the risk of human error and detecting such error, if it occurs, through monitoring and alarm systems, in time for the bridge team and the pilot to take appropriate action.

Overview of design principles of the present requirements is given in Fig. 1.



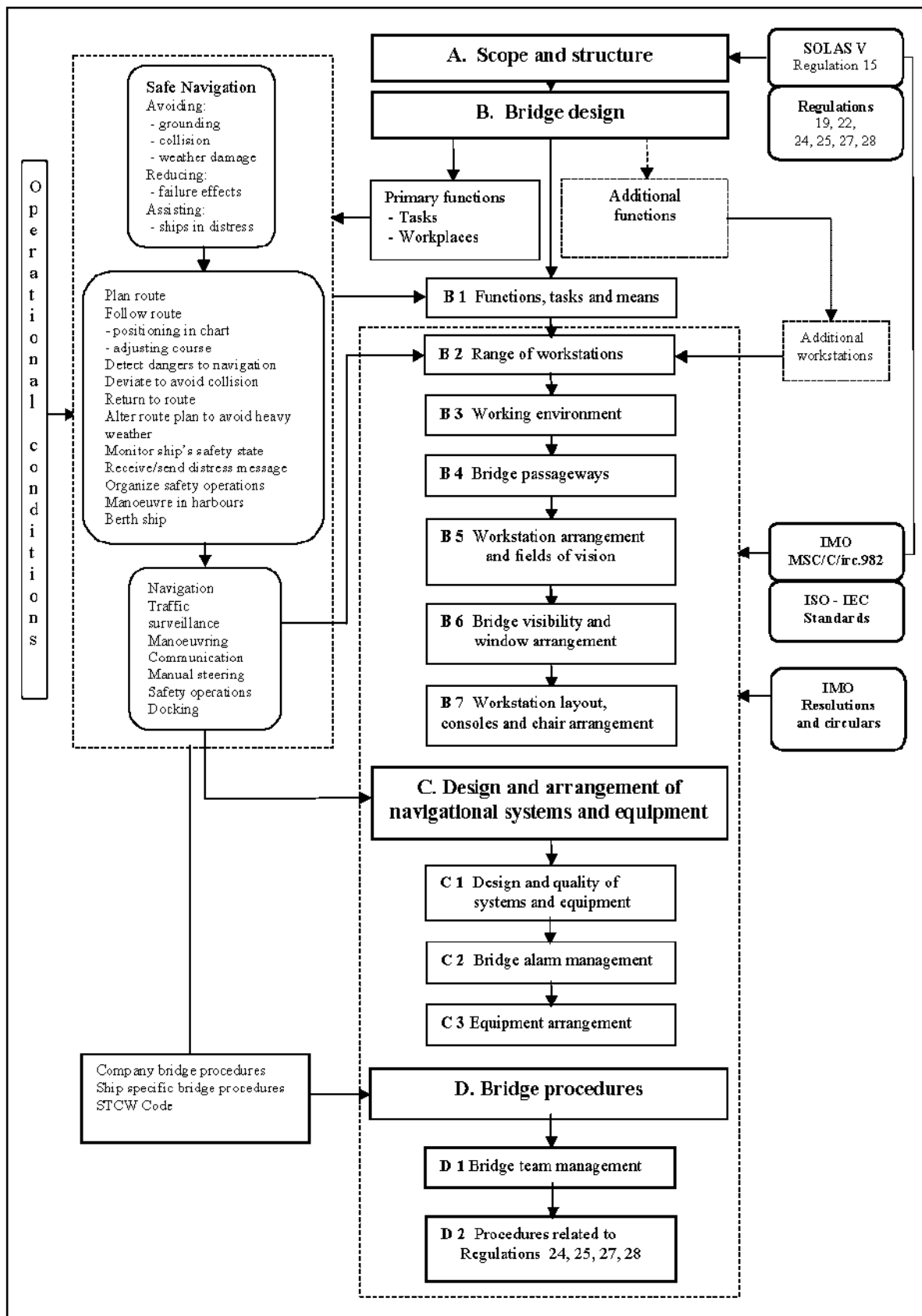

Fig. 1  
Design principles of the requirements

## 1 GENERAL

### 1.1 APPLICATION

**1.1.1** The present Rule Standard contains a set of requirements for compliance with the principles and aims of SOLAS regulation V/15, when applying the requirements of the following regulations of SOLAS Chapter V:

- 19 "Carriage requirements for shipborne navigational systems and equipment";
- 22 "Navigation bridge visibility";
- 24 "Use of heading and/or track control systems";
- 26 "Steering gear: testing and drills";
- 27 "Nautical charts and nautical publications";
- 28 "Records of navigational activities" taking regulations 18 and 20 into consideration.

The requirements of these regulations are harmonized with the guidelines of MSC/Circ.982 and the relevant ISO and IEC standards.

Note. Refer to Annex 1.

### 1.2 STRUCTURE AND APPLICATION

**1.2.1** The present Rule Standard is structured to reflect the areas and aims addressed by regulation 15.

#### 1.2.1.1 Requirements.

The requirements cover the provisions of Chapter V of SOLAS-74 and applicable parts of MSC/Circ.982, enabling the present Rule Standard to be used as a stand-alone document for the purpose of development and subsequent approval of the appropriate technical documentation relating to the following areas of:

- bridge design;
- design and arrangement of navigational systems and equipment;
- bridge procedures.

#### 1.2.1.2 Guidance note.

Guidance notes as how the requirements may be met by the acceptable technical solutions or other remedies are given when applicable. A guidance note given does not in any way exclude the alternative solutions that may fulfill the purpose and intention of the said requirements, providing other requirements and the overall bridge functionality are not adversely affected.

#### 1.2.1.3 Annexes.

There are two annexes attached to the present Rule Standard. Annex 1 contains three individual parts for clarification and consideration of:

- application of SOLAS regulation V/15;
- documents referred to by regulation 15 and the SOLAS regulations to be applied cross-referencing the individual aims of regulation 15 and the regulations affected;

- the effect of MSC/Circ.982 on the requirements of SOLAS regulation V/22 "Navigation bridge visibility" by comparison and harmonization of content.

Annex 2 contains examples of arrangement of main equipment on the bridge.

**1.2.2** The content of separate parts of the present Rule Standard is structured with the aim of enabling it to serve as a rational checklist through the different levels of development and approval of the technical documentation.

**1.2.3** Approval of the technical documentation developed on the basis of the present Rule Standard proves compliance with the requirements of SOLAS regulation V/15 when applying SOLAS regulations V/19, V/22, V/24, V/25, V/27 and V/28 at the time of delivery of the newbuilding.

Verification of compliance with regulations V/19 and V/22 addressing technical requirements for bridge equipment and design, includes verification of the ability of the bridge design, layout and equipment arrangement to promote effective and safe bridge resource management.

Procedures established for bridge resource management and for the purposes specified in SOLAS regulations V/24, V/25, V/27 and V/28 shall be verified in compliance with the requirements of the ISM Code prior to delivery of the ship and becoming part of the ship's safety management system and included in the ISM certification.

### 1.3 NORMATIVE REFERENCES

**1.3.1** Applicable parts of MSC/Circ.982 — Guidelines on ergonomic criteria for bridge equipment and layout;

MSC/Circ.603 — Guidelines on display sizes and techniques for navigational purposes;

IMO resolution A.694(17) — General requirements for shipborne radio equipment forming part of the global maritime distress and safety system (GMDSS) and for electronic navigational aids;

IMO resolution A.830(19) — Code on alarms and indicators, 1995.

#### 1.4 INFORMATIVE REFERENCES

**1.4.1** ISO and IEC standards referred to in MSC/Circ.982 for relevant additional information:

ISO 8468, Ship's bridge layout and associated equipment - Requirements and guidelines;

ISO 14612, Additional requirements and guidelines for centralized and integrated functions;

IEC 60945, Maritime navigation and radio communication equipment and systems — General requirements — Methods of testing and required test results;

IEC 61174, Electronic Chart Display and Information System (ECDIS) — Operational and performance requirements, methods of testing and required test results.

**1.4.2** International Management Code for the Safe Operation of Ships and for Pollution Prevention (ISM Code).

**1.4.3** Company and Ship Specific Bridge Procedures Manual.

**1.4.4** International Convention on Standards of Training, Certification and Watchkeeping for Seafarers, 1978, as amended (STCW Convention-78/95).

#### 1.5 DEFINITIONS

For the purpose of this document:

**1.5.1** Alarm means an alarm or alarm system, which announces by audible and visual means a condition requiring attention.

**1.5.1.1** Accept means manual silencing of an audible alarm.

**1.5.1.2** Acknowledge means action for silencing of audible alarm and bringing visual alarm to steady state.

**1.5.1.3** Cancel means manual stopping of a visual alarm after the cause has been eliminated.

**1.5.2** Bridge means the area, from which the navigation and control of the ship is exercised, including the wheelhouse and bridge wings.

**1.5.2.1** Bridge wings mean those parts of the bridge on both sides of the ship's wheelhouse, which, in general, extend to the ship's side.

**1.5.2.2** Navigating bridge means area of a wheelhouse or enclosed bridge allocated navigating functions and control of the ship, and which includes any additional bridge workstation to be used by the officer of the watch.

**1.5.2.3** Totally enclosed bridge means a bridge without open bridge wings, meaning that bridge wings form an integral part of an enclosed wheelhouse.

**1.5.2.4** Wheelhouse means enclosed area of the bridge.

**1.5.3** Bridge functions mean functions comprising tasks related to operation of the ship and carried out on the bridge.

**1.5.3.1** Primary bridge functions mean functions related to determination, execution and maintenance of safe course, speed and position of the ship in relation to the waters, traffic and weather conditions.

Such functions are:

route planning functions;

navigation functions;

collision avoidance functions;

maneuvering functions;

docking functions;

monitoring of safety systems;

external and internal communication related to safety in bridge operations including distress situations;

pilotage functions.

**1.5.3.2** Additional bridge functions mean functions related to ship operations, which shall be carried out on the bridge in addition to primary functions, but not necessarily by the watch officer. Examples of such functions are:

extended communication functions;

monitoring and control of ballasting and cargo operations;

monitoring and control of machinery;

monitoring and control of domestic systems.

**1.5.4** Close to means within functional reach (inside the wheelhouse).

**1.5.5** Collision avoidance functions mean detection and plotting of other ships and moving objects; determination and execution of course and speed deviations to avoid collision.

**1.5.6** Commanding view means view without obstructions, which could interfere with the navigator's ability to perform his main tasks, covering at least the field of vision required for safe performance of collision avoidance functions (225°).

**1.5.7** Conning station or position means place in the wheelhouse with a commanding view, providing the necessary information for conning and which is used by navigators, including pilots, when monitoring and directing the ship's movements.

**1.5.8** Docking means maneuvering the ship alongside a berth while controlling mooring operations.

**1.5.9** Maneuvering means operation of steering systems and propulsion machinery as required to move the ship into predetermined directions, positions or tracks.

**1.5.10** Monitoring means act of constantly checking information from instrument displays and environment in order to detect any irregularities.

**1.5.11** Navigation means planning of the ship's route and determination of position and course of the ship, execution of course alterations and speed changes.

**1.5.12** Operating conditions:

**1.5.12.1** Normal operating conditions when all shipboard systems and equipment related to primary bridge functions operate within design limits, and weather conditions or traffic do not cause excessive operator workloads.

**1.5.12.2** Irregular operating conditions when external conditions cause excessive operator workloads.

**1.5.12.3** Abnormal operating conditions when malfunction of technical system requires operation of backup systems on the bridge, or when it occurs during an irregular operating condition, or when the officer of the watch becomes unfit to perform his duties and has not yet been replaced by another qualified officer.

**1.5.12.4** Emergency situations when incidents seriously affect internal operating conditions of the ship and the ability to maintain safe course and speed (fire, ship system technical failure, structural damage).

**1.5.13** Waters:

**1.5.13.1** Ocean areas mean waters that encompass navigation beyond the outer limits of coastal waters. Ocean areas do not restrict the freedom of course setting in any direction for a distance equivalent to 30 minutes of sailing with the relevant ship speed.

**1.5.13.2** Coastal waters mean waters that encompass navigation along a coast at a distance less than the equivalence of 30 minutes of sailing with the relevant ship speed. The other side of the course line allows freedom of course setting in any direction for a distance equivalent to at least 30 minutes of sailing with the relevant speed.

**1.5.13.3** Narrow waters mean waters that do not allow the freedom of course setting to any side of the course line for a distance equivalent to 30 minutes of sailing with the relevant ship speed.

**1.5.14** Route planning means pre-determination of course lines, radius turns and speed in relation to the waters to be navigated.

**1.5.15** Workstation means a workplace, at which one or several tasks constituting a particular activity are carried out, and which provides the information and equipment required for safe performance of the tasks.

**1.5.16** Workstation for monitoring means a workstation facilitating equipment and a commanding view for observation of the ship's heading and speed, the waters and traffic, incorporating means as required for positioning of the ship,

and if located close to the front windows may serve as conning station for the master and a pilot carrying out control and advisory functions.

**1.5.17** Workstation for navigating and maneuvering means a workstation with commanding view used by navigators when carrying out navigation, route monitoring, traffic surveillance and maneuvering functions, and which enables monitoring of the safety state of the ship.

**1.5.18** Workstation for radio communication means a workplace for operation and control of equipment for Global Maritime Distress and Safety System (GMDSS), and shipboard communication for ship operations.

**1.5.19** Workstation for safety operations means a workplace-dedicated organization and control of internal emergency and distress operations, and which provides easy access to information related to the safety state of the ship.

## 1.6 DOCUMENTATION TO BE SUBMITTED BY THE SHIPBUILDER FOR APPROVAL

**1.6.1** Fields of vision drawings showing:

**.1** the horizontal field of vision from the various workstations, including the arc of individual blind sectors and the sum of blind sectors forward of the beam;

**.2** the vertical field of vision over the bow from the conning station and the workstation for navigation and maneuvering, including the line of sight under the upper edge of the window from standing working position at the workstation;

**.3** window arrangement, including inclination, dimensions, framing and height of lower and upper edge above bridge deck surface as well as the height of the deckhead.

**1.6.2** Bridge layout drawings showing:

**.1** the bridge layout, including the configuration and location of all bridge workstations, including workstations for additional bridge functions (refer also to 7.1);

**.2** configuration and dimensions of workstation consoles including console foundations.

**1.6.3** Equipment location drawings showing:

**.1** location of instruments and equipment in all workstation consoles;

**.2** location of equipment located elsewhere on the bridge (refer also to 7.1).

**1.6.4** List of equipment showing:

all relevant bridge equipment with specification of type, model, manufacturer, supplier and type approval reference with extension date or copy of valid certificates, when applicable.

### 1.7 DOCUMENTATION TO BE SUBMITTED BY THE SHIPBUILDER FOR INFORMATION

**1.7.1** Manuals or instructions for equipment installed for the use of bridge personnel shall be submitted for information upon request.

### 1.8 DOCUMENTATION TO BE SUBMITTED BY THE SHIPOWNERS FOR APPROVAL

**1.8.1** Ship specific bridge procedures covering: the use of the heading and/or track control system, operation of steering gear, updating of nautical charts and recording of navigational activities proving compliance with SOLAS regulations V/24, V/25, V/27 and V/28.

**1.8.2** Paragraph 1.8.1 shall be included in the ship's management plan for the ISM certification.

### 1.9 DOCUMENTATION TO BE SUBMITTED BY THE SHIPOWNERS FOR INFORMATION

**1.9.1** If navigational functions and bridge team management shall be carried out or organized other than as indicated in this Rule Standard (refer to 2.1 and 4.1), documentation describing the differences and operational procedures shall be submitted in

conjunction with relevant drawings of bridge layout and equipment location submitted by the shipbuilder for approval (refer to 1.5.2, 1.5.3).

**1.9.2** Description of functions to be performed at workstations, which are additional to workstations for primary bridge functions, shall be submitted.

**1.9.3** Ship specific bridge procedures covering: distribution of bridge functions and tasks (refer to 2.1);

manning and training requirements on the bridge at identified operating conditions taking into account the requirements in 2.1.

*Note.* Paragraph 1.9.3 shall be included in the ship's safety management system (SMS) under the ISM Code.

### 1.10 ON BOARD TESTS

**1.10.1** A program for the on board testing of the bridge equipment and systems required to be carried, as well as additional navigation equipment installed, shall be submitted for approval at the earliest possible stage before sea trials.

**1.10.2** Equipment and systems shall be subject to the tests required to ascertain that all controls, indicators, displays, etc., operate in accordance with their specifications and meet IMO requirements.

**1.10.3** Failure conditions shall be simulated on equipment and systems.

## 2 BRIDGE DESIGN

The bridge shall be designed and arranged with the aim of:

- facilitating the tasks to be performed by the bridge team and the pilot in making full appraisal of the situation and in navigating the ship safely under all operational conditions;

- promoting effective and safe bridge resource management;

- allowing for expeditious, continuous and effective information processing and decision-making by the bridge team and the pilot;

- preventing or minimizing excessive or unnecessary work and any condition or distraction on the bridge, which may cause fatigue or interfere with the vigilance of the bridge team and the pilot.

The design of bridge is governed by:

- the functions and related tasks to be carried out on the bridge, systems used and methods of task performance;

- the range, layout and location of workstations required for performance of bridge functions;

- the fields of vision required for visual observations from each of the workstations;

- composition of the bridge team and the procedures required for safe operations under all identified conditions;

- the type and range of equipment to be provided for performance of the tasks at the individual workstations and elsewhere on the bridge.

### 2.1 FUNCTIONS, TASKS AND MEANS

The table given below shows the main bridge functions and tasks to be carried out on the bridge. The types of approved equipment that are related to the performance of different tasks are indicated. The list may serve as basis for outfitting of workstations. The type of equipment installed on the individual bridge, the system configurations and automation level may affect the method of navigation, operational procedures and qualification levels.

Table 2.1.1

| Tasks and means   |   |   |  |
|---|---|---|--|
| Tasks to be performed   | Equipment to be operated  | Information to be viewed  | Remarks  |
| <i>Navigation</i><br>– <i>Grounding avoidance</i>   |   |   |  |
| <b>Planning</b>   |   |   |  |
| Plan route prior to departure   | Paper chart/table   |   |  |
| Alter route while under way   | Nautical publications<br>GNSS<br>ECDIS*<br>ECDIS backup**                             |   | *Optional installation<br>**If replacing paper   |
| <b>In Transit</b>   |   |   |  |
| Monitor route-keeping:<br>- Determine position by bearings<br>- Read position on display<br>- Plot position | Pelorus/gyro repeater*<br>Radar<br>GNSS<br>Paper chart/table                          |   | *Analogue<br>Bearings 360° around the horizon,<br>(one on each bridge wing)                    |
| - Determine and plot position automatic   | ECDIS   |   | Optional installation  |
| Maintain route/alter course by<br>- manual steering<br>- using autopilot<br>- automatic route-keeping       | Manual steering control<br>Heading control system<br>Track control system*<br>(ECDIS) |   | *Alternative to heading control<br>Interfaced to ECDIS, gyro, speed,<br>radar when part of INS |
| Give sound signals  | Whistle control   |   | Fog – traffic  |
| Receive sound signals   | Sound reception system  | Loudspeakers  | Totally enclosed bridge  |
| Monitor/Take action:<br>- operational warnings<br>- system failure alarms                                   | Alarm panel   |   |  |
| - ship's safety state   | Alarm systems   |   |  |
| Monitor heading, turn, rudder angle, speed, propulsion  |   | Gyro repeater<br>Indicators:<br>- rudder angle<br>- rate-of-turn<br>- RPM, Pitch<br>- speed log |  |
| Adjust lighting   | Dimmer buttons  |   |  |
| Monitor shallow water areas   | Echo Sounder system   | Water depth   | (Anchoring)  |
| Monitor performance automatic route-keeping system  |   | Conning info display  | Organizing indicator info providing situation awareness when in automatic route-keeping mode   |
| Effect internal communication   | Intercom (auto telephone)   |   |  |
| Effect external communication   | VHF   |   | Related to navigation  |
| Receive/send distress message   | GMDSS equipment or remote control   |   |  |

Table 2.1.1 — continued

| Tasks and means   |  |   |   |
|---|--|---|---|
| Tasks to be performed   | Equipment to be operated   | Information to be viewed  | Remarks   |
| <i>Traffic surveillance</i><br>- <i>Collision avoidance</i>   |  |   |   |
| Detect floating targets<br>Analyse traffic situations<br>Observe visually<br><br>Decide on collision avoidance measures | Radar with ETP* (may incl. AIS)<br>Binoculars<br>Window wiper -cleaning - heating control<br>AIS (automatic identification system) | Targets' relative position, course, speed. Expected passing distance<br>Time<br>Target true position, course, speed | *Electronic target plotting ("historical" data)<br><br>Regarded additional info (means)                         |
| Manoeuvring   |  |   | (For route-keeping)   |
| Change steering mode  | Steering mode switch   |   |   |
| Alter heading   | Heading control  | Heading (Gyro)  |   |
| Observe rudder angle  |  | Rudder angle  |   |
| Override steering   | Override control   |   |   |
| Manual steering control   |  |   |   |
| Change speed  | Propulsion control   | RPM/Pitch   |   |
| Give sound signals  | Whistle control  |   |   |
| Receive sound signals   | Sound reception system   | Loudspeaker   | Totally enclosed bridges  |
| Navigate back to route  | Paper chart/table<br>GNSS  |   |   |
| Maintain track of traffic   | Radar with route and navigable waters<br>ECDIS*  |   | *May replace paper  |
| Harbour manoeuvring   | Thruster   |   | Optional  |
| Anchoring   |  |   |   |
| Manoeuvre<br><br>Positioning<br>(Identify anchor position)  | Manual steering control<br>Propulsion control (Thruster control.)<br>Radar<br>Chart<br>GNSS  | Heading<br>Rudder angle<br>RPM/Pitch<br>Water depth   | Performed at front workstations or in combination with docking station<br>Information to be provided for pilots |
| Observe ship's safety state   |  |   |   |
| Monitor alarm conditions:<br>- Navigation alarms<br>Equip. & system failures<br>Operational warnings                    | Main alarm panel<br>W/indicators and acceptance button   | Alarm list  | See 3.2   |
| - Machinery alarms  | Alarm panel  |   |   |
| - Cargo alarms  | Alarm panel  |   |   |
| - Fire alarm  | Fire alarm panel   |   |   |
|   |  |   |   |
| <i>Manual steering</i>  |  |   | (Rating)  |
| Maintain, adjust, alter heading according to order  | Steering control<br>Intercom (Command)   | Gyro repeater<br>Magnetic comp.<br>Rudder angle<br>Rate-of-turn   |   |

| Tasks and means   |                          |                          |                |
|---|--------------------------|--------------------------|----------------|
| Tasks to be performed   | Equipment to be operated | Information to be viewed | Remarks        |
| <i>Conning functions</i>  |                          |                          |                |
| Determine & direct course and speed in relation to waters and traffic |                          |                          |                |
| Monitor:  |                          |                          |                |
| - heading   |                          | Gyro repeater            | May be digital |
| - rudder angle  |                          | Rudder angle             |                |
| - rate-of-turn  |                          | RoT indicator            |                |
| - propulsion  |                          | RPM/Pitch                |                |

Table 2.1.1 — continued

| Tasks and means       |                          |                          |           |
|-----------------------|--------------------------|--------------------------|-----------|
| Tasks to be performed | Equipment to be operated | Information to be viewed | Remarks   |
| - speed               |                          | Speed log                |           |
| - water depth         |                          | Echo sounder display     | Anchoring |
| Give sound signals    | Whistle control button   |                          |           |
| Effect communication  | VHF                      |                          | Available |

| Tasks and means  |                                  |                          |                                     |
|--|----------------------------------|--------------------------|-------------------------------------|
| Tasks to be performed  | Equipment to be operated         | Information to be viewed | Remarks                             |
| <i>Safety operations</i>   |                                  |                          |                                     |
| Take action on alarm condition:<br>- analyse situation<br>- consult plans and drawings   | Manuals – Drawings – (PC)        |                          | May be computer based info          |
| - observe ship's external operational situation  |                                  |                          | Cooperation with navigating officer |
| - organize and execute measures by communication<br>- check status of ventilation system | Intercom (UHF)<br>Emergency stop |                          |                                     |
| Monitor development of alarm conditions  | Alarm panel/screen               |                          |                                     |
| - Cargo alarms   | Alarm panel                      |                          |                                     |
| - Fire detection & alarms  | Fire detection and alarm panel   |                          |                                     |
| - Gas & smoke detection  |                                  |                          |                                     |
| <i>External communication</i>  |                                  |                          |                                     |
| Distress - weather - safety  | GMDSS equipment                  |                          | As required (Area)                  |
| Determine weather conditions<br>Consider navigation warnings                             | Navtex receiver                  |                          |                                     |
| Public correspondence  | Additional equipment             |                          | Specified by owners                 |

|  |  |                         |                                   |
|--|--|-------------------------|-----------------------------------|
| <i>Docking operations (bridge wings)</i> |  |                         |                                   |
| Directing steering                       | Intercom (command)                                 | Heading<br>Rudder angle |                                   |
| Directing speed                          | Intercom (command)                                 | RPM/Pitch               |                                   |
| Giving sound signals                     | Whistle control button                             |                         |                                   |
| Receiving sound signals                  | Sound reception system                             | Loudspeaker             | Totally enclosed bridge           |
| Perform manoeuvring                      | Steering<br>Propulsion control<br>Thruster control |                         | Additional installation by owners |
| <i>Additional functions</i>              |  |                         | See 2.2                           |



It is regarded as the responsibility of the ship-owners and users that procedures, knowledge and training of the bridge personnel are related to the individual ship's bridge system, including the task and means defined below, for safe and efficient task performance. Such issues shall be documented in the company and ship specific bridge procedures manual and documented in the ISM Code procedures manual for the vessel (refer to 1.8.1, 1.8.2).

## 2.2 TYPE AND RANGE OF WORKSTATIONS

**2.2.1** The ship's navigating bridge shall not be used for purposes other than navigation, communications and other functions essential to the safe operation of the ship, its engines and cargo, and workplaces shall be arranged with the aim of:

facilitating the tasks to be performed by the bridge team and the pilot in making full appraisal of the situation and in navigating the ship safely under all operational conditions;

promoting effective and safe bridge resource management.

**2.2.2** Individual workstations for performance of primary bridge functions including conning position for pilotage shall be provided for:

navigating and maneuvering (and traffic surveillance);

monitoring;

manual steering;

docking on bridge wings;

planning (of voyage, routes, ship operations);

safety (monitoring and emergency operations);

communication (GMDSS);

conning (pilot) (refer also to Guidance note of 2.5.12);

### Guidance note.

The workstation for monitoring may be combined with:

a workplace for navigation (route monitoring/position-fixing) when the workstation for navigation and maneuvering provides individual workplaces for traffic surveillance and navigation (chart work);

a backup workstation for navigation and a conning position when electronic chart display and information system (ECDIS) is installed, enabling navigation, traffic surveillance and maneuvering at one workplace.

**2.2.3** Additional workstations may be arranged for performance of other functions than those related to primary bridge functions when relevant.

### Guidance note.

The main types of additional bridge workstations may be divided into two distinct categories (A and B)

based on purpose and functions and whether they shall be operated by the watch officer or not.

A. Workstations for functions regarded related to operation of the ship, its engines and cargo:

a) to be monitored and controlled by the watch officer;

b) to be used by other personnel than the watch officer.

B. Workstations for functions not regarded essential to safe operation of the ship and to be used by other personnel than the watch officer, but located on the bridge for practical reasons.

The type of tasks to be performed at the individual workstation and the operating procedures employed may conclude whether a workstation of category A shall be of type a) or b). Workstations of category A, type a) shall not include tasks that may prevent the officer in charge of primary bridge functions to leave a workstation for additional functions instantly at any time during operations.

Refer to 2.5.14 — 2.5.16.

## 2.3 WORKING ENVIRONMENT

**2.3.1** The bridge shall be designed and arranged with the aim of:

preventing or minimizing excessive or unnecessary work and any condition or distraction on the bridge, which may cause fatigue or interfere with the vigilance of the bridge team and the pilot.

Internal environmental conditions on the bridge that may affect human performance are:

temperature;

humidity;

ventilation;

noise;

vibration;

illumination and type of lighting;

glare and reflection;

interior colors;

occupational safety.

**2.3.2** The enclosed bridge or wheelhouse shall be equipped with an air conditioning or ventilation system for regulation of temperature and humidity.

### Guidance note.

It shall be possible to maintain a temperature, which is not less than 18 °C in cold climates and does not exceed 27 °C in tropical climates, and to maintain the relative air humidity in the range of 20 % — 60 %, preferably maintaining 45 % humidity at 21 °C and not less than 20 % at any temperature.

**2.3.3** Ventilation system with suitable air flow velocity and rate of air circulation shall be provided. Direction of air flow from air conditioning and heating systems towards workplaces shall be avoided.

**Guidance note.**

The preferred air velocity is 0,3 m/s and shall not exceed 0,5 m/s.

The recommended rate of air circulation for enclosed spaces is 6 complete changes per hour.

**2.3.4** Excessive levels of noise interfering with voice communication, causing fatigue and degrading overall system reliability, shall be avoided.

**Guidance note.**

The sound level measured 1 m from the outlets of air distribution systems shall not exceed 55 dB(A). Noise levels produced by individual bridge equipment shall not exceed 60 dB(A) at 1 m.

**2.3.5** Vibrations when the ship is at normal transit speeds shall not affect the reading of indicators or the comfort of personnel.

**2.3.6** Lighting arranged for adjustment of illumination and direction of light shall be provided at all workplaces. The illumination brightness shall be sufficient for safe performance of the tasks and possible to dim down to zero.

**2.3.7** Lighting that may be required for continuous operations during darkness and in entrances to the bridge shall be red with adjustable brightness to suit the operations and ease visual adaptation to darkness.

**2.3.8** It shall be possible to dim equipment displays and indicators providing information to individual workstations and red lighting covering the workstation area, at the workstation in use.

**2.3.9** Light sources shall be arranged and located in a way that prevents glare, stray image and mirror effects in bridge windows and deckhead areas above workstations.

**Guidance note.**

Deckhead areas above workstations shall have a dark colour of matt, anti-gloss type minimizing light reflection. The colour of bridge bulkheads shall have a calm and matt appearance.

**2.3.10** To reduce the risk of personnel injury during bridge operations:

the wheelhouse floor, bridge wings and upper bridge decks shall have non-slip surfaces;

hand- or grab-rails shall be installed as required at workstations, passageways and entrances, enabling personnel to move and stand safely when the ship is rolling and pitching in heavy weather;

chair deck rails installed at workstations shall be provided with anti-trip skirting board or be flush mounted;

stairway openings shall be protected if not sufficiently lit or otherwise indicated during darkness.

**2.3.11** Personnel safety equipment to be stored on the bridge shall be clearly marked and easily accessible.

**2.4 BRIDGE PASSAGEWAYS**

**2.4.1** Bridge passageways shall facilitate the expected movement of the bridge team between individual workstations, bridge entrances, exits and windows in carrying out the bridge tasks safely and effectively including the maintenance of equipment.

**2.4.2** A clear route across the wheelhouse, from bridge wing to bridge wing for two persons to pass each other, shall be provided.

**Guidance note.**

The width of the passageway shall be 1200 mm and not less than 700 mm at any single point of obstruction.

**2.4.3** The distance between separate workstation areas shall be sufficient to allow unobstructed passage for persons not working at the stations.

**Guidance note.**

The width of such passageways shall not be less than 700 mm, including persons sitting or standing at their workstations.

**2.4.4** The distance from the bridge front bulkhead, or from any console and installation placed against the front bulkhead to any console or installation placed away from the bridge front, shall be sufficient for one person to pass a stationary person.

**Guidance note.**

Where there is a passageway between the front bulkhead and front workstation consoles, its width shall preferably be 1000 mm and not be less than 800 mm. When the front workstation is placed against the front bulkhead, the guidelines of 2.4.2 may be applicable, or 2.4.3 if there is a passageway providing a clear route from bridge wing to bridge wing aft of the workstation.

**2.4.5** The distance between bridge wing consoles and bulkheads shall be as little as possible for easy operation of controls from both a position behind and beside the console giving optimum view of the ship's side and the mooring operations, but wide enough for one person to pass the console.

**Guidance note.**

The width of the passageway shall be 600 mm.

*Note.* The Panama Canal Commission (PCC) requires that a minimum of 1 meter clearance from consoles or obstructions shall be provided from the forward to aft portions of the bridge wing ends. Special requests for relaxation of this requirement may be considered on a case-by-case basis.

**2.4.6** The clear deckhead height in the wheelhouse shall take into account the installation of deckhead panels and instruments as well as the height of door openings required for easy entrance to the wheelhouse. The following clear heights for unobstructed passage shall be provided:

.1 the clear height between the bridge deck surface covering and the underside of the deck head covering shall be at least 2250 mm;

.2 the lower edge of deck head-mounted equipment in open areas and passageways, as well as the upper edge of door openings to bridge wings and other open deck areas shall be at least 2100 mm above the deck;

.3 the height of entrances and doors to the wheelhouse from adjacent passageways shall not be less than 2000 mm.

**2.5 WORKSTATION ARRANGEMENTS AND REQUIRED FIELDS OF VISION**

**2.5.1** The workstations for primary bridge functions shall be arranged to serve their functions under all operating conditions and different manning of the bridge and provide the fields of vision required for visual observations and easy cooperation between bridge personnel, promoting effective and safe bridge resource management.

**2.5.2** Workstations for navigating and maneuvering, including traffic surveillance and monitoring shall be arranged within an area spacious enough for two persons to carry out the tasks in close cooperation, but sufficiently close together to enable the watch officer to control and safely carry out all the tasks from one working area under normal operating conditions.

**Guidance note.**

The workstation for navigating and maneuvering shall be arranged to allow an assisting officer to carry out route monitoring, which may include position-fixing and chart work, and course adjustments when ordered, while the officer in charge concentrates on traffic situations and adjustment of course and speed as required to follow the route and avoid danger of collision.

The workplaces shall be adjacent to enable easy communication and cooperation when two navigators operate the workstation, and to provide the watch officer with a workstation for safe and efficient performance of all the tasks when he is the only navigator on the bridge and is to use both the workplace for route monitoring/position-fixing and the workplace for traffic surveillance/maneuvering.

*Note.* The workplace for position-fixing and chart work is regarded a workstation for monitoring also when in use by an assisting officer and may serve as a workplace for the use of backup chart systems and for conning when ECDIS is installed at the workplace for traffic surveillance.

The table shows the relative location of workplaces based on manual position-fixing in paper charts allowing efficient performance by the single watch officer under normal operating conditions and

two persons in close cooperation when the workload exceeds the capacity of the watch officer.

Workstation arrangement with work places for navigation and maneuvering — monitoring.

|   |                              |                      |
|---|------------------------------|----------------------|
| Position-fixing<br>Chart work<br>Monitoring | Alarms<br>Commun<br>Manoeuvr | Traffic surveillance |
|---|------------------------------|----------------------|

When an electronic chart system is installed, enabling route monitoring, traffic surveillance and maneuvering from one working position, the workplace for monitoring may be used by pilots for conning if located close to centre windows. Work places when arranged for the use of electronic chart system incorporating automatic position-fixing (ECDIS with backup):

|   |                              |   |
|---|------------------------------|---|
| Backup nav. system<br>Monitoring<br>Conning | Alarms<br>Commun<br>Manoeuvr | Traffic surveillance<br>Automatic pos.-fix. |
|---|------------------------------|---|

Workstation arrangement for navigation and maneuvering — monitoring — conning.

**2.5.3** Workplaces for performance of navigation, traffic surveillance and monitoring shall be arranged for working in standing as well as seated position with optimum field of vision.

**2.5.4** The field of vision from the bridge shall be provided, facilitating the tasks to be performed by the bridge team and the pilot in making full appraisal of the situation and in navigating the ship safely under all operating conditions by enabling visual observations for performance of bridge functions at the workstations specified in 2.2.

**2.5.5** It shall be possible to observe all objects of interest for the navigation such as ships and light-houses, in any direction from inside the wheelhouse by providing a horizontal field of vision to the horizon of 360° within the confines of the wheelhouse.

**Guidance note.**

On a bridge with enclosed bridge wings it shall be possible to obtain the view of 360° from inside the bridge area by using two positions, one on each side of the workstation for navigation and maneuvering, not being more than 15 m apart. This guideline may also be applicable for providing the required field of vision within the confines of wheelhouses with a total breadth of more than 18 meters.

**2.5.6** From the conning position and the workstation for navigating and maneuvering, the view of the sea surface forward of the bow to 10° on either side under any ballast or cargo condition shall not be obscured by more than 2 ship’s lengths or 500 meters, whichever is the less. Each individual blend sector shall not exceed 5°.

**2.5.7** The workstation for navigating and maneuvering and the conning position shall provide a field of vision enabling maintenance of visual traffic surveillance, extending over a forward arc of not less than  $225^\circ$  that is from right ahead to not less than  $22,5^\circ$ , abaft the beam on either side of the ship. From a workstation for monitoring, a blind sector covering the view abaft the beam on port side is accepted.

**Guidance note.**

All workstations to be used by the officer of the watch shall provide a forward field of vision of  $225^\circ$ . A blind sector covering the view abaft the beam on port side may be accepted for workstations to be used infrequently by the watch officer for short periods at a time and for workstations to be used by assisting officers.

**2.5.8** Workstations for monitoring, navigating and maneuvering shall provide the required fields of vision from a seated working position and shall not be located directly behind large masts, cranes etc., which obstruct the view right ahead from the workstation.

**2.5.9** A separate blind sector formed by the ship's cargo, cargo lifting equipment or another obstacle forward of (in  $180^\circ$  sector) the ship's wheelhouse and restricting the sea surface scanning from the workstation shall not exceed  $10^\circ$ . The resulting blind sector shall not exceed  $20^\circ$ . The sectors of unrestricted observation area between blind sectors shall be at least  $5^\circ$ . However, for the scanning described in 2.5.6 of this Appendix, each separate blind sector shall not exceed  $5^\circ$ .

**Guidance note.**

To help reducing the size of internal blind sector caused by bridge wing bulwarks and divisions between windows in bridge wing bulkheads, such bulwarks and bulkheads shall be located in a line of sight seen from the working position at the front workstations.

**2.5.10** The workstation for manual steering shall preferably be located on the ship's centre line and shall not interfere with the functions to be performed by the officer of the watch. The steering position shall provide a forward field of vision not less than  $60^\circ$  to each side. If large masts, cranes, etc. obstruct the view in front of the workstation, it shall be located some distance to starboard of the centre line, sufficiently to obtain a clear view ahead.

**2.5.11** When the workstation for manual steering is located off centre, or the bow of the ship cannot be seen from the steering position, special steering references (sighting marks) shall be installed forward of the steering position. The steering references shall be installed in line parallel to the ship's centre line for use by day and by night.

**2.5.12** The ship's side shall be visible from the bridge wing. Equipment for docking operations from the bridge wings, or a workstation console if

installed, shall be located to enable visual observations required for safe maneuvering of the ship, monitoring of tug and mooring operations and shall provide a field of vision from not less than  $45^\circ$  on opposite bow to right astern from the working position as shown in Fig. A.

*Note.* The Panama Canal Commission (PCC) requires that the conning position located at the extreme end of the bridge wings provides a clear and unobstructed view fore and aft of the vessel's side. The side hull plating at the vessel's waterline, fore and aft, shall be visible from bridge wing conning positions.

**2.5.13** The conning position shall be located close to the front centre window to provide the pilot with a commanding external view, including a view of the sea surface sufficiently close to both sides of the ship's bow for safe directing of the steering in narrow canals and buoy lanes.

**Guidance note.**

The position for the conning station may be met by the workstation for monitoring/backup navigation when located sufficiently close to the forward centre window, provided the workstation is installed in addition to a complete workstation for navigation, traffic surveillance and maneuvering and therefore not required by the ship's personnel during pilotage (refer to Guidance notes of 2.2.2).

*Notes:* 1. The Panama Canal Commission (PCC) requires that the conning position be located "directly behind and next to" the centre front window and the nearest window thereto on each side that provides a clear and unobstructed view ahead for conning during canal transit. A minimum of 1 meter clearance from consoles or obstructions shall be provided. Special requests for relaxation of this requirement may be considered on a case-by-case basis.

2. PCC requires that the conning position shall provide a view of the sea surface forward of the bow from 1,5 ship's length when at ballast load line and 1 ship's length at full load line.

**2.5.14** There shall be a close approach access to at least one front window providing the view of the area in front of the bridge superstructure.

**2.5.15** Workstations for additional functions, which shall be used by the watch officer (refer to 2.2.2), shall provide the field of vision required to maintain efficient look-out in accordance with 2.5.6 and enable monitoring of the ship's heading and rudder angle.

**2.5.16** The location of a workstation for additional functions regarded essential for safe operation of the ship and to be used by other personnel than the watch officer shall not in any way influence the performance of primary bridge functions.

**2.5.17** Workstations for additional functions not essential to the safe operation of the ship, its engines and cargo, or furniture arranged for meetings or relaxation inside the wheelhouse shall not be installed within the area of the navigating bridge or within fields of vision outside this area, which are required

for traffic surveillance from workstations. If such workstation or furniture arrangement is installed close to these areas, the use of it shall in no way influence the performance of primary bridge functions, either by use of light, noise disturbance or visual distraction.

**Guidance note.**

Figure 2.5.17-1 shows the principles for bridge layout with front workstations arranged for operations in seated and standing position and with bridge wing bulkheads in line of sight from the working positions. A bridge area, which may be regarded outside the navigating bridge, and the sectors of

required field of vision from workstations are indicated.

Position-fixing in paper charts — passageway and conning position in front.

Note to Fig. 2.5.17-2 (also valid for Fig. 2.5.17-3).

Location of ECDIS at the workstation for navigating and maneuvering (including traffic surveillance) enables position-fixing at this position and makes the area a complete workstation (WS) for the navigation function and maneuvering. This leaves the workstation for navigation backup/monitoring available for conning when installed at the front bulkhead. Close approach access to front windows is maintained.

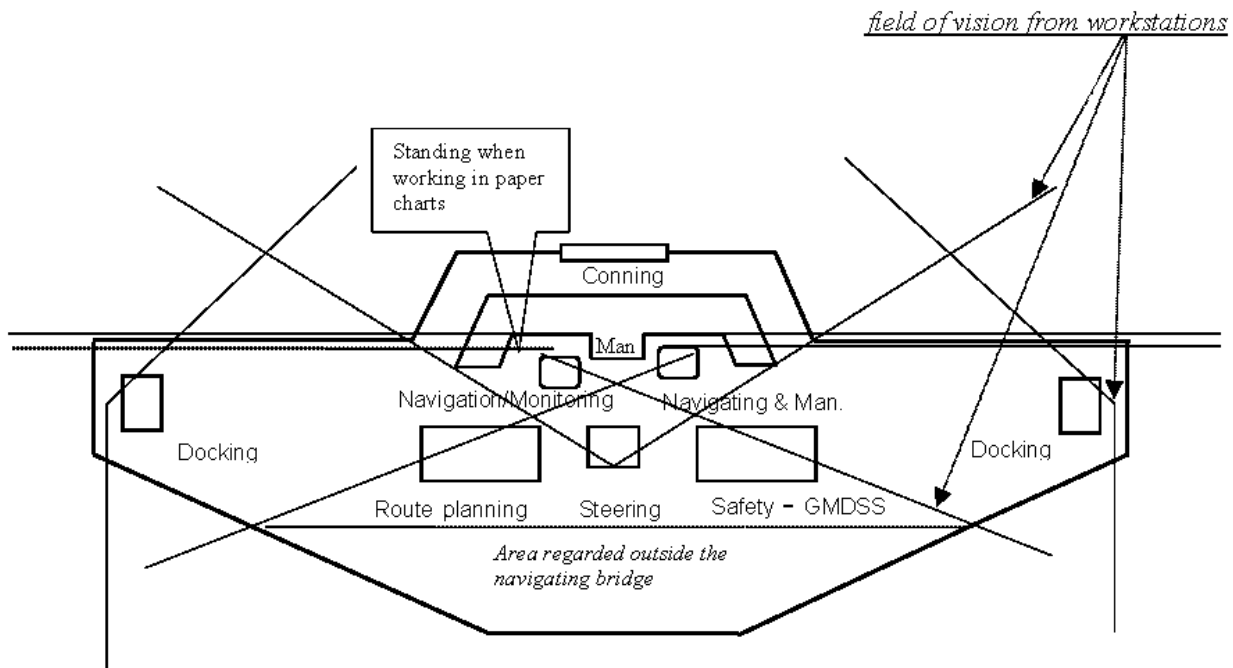

Fig. 2.5.17-1 Location of workstations and required fields of vision. Position-fixing in paper charts - Passageway and conning position in front

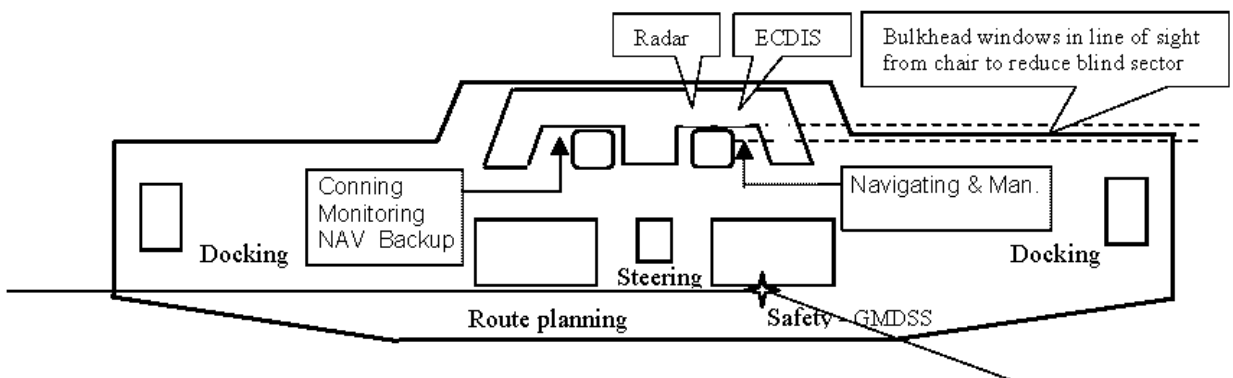

Fig. 2.5.17-2 Required field of vision from the radio station when to be controlled and infrequently used for short periods of time by the watch officer. Navigation based on electronic chart system (ECDIS) – Conning position at console

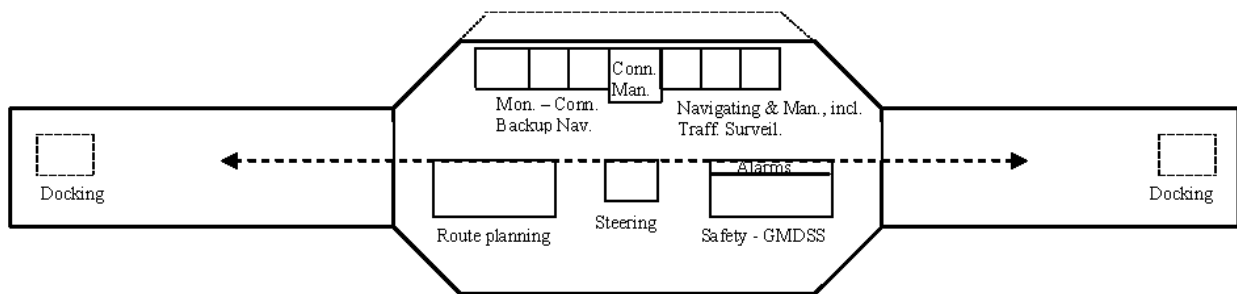

Fig. 2.5.17-3 Design principles — Flat front — Open bridge wings with passageway from door to door  
Consoles up front — Access to front window

## 2.6 FIELDS OF VISION AND BRIDGE WINDOW ARRANGEMENT

**2.6.1** The bridge front windows shall be inclined from the vertical plane, top out, at an angle not less than  $10^\circ$  and not more than  $25^\circ$  to help avoid reflections. Polarized and tinted windows shall not be fitted.

### Guidance note.

The rear and side windows shall be inclined from the vertical plane top out, at an angle of  $4^\circ$  —  $5^\circ$  to help avoid reflections. If the arrangement of light sources meet the requirement of paragraph 2.3.9 without inclination of the side and rear windows, inclination may not be necessary.

*Note.* Bridges designed with enclosed bridge wings: inclined side windows, which extend the maximum breadth of the ship, may not be in accordance with requirements of the Panama Canal Commission for some ship sizes.

**2.6.2** The lower and upper edge of windows shall not present an obstruction to the view forward of the

bow seen from a seated as well as a standing position at the workstations for monitoring, navigating and maneuvering.

### Guidance note.

The height of the lower edge of windows above the floor surface shall not exceed 1000 mm within the required field of vision and the height of the upper edge shall be at least 2000 mm.

**2.6.3** The upper edge of the front windows shall allow a forward view of the horizon for a person with a height of eye of 1800 mm at the navigating and maneuvering workstation when the ship is pitching in heavy seas. If 1800 mm height of eye is considered unreasonable and impractical, a reduction of the height may be accepted, but not to less than 1600 mm.

### Guidance note.

A vertical angle of view of not less than  $5^\circ$  above a horizontal line from a standing eye height of 1750 mm shall be provided (Fig. 2.6.3).

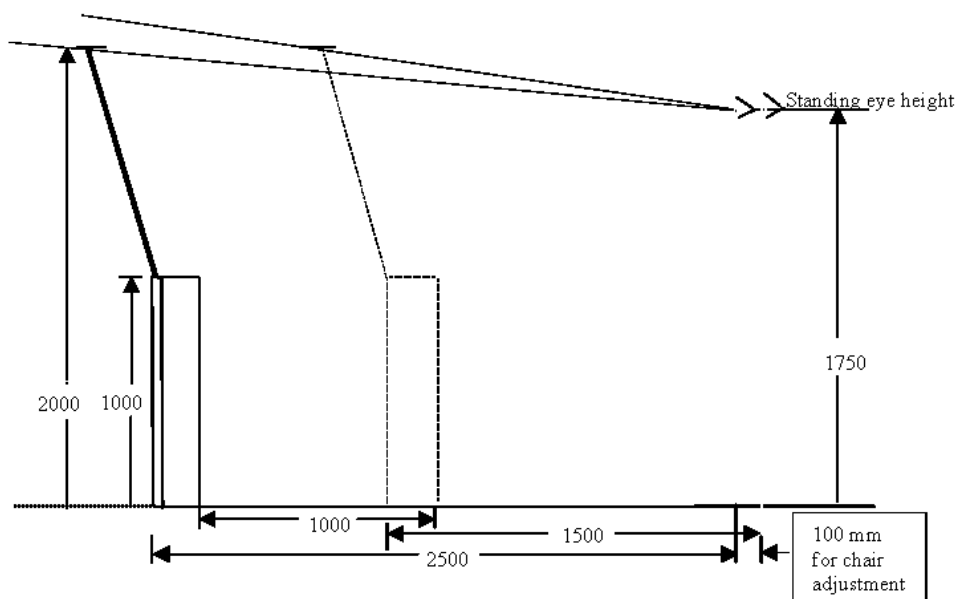

Fig. 2.6.3 With front windows at an angle of  $15^\circ$ , a vertical angle of view of  $5^\circ$  from an eye height of 1750 mm may be provided at a distance of 2600 mm from the front bulkhead, allowing for a passageway of 1000 mm in front of workstation consoles

**2.6.4** Framing between windows shall be kept to a minimum and not be installed immediately forward of any workstation. If stiffeners between windows shall be covered, this shall not cause further obstruction of the view.

**Guidance note.**

The division between windowpanes within the required field of vision shall not exceed 150 mm. If stiffeners are used, divisions shall not exceed 100 mm in width and 120 mm in depth. The width of windowpanes within the field of vision required for traffic surveillance shall not be less than 1200 mm in order to limit the number of stiffeners.

**2.6.5** To enable visual observations through windows to be maintained under all weather conditions, all windows within the required fields of vision from the working position at workstations to be used by bridge personnel, including pilots, shall provide a clear view regardless of weather conditions.

**Guidance note.**

The following means shall be installed to provide a clear view through windows:

- sunscreens of roller blind type;
- heavy duty blade type wipers and fresh water window washing;
- efficient de-icing and de-misting systems.

Technical systems installed shall comply with appropriate ISO standards (refer to ISO standard 17899).

A catwalk or other means to help maintenance of window wipers and manual cleaning of bridge front windows shall be provided.

## 2.7 WORKSTATION LAYOUT, CONSOLES AND CHAIR ARRANGEMENT

**2.7.1** The configuration of workstations and consoles shall provide a workplace for rational and user-friendly placing of equipment, with the aim of:

- facilitating the tasks to be performed by the bridge team and the pilot in making full appraisal of the situation and in navigating the ship safely under all operational conditions;
- promoting effective and safe bridge resource management;
- enabling the bridge team and the pilot to have convenient and continuous access to essential information;
- allowing for expeditious, continuous and effective information processing and decision-making by the bridge team and the pilot;
- preventing, or minimizing, excessive or unnecessary work and any condition or distractions on the bridge, which may cause fatigue or interfere with the vigilance of the bridge team and the pilot.

**2.7.2** A functional workstation designed in accordance with the established overall operational and ergonomic requirements shall provide:

- a sufficient area for performance of the tasks to be carried out by the number of people that may be required to attend consoles designed for operations at specific workplaces in standing and seated position;
- enabling installation of equipment to be within reach from the working position;
- avoiding obstruction of the view through bridge windows from seated position;
- chairs suiting ergonomic requirements for efficient use of installed equipment and maintenance of fields of vision, if chairs shall be installed.

**2.7.3** The workstation for navigation and maneuvering shall have working positions for position-fixing, maneuvering and traffic surveillance as close as possible for efficient use by the officer of the watch, but also enabling the tasks to be performed by two navigators in close cooperation.

**Guidance note.**

The working position for operating the radar with collision avoidance functions shall be regarded the main working position at this workstation. Controls for course and speed adjustments shall be located within reach from this position to enable collision avoidance maneuvers without losing view of the traffic, and means for position-monitoring/-fixing shall be readily available.

Figures 2.7.3-1 and 2.7.3-2 show examples of workstation layouts designed in compliance with 2.5.2. If ECDIS with backup (which is optional) is not installed, the chart table shall preferably be installed closer to the radar (refer to Fig. 2.7.3-3). Alternatively, spaces may be allocated for future ECDIS installation.

May suit wheelhouses with limited depth (longitudinal distance between front and rear bulkheads).

Includes space for conning information display and machinery monitoring system.

**2.7.4** Consoles shall principally be divided into two areas:

- a vertical (slanting) part for location of information displays to be easily readable;
- a horizontal part (desktop) for controls, switches and buttons to be within easy reach from the working position.

**2.7.5** The height of console desktops at the workplaces for navigation, maneuvering, traffic surveillance and monitoring shall enable easy use of equipment required for safe performance of the tasks to be performed from both standing and sitting position.

**Guidance note.**

To provide a functional reach from standing position, the height of console desktops above bridge

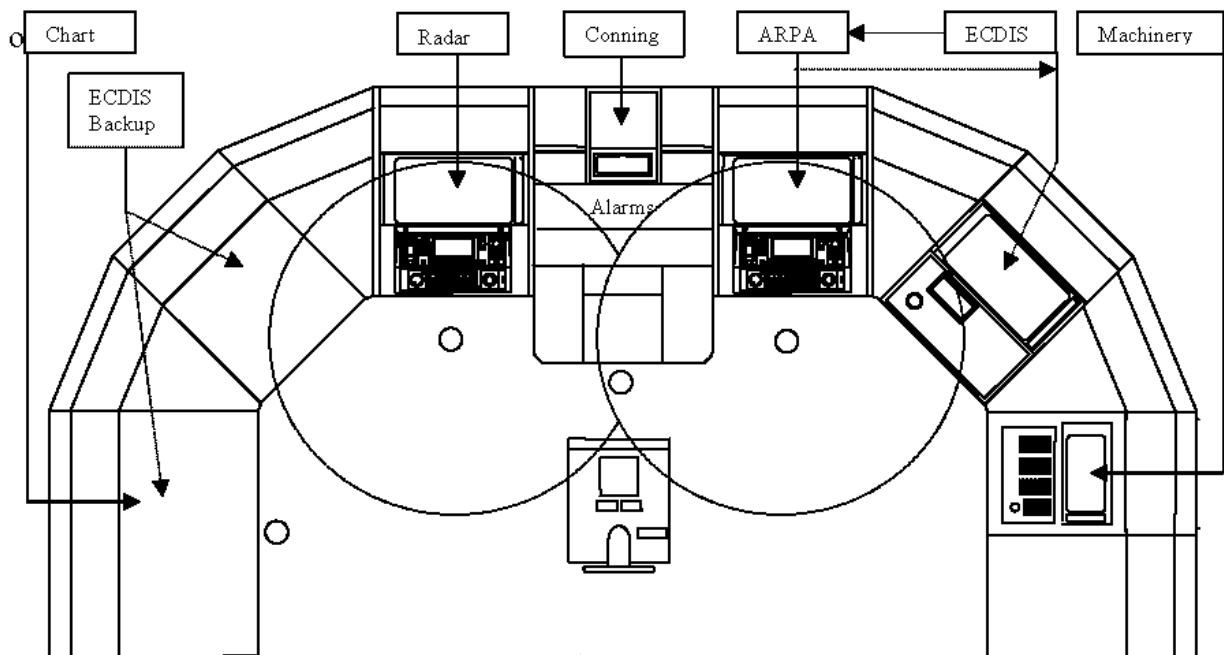

Fig. 2.7.3-1

Workstation layout which may include ECDIS with combined electronic and paper chart back up arrangement as well as conning information display monitoring of INS functions

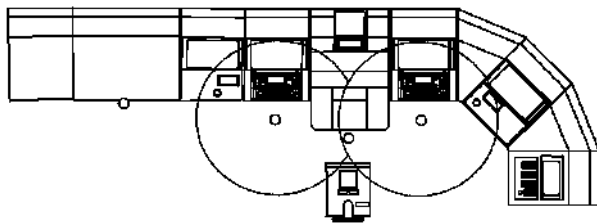

Fig. 2.7.3-2 A modified workstation configuration, based on same principles as shown in Fig. 2.7.3-1.

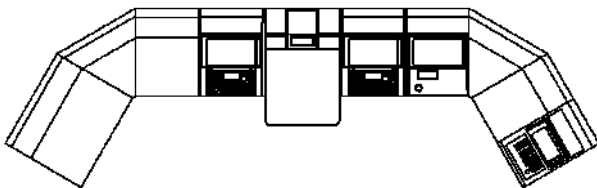

Fig. 2.7.3-3 A modified version of Fig. 2.7.3-1

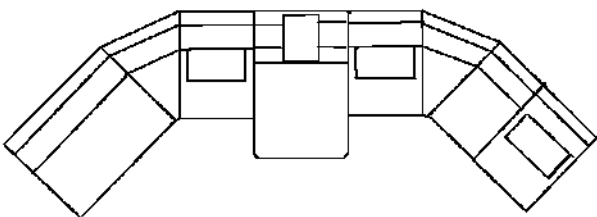

Fig. 2.7.3-4 Design principles similar to Fig. 2.7.3-3, but without electronic chart installations

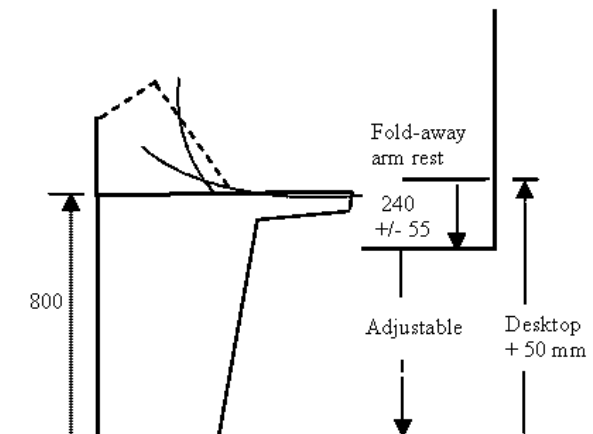

Fig. 2.7.5

To provide a functional reach of equipment and easy operation of controls from sitting position the elbow height of the operator shall be preferably 50 mm higher than the console desktop and not less than the height of the desktop.

To provide the elbow height for persons of different size and build in relation to the console desktop, it shall be possible to adjust the height of the seat to allow the elbow height of 240 mm  $\pm$  55 mm above seat. It shall be possible to adjust chair armrests accordingly, if installed, and to fold the armrests away.

**2.7.6** The console in front of a seated working position shall provide sufficient leg room.

deck surface shall be 800 mm and not less than 750 mm. The sitting height is governed by the elbow height in relation to console desktop.



**Guidance note.**

The leg room shall have a depth of 450 mm and not less than required for a person sitting at a working position 350 mm from the console (chair backrest 440 mm from the edge of the console, requiring a leg room depth of at least 230 mm).

**2.7.7** The consoles forming the front workstations shall not be higher than required for efficient use in standing position and shall not obstruct the fields of vision over the lower edge windows in front of the workstation from sitting position.

**Guidance note.**

The console height shall not exceed 1200 mm. This console height may be accepted for installation at a distance of 350 mm or more from the window, also if it interferes with the line of sight from an eye height of 1400 mm, providing the height of the chair can be adjusted to compensate for the interference.

Note. Refer to 2.6.3 for eye heights at standing position.

**2.7.8** Consoles within the required fields of vision aft of the front workstation consoles shall not obstruct the horizontal line of sight from the sitting eye height.

**Guidance note.**

The height of the consoles shall be 100 mm lower than the horizontal line of sight and shall not exceed 1300 mm.

**2.7.9** When a chair is installed at a workplace for operations in both standing and seated position, it shall be fastened to rails allowing fore and aft movement of the seat to enable easy reach of equipment when seated and sufficient room to stand in front of the console when the chair is pushed back. It shall be possible to adjust the height of the seat to suit users of different heights for optimum view and reaching distance and armrests, if provided, shall be of fold away type and preferably adjustable in height.

**Guidance note.**

The seat height of the chair shall be adjustable from 550 to 670 mm above the deck surface. The movement in fore-aft direction shall allow the front edge of the seat to be positioned at the edge of the front console and to allow a free space of at least 700 mm between the chair and console when moved in aft direction. Armrests shall preferably be adjustable from 185 and 295 mm above the seat, if installed.

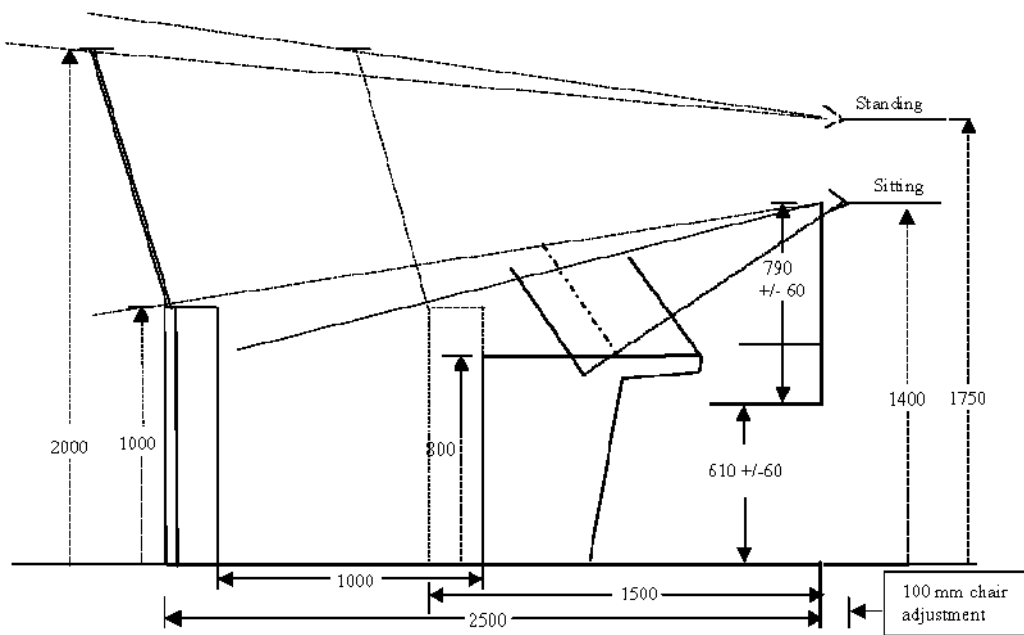

Fig. 2.7.8

### 3 DESIGN AND ARRANGEMENT OF NAVIGATIONAL SYSTEMS AND EQUIPMENT

Navigational systems and equipment shall be designed with the aim of:

presenting the information in a clear and unambiguous manner, using standardized symbols and coding systems for controls and displays;

indicating the operational status of automated functions and integrated components, systems and/or sub-systems;

minimizing the risk of human error and detecting such error if it occurs, through monitoring and alarm systems, in time for the bridge team and the pilot to take appropriate action;

and be arranged with the aim of:

facilitating the tasks to be performed by the bridge team and the pilot in making full appraisal of the situation and in navigating the ship safely under all operational conditions;

enabling the bridge team and the pilot to have convenient and continuous access to essential information;

allowing for expeditious, continuous and effective information processing and decision-making by the bridge team and the pilot.

#### 3.1 DESIGN AND QUALITY OF NAVIGATIONAL SYSTEMS AND EQUIPMENT

**3.1.1** Navigational systems and equipment shall be of approved type and comply with the applicable international requirements and requirements of the Register Rules.

*Note.* The basic design of navigational systems and equipment required to be carried is governed by functional and technical requirements as well as ergonomic and human-machine interface criteria expressed in individual IMO performance standards.

The quality of the human engineering part of the design of equipment and alarm functions shall be determined in performance tests and trials carried out during the approval process.

Alteration of hardware and software of type approved equipment requires review of the documentation by the type approving authority and may include re-testing to a certain extent, depending on the type of changes.

**3.1.2** Navigational equipment and systems offering alternative modes of operation shall indicate the actual mode in use.

**3.1.3** The system architecture of an integrated system shall include means providing situation awareness by indication of operational status of automated functions and the individual equipment.

**3.1.4** In case of failure in one part of an integrated navigational system, it shall be possible to operate every other individual item of equipment or part of the system separately.

#### 3.2 BRIDGE ALARM MANAGEMENT

**3.2.1** An alarm system shall be provided, indicating any fault requiring attention and shall:

activate an audible and visual alarm on the navigating bridge for any situation, which requires action by, or attention of the officer of the watch;

as far as practicable be designed on the self-monitoring principle.

The bridge alarm system shall be designed with the overall aim of:

minimizing the risk of human error and detecting such error, if it occurs, through monitoring and alarm systems, in time for the bridge team and the pilot to take appropriate action.

The overall aim includes the aim of:

enabling the officer on watch to devote full attention to the safe navigation of the ship enabling immediate identification of any abnormal situation requiring action to maintain safe navigation of the ship;

avoiding distraction by alarms, which require attention but have no direct influence on the safe navigation of the ship and which do not require immediate action to restore or maintain the safe navigation of the ship.

Alarms and indicators on the navigating bridge shall be minimized and only alarms and indicators required by appropriate documents shall be placed on the navigating bridge, unless permitted by the flag administration (refer to IMO resolution A.830(19)).

**3.2.2** A method of accepting all alarms on the bridge (both the source of alarm and alarms of other equipment caused by the loss of sensor input) shall be provided at the navigating and maneuvering workstation to avoid distraction. The system shall enable immediate identification of the alarm sources without requiring any operator action and enable immediate silencing of the alarms by single operator action.

##### **Guidance note.**

A bridge management system shall include grouping of alarms and indicators, separating alarms that affect safety of navigation and alarms that do not influence safety of navigation.

The group of alarms related to safety of navigation shall incorporate all system alarms, equipment alarms and operational warnings that are critical to safety of navigation, including the detection of:

operator disability;  
danger of collision heading;  
heading deviations;  
deviations from the route;

danger of grounding;  
propulsion failure;  
steering gear failure.

Essential equipment and systems to be incorporated in such an alarm system shall include:

bridge watch monitoring system;  
heading information system;  
heading/track control system;  
position-fixing systems;  
electronic chart system, if installed;  
radar with electronic target plotting functions;  
relevant machinery alarms for early warning.

All groups of bridge alarms and warnings shall be centralized in a common panel or screen at the workstation for navigation and maneuvering.

**3.2.3** Acknowledgement of an alarm at either the instrument or an alarm panel shall cancel the audible warning at both sources and change the visual alarm from flashing to constant light.

**3.2.4** Permanently inhibiting individual alarms shall not be possible, but manual suppression of local audible alarms may be accepted when this is clearly and constantly indicated at the equipment and the unit is part of the alarm management system.

**Guidance note.**

Local audible alarms may be manually suppressed by means of an on/off switch located on or close to the equipment or by other means, e.g. electronically. The off-position shall enable suppression of the audible alarm when the equipment is part of a central alarm system and the on-position shall engage the local alarm when the equipment serves as a stand-alone unit.

**3.2.5** If an alarm channel in a computer-based system is inhibited manually, then this shall be clearly indicated by a visual signal.

**3.2.6** Audible alarms shall be maintained until they are accepted and the visual identification of individual alarms shall remain until the fault has been corrected.

**3.2.7** Alarm indications shall be red, or if on displays, red or otherwise highlighted. If alarm messages are displayed on color VDUs, the alarm status shall remain visible in the event of the failure of one color of the display system.

**Guidance note.**

The following method of indication shall be applied:

- .1** active alarm status:  
red, blinking and audible;
- .2** active alarm status acknowledged:  
red, static (canceling the audible alarm);
- .3** active warning message — not critical:  
yellow, static (may be accompanied by a short audible attention signal);
- .4** normal condition:  
no light (indication of a safe situation).

**3.2.8** The alarm system shall be able to indicate more than one fault at the same time, and the acknowledgement of any alarm shall not inhibit another alarm, meaning that if an alarm has been acknowledged and a second fault occurs before the first is rectified, the audible and visual alarms shall operate again.

**3.2.9** A new alarm condition shall be clearly distinguishable from those existing and already acknowledged by indicating new alarms by a flashing light, and existing and accepted alarms by a constant light.

**Guidance note.**

In colour graphic systems, it shall not be possible to distinguish between the status of alarms and warnings by means of colour only.

**3.2.10** Provisions shall be made for functional testing of required alarms and indicators.

**3.2.11** The alarm system shall be continuously powered and shall have an automatic changeover to stand-by power supply in case of loss of normal power supply.

**3.2.12** Failure of the normal or backup power supply of the alarm system shall be indicated by an alarm.

**3.2.13** Loss of system communication shall be indicated by an alarm.

### 3.3 ARRANGEMENT OF NAVIGATIONAL SYSTEMS AND EQUIPMENT

**3.3.1** The type and number of navigational systems and equipment to be carried shall at least incorporate the items specified in the present Part of the Rule Standard, and shall be installed at the various workstations with the aim of:

facilitating the tasks to be performed by the bridge team and the pilot in making full appraisal of the situation and in navigating the ship safely under all operational conditions;

enabling the bridge team and the pilot to have convenient and continuous access to essential information that is presented in a clear and unambiguous manner, using standardized symbols and coding systems for controls and displays;

indicating the operational status of automated functions and integrated components, systems and/or sub-systems;

minimizing the risk of human error and detecting such error if it occurs through monitoring and alarm systems, in time for the bridge team and the pilot to take appropriate action.

The relative location of individual equipment and their placement in relation to the distance from the working position of the user are governed by:

type and range of equipment to be installed (refer to Guidance note of 3.3.2);

equipment relationship with tasks to be performed at the various workstations (refer to Guidance note of 2.1 and 3.3.1);

importance of equipment functions and frequency of use (refer to 2.1);

workstation and console configurations (refer to 2.7);

size of equipment and space available for installation (case by case).

**3.3.2** All information, controls, facilities and fields of vision required to carry out each of the tasks safely and efficiently shall be provided at the corresponding workstations.

**Guidance note.**

The table specifies minimum carriage requirements for ships of different tonnage, the tasks or the purpose the equipment shall serve and the type of workstation (WS), at which the equipment shall be used and shall be installed. Refer also to table 2.1.1 specifying equipment in relation to functions and tasks.

Workstation for navigating and maneuvering.

**3.3.2.1** Installation of voyage data recorder (VDR).

To assist in casualty investigations, ships, when engaged on international voyages shall be fitted with a voyage data recorder (VDR).

**3.3.3** Other means than those specified in 3.3.1 may be permitted, provided they serve the same functions and are approved.

**3.3.4** The location of equipment at the workplaces for navigation, maneuvering, traffic surveillance and monitoring shall enable:

easy use of all controls, switches and buttons from standing position;

easy use of primary means for route monitoring; traffic surveillance;

heading and speed adjustments;

internal and external communication, including ship's whistle;

change of steering mode, from seated position.

Work in paper charts and maneuvering requiring the use of lateral thrusters may be performed in standing position only, but controls for thruster systems shall be grouped with controls for propulsion and manual steering.

**Guidance note.**

The position for operation of radars and the position at the centre console for harbor maneuvers are regarded the main working positions at the workstation for navigation and maneuvering. Figure 3.3.4 indicates location of main categories of equipment that shall be within reach from the front workstation comprising three workplaces. Examples of location of primary equipment are shown in Annex 2.

Table 3.3.2

| <b>Workstation for navigating and manoeuvring</b>   |   |                   |                        |   |
|---|---|-------------------|------------------------|---|
| Main functions: Position surveillance, traffic surveillance, course alterations and speed changes |   |                   |                        |   |
| <b>Equipment and means</b>  |   |                   |                        |   |
| <i>Task/Purpose</i>   | <i>Equipment</i>  | <i>Indicators</i> | <i>Related equipm.</i> | <i>Remarks</i>                                    |
| <i>Other means</i>  |   |                   |                        |   |
| <b>Applicable for all ships</b>   |   |                   |                        |   |
| Check heading   | Magnetic compass <sup>1</sup>   |                   |                        | <sup>1</sup> Readable from WS for manual steering |
| Take optical bearings   | Pelorus<br>Means of correcting heading and bearing to true              |                   | Magnetic compass       | Arc of 360°                                       |
| Positioning<br>- manual<br><br>- electronic <sup>1</sup>  | GNSS<br>Paper charts<br>Chart table<br>ECDIS w/backup arr. <sup>1</sup> |                   |                        | <sup>1</sup> Optional chart system                |
| Surveillance by hearing   | Sound reception system  | Sound direction   |                        | All ships w/ totally enclosed bridge              |

Table 3.3.2 — continued

| Workstation for navigating and manoeuvring                               |   |                                       |                                   |   |
|--|---|---------------------------------------|-----------------------------------|---|
| Communicate heading <sup>1</sup><br>- manual<br>- automatic <sup>2</sup> | Telephone   |                                       | <sup>2</sup> Main gyro (optional) | <sup>1</sup> To emergency steering position<br><sup>2</sup> Optional Gyro repeater (located in steering gear comp.) |
| <b>Applicable for ships ≥ 150gr.t</b>                                    |   |                                       |                                   |   |
| Spare compass  | Interchangeable magnetic compass (or other means) |                                       |                                   | Stored in bridge area<br>Gyro compass also connected to emergency source of electrical power may be accepted.       |
| Communicate ship/shore   | Signalling lamp                                   |                                       |                                   | Readily available   |
| <b>Applicable for ships ≥ 300gr.t.</b>                                   |   |                                       |                                   |   |
| Traffic surveillance<br>Navigation                                       | Radar with electronic plotting aid (EPA)          |                                       |                                   | 9 GHz   |
| Check keel clearance   | Echo sounding device                              |                                       |                                   |   |
| Check speed & distance   | Speed & distance measuring device                 |                                       |                                   | Speed through the water   |
| Transmitting heading <sup>1</sup>  | Transmitting heading device <sup>2</sup>          |                                       |                                   | <sup>1</sup> Trans. to Radar/EPA and AIS<br><sup>2</sup> Gyro required for ships > 500 gr.t.                        |
| Ship identification, tracking  | AIS   |                                       |                                   |   |
| External communication   | VHF telephone                                     |                                       |                                   |   |
| <b>Applicable for ships ≥ 500gr.t.</b>                                   |   |                                       |                                   |   |
| Determine heading<br>Transmitting heading <sup>2</sup>                   | Gyro compass                                      | Gyro heading repeater                 |                                   | <sup>1</sup> Also available to WS for monitoring<br><sup>2</sup> Trans. to Radar/ATA and AIS                        |
| Take bearings – arc 360°   |   | 2 gyro bearing repeaters <sup>1</sup> | Main gyro                         | <sup>1</sup> Location bridge wings  |
| Supply heading info to emergency steering pos.                           |   | Gyro heading repeater <sup>1</sup>    | Main gyro                         | <sup>1</sup> Located at emerg. steering position  |
| Manoeuvring<br>- rudder angle  |   | Rudder angle                          |                                   | Readable also from WSs for monitoring + manual steering   |
| - RPM  |   | RPM/(Pitch)                           |                                   | Readable also from WS for monitoring  |
| - thruster force + direction   |   | Thruster settings                     |                                   |   |
| - operational mode   |   | Actual mode of use                    |                                   | When equipment offers diff. modes   |
| Traffic surveillance   | ATA <sup>1</sup>                                  |                                       | Radar                             | <sup>1</sup> Replaces EPA   |
| <b>Applicable for ships ≥ 3000gr.t</b>                                   |   |                                       |                                   |   |
| Traffic surveillance<br>Navigation                                       | Radar with ATA                                    |                                       |                                   | 3GHz or 9GHz<br>(Add a second radar with ATA)   |
| <b>Applicable for ships &gt; 10000gr.t.</b>                              |   |                                       |                                   |   |
| Traffic surveillance   | Automatic radar plotting aid (ARPA) <sup>1</sup>  |                                       | Radar                             | <sup>1</sup> Replaces one ATA   |
| Automatic steering   | Heading or track control system                   |                                       |                                   |   |
| <b>Applicable for ships ≥ 50000gr.t.</b>                                 |   |                                       |                                   |   |
| Monitor ship's turn  |   | Rate-of-turn                          |                                   | To be read from WS for monitoring + manual steering   |
| Measure speed & dist. forward + athwartship                              | 2-axis speed log                                  |                                       |                                   | Over ground   |

Table 3.3.2 — continued

| Workstation for navigating and manoeuvring |                     |  |  |  |
|--|---------------------|--|--|--|
| Internal com.                              | Auto telephone.     |  |  |  |
| External com.                              | VHF telephone       |  |  |  |
| Monitor alarms and warnings                | Alarm panel         |  |  | Enabling accept of alarms and warnings |
| Accept watch alarms                        | Alarm accept button |  |  | Watch monitoring                       |

| Workstation for monitoring   |   |   |                       |  |
|--|---|---|-----------------------|--|
| Main functions: Observation of bridge operations and surrounding environment – Assisting OOW |   |   |                       |  |
| Equipment and means  |   |   |                       |  |
| <i>Task/Purpose</i>  | <i>Equipment</i>  | <i>Indicators</i>                             | <i>Related equip.</i> | <i>Remarks</i>                         |
| Monitor Steering   |   | Gyro repeater<br>Rudder angle<br>Rate-of-turn | Main gyro             | See WS for navigation and manoeuvring  |
| Monitor Speed  |   | Speed<br>RPM main engine                      | Speed log             | See WS for nav./man. Pitch if relevant |
| Monitor time   |   | Clock   |                       |  |
| Give sound signals   | Whistle control   |   |                       |  |
| Accept watch alarms  | Alarm accept button                                       |   |                       | Watch monitoring                       |
| Internal com.  | Telephone   |   |                       |  |
| External com.  | VHF telephone   |   |                       |  |
| Monitoring environment   | Ctrls. for window wipers, washing & heating<br>Binoculars |   |                       |  |

| Workstation for Manual steering  |                                |                                  |                               |                |
|--|--------------------------------|----------------------------------|-------------------------------|----------------|
| Main functions: Steering in accordance with compass heading and visual marks |                                |                                  |                               |                |
| Equipment and means  |                                |                                  |                               |                |
| <i>Task/Purpose</i>  | <i>Equipment</i>               | <i>Indicators</i>                | <i>Related equip.</i>         | <i>Remarks</i> |
| Operating steering device  | Wheel - tiller                 |                                  |                               |                |
| Monitoring compass heading   |                                | Compass heading<br>Gyro repeater | Magnetic compass<br>Main gyro |                |
| Communicate bridge wings   | Hands free talk-back telephone |                                  |                               |                |

| Workstation for Docking  |  |  |                        |                           |
|--|--|--|------------------------|---------------------------|
| Main functions: Conning, course alterations, speed changes, mooring operations |  |  |                        |                           |
| Equipment and means  |  |  |                        |                           |
| <i>Task/Purpose</i>  | <i>Equipment</i>   | <i>Indicators</i>  | <i>Related equip.</i>  | <i>Remarks</i>            |
| Determine manoeuvring<br>- Heading<br>- Speed<br>- Steering<br>- Propulsion    |  | Gyro repeater<br>Speed<br>Rudder angle<br>RPM<br>Pitch if relevant | Main gyro<br>Speed log |                           |
| Manoeuvring operations   | Main engine control <sup>1</sup><br>Steering control <sup>1</sup><br>Thruster control <sup>1</sup> |  |                        | <sup>1</sup> If installed |
| Monitor external conditions  |  | Wind speed & direction *   |                        | * Optional installation   |
| Communicate wheelhouse   | Handsfree talk-back telephone  |  |                        |                           |
| Communicate tugs/pilot   | VHF (point)  |  |                        |                           |

Table 3.3.2 — continued

| <b>Workstation for Docking</b>   |                  |                   |                       |                |
|--|------------------|-------------------|-----------------------|----------------|
| Main functions: Conning, course alterations, speed changes, mooring operations |                  |                   |                       |                |
| Equipment and means  |                  |                   |                       |                |
| <i>Task/Purpose</i>  | <i>Equipment</i> | <i>Indicators</i> | <i>Related equip.</i> | <i>Remarks</i> |
| boats  |                  |                   |                       |                |

| <b>Workstation for planning and documentation</b>            |                                    |                   |                       |                |
|--|------------------------------------|-------------------|-----------------------|----------------|
| Main functions: Route planning – documenting ship operations |                                    |                   |                       |                |
| Equipment and means  |                                    |                   |                       |                |
| <i>Task/Purpose</i>  | <i>Equipment</i>                   | <i>Indicators</i> | <i>Related equip.</i> | <i>Remarks</i> |
| Route planning   | GNSS<br>Paper chart<br>Chart table |                   |                       |                |
|  | Electronic chart                   |                   |                       | Optional       |

| <b>Workstation for Safety operations</b>   |   |  |                       |   |
|--|---|--|-----------------------|---|
| Main functions: Monitor safety state - Execute relevant measures - Organise operations |   |  |                       |   |
| Equipment and means  |   |  |                       |   |
| <i>Task/Purpose</i>  | <i>Equipment</i>  | <i>Indicators</i>  | <i>Related equip.</i> | <i>Remarks</i>  |
| Display alarm conditions   |   | Remaining alarm indicators not available at WS for navigation/man. |                       | Include acknowledgement of fire and emergency alarms                            |
| Provide information + other means for safety management                                | Remaining safety controls not available at WS for nav./man.<br>Internal telephone |  |                       | Info about ship's safety systems and contingency plan to be available at the WS |

| <b>Workstation for Radio communication</b>    |   |                   |                       |                |
|---|---|-------------------|-----------------------|----------------|
| Main functions: GMDSS – Public correspondence |   |                   |                       |                |
| Equipment and means                           |   |                   |                       |                |
| <i>Task/Purpose</i>                           | <i>Equipment</i>                            | <i>Indicators</i> | <i>Related equip.</i> | <i>Remarks</i> |
| GMDSS   | To be specified in relation to trading area |                   |                       |                |
| Public correspondence                         |   |                   |                       |                |

| <b>Conning station (pilot)</b>  |                  |   |                       |                                   |
|---|------------------|---|-----------------------|-----------------------------------|
| Main functions: External and internal observations for determination of safe course and speed |                  |   |                       |                                   |
| Equipment and means   |                  |   |                       |                                   |
| <i>Task/Purpose</i>   | <i>Equipment</i> | <i>Indicators</i>   | <i>Related equip.</i> | <i>Remarks</i>                    |
| Observe waters, navigational aids and traffic   | Binoculars       |   |                       | Access to radar                   |
| Observe own ship's heading and steering, speed and propulsion                                 |                  | Gyro repeater<br>Rudder angle<br>Speed<br>RPM/Pitch if relevant |                       |                                   |
| Effect sound signals  | Whistle button   |   |                       |                                   |
| Communicate other ships   | VHF telephone    |   |                       | Easy access from working position |

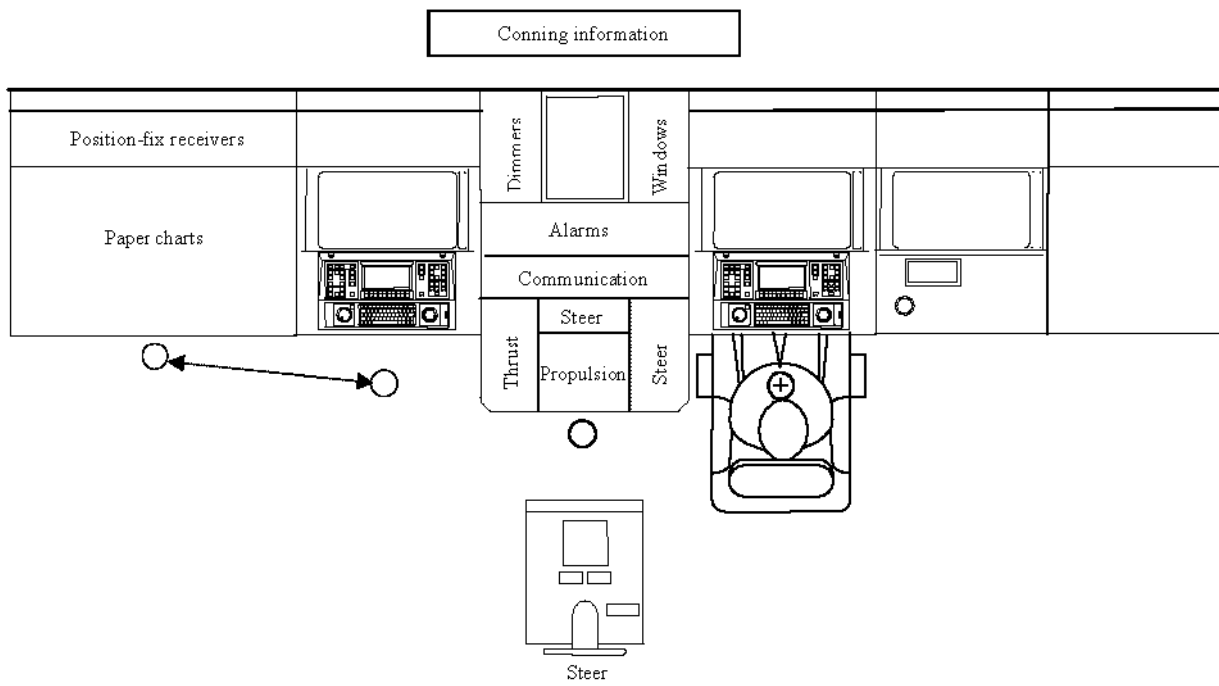

Fig. 3.3.4 Example of principle location of main equipment in a center console, which includes manoeuvring functions



## 4 BRIDGE PROCEDURES

### 4.1 BRIDGE TEAM MANAGEMENT

**4.1.1** Navigating bridges complying with this standard have been designed and arranged with the aim of:

facilitating the tasks to be performed by the bridge team and the pilot in making full appraisal of the situation and in navigating the ship safely under all operational conditions;

promoting effective and safe bridge resource management.

**4.1.2** Procedures shall be established enabling safe operations under all operational conditions by the manning required to master situations that may appear. Such procedures shall be defined in the company and ship specific bridge procedures manual and shall take account of the requirements of the ISM and STCW Codes and include manning requirements, responsibilities and training requirements for all normal and abnormal modes of operation.

**Guidance note.**

The bridge workstations are arranged to suit the distribution of functions and tasks at different

operating conditions by manning the relevant workstations when required, as indicated in the table.

The workplace for traffic surveillance and maneuvering together with the workstation for safety operations and communication form an operational and emergency control centre wherefrom two persons can control the ship and handle emergency events in close cooperation.

### 4.2 OTHER BRIDGE PROCEDURES

**4.2.1** The following routines shall be included and emphasized in the regular bridge procedures:

- use of heading and/or track control systems;
- testing of manual steering system after prolonged use of automatic steering system;
- operation of steering gear;
- updating of nautical charts and nautical publications;
- recording of navigational activities.

Table 4.1.2

| Examples of workstations in use during different operational conditions  |                              |                     |                          |                          |                          |
|--|------------------------------|---------------------|--------------------------|--------------------------|--------------------------|
| Operational conditions   | Waters                       |                     |                          |                          |                          |
|  | Ocean areas<br>Coastal water | Narrow waters       | Pilot waters             |                          | Harbours                 |
|  |                              |                     | General                  | Confined                 |                          |
| Normal   | W1                           | W1 + W2             | W1 + W2*                 | W1 + (W3) + W8           | W1 + W3 + W4             |
| Irregular  | W1 + W2                      | W1 + W2 + W3        | W1 + W2* + W3            | W1 + W2 + W3 + W8        | W1 + W2 + W3             |
| Abnormal   | W1 + W2 + W3                 | W1 + W2 + W3 + W8   | W1 + W2 + W3 + W8        | W1 + W2 + W3 + W8        | W1 + W2 + W3 + W4        |
| Emergency  | W1 + (W3) + W6 + W7          | W1 + (W3) + W6 + W7 | W1 + (W3) + W8 + W6 + W7 | W1 + (W3) + W8 + W6 + W7 | W1 + (W3) + W4 + W6 + W7 |
| *When used by the pilot<br>Symbols:<br>WS = workstation<br>W1 : WS for navigating, manoeuvring (+ traffic surveillance)<br>W2 : WS for monitoring/conning<br>W3 : WS for manual steering<br>W4 : WS for docking<br>W5 : WS for planning<br>W6 : WS for safety operations<br>W7 : WS for communication<br>W8 : conning station. |                              |                     |                          |                          |                          |

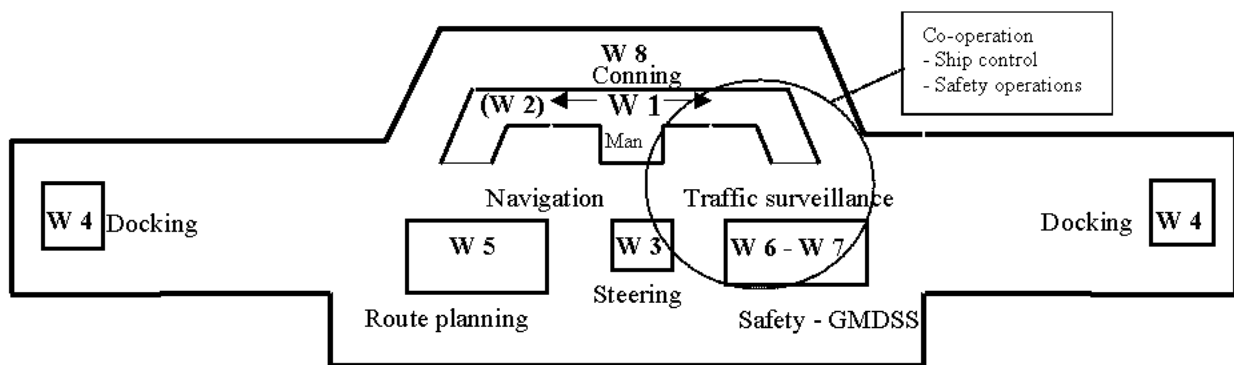

Fig. 4.1.2 Design principles — Location of workstations  
Enabling efficient bridge team management during different operating conditions

## ANNEX 1

### ANALYSIS AND DETAILS OF THE AIMS OF BRIDGE DESIGN AND EQUIPMENT ARRANGEMENT

#### INTRODUCTION

The present Annex contains the details and analysis of aims of the bridge design and equipment arrangement with respect to SOLAS regulation V/15 and its interface with other documents and applicable SOLAS regulations V/19, V/22, V/24, V/25, V/27, V/28), which ensures the achievement of a common understanding of the requirements and approach to their realization.

#### AIM 15.1

Facilitating the tasks (.1) to be performed by the bridge team and the pilot (.2) in making full appraisal of the situation and in navigating the ship safely under all operational conditions (.3).

#### .1 Overall tasks to be performed:

- route planning;
- navigation;
- traffic surveillance;
- maneuvering;
- docking;
- manual steering;
- conning;
- safety operations;
- internal and external communication related to the tasks to be performed;
- pilotage.

.2 Basic tasks performed by the bridge team (based on minimum equipment carriage requirements and regular manning):

- watch officer:
- navigation — position-fixing by:
  - optical system;
  - radar system;
  - reading from display;

- plotting ship's position;
- visual observations;
- adjust ship's heading to follow route;
- traffic surveillance;
- visual look-out;
- monitor radar/ARPA;
- maneuvering;
- adjust ship's heading and speed in relation to traffic;
- external and internal communication related to safety in bridge operation;
- rating, assisting the watch officer:
  - visual look-out;
  - navigator, assisting the watch officer (or watch officer assisting the captain):
    - navigation — route monitoring;
    - position-fixing;
    - plotting ship's position;
    - adjust course;
    - monitor the waters;
    - rating, relieving the automatic heading control:
      - manual steering;
      - pilot assisting in safe navigation:
        - conning and determination of heading and speed.
- .3 Operational conditions and situations:
  - normal condition:
    - when all shipboard systems and equipment related to primary bridge functions operate within design limits, and weather conditions or traffic do not cause excessive operator workloads;
    - irregular condition:
      - when external conditions cause excessive operator workloads requiring professional assistance on the bridge;

abnormal condition:

when internal technical system failures require operation of basic back-up systems or when they occur during an irregular operating condition, or when the officer of the watch becomes unfit to perform his duties and has not yet been replaced by another qualified officer;

emergency situation:

when failure of internal ship systems not affecting the ability of navigation or maneuvering, or fire incidents occur, which need to be controlled and managed from the bridge;

distress situations:

when the ship has lost its navigating or maneuvering capability.

**.3.1** Example of bridge team composition under different operational conditions.

Reference, which may be used for design purposes\*:

normal: watch officer — night: + rating;

irregular: watch officer + assisting navigator (+ rating);

abnormal: captain + watch officer + look-out (+ helmsman);

emergency: captain + watch officer + assisting navigator + look-out (+ helmsman) (+ chief engineer/chief officer).

\*A pilot may be included in any of the above manning examples.

#### **AIM 15.2**

Promoting effective and safe bridge resource management (.1).

**.1** Factors promoting safe resource management: organized distribution of tasks and responsibilities; functional workplace arrangement suiting different operating conditions, task;

distribution and task performance;

procedures for safe operations.

#### **AIM 15.3**

Enabling the bridge team and the pilot to have convenient and continuous access to essential information (.1), which is presented in a clear and unambiguous manner, using standardized symbols and coding systems for controls and displays (.2).

**.1** Essential information (and controls) required by the bridge team.

The information and controls required as well as what is to be regarded essential are linked to the type and importance of tasks to be carried out by the individual members of the bridge team and the pilot.

The table showing task and means, which is included in 2.1, identifies the essential information required. Easy access to information may be provided by outfitting and placing the workstations for efficient task performance by members of the bridge team, in accordance with the content of 3.3.

**.2** Presentation of information and standardization.

Requirements addressing presentation of information and coding of systems for controls and displays for equipment required to be carried are regulated by IMO performance standards and IEC test standards.

#### **AIM 15.4**

Indicating the operational status (.4) of automated functions (.1) and integrated components (.2), systems and/or sub-systems (.3).

**.1** Relevant automated functions:

steering a set course;

plotting ship's position in an electronic chart system;

steering along a planned route governed by ship's position;

adjusting the speed according to ship's position and preset values;

maneuvering operations (semi-automatic/joystick).

**.2** Relevant integrated components:

heading control unit;

satellite positioning-fixing unit (GNSS and GPS);

electronic chart display unit (ECDIS);

radar display unit;

track control unit;

speed control unit.

**.3** Relevant systems:

track control system;

integrated navigation systems (INS), including grounding avoidance system for automatic route-keeping.

**.4** Indicating the operational status (of automated functions and integrated components, systems and/or sub-systems).

Indication of operational status is provided by:

supplying continuous information of relevant system activities related to the ship's course, speed, propulsion, steering and operating mode on one individual display;

enabling continuous visual observation of key values;

enabling the checking of the functioning of system elements and operational performance;

enabling early detection of deviations from planned operations and system specifications.

Categories of indications that may be included:

normal operations:

available components in the total system configuration;

configuration in use;

activity status of individual components in use;

second mode of operation at system failure, preferably based on system failure;

mode, effect and criticality analysis (FMEAC);

early warning;  
 reduced accuracy;  
 reduced reliability of integrated system performance;  
 reduced reliability of propulsion and steering system;  
 alarm conditions:  
 equipment malfunction;  
 system failure;  
 display freeze;  
 operational warnings:  
 danger of collision;  
 danger of grounding;  
 weather conditions.

#### **AIM 15.5**

Allowing for expeditious, continuous and effective information processing and decision-making (.1) by the bridge team and the pilot.

**.1** Conditions allowing effective information processing and decision-making:

when all information required for evaluation and decision-making is clearly presented and available at the location where action shall be taken on the decision made, including appropriate feedback on actions and updated information for continuous consideration;

when information and equipment for performance of functions to be carried out by different members of the bridge team are arranged at specific workstations located for close co-operation.

#### **AIM 15.6**

Preventing or minimizing excessive or unnecessary work and any conditions or distractions on the bridge, which may cause fatigue or interfere with the vigilance of the bridge team and the pilot (.1).

**.1** Conditions that may interfere with the vigilance of the bridge team.

Such conditions include:

poor working environment;  
 location of workstations for additional functions too close to navigation area;  
 location of information needed for decision-making, which is wide spread;  
 lack of harmonization of workplace functionality;  
 unauthorized persons on the navigating bridge;  
 high workloads.

#### **AIM 15.7**

Minimizing the risk of human error and detecting such error if it occurs (.1), through monitoring and alarm systems (.2), in time for the bridge team and the pilot to take appropriate action (.3).

**.1** Factors imperative for minimizing human error.

Workplace related:

workplace functionality;  
 information availability;  
 system reliability;  
 human-machine interface;  
 system architecture of automation systems based on fail-to-safe philosophy with simple and reliable second mode of operations.

Human related:

competence;  
 attitude;  
 complacency.

Operational:

manning;  
 working routines;  
 bridge team management.

Detectable during operations:

inappropriate performance.

**.2** Monitoring and alarm systems.

Systems and methods enabling detection of human error and timely warning for appropriate action include:

monitoring and alarm transfer systems, monitoring personal activity and lack of response on operational warnings and alarm conditions related to safety of navigation and the ship's safety systems, and transferring unacknowledged warnings and alarms to qualified person.

**.3** In time for appropriate action.

Conditions affecting the time for appropriate action:

Operational warnings:  
 time to danger of collision and grounding (distance/speed);  
 time to be allowed for required action.  
 Equipment and system failure alarms:  
 failure mode and effect;  
 size of navigating area.

## ANNEX 2

## EXAMPLES OF ARRANGEMENT OF BRIDGE MAIN EQUIPMENT

Table of tasks and related means for safe operations

| Tasks and Means - Location  |   |                         |   |                                    |  |
|---|---|-------------------------|---|------------------------------------|--|
| Function/Tasks to be performed  | Equipment to be operated  | L                       | Information to be viewed  | L                                  | Remarks  |
| <i>Navigation</i><br>– <i>Grounding avoidance</i>   |   |                         |   |                                    | L = Reference for location in console  |
| Planning  |   |                         |   |                                    |  |
| Plan route prior to departure   | Paper chart/table   | N1                      |   |                                    |  |
| Alter route while under way   | Nautical publications   | N2                      | GPS Position  |                                    |  |
|   | ECDIS*  | N3                      |   |                                    | *Optional install.   |
|   | ECDIS backup**  | N4                      |   |                                    | **If replacing paper   |
| In Transit  |   |                         |   |                                    |  |
| Monitor route-keeping:<br>- Determine position by bearings<br>- Read position on display<br>- Plot position | Pelorus/gyro repeater*<br>Radar<br>DGPS<br>Paper chart/table                                  | N5<br>N6<br>N2<br>N1    |   |                                    | *Analog.<br>Bearings 360° around the horizon, (one on each bridge wing)                      |
| - Determine and plot position automatic   | ECDIS   | N3                      |   |                                    | Optional installation  |
| Maintain route/alter course by<br>- manual steering<br>- using autopilot<br>- automatic route-keeping       | Manual steering ctrl<br>Heading ctrl. system<br>Track ctrl. system*<br>(ECDIS)                | M1<br>M2<br>M2A*<br>NA2 |   |                                    | *Alternative to head ctrl.<br>Interfaced to ECDIS, gyro, speed, radar when part of INS       |
| Give sound signals  | Whistle ctrl.   | C1                      |   |                                    | Fog - traffic  |
| Receive sound signals   | Sound reception syst.   | C2                      | Loudspeakers  |                                    | Enclosed bridge  |
| Monitor/Take action:<br>- operational warnings<br>- system failure alarms                                   | Alarm panel   | S1                      |   |                                    |  |
| - ship's safety state   | Alarm systems   | S2                      |   |                                    |  |
| Monitor heading, turn, rudder angle, speed, propulsion  |   |                         | Gyro repeater<br>Indicators:<br>- rudder angle<br>- rate-of-turn<br>- RPM, Pitch<br>- speed log | IM1<br><br>IM2<br>IM3<br>IM4<br>M5 |  |
| Adjust lighting   | Dimmer buttons  | L1                      |   |                                    |  |
| Monitor shallow water areas   | Echo Sounder system   | N10                     | Water depth   | IN1                                | (Anchoring)  |
| Monitor performance automatic route-keeping system  |   |                         | Conning info display  | IA3                                | Organizing indicator info providing situation awareness when in automatic route-keeping mode |
| Effect internal communication   | Intercom (auto tlph.)   | C3                      |   |                                    |  |
| Effect external comm.   | VHF   | C4                      |   |                                    | Related to nav.  |
| Receive/send distress message   | GMDSS remote ctrl.  | C5                      |   |                                    |  |
| <i>Traffic surveillance</i><br>– <i>Collision avoidance</i>   |   | T                       |   |                                    |  |
| Detect floating targets<br>Analyse traffic situations<br>Observe visually                                   | Radar with<br>ETP* (may incl. AIS)<br>Binoculars<br>Window wiper -cleaning -<br>heating ctrl. | T1                      | Targets relative position,<br>course, speed<br>Expected passing distance<br>Time                |                                    | *Electronic target plotting ("historical" data)  |
| Decide on collision avoidance measures  | AIS (automatic identification system)   | T2                      | Target true position, course, speed   |                                    | Regarded additional info (means)   |
| Manoeuvring   |   | M                       |   |                                    | (For route-keeping)  |

|  |   |                |                                      |                   |   |
|--|---|----------------|--------------------------------------|-------------------|---|
| Change steering mode   | Steering mode switch  | M0             |                                      |                   |   |
| Alter heading  | Heading ctrl.   | M2             | Heading (Gyro)                       | IM1               |   |
| Observe rudder angle   |   |                | Rudder angle                         | IM2               |   |
| Override steering  | Override ctrl.  | M4             |                                      |                   |   |
| Manual steering ctrl.  |   | M1             |                                      |                   |   |
| Change speed   | Propulsion ctrl.  | M3             | RPM/Pitch                            | IM4               |   |
| Give sound signals   | Whistle ctrl.   | C1             |                                      |                   |   |
| Receive sound signals  | Sound reception syst.                                       | C5             | Loudspeaker                          | IC5               | Enclosed bridges  |
| Navigate back to route   | Paper chart/table<br>DGPS                                   | N1<br>N2       |                                      |                   |   |
| Maintain track of traffic  | Radar with route and<br>navigable waters                    | T1             |                                      |                   |   |
|  | ECDIS*  | N3             |                                      |                   | *May replace paper  |
| Harbour manoeuvring  | Thruster  | M5             |                                      |                   | Owners specification  |
| Anchoring  |   |                |                                      |                   |   |
| Manoeuvre  | Manual steering ctr.<br>Propulsion ctr.<br>(Thruster ctrl.) | M1<br>M3<br>M5 | Heading<br>Rudder angle<br>RPM/Pitch | IM1<br>IM2<br>IM4 | Performed at front<br>workstations or in<br>combination with<br>docking station.<br>Information to be<br>provided for Pilots. |
| Positioning<br>(Identify anchor position)  | Radar<br>Chart<br>DGPS                                      | T1<br>N1<br>N2 | Water depth                          | IM6               |   |
| Observe ship's safety state  |   |                |                                      |                   |   |
| Monitor alarm conditions:<br>- Navigation alarms<br>Equip. & system failures<br>Operational warnings | Main alarm panel<br>W/indicators and<br>acceptance button   |                | Alarm list                           |                   |   |
| - Machinery alarms   | Alarm panel   |                |                                      |                   |   |
| - Cargo alarms   | Alarm panel   |                |                                      |                   |   |
| - Fire alarm   | Fire alarm panel  |                |                                      |                   |   |

|   |                      |  |                         |     |                       |
|---|----------------------|--|-------------------------|-----|-----------------------|
| <i>Conning station</i>  |                      |  |                         |     |                       |
| Determine & direct course and<br>speed in relation to waters and<br>traffic |                      |  |                         |     |                       |
| Monitor:  |                      |  |                         |     |                       |
| - heading   |                      |  | Gyro repeater           | IM1 | Digital, readable 2 m |
| - rudder angle  |                      |  | Rudder angle            | IM2 |                       |
| - rate-of-turn  |                      |  | RoT indicator           | IM3 |                       |
| - propulsion  |                      |  | RPM/Pitch               | IM4 |                       |
| - speed   |                      |  | Speed log               | IM5 |                       |
| - water depth   |                      |  | Echo sounder<br>display | IM6 | Anchoring             |
| Give sound signals  | Whistle ctrl. button |  |                         |     |                       |
| Effect communication  | VHF                  |  |                         |     | Available             |
|   |                      |  |                         |     |                       |
|   |                      |  |                         |     |                       |

|   |                                      |          |  |  |          |
|---|--------------------------------------|----------|--|--|----------|
| <i>Manual steering</i>                                |                                      |          |  |  |          |
| Maintain, adjust, alter heading<br>according to order | Steering ctrl.<br>Intercom (Command) | M6<br>C6 | Gyro repeater<br>Magn. comp.<br>Rudder angle<br>Rate-of-turn |  | (Rating) |

|  |                                  |  |                        |  |  |
|--|----------------------------------|--|------------------------|--|--|
| <i>Safety operations</i>   |                                  |  |                        |  |  |
| Take action on alarm condition:<br>- analyse situation<br>- consult plans and drawings | Manuals - Drawings               |  | Computer based<br>info |  |  |
| - observe ship's external<br>operational situation                                     |                                  |  |                        |  | Cooperation with<br>navigating officer |
| - organize and execute<br>measures by communication<br>- check status of ventilation   | Intercom (UHF)<br>Emergency stop |  |                        |  |  |

|   |                                |  |  |  |  |
|---|--------------------------------|--|--|--|--|
| system                                  |                                |  |  |  |  |
| Monitor development of alarm conditions |                                |  |  |  |  |
| - Cargo alarms                          | Alarm panel                    |  |  |  |  |
| - Fire detection & alarms               | Fire detection and alarm panel |  |  |  |  |
| - Gas & smoke detection                 |                                |  |  |  |  |

|  |                      |    |  |  |                     |
|--|----------------------|----|--|--|---------------------|
| <i>External communication</i>                          |                      |    |  |  |                     |
| Distress - weather - safety                            | GMDSS station        | C7 |  |  | As required (Area)  |
| Determine weather conditions<br>Consider nav. warnings | Navtex receiver      | C8 |  |  |                     |
| Public correspondence                                  | Additional equipment |    |  |  | Specified by owners |

|  |   |                |                         |            |                               |
|--|---|----------------|-------------------------|------------|-------------------------------|
| <i>Docking operations<br/>(bridge wings)</i> |   |                |                         |            |                               |
| Directing steering                           | Intercom (command)                        | C6             | Heading<br>Rudder angle | IM1<br>IM3 |                               |
| Directing speed                              | Intercom (command)                        | C6             | RPM/Pitch               | IM5        |                               |
| Giving sound signals                         | Whistle control button                    | C1             |                         |            |                               |
| Receiving sound signals                      | Sound reception syst.                     | C2             | Loudspeaker             | IC2        | Enclosed bridge               |
| Perform manoeuvring                          | Steering<br>Prop. ctrls<br>Thruster ctrl. | M1<br>M3<br>M4 |                         |            | Additional install. by owners |
| <i>Additional functions</i>                  |   |                |                         |            | See 2.2                       |

Symbols used in column "L" of the Table:  
 N = equipment for navigation;  
 A = indicating extended automation of function;  
 I = information — indicators/displays for navigation;  
 T = equipment for traffic surveillance;  
 C = communication means;  
 M = means required for manoeuvring functions.

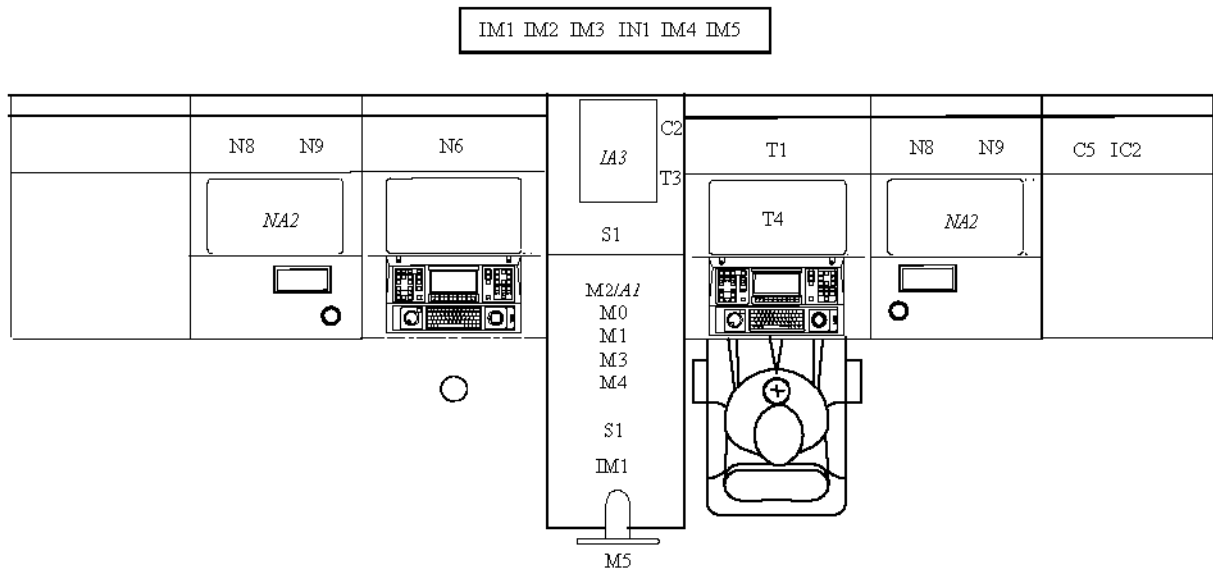

Individual workplaces

Example of location of main equipment in a centre console.  
 Easy access to maneuvering functions in standing position (refer to 3.3.3)

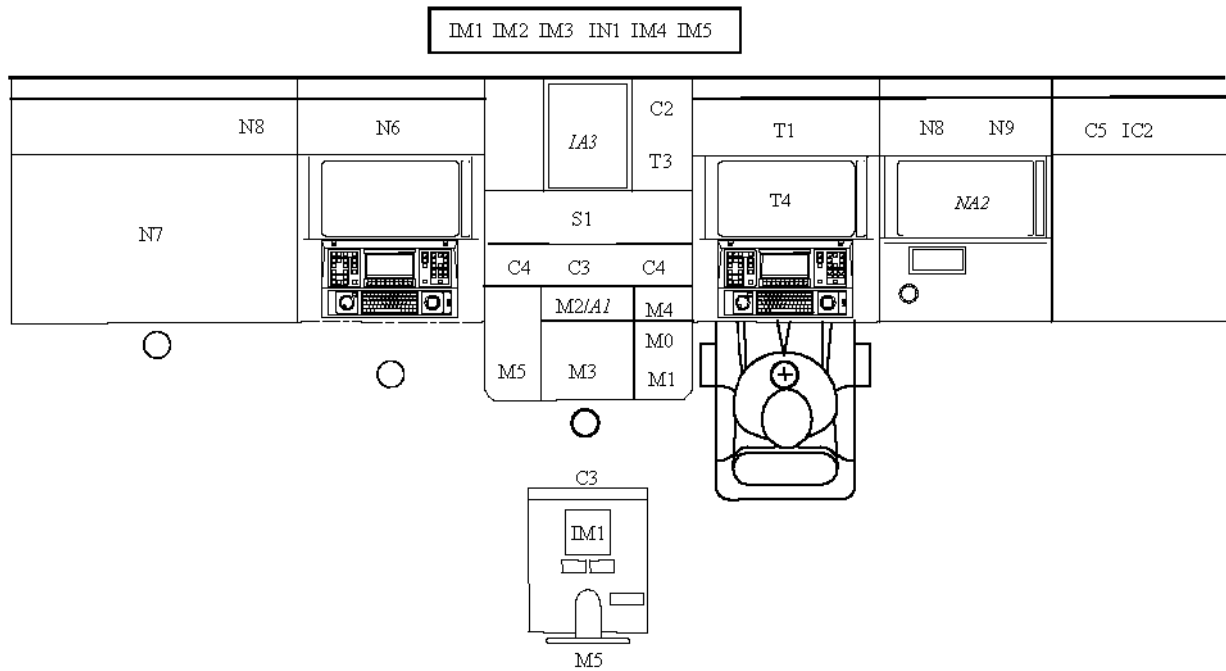

Redundant workstations

When all the means required for performance of navigation, traffic surveillance and maneuvering are available at each of the two workplaces, a long centre console dividing the workstation may be used



**RULES  
FOR THE CARGO HANDLING GEAR  
OF SEA-GOING SHIPS**

# 1 GENERAL

## 1.1 APPLICATION

**1.1.1** The requirements of these Rules apply to cargo handling gear to be installed on sea-going ships and floating facilities and intended for loading, unloading and moving of loads from one position to another and for conveyance of persons, and other cargo handling gear listed in 1.3.1.

The Rules requirements apply also to loose gear suspended to cargo gripping devices which are an integral part of the ship, such as slings, lifting beams, frames and container spreaders, etc.

**1.1.2** The Rules requirements are not applicable to the suspended drilling equipment and cargo handling gear used for production processes in MODU, drilling and geological exploration ships, pipe layers, etc. as well as to grabs and cargo lifting electromagnets.

**1.1.3** These Rules apply in full measure to cargo handling gear, technical documentation for which was submitted to the Register for consideration after coming into force of these Rules.

The existing cargo handling gear are covered by the requirements of the Rules according to which they have been manufactured, as well as the requirements of Sections 10 to 12 of these Rules. Application of the present Rules in repair and re-rigging of the existing cargo handling gear and in replacement of their interchangeable components and loose gear is subject to special consideration of the Register in each case.

**1.1.4** Cargo handling gear which are not regulated by the present Rules or those designed to operate under special conditions not specified in these Rules are subject to special consideration of the Register.

**1.1.5** Compliance with the requirements of these Rules is mandatory for obtaining or maintaining Register documents on cargo handling gear. Such documents are not part of the classification documents.

**1.1.6** The Register may impose additional requirements not incorporated in these Rules provided they are necessary to ensure safe operation of the equipment.

**1.1.7** Provisions of the International Convention on Occupational Safety and Health (Deck Work), 1979 (ILO-152) have been taken into account in the relevant Sections of the Rules.

## 1.2 DEFINITIONS AND EXPLANATIONS

**1.2.1** For the purpose of these Rules the following definitions and explanations have been adopted.

Shoes of the ship elevating platform are elements of movable parts of the ship elevating platform which ensure a certain position of the platform in relation to the guides.

Buffer of ship elevating platform is a damping stop which provides substantial energy absorption of movable mass of the ship elevating platform.

Upper structure of floating crane, crane ship, etc. is a cargo handling erection installed on the open deck which is designed to support a cargo handling gear and loads.

Jib radius of boom is the maximum distance between the centre of gravity of the cargo hoisted and the vertical axis of derrick heel swivel rotation.

Cargo derrick reels mean machinery used for moving derrick booms without a load or holding them securely when the boom is loaded, and driven either by winches or independently.

Ship cargo lift is a ship lift intended for lifting and lowering loads not accompanied by people.

Cargo handling gear is a combination of appliances installed on board ship (floating facility) and intended for loading, unloading and moving of loads from one position to another and for conveyance of persons (ship derricks, ship cranes, hoists, ship lifts, ship elevating platforms and upper structures of floating cranes and crane ships).

Lifting capacity is the maximum weight of a safely lifted load including that of auxiliaries used for securing the load, such as slings, lifting beams, platforms, nets, etc., as well as the weight of grabs, cargo lifting electromagnets, boxes and buckets.

Safe working load of ship lift is the maximum permissible weight of persons or loads, for lifting or lowering of which the lift is designed, including the weight of auxiliary loose gear temporarily used for securing the loads.

Gear includes items of cargo handling appliance used for transmission of forces and effecting of kinematic connection, other than machinery parts.

Safe working load (SWL) is the maximum allowable static load applied to each individual component of the cargo handling gear.

Safe working load (SWL) for multiple-sheaved blocks is the working load limit on the eye.

Safe working load (SWL) for single-sheaved blocks with or without a becket is the maximum allowable rope pull. For single-sheaved blocks without a becket the allowable rope pull is equal to half

the working load limit on the block eye. For single-sheaved blocks with a becket the allowable rope pull is equal to one-third of the working load limit on the block eye.

Annual inspection is conducted to verify the compliance of the cargo handling gear with documents issued. The scope of the annual survey is specified by the Surveyor depending on the technical condition of the cargo handling gear.

Interchangeable components are such items as chains, rings, hooks, shackles, blocks, turn-buckles, etc. which are parts of a cargo handling gear or loose gear attached to the elements of the cargo handling gear or loose gear by detachable connections.

Ship lift car is a load-carrying part of the ship lift enclosed over its entire height and provided with a floor and ceiling.

Competent person means a Surveyor to the Register or a responsible person authorized or recognized by the Register.

A responsible person authorized or recognized by the Register may be:

a responsible representative of the manufacturer recognized by the Register as a competent person regarding testing of loose gear and interchangeable components with a proof load, testing of wire and natural fibre ropes and chains as well as heat treatment of components in case where is no Surveyor to the Register or where the manufacturer has a permit for carrying out such tests and works without survey by the Register;

a non-exclusive Surveyor to the Register authorized to carry out survey according to the Agreement between the Register and the non-exclusive Surveyor.

Competent body means ministry, governmental institution or some other administration authorized to issue rules, decrees or other instructions having the force of the law.

Limit switch is a device automatically limiting movement of a cargo handling gear or part thereof by disconnecting the machinery drive in the extreme positions.

Safety factor is the ratio of the minimum breaking load to the safe working load.

Winch with a drum is a winch having a drum to coil a rope thereupon.

Winch with attraction sheave is a winch provided with a sheave which produces a pull in the rope by means of its traction in the groove of special design.

Winches are machines for hoisting, lowering and movement of cargo or booms.

Light-lift derrick is a ship derrick with a safe working load of less than 10 tons per single-slewed derrick.

Lift gripping devices are automatically operated devices for braking the lift car or a counterweight with a certain deceleration and holding them in the guides in case a preset speed is exceeded when moving downwards or in case of a break in the rope.

Metal structures (load-bearing-structures) include derricks, masts, posts, bridges, gantries, etc. which take up loads acting on the cargo handling gear.

Derrick crane is a cargo handling gear having a boom which can be raised, lowered and slewed with the help of winches which are an integral part of the cargo handling gear.

Machinery include cargo winches, cargo derrick reels, machinery used for topping, slewing and hoisting crane booms and travel of cranes and hoists.

Guides of ship elevating platform are part of the ship elevating platform designed to ensure the required direction of the platform movement and to hold the platform in the position when gripping devices are tripped.

Fixed gear includes items permanently attached to the structural elements of the cargo handling gear or to the ship hull, such as derrick eye plates or guy ropes on booms, span eye plates and heel goosenecks with their bearings, derrick heel fork lugs, mast and derrick bands, deck eye plates, built-in sheaves, etc.

Automatic overload cut-out is a device automatically limiting a load on the crane or part thereof by disconnecting the machinery drive when the load exceeds safe working load.

Lift overspeed governor is a device by which gripping devices are tripped when the preset speed is exceeded.

Ship passenger lift is a ship lift intended for lifting and lowering persons or loads accompanied by people.

Floating facility is a structure, such as a pontoon, floating dock, repair ship, mobile offshore drilling unit or a similar floating structure.

A platform of a ship elevating platform is a load-carrying structure of the ship elevating platform with or without side guards, which runs between the guides with the help of ropes, a lever-pulling system, hydraulic drives, gear rack or spindle. Where structurally required, a platform can form a decked-in area of the ship and be fixed with locking devices in the working positions during cargo handling operations and in the "stowed for sea" position. The ship elevating platform may have one or two platforms to carry out simultaneous cargo handling operations on different decks.

Hoist is a stationary power-driven or hand-operated lifting appliance of a simplified design of cat davit, telfer, purchase or whip type.

Effective jib radius of boom is the maximum distance from the centre of gravity of the cargo hoisted to the side or transom of pontoon when it is upright.

Thorough examination means external inspection supplemented, where necessary, by other methods of survey, such as hammering, measuring, flaw detection, functional tests and disassembling of the examined structures, machinery and parts of the cargo handling gear to check their condition and to verify their safe operation.

Driving unit is hydraulic pump units and winches.

Principle of acceptable number of passengers is determination of the safe working load based on permissible number of passengers which depends on the usable area of the car floor.

Proof load is a load whose weight is certified with an accuracy of  $\pm 2$  per cent for carrying out proof load tests.

Container spreader is a cargo-gripping device in the form of a frame or a beam with fittings for gripping containers, which comply with international standards and which are mechanically or manually connected to the upper corner fittings of the container.

Ship derrick is a cargo handling gear designed for holding and moving loads by the system of blocks and ropes suspended to the derrick structure and beyond it (to masts, posts, decks and winches).

Ship elevating platform is a cargo handling gear with one or more platforms for vertical transportation of loads between cargo decks of ro-ro ships, operated by hydraulically or electric and mechanical drives.

Ship crane is a cargo handling gear (stationary or mobile) capable of transporting loads without any blocks or ropes suspended outside its structure.

Ship lift is a cargo handling gear intended for lifting and lowering persons or loads in a car running between the guides positioned vertically in the trunk relative to the position of the ship on an even keel, and provided with lockable doors on all passenger or cargo decks.

Loose gear includes slings, lifting beams, frames and container spreaders, etc., by means of which a load can be secured to the cargo handling gear but which do not form an integral part of the cargo handling gear or load.

Heavy - lift derrick is a ship derrick with a safe working load of 10 tons and more per single-sled derrick.

Lifting capacity indicator is a device automatically showing (no matter whether the load is

suspended or not) the maximum allowable design load for the particular crane at different jib radii.

Stop of ship elevating platform is a device which limits platform movement in emergency or in extreme working positions.

Lift trunk is a totally enclosed ship space where the lift car and counterweight are positioned.

The terms used in these Rules are shown in Figs 1 to 5.

### 1.3 SCOPE OF SURVEY

**1.3.1** Subject to survey by the Register are the following cargo handling gear:

**.1** ship derricks, ship cranes and hoists having lifting capacity 1 ton and more;

**.2** upper structures of floating cranes and crane ships;

**.3** cranes on floating docks and cranes mounted on mobile offshore drilling units intended for loading and unloading of MODU supply vessels with safe working load 1 ton and more;

**.4** ship cargo lifts with safe working load 250 kg and more and electrically driven passenger lifts intended for lifting and lowering of persons and/or loads in the car moved by the ropes with a speed not in excess of 1,0 m/s;

**.5** ship elevating platforms with a lifting capacity 1 ton and more which move up and down with a speed not in excess of 0,1 m/s.

Survey of cargo handling gear of other types and purposes shall be specially considered by the Register in each particular case.

**1.3.2** Register survey of cargo handling gear of other types covers:

**.1** consideration and approval of technical documentation;

**.2** survey of manufacture, installation on board ship (floating facility) and repairs of cargo handling gear;

**.3** examinations and tests;

**.4** branding;

**.5** issue of Register documents.

**1.3.3** The following items are subject to survey by the Register:

**.1** ship derricks:

metal structures;

winches and reels;

components and ropes;

**.2** cranes and hoists:

metal structures;

machinery;

components and ropes;

safety devices;

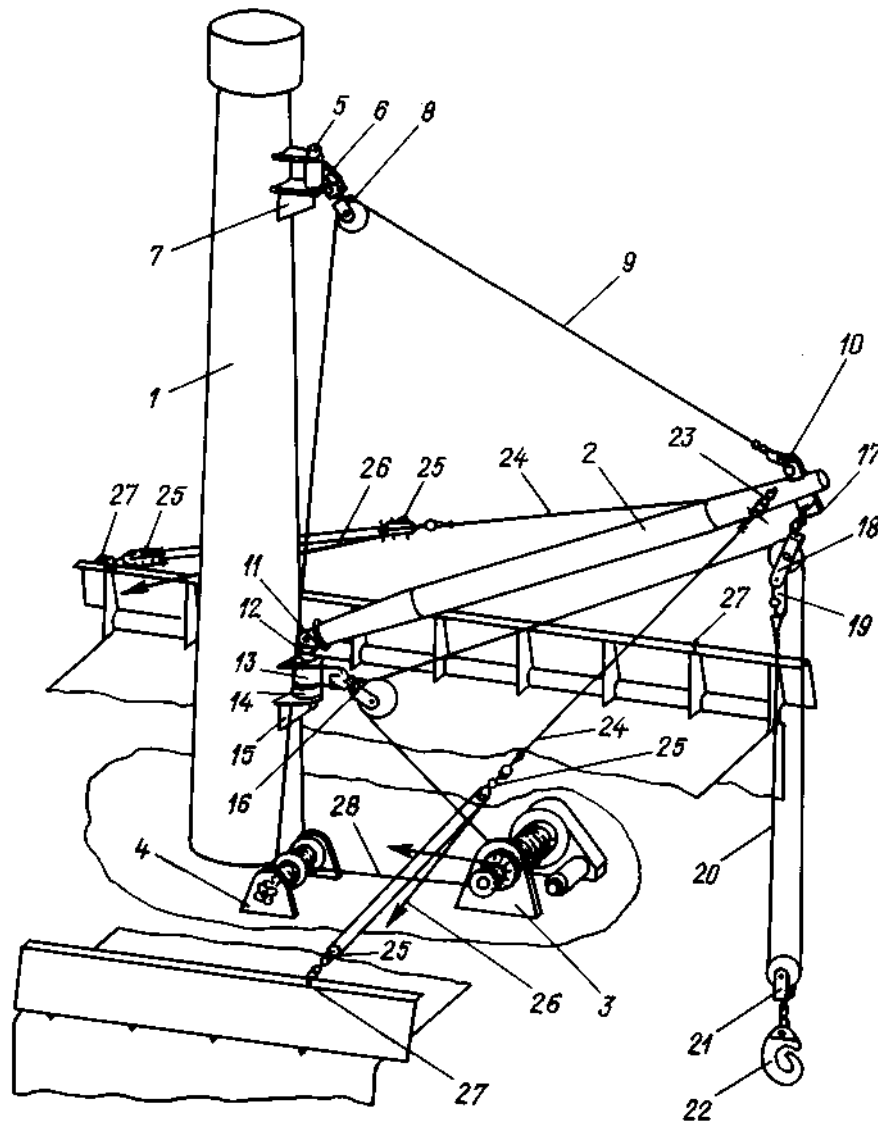

Fig. 1 Typical rigging of light-lift derrick

- |                          |                          |
|--------------------------|--------------------------|
| 1. Cargo mast            | 15. Gooseneck bearing    |
| 2. Derrick               | 16. Lead block           |
| 3. Cargo winch           | 17. Derrick head fitting |
| 4. Span winch            | 18. Upper cargo block    |
| 5. Span swivel bolt      | 19. Becket               |
| 6. Trunnion piece        | 20. Cargo runner         |
| 7. Span bearing          | 21. Lower cargo block    |
| 8. Span block            | 22. Cargo hook           |
| 9. Span rope             | 23. Guy plate            |
| 10. Shackle              | 24. Guy pendant          |
| 11. Derrick heel fitting | 25. Tackle block         |
| 12. Gooseneck            | 26. Guy                  |
| 13. Lead block holder    | 27. Eye plate            |
| 14. Adjusting ring       | 28. Topping rope         |

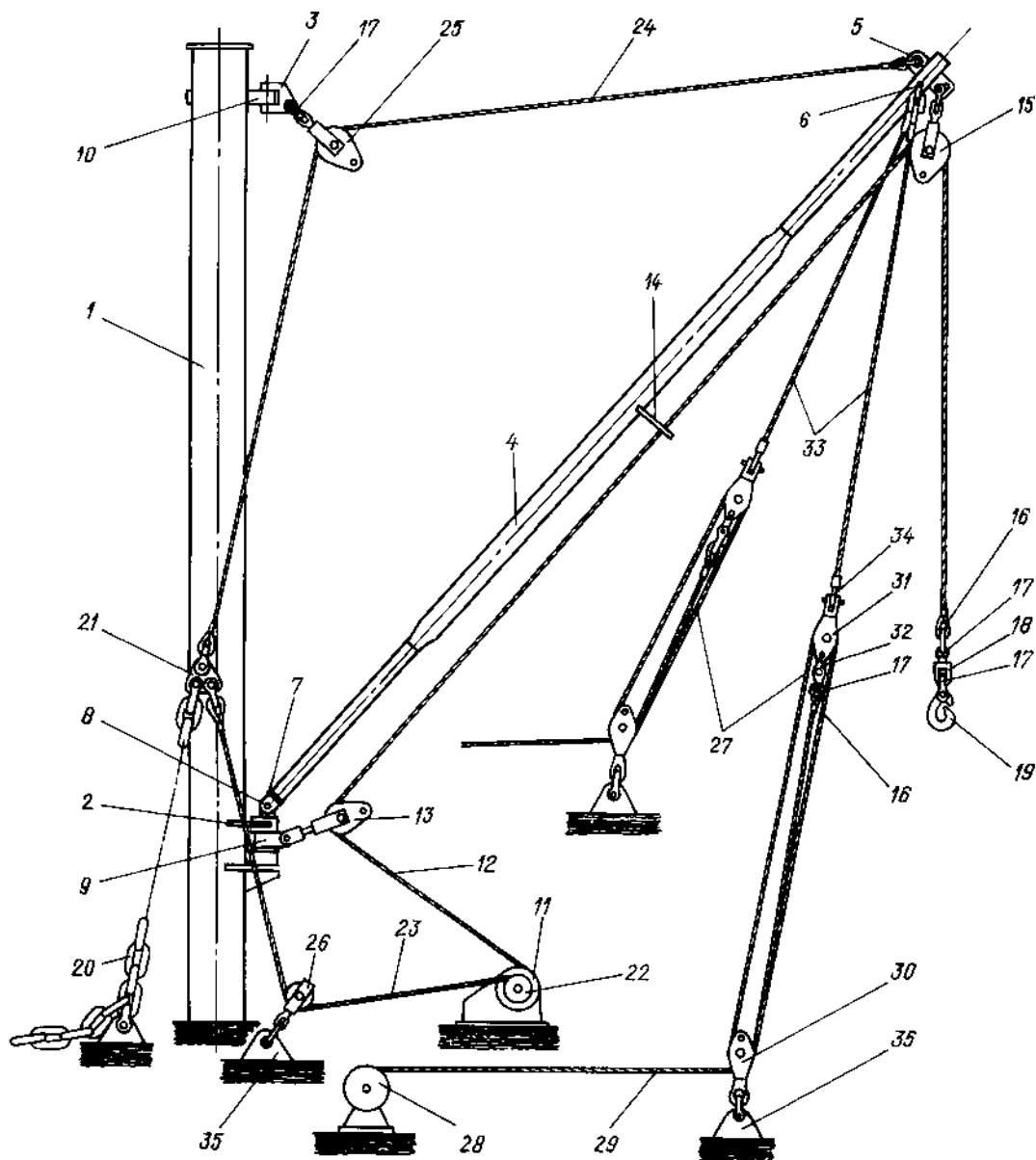

Fig. 2 Alternative rigging of light-lift derrick

- |                                   |                                |
|-----------------------------------|--------------------------------|
| 1. Cargo mast                     | 18. Swivel                     |
| 2. Gooseneck                      | 19. Cargo hook                 |
| 3. Span gooseneck                 | 20. Cargo runner chain stopper |
| 4. Derrick                        | 21. Triangle plate             |
| 5. Derrick head fitting           | 22. Winch drum                 |
| 6. Guy plate                      | 23. Topping rope               |
| 7. Derrick heel fitting           | 24. Span rope                  |
| 8. Swivel axle                    | 25. Span lead block            |
| 9. Cargo runner lead block holder | 26. Snatch block               |
| 10. Trunnion piece                | 27. Guy tackle                 |
| 11. Cargo winch                   | 28. Guy winch                  |
| 12. Cargo runner                  | 29. Running end of guy tackle  |
| 13. Cargo runner lead block       | 30. Lower guy block            |
| 14. Cargo runner guide            | 31. Upper guy block            |
| 15. Cargo block                   | 32. Eye                        |
| 16. Thimble                       | 33. Guy pendant                |
| 17. Shackle                       | 34. Thimble                    |
|                                   | 35. Eye plate with round lug   |

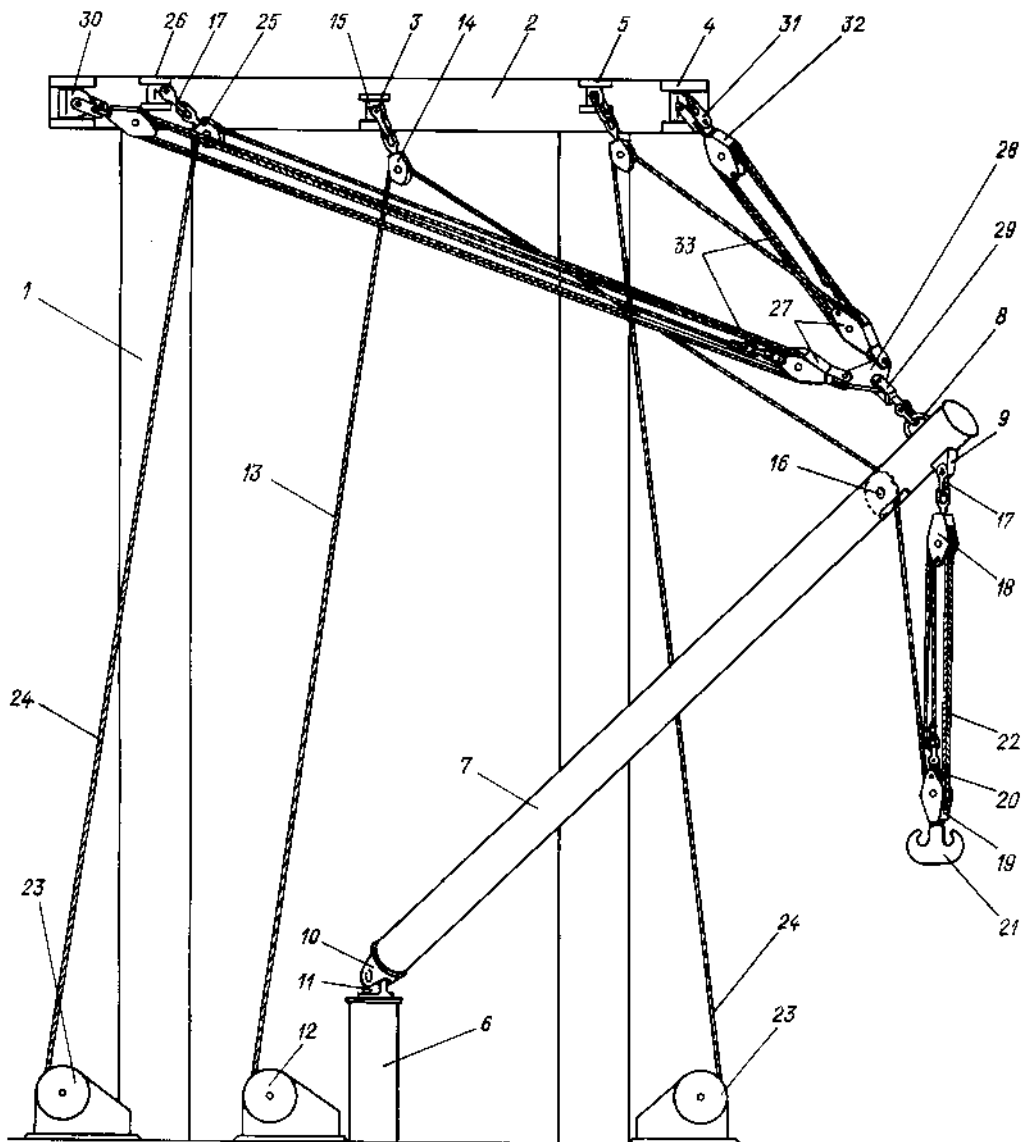

Fig. 3 Typical rigging of twin span tackle heavy-lift derrick

- |                             |                               |
|-----------------------------|-------------------------------|
| 1. Gantry                   | 18. Lower tackle cargo block  |
| 2. Cross-tree               | 19. Upper tackle cargo block  |
| 3. Cargo runner gooseneck   | 20. Eye                       |
| 4. Span gooseneck           | 21. Cargo hook                |
| 5. Lead block gooseneck     | 22. Cargo tackle              |
| 6. Gooseneck bearing        | 23. Topping winch             |
| 7. Derrick heel fitting     | 24. Span rope                 |
| 8. Trunnion piece           | 25. Span lead block           |
| 9. Cargo runner plate       | 26. Span lead block plate     |
| 10. Derrick heel fitting    | 27. Span tackle movable block |
| 11. Gooseneck               | 28. Triangle plate            |
| 12. Cargo winch             | 29. Gooseneck                 |
| 13. Cargo runner            | 30. Span tackle block plate   |
| 14. Cargo runner lead block | 31. Double fitting            |
| 15. Cargo runner plate      | 32. Span tackle fixed block   |
| 16. Built-in sheave         | 33. Span tackle               |
| 17. Shackle                 |                               |

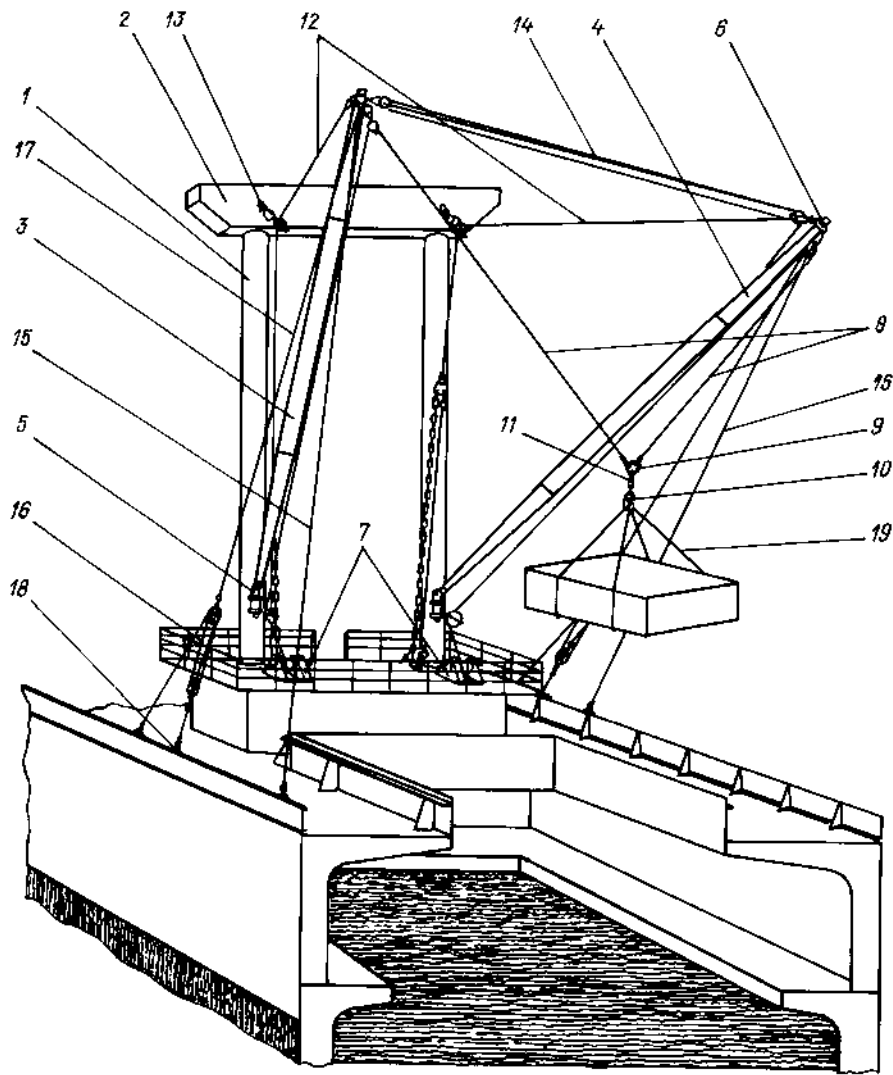

Fig. 4 Typical rigging for union purchase

- |                         |                    |
|-------------------------|--------------------|
| 1. Gantry               | 11. Gooseneck      |
| 2. Cross-tree           | 12. Span rope      |
| 3. Hatch derrick        | 13. Trunnion piece |
| 4. Yard-arm derrick     | 14. Span tackle    |
| 5. Derrick heel fitting | 15. Preventer guy  |
| 6. Boom iron            | 16. Guy tackle     |
| 7. Cargo winches        | 17. Guy pendant    |
| 8. Cargo runner         | 18. Guy plate      |
| 9. Triangle plate       | 19. Sling          |
| 10. Cargo hook          |                    |



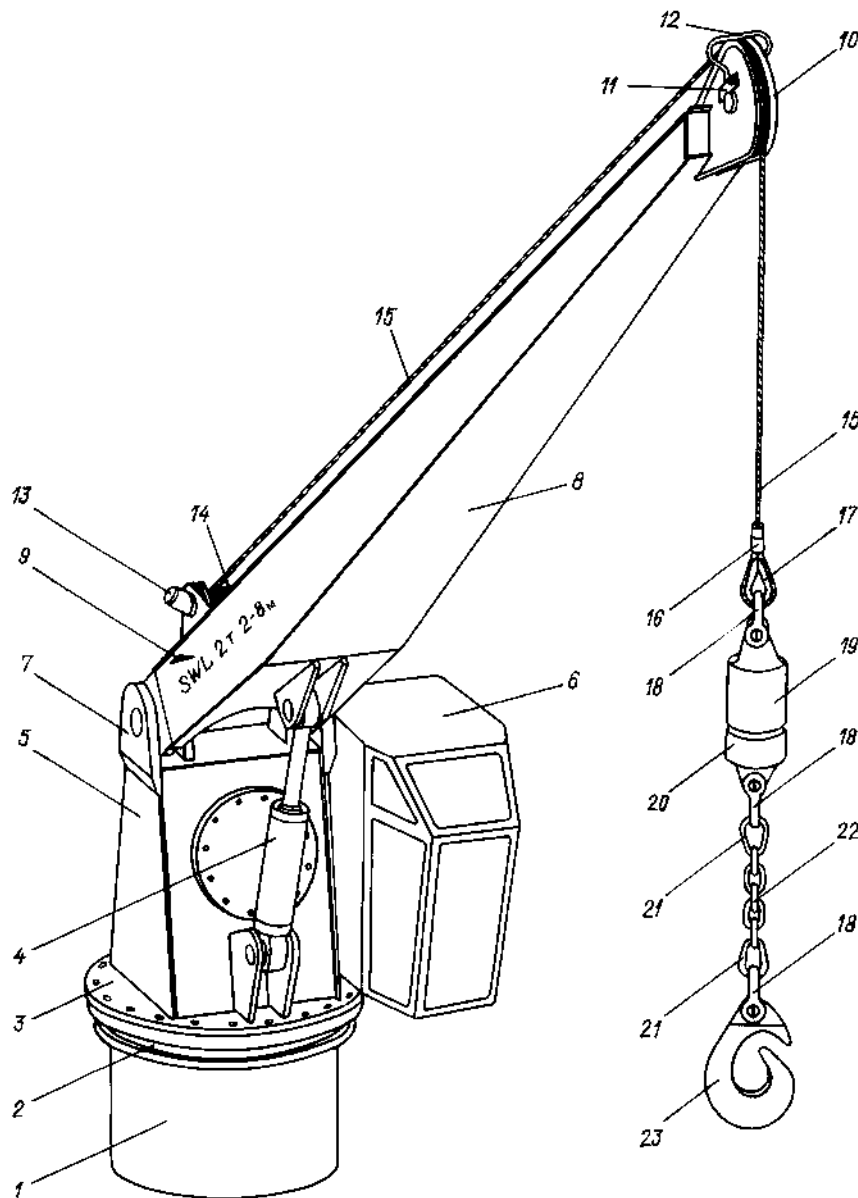

Fig. 5 Deck full-swing crane

- |  |                        |
|--|------------------------|
| 1. Crane post                              | 13. Hydraulic motor    |
| 2. Supporting and turning circle           | 14. Topping winch      |
| 3. Crane turning part                      | 15. Cargo runner       |
| 4. Luffing hydraulic cylinder              | 16. Rope sockets       |
| 5. Crane machinery space                   | 17. Thimble            |
| 6. Operator's cabin                        | 18. Connecting shackle |
| 7. Derrick heel bearing                    | 19. Counterweight      |
| 8. Derrick                                 | 20. Swivel             |
| 9. Marking                                 | 21. Connecting link    |
| 10. Guard plate                            | 22. Chain              |
| 11. Stopper plate                          | 23. Cargo hook         |
| 12. Rope guard against slipping off sheave |                        |

**.3 lifts:**

metal structures;  
lift equipment;  
lift winches;  
safety devices;  
ropes and parts for rope system;

**.4 ship elevating platforms:**

platforms;  
platform equipment;  
load-bearing components;  
safety devices;

**.5 machinery drives;****.6 electrical equipment of cargo handling gear;****.7 boilers and pressure vessels used in cargo handling gear;****.8 pumping and piping of cargo handling gear.**

The nomenclature of essential structures, machinery and components of cargo handling gear subject to the Register survey is given in the Appendix.

**1.3.4** Survey during manufacture, installation on board ship and repairs of cargo handling gear, their machinery, metal structures, components and safety devices is conducted in compliance with General Regulations for the Classification and Other Activity.

**1.3.5** Survey of machinery, hydraulic and steam drives of machinery, pumping and piping, electrical equipment, components and materials as well as boilers and pressure vessels which are not covered by the specific requirements of these Rules shall be based on the applicable requirements of the relevant parts of Rules for the Classification and Construction of Sea-Going Ships.

Where, however, the requirements contained in these Rules are equivalent to, or different from those of the relevant parts of Rules for the Classification and Construction of Sea-Going Ships, preference shall be given to these Rules.

**1.3.6** Survey of ship derricks, cranes and hoists of fishing vessels used with fishing gear as well of ship stationary derricks intended for operation in union purchase rig with derricks of another ship is carried out in the same way as in case of ordinary cargo handling gear for lifting loads of a specified weight, i.e. the Register does not participate in determination of the lifting capacity required for operation with the fishing gear, relating this to the competence of the shipowner.

**1.3.7** Survey of derrick cranes, hoists of cat davit and telfer types is carried out as that of ship cranes, and survey of hoists of heavy purchase or whip types is similar to that of the appropriate components of ship derricks.

**1.4 TECHNICAL DOCUMENTATION**

**1.4.1** Technical documentation submitted to the Register for consideration shall include:

**.1** Specification (Explanatory Note);

**.2** general arrangement plans of the cargo handling gear with indication of principal characteristics (safe working load, operation areas, outreach, cargo lifting and lowering speed, maximum and minimum outreach, slewing speed, etc.);

**.3** general arrangement plans of cargo masts with derricks, ship cranes, hoists, lifts and ship elevating platforms, their attachments to ship structures and hull strengthening in way of their installation;

**.4** drawing (scheme) of derrick and crane rigging;

**.5** drawings of metal structures (cargo masts, derricks, bridges, gantries, understructures, supporting and slewing gear of cranes, trunks, cars and ship lift guides, platforms and guides of ship elevating platforms, etc.) with strength and stability calculations;

**.6** technical documentation on machinery and drives:

assembly drawings with sections;

drawings of cargo shafts, gear wheels and pinions of reduction gear units as well as couplings (may be submitted together with assembly drawings);

basic diagrams of hydraulic units;

drawings of bed frames and housings together with particulars on welding (may be submitted together with assembly drawings);

strength calculations or calculation results of essential stress-bearing items;

explanatory note or description with indication of principal technical characteristics;

testing programmes for the prototype and a serial specimen of the machinery;

**.7** technical documentation on electrical equipment:

description of the operation principle and main performance specifications;

specification including the list of associated items, devices and materials;

structural assembly drawings;

circuit diagram of the electric drive;

testing programme;

**.8** drawings of components of the cargo handling gear together with strength calculations or with particulars proving their strength as equivalent to that of the standard components approved by the Register;

**.9** drawings of safety devices (together with strength calculations where necessary);

**.10** drawings of securing of the cargo handling gear in the stowed for sea position;

**.11** diagrams of forces acting on stressed items of the cargo handling gear;

**.12** strength calculations or results of calculations for load-bearing structures as well as stability calculations of jib cranes and rope-suspended jib booms;

**.13** instructions for derricks operating in union purchase rig with indication of the working range, safe working load, types, sizes and scheme of rigging;

**.14** testing programme of the cargo handling gear in assembly at the manufacturer.

**1.4.2** Technical documentation on cranes, winches, metal structures, gear and safety devices of cargo handling gear may be submitted separately (independent of the ship technical documentation), the types and purposes of the ships and floating facilities for which they are designed shall be, however, indicated.

**1.4.3** Use of metal structures, gear, machinery and devices manufactured according to the standards and specifications agreed upon with, or approved by, the Register does need special approval. No approval is specially needed either for use of the processes, heat treatment and calculations which comply with the standards and specifications approved by the Register.

**1.4.4** Where needed, the Register may request submission of strength calculations for ship structures and hull strengthening in places where masts, posts, winches, cranes, hoists, eye plates are fitted and where derricks and cranes are stowed for sea.

**1.4.5** Where the cargo handling gear has been altered due to modernization or repairs, the scope of the documents submitted shall be consistent with alterations made, having regard to their effect on the compliance with the requirements of these Rules.

**1.4.6** Where a cargo handling appliance which has been manufactured according to the design not approved by the Register is submitted to the initial survey, the scope of the required technical documentation, including check calculations, shall be based on the list referred to in 1.4.1.

In certain cases, the technical documentation required may be reduced upon agreement with the Register, taking into account the documents issued by manufacturers and other classification societies (see also 11.1.4).

## 1.5 GENERAL TECHNICAL REQUIREMENTS

**1.5.1** All cargo handling gear, their metal structures, machinery, gear and devices shall be designed and constructed in compliance with these

Rules and standards in force, agreed upon with the Register. Safe operation of the cargo handling gear shall be ensured with the specified heel and trim of the ship at the maximum jib radius and within the specified range of the ambient temperatures.

### 1.5.2 Machinery (drives) and brakes.

**1.5.2.1** Mechanical, hydraulic and steam drives, pumping and piping, electrical equipment where not covered by the specific requirements of these Rules shall comply with applicable requirements of Part VIII "Systems and Piping", Sections 6 and 7, Part IX "Machinery" and Part XI "Electrical Equipment" of Rules for the Classification and Construction of Sea-Going Ships.

**1.5.2.2** The cargo handling gear machinery with a coupling between the machinery and the drive as well as the machinery used for changing speed of transportation shall be so designed as to prevent falling of the load or uncontrolled movement of the boom or crane when the drive is disconnected or when the speed is changed.

The hydraulically-driven machinery shall be provided with devices to prevent falling of the load or uncontrolled movement of the boom or crane in case of a pressure drop in the hydraulic system.

**1.5.2.3** The hoisting and luffing machinery shall be so constructed that load or boom could be lowered only by using a drive.

Provision shall be made for means enabling to safely stop and lower the load in case of emergency.

**1.5.2.4** All the machinery of the cargo handling gear other than screw-driven machinery with self-braking or machinery driven from hydraulic cylinders provided with pilot controlled check valves shall be fitted with automatic brakes capable to ensure braking with a safety factor specified in the relevant chapters of these Rules.

The safety factor of braking action is the ratio of the torque exerted by the brakes to the static torque created on the braking shaft by the maximum design tension in the rope (for machinery used for topping, luffing and slewing operations with the help of the ropes) and by the design value of the inertia forces (for machinery with rigid kinematic coupling, such as machinery used for turning and movement of cranes and for luffing crane jibs).

The design shall be such that the operating solenoid could not be excited by the return electromotive force from an engine, by parasitic or stray currents or by a puncture of insulation. Provision shall be made for manual release of brakes in emergency when power supply to electric drives of the hoisting machinery fails.

**1.5.2.5** An automatic brake shall be actuated:

when a control lever returns to the neutral position;

in case of emergency disconnection of a mechanical drive;

in case of power supply failure, including total disconnection of phases or substantial voltage drop.

**1.5.2.6** Brakes shall be of a closed-band type, unless otherwise specified in the relevant chapters of the Rules and they shall be applied smoothly, without any throws; they have to have simple and readily accessible means of adjustment and enable easy replacement of the friction parts.

**1.5.2.7** Machinery and their bed plates shall be capable of withstanding the forces set up during braking.

**1.5.2.8** The forces for operation of adjustable brakes shall not exceed 160 N on a handle or lever and 310 N on a foot pedal. For brakes regularly used under normal operating conditions the forces shall be at least halved. The brake pedals shall have a non-skid surface.

**1.5.2.9** The hoisting and luffing machinery of the cargo handling gear specially intended for loading, unloading and transportation of dangerous cargoes shall be provided with two automatic independent closed-band brakes capable of holding the load (jib) with one brake in case of power failure. The brakes may be actuated consecutively.

Where there is a coupling between the engine and the reduction gear, one brake shall be fitted on the half-coupling on the side of the reduction gear or on the shaft of the reduction gear. The other brake may be positioned on the engine shaft or at any point of the driving mechanism. The brakes shall be so arranged that in order to check the reliable operation of one of the brakes, the action of the other brake is easily prevented.

The hoisting and luffing machinery driven from hydraulic cylinders the second device equivalent to a brake may be omitted.

**1.5.2.10** Manually-driven hoisting machinery shall be provided with a self-locking gear or a "safety handle" which is a handle and a ratchet built into a brake. Other devices (a hydraulic drive with a hand pump) which prevent the load from spontaneous lowering may be used.

**1.5.2.11** Manually-driven cargo handling gear shall be so designed that a force to be applied by each operator is not in excess of 160 N. Manually operated pull chains shall be protected against falling off the chain wheel.

**1.5.2.12** Means shall be provided to secure adjustable disconnected brakes in the closed position. The braking force may not be created by brake loads. Brake springs used for this purpose shall be of a push type and have guides in the form of liners or holders.

**1.5.2.13** A brake placed between the engine and the transmission shall be positioned on the transmission shaft.

**1.5.2.14** Where several items of machinery are served by one drive, brakes shall be fitted on each item.

**1.5.2.15** The brake drum shall be protected against rain, sea water, snow, ice, oils or fats unless the brake is designed for operation without such protection.

**1.5.2.16** Any (hand, foot or automatic) brake shall develop a braking torque which is by 25 per cent more than the torque required under most unfavourable conditions of operation with maximum-weight load, irrespective of the losses in the transmissions.

### **1.5.3 Electrical drives.**

**1.5.3.1** Electrical drives of the cargo handling gear provided with mechanical ventilation shall have an interlocking gear to prevent starting or further operation of the drive with ventilation cut off.

**1.5.3.2** The movable part of the deck crane shall be earthed with a special cable connected to the turning part or to a rotating drum by a current collector having at least two brushes.

Movable parts of cargo handling gear may be earthed through rollers or tracks, provided a good contact is ensured.

### **1.5.4 Hydraulic systems.**

**1.5.4.1** The dimensions and design of hydraulic systems shall meet the established technical standards on the hydraulic systems. Safe operation of the hydraulic systems under all envisaged service conditions shall be ensured by suitable measures, such as selection of filters, coolers, control devices, primary-circuit pressure control, selection of a suitable hydraulic oil, etc.

**1.5.4.2** The hydraulic system shall be so constructed that an pressure rise above the permissible value is prevented. The limits of the piston extreme positions in servomotors shall be specified.

**1.5.4.3** Pipe connections shall be made by high pressure hoses. The hoses shall be suitable for the particular working fluids, pressures, temperatures, environmental conditions and shall meet the requirements of the recognized standards.

The breaking pressure of a hose shall be equal to at least triple pressure set for the safety valve.

Threaded sleeves with locking pins and a seam may be used upon special agreement with the Register.

**1.5.4.4** The piping system may be connected to another hydraulic system, for which such connection is allowed. In this case, a second pump unit and the provision of suitable shut-off valves are recommended.

**1.5.4.5** The hydraulic pipes between servomotors or hydraulic motors shall be made with a higher degree of safety. This also relates to all the devices connected thereto.

For materials not having Test Certificate the safety factor shall be at least 2 relative to the yield stress and at least 2,5 relative to fatigue strength.

Flanged bolted connections shall be tested for tightness by a pressure equal to 1,5 times the design pressure or 1,5 times the maximum working pressure.

**1.5.4.6** Hydraulic servomotors shall be provided with devices fitted directly on the cylinder and operating in case a crack in the system to prevent fast falling of the load, jib or spontaneous turning of the cargo handling gear.

**1.5.4.7** Hydraulic servomotors shall be installed and connected to load-bearing metal structures so that no external forces affect the piston rod.

### **1.5.5 Winch drums.**

**1.5.5.1** The length of the winch drums shall be such that the rope can be wound onto the drum in one layer as far as possible; in any case, the number of rope layers shall not be more than three. The exception may be made for heavy-lift cargo handling gear or twin span tackle derricks, provided there is a rope-coiling trolley or rope pressing roller. Use of drums with coiling a rope in more than three layers is subject to special consideration by the Register in each particular case.

**1.5.5.2** A diameter of the drum shall be not less than 18 rope diameters.

**1.5.5.3** A rope drum intended for multi-layer coiling of the rope shall be fitted with flanges on both ends, which shall extend above the top layer of the rope by at least 2,5 times the rope diameter.

Grooved drums intended for one-layer reeling of two rope runs may not be fitted with flanges, provided the runs are coiled from the edges of the drum to its centre. Where one rope run is coiled on the grooved drum the flange may be omitted on the side where the rope is fastened to the drum.

**1.5.5.4** Drums of motor-driven winches where the rope is coiled onto the drum in a single layer shall have a shell with a helical groove made so that:

**.1** a groove bottom radius exceeds in the cross-section the rope radius by at least 10 per cent;

**.2** an arc length of the radius-bent groove bottom corresponds to a sector with an angle equal to at least 120°;

**.3** a gap between to adjacent coils shall be sufficient for a rope uncoiled from the drum not to touch the other coil;

**.4** the groove width in the cross-section increases in the direction from the bottom outside, where necessary.

**1.5.5.5** Span rope and cargo drums of winches operating with ship cranes, derricks or derrick cranes shall be suitable for coiling the working length of the rope necessary to lift the load from the floor of the ship hold with the derrick being in its extreme

working position as well as from the hold floor of the barge moored alongside the ship with the maximum outreach of the boom and at the least draught of the ship.

**1.5.5.6** The number of the full coils which remain on the drum when the entire length of the is unreeled shall be at least:

three for flat drums (with no grooves) and

two for grooved drums, provided:

one coil shall remain on the winch drum of the derrick or crane lowered on the supports in the stowed for sea position;

two coils on the winch drum of the derrick with the boom in its lowest stowed for sea position;

three coils in case of a travelling crane with the boom lowered in its horizontal position for removal or addition of a jib section;

three coils for a derrick crane on rigid supports with the boom in its lowest stowed for sea position.

**1.5.5.7** The drum shall be so positioned that proper coiling of the rope thereon shall be ensured. The deflection of the rope in relation to the plane normal to the axis of the drum shall not exceed 4°.

It is recommended that all drums which cannot be seen by the operator in the course of operation be fitted with a guide-on system for satisfactory running of the rope on to the drum.

### **1.5.6 Securing of gear and ropes.**

**1.5.6.1** Fixed axles with support gear rotating thereon (drums, sheaves, wheels, rollers, etc.) shall be efficiently secured to prevent their turning and their axial displacement.

**1.5.6.2** All bolted, keyed and wedged connections in cargo handling gear shall be protected from inadvertent loosening and release.

**1.5.6.3** Interchangeable components shall be so secured that their bending or twisting is prevented, for which purpose use may be made of swivels. Where twisting of the cargo runner may occur, provision shall be made for a swivel in the suspension system of the cargo-gripping device. Use may be made of swivels with ball and roller bearings, their regular lubrication shall be provided. Swivels shall freely turn under the load.

**1.5.6.4** The ends of the ropes attached to metal structures and gear shall be fitted with thimbles or be built in rope sockets or clips of the design approved by the Register. The ends of the ropes attached to the winch drums may have no thimbles or sockets. In this case, a reliable attachment of the rope to the drum shall be ensured. There shall be at least two pressing devices using the force of friction.

**1.5.6.5** The running ends of heavy-lift derrick guy tackle shall be securely attached to the guy winch drums.

Where reels are used for fastening preventer guys with derricks in union purchase rig, provision shall be made for reliable attachment of the ropes to the drums.

**1.5.6.6** Rope sheaves, blocks and rope ends attached to metal structures shall be so positioned as to prevent the ropes from slipping off the drums and block sheaves and also to prevent their rubbing in relation to one another or a metal structure. Attachment of ropes shall be designed for the greatest static force produced by a test load.

**1.5.6.7** Derricks and hoists intended for handling fishing gear may be used together with deck machinery other than cargo winches, with winding of the cargo rope, in the course of operations with fishing gear, onto the warping drums of the deck machinery and the free end of the cargo rope held by hands.

In such a case, for testing the cargo handling gear the rope shall be reliably secured onto the warping. In all other respects, relevant requirements of these Rules shall be applied to the deck machinery used for the above purposes.

**1.5.7 Controls and power supply.**

**1.5.7.1** Machinery controls of cargo handling gear shall be so made and fitted that the direction of movement of handles, levers or wheels corresponds to that of the load movement, namely: rotation of the wheel clockwise shall correspond to load lifting, boom topping and slewing to the right; pulling of the vertical lever or lifting of the slanted lever shall correspond to load lifting or boom topping; movement of the lever to the right to slewing to the right.

**1.5.7.2** Handles, levers and wheels shall be fixed in zero and working positions (with step control) and be marked. By "fixing" is meant keeping a control in the zero and working positions when a force required to shift it from the position is greater than that for moving the control between the fixed positions.

Moreover, provision shall be made for interlocking the handles, levers and wheels in the zero position.

The handles, levers and wheels shall be so arranged that their easy use is provided.

**1.5.7.3** Controls of cargo handling gear shall prevent simultaneous operation of more than two items of machinery. This requirement shall not be applied to the cargo handling gear, in the construction of which provision is made for combination of several movements.

**1.5.7.4** The force to be applied to hand-operated controls shall not exceed 120 N for hand- and 300 N for foot-operated drive. The force required for control of frequently operated handles, wheels, pedals and other controls shall not exceed 40 N.

For seldom operated controls a force not exceeding 160 N may be permitted.

The travel of the control lever shall not exceed:  
60 cm in case of manual operation;  
25 cm in case of foot operation.

**1.5.7.5** In case of push-button controls, a separate button shall be used for each direction of movement.

Push-buttons shall be provided with spring-loaded or another device for self-return to the "stop" position when the operator removes his hand or relaxes its force. The device shall not require an effort which causes operator's tiredness.

**1.5.7.6** Controls and instruments shall be arranged at the control panel so that they can be seen by the operator. The directions of movements and functions they are intended for shall be clearly and indelibly indicated thereon.

The starting levers shall have a symbol and an inscription showing the direction of their movement to start the particular device.

The inscriptions shall be made in Russian and in English.

**1.5.7.7** Controls of the cargo handling gear (controllers, knife-switches, push-buttons, etc.) designed for transportation of dangerous goods or occasional conveyance of people in man-riding cages as well as controls used in the portable remote control panels shall be provided with a device for self-return to the zero position.

Where, in case of remote control, the operator cannot see the winch drum, proper winding of the rope onto the drum shall be ensured (see also 1.5.5.7).

**1.5.7.8** The valves connecting the deck steam line to the lifting machinery shall be positioned in the vicinity of the machinery, be accessible at any time and easy in maintenance.

**1.5.7.9** The wheels intended for placing into operation shall be provided with symbols and inscriptions showing the direction of their rotation for opening of the devices and placing them into operation.

**1.5.7.10** Where a cargo winch is fitted with a variable-speed transmission and where speed levers in the neutral position enable the drum to rotate freely, a stand-by brake shall be provided on the drum side according to 1.5.2.10. The speed lever of the transmission shall have an interlocking device to prevent disconnection of the transmission during lifting or lowering of the load.

**1.5.7.11** Power supply to the coil of the magnetic brake shall prevent accidental power supply in the generation mode of the motor operation due to stray currents or as a result of an insulation puncture.

**1.5.7.12** In electrically-driven cargo handling gear power supply to motors shall not be possible until the

appropriate handles, wheels and levers at the control stations are set in the zero position.

It is recommended that provision be made for signalling of the voltage availability in the mains as well as for on/off visual indication of the electric drive.

**1.5.7.13** Short-circuits and other failures in the control circuits of the electric drives shall not result in their starting or further operation, release of brakes or keeping them released.

Where no power is supplied in the control circuits, all operating machinery shall automatically stop also in case when controls are not in the zero position.

**1.5.7.14** The control circuits with independent electric drives of span and preventer guy reels shall prevent the drives from starting or further operation with a load on the hook.

Instead of interlocking, provision may be made for starting the above drives only by authorized persons of the ship personnel.

**1.5.7.15** A button or a safety switch for disconnection of the main circuit of the electric drive shall be provided within the reach of the operator's hand directly at the control station of the cargo handling gear. They shall be painted red and bear an inscription "STOP".

No switch is required for hydraulic drives with a mechanism for control lever self-return to the zero position.

**1.5.7.16** A switch accessible only for authorised persons of the ship crew shall be provided in the main circuit of the cargo handling gear or provision shall be made for locking the switch in the position.

**1.5.7.17** Use of bare trolley wires for power supply of travelling cargo handling gear is not allowed.

**1.5.7.18** Any possibility of spontaneous switching on of the electric drive shall be prevented.

The motor of the hoisting machinery shall start only after the control handle moves from the neutral position.

## 1.6 SPECIAL REQUIREMENTS

**1.6.1** In order to prevent spark formation during cargo handling operations on board oil tankers, oil recovery vessels, gas carriers, chemical tankers and other similar ships, such gear as cargo hooks, shackles, swivels, chains, etc. shall be of an intrinsically safe type to comply with the recognized standards.

## 2 CALCULATIONS

### 2.1 GENERAL

**2.1.1** Methods for calculation of forces and stresses in structural elements of cargo handling gear are not governed by these Rules but the Register may require in separate cases that the calculation methods approved by the Society are applied.

Recommended methods of calculations for cargo handling gear are given in the Book of the USSR Register Normative Documents and Procedures (Vol. 2) 1980.

**2.1.2** For derrick cranes, hoists of cat davit and telpher types the appropriate methods of calculating ship's cranes shall be applied; for hoists of cargo purchase and whip types, calculation methods used for ship derricks shall be applied.

The latter methods, having regard to the provision of 2.2.2 and 2.3.16, shall be also applied to loose gear.

For cranes used on mobile offshore drilling units, calculation methods of ship cranes shall be applied with due regard for specifics of their operation.

### 2.2 DESIGN LOADS AND STRESSES

**2.2.1** Design loads for ship derricks, ship cranes and hoists, upper structures of floating docks and crane ships, ship lifts and ship elevating platforms are given in the relevant sections of these Rules.

**2.2.2** Used as a design load for loose gear is the weight of a safely lifted load and a dead load.

For spreaders it shall be assumed that the centre of gravity of a container may deviate from the geometrical centre by up to 1/10 of the container length and breadth.

A special case of loading shall be also applied to spreaders where the pay load is taken only by three rotary gripping heads.

For loose gear suspended at four hoisting ropes without making the rope lengths equal, strength shall be proved for the case when the pay load is unfavourably applied to three ropes only.

**2.2.3** The following shall be taken into account in calculations of machinery of cargo handling gear:

.1 design loads of the machinery shall be determined with regard to the loads of the cargo handling gear and conditions for determination of forces in structural elements;

.2 safety factors of machinery items shall be not less than those of metal structures of cargo handling gear;

.3 gear wheels shall meet the requirements of 4.2, Part IX "Machinery" of Rules for the Classification and Construction of Sea-Going Ships.

**2.2.4** Friction losses in block sheaves and in rope bending on the sheaves shall be taken equal to 5 per cent for each sheave with a sliding bearing and 2 per cent for sheaves with anti-friction bearings.

Variation of forces in the structural components of the cargo handling gear when the ropes are pulled through the blocks shall be considered for the motion or motions that are the most unfavourable for the gear (hoisting and lowering a load or a topping a boom).

**2.2.5** When compressed beams and compressed beams with an applied bending moment shall be calculated, account shall be taken with adequate accuracy of the effect of the longitudinal forces on the stress value, having regard to the eccentricity of their application, structural camber and initial curvature due to dead load (see also 2.3.12).

**2.2.6** Where normal and tangential stresses are effective in the cross-section, the resultant stress  $\sigma_{res}$  shall be determined, by the formula:

$$\sigma_{res} = \sqrt{\sigma^2 + 3\tau^2} \quad (2.2.6)$$

where

$\sigma$  = normal stress in the cross-section considered, MPa;  
 $\tau$  = tangential stress in the cross-section considered, MPa.

The strength shall be checked against these stresses.

**2.2.7** The design modulus of elasticity for steel wire ropes shall be taken equal to 98 GPa.

**2.2.8** When strength of riveted or bolted structures is calculated, crosssectional areas and section moduli shall be determined with the hole areas deducted. No deduction of the hole areas are required in stability calculations.

**2.3 ALLOWABLE STRESSES, SAFETY FACTORS AND STABILITY MARGIN**

**2.3.1** The stresses in metal structures of ship cargo handling gear under the effect of the design loads shall not exceed the allowable values given in Table 2.3.1.

For masts with several light-weight single derricks used simultaneously, the allowable stresses may be assumed equal to 0,5 of the yield stress  $R_{eH}$  of the material.

The allowable stresses in stayed masts shall be taken by 10 per cent less than the above values.

For manually operated cargo handling gear the allowable stresses may be taken equal to 0,6 of the yield stress  $R_{eH}$  of the material.

The safe working load (SWL) of ropes (wire, natural fibre and synthetic ropes) shall not exceed the guaranteed breaking load  $F_{guar}$  established by a specimen testing (with the above ropes) divided by the safety factor given in Table 2.3.7 and Table 2.3.8.

**2.3.2** The values of allowable stresses specified in Table 2.3.1 include the following dynamic load factors:

$$\psi_H = 0,7R_{eH}/\sigma \quad (2.3.2-1)$$

where

$\psi_H$  = the standard dynamic factor obtained as the ratio of the maximum anticipated dynamic load to the static stress under the action of the design load;

$R_{eH}/\sigma$  = safety factor according to Table 2.3.1.

When the maximum cargo hoisting or lowering speed is more than 1,33 ( $\psi_H - 1$ ) m/s the dynamic load factor shall be checked by calculation, using the formula

$$\psi = 1 + 0,318 \frac{v}{\sqrt{f_{st}}} \quad (2.3.2-2)$$

where

$\psi$  = dynamic load factor obtained as the ratio of the dynamic load to its static value;

$v$  = maximum speed of load movement, m/s;

$f_{st}$  = calculated vertical shifting of the load suspension point (including variation in the rope length) under the action of a static force induced by cargo weight equal to the safe working load, m.

Table 2.3.1

| Safe working load, t | Allowable stresses as fractions of yield stress of material, $\sigma/R_{eH}$ | Safety factor, $R_{eH}/\sigma$ | Dynamic factor, $\psi_H = 0,7R_{eH}/\sigma$ | Maximum cargo hoisting or lowering speed at which check calculation $\psi_H$ is not mandatory, m/s |
|----------------------|--|--------------------------------|---|--|
| 5 and less           | 0,40   | 2,50                           | 1,75  | 1,00   |
| 10                   | 0,42   | 2,38                           | 1,67  | 0,89   |
| 15                   | 0,44   | 2,27                           | 1,59  | 0,78   |
| 20                   | 0,46   | 2,18                           | 1,52  | 0,69   |
| 25                   | 0,48   | 2,08                           | 1,46  | 0,61   |
| 30                   | 0,50   | 2,00                           | 1,40  | 0,53   |
| 40                   | 0,54   | 1,85                           | 1,30  | 0,40   |
| 50                   | 0,57   | 1,76                           | 1,23  | 0,31   |
| 60                   | 0,59   | 1,70                           | 1,19  | 0,25   |
| 75 and more          | 0,60   | 1,67                           | 1,17  | 0,22   |

Note. Intermediate values shall be determined by interpolation



If the calculated dynamic load factor  $\psi$  exceeds  $\psi_H$ , the allowable stresses indicated in 2.3.1 shall be multiplied by  $\psi_H/\psi$ ; if the calculated dynamic load factor is equal to, or less than  $\psi_H$ , the allowable stresses are assumed equal to those given in 2.3.1.

On agreement with the Register other methods may be used for calculation of dynamic load factor.

**2.3.3** In calculation of the allowable stresses in metal structures, the yield stress guaranteed by the standard or specifications shall be taken as the basis for calculations; in all cases, however, it shall not exceed 0,70 of the minimum tensile strength guaranteed by the standard or specifications.

**2.3.4** The allowable stresses indicated in 2.3.1 relate to tensile, compression and bending deformations and reduced stresses. The recommended transition coefficients of allowable stresses for other deformations as well as of those for calculation of welded, riveted and bolted connections are given in the Register Book of Normative Documents and Procedures (Vol. 2), 1980.

**2.3.5** The design and dimensions of interchangeable components shall be such as to prevent permanent deformations when tested with a proof load as specified in 10.2.1 and breaking when tested with an ultimate load according to 10.2.9. Items of interchangeable components which are manufactured in accordance with the standards and normative documents approved by the Register are considered as meeting the requirement.

The allowable stresses in non-standard fixed gear shall not exceed those assumed for metal structures (see 2.3.1 to 2.3.4).

**2.3.6** The safety factor of span chains, chains of cargo runners, preventer guys and loose gear in relation to the breaking load shall not be less than 4.

For calibrated chains used with sprockets in manually operated hoists the safety factor shall be not less than 3,2. For chains used with sprockets in power-operated hoists the safety factor shall be specially considered by the Register in each particular case.

**2.3.7** The safety factor of the steel wire ropes in relation to the breaking load of the rope as a whole shall be not less than the values given in Table 2.3.7.

Table 2.3.7

| Wire ropes  | Safety factor with safe working load, t |                                      |              |
|---|---|--------------------------------------|--------------|
|   | 10 and less                             | 11 — 160                             | 161 and more |
| Cargo runners, span ropes, guy tackles, cargo and span ropes of cranes, ropes of loose gear | 5                                       | $\frac{10^4}{8,85 \cdot SWL + 1910}$ | 3            |
|   | 10 and less                             | 30                                   | 50 and more  |
| Shrouds, stays, guy pendants and preventer guys   | 4                                       | 3,5                                  | 3            |

**2.3.8** The safety factor of natural fibre ropes in relation to the breaking load of the rope as a whole shall be not less than the values given in Table 2.3.8 and the safety factor of synthetic ropes shall not be less than 10.

Table 2.3.8

| Nominal diameter of natural fibre ropes, mm | Safety factor |
|---|---------------|
| 12  | 12            |
| 14 — 17                                     | 10            |
| 18 — 23                                     | 8             |
| 24 — 39                                     | 7             |
| 40 and more                                 | 6             |

**2.3.9** The stability margin shall be not less than the safety factor (in relation to the yield point) for the compression of the same element.

**2.3.10** Compressed beams shall be checked for overall stability and their thin-walled parts, for local stability. If they comply with the requirements of 4.3.3, tubular members need not be checked for local stability.

Beams subject to transverse bending shall be checked for overall stability and their vertical walls and compressed flanges, for local stability.

**2.3.11** The critical load of axially compressed beams shall be determined with due regard for initial eccentricity of the longitudinal forces and the initial bend; the total value of both shall not be less than 0,001 of the beam length.

**2.3.12** Ship steel derricks may be calculated, using the assumed stability margin determined with due regard for variation of the cross-section along the length of the derrick but with no account of the initial eccentricity and bend. This value shall not be less than 4,5.

**2.3.13** Flexibility of each portion of the axially compressed beams with varying cross-section as taken between the connecting members (plates or lattices) shall be not less than 40.

**2.3.14** Flexibility of compressed and expanded members of metallic structures shall not exceed the values given in Table 2.3.14.

Table 2.3.14

| Members of metal structures                                 | Flexibility of members |          |
|---|------------------------|----------|
|   | Compressed             | Expanded |
| Chords of main trusses                                      | 120                    | 150      |
| Single-beam structure of derricks, posts and masts          | 150                    | 180      |
| Other beams of main trusses and chords of auxiliary trusses | 150                    | 250      |
| All other beams   | 250                    | 350      |

In calculating flexibility, the design length shall be taken with due regard for the type of end fixing. The flexibility shall be determined in the planes of the main inertia forces.

The flexibility of derrick booms may be assumed to be 175, and with the axial force 19,60 kN and less it may be taken equal to 200.

**2.3.15** The stresses in metal constructions of the upper structures when subject to the action of design loads are not to exceed the allowable stresses given in Table 2.3.15 with due regard for the provisions of 2.3.3 and 2.3.4.

Table 2.3.15

| Combination of maximum loads | Allowable stresses in parts of yield stress, $\sigma/R_{eH}$ |
|------------------------------|--|
| Under working conditions     | 0,70   |
| Under non-working conditions | 0,75   |

### 3 MATERIALS AND WELDING

#### 3.1 MATERIALS

**3.1.1** The materials used in the manufacture of stress-bearing metal structures, machinery and gear of cargo handling gear, as well as heat treatment of forged and cast items, where not covered by the specific requirements of these Rules, shall comply with the appropriate requirements of Part XIII "Materials" of Rules for the Classification and Construction of Sea-Going Ships.

**3.1.2** All stress-bearing parts and fittings of metal structures, machinery and gear other than those referred to 3.1.3 and 3.1.4 shall be made of steel; use of other materials shall be subject to special consideration by the Register in each particular case.

**3.1.3** The first grade timber may be used for side plates of blocks for natural fibre or synthetic ropes.

**3.1.4** Cast iron may be used for manufacture of the following items:

- .1 gear, worm and travelling wheels of hand-operated cargo handling gear;
- .2 worm wheels with a bronze rim;
- .3 drums and whipping drums of winches, gear boxes and sheaves of blocks;
- .4 brake shoes, drum brackets and bearing bodies;
- .5 casings and units of hydraulic equipment, hydraulic engines, pumps.

**3.1.5** Use of cast steel for items other than cast items allowed by these Rules shall be subject to special consideration by the Register in each particular case.

**3.1.6** Steel grades used for stress-bearing elements of metal structures of cargo handling gear and cargo-gripping devices shall be chosen in compliance with Tables 3.2.2-1 and 3.2.2-2, Part XIII "Materials" of

For upper structures of a simple construction the design loads applied as to ship cranes (see 6.2.3), the allowable stresses shall be taken in accordance with 2.3.1.

**2.3.16** Stresses arising in steel structures of loose gear under the effect of the loads referred to in 2.2.2 shall not exceed those given in Table 2.3.1.

During the tests of the loose gear by a proof load the stresses occurred shall not exceed  $0,8 R_{eH}$ .

When sliding bearings of loose gear are calculated, the static safety factor under the normal load shall be not less than 1,2.

The specific pressure between a spreader twist-lock and a corner fitting of the container under a static load shall not exceed 50 MPa.

Rules for the Classification and Construction of Sea-Going Ships. The steel grade shall be chosen depending on the ambient temperature in compliance with Fig. 3.1.6.

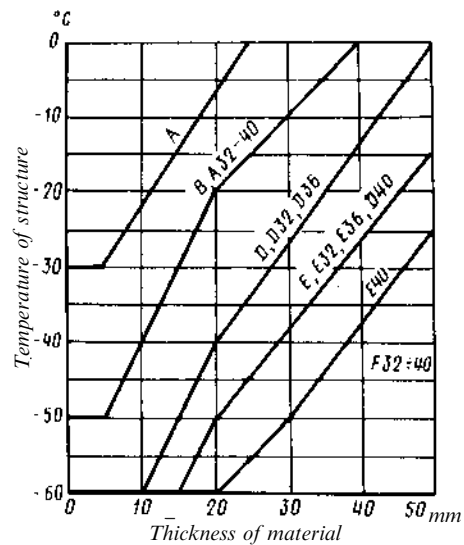

Fig. 3.1.6

**3.1.7** Where steels other than hull structural steel are used on agreement with the Register for manufacture of metal structures, they shall comply with the requirements for hull structural steels.

**3.1.8** For stress-bearing items of gear use shall be made of killed steel. Its properties shall ensure operation of cargo handling gear on open decks at temperatures below zero. Steel for stress-bearing items of interchangeable components shall have, in addition, certified elongation not less than 20 per cent after testing of five samples.

Steel used for manufacture of chains for cargo handling gear intended for operation at temperatures below  $-20\text{ }^{\circ}\text{C}$  shall meet the requirements for chain steel of grade 2 or 3 according to 3.6, Part XIII "Materials" of Rules for the Classification and Construction of Sea-Going Ships.

Chains for which no heat treatment is required for improvement of quality or strength shall be normalized after manufacture.

**3.1.9** All steel castings and forgings used in cargo handling gear, as well as welded items with stressed closely spaced or intersecting welded joints shall be heat-treated for stress relieving (castings from alloyed steels shall be quenched and tempered, castings and forgings from carbon steels shall be quenched and tempered or normalized, and electrically welded items shall be annealed).

Heat treatment of items shall be carried out in muffle furnaces under efficient control of the temperature. Heat treatment conditions shall be specified depending on the steel grade, use and size of the items and shall be agreed upon with the Register.

Heat treatment shall be confirmed by manufacturer's Certificate. The particulars of heat treatment of interchangeable components shall be entered in the Certificate using Form 5.1.4 (No. 3).

If heat treatment of the interchangeable components was supervised by a competent person, a relevant entry shall be made in Part II of the Register of Ship's Cargo Handling Gear Lifting Appliances and by the Surveyor to the Register, based on the Certificate signed by the competent person.

Welded items may not be heat treated upon special approval by the Register.

**3.1.10** Use of higher strength materials for manufacture of structures and components of cargo handling gear may be permitted upon agreement with Register provided the Rules requirements for the steels are met.

### 3.2 WELDING

**3.2.1** Use of welding in metal structures, components and machinery of cargo handling gear, quality control of welded joints and their heat treatment, where not covered by the specific requirements of these Rules, shall comply with the appropriate requirements of

Part XIV "Welding" of Rules for the Classification and Construction of Sea-Going Ships.

**3.2.2** The dimensions of fillet welds shall be assigned as small as possible based on the strength calculation and with regard to the manufacturing conditions. The leg length of a fillet weld shall not be less than 4 mm but it shall not exceed 1,2 of the least thickness of the welded items. The length of the fillet weld shall be not less than 50 mm.

Where short fillet welds are used for tee-joints of such essential components as slewing guy plates (9.2.3), lead block fastening nose (9.2.6), span eye plate (9.2.8), eye plates on ship hull and metal structures (9.2.9), special attention shall be given to the quality of welding and testing of welds. In particular, the welds shall be examined along their entire length by a method approved by the Register.

**3.2.3** Round and ring-shaped items of small diameters (chains, rod shrouds) shall be joined by resistance welding.

**3.2.4** Butt welded joints of masts, columns, derricks and other tubular, box-shaped elements shall be welded with penetration to the weld root to ensure full penetration but where there is no access use shall be made of a steel backing plate.

**3.2.5** In structures of enclosed circuit where there is no access from inside, use of plug welds is permitted for attachment of the closing plate on the inside framing (diaphragms). For the requirements for plug welds, see 1.7.5.13, Part II "Hull" of Rules for the Classification and Construction of Sea-Going Ships.

**3.2.6** On agreement with the Register, worn-out or damaged fixed gear may be repaired by welding. Repair of worn-out or damaged interchangeable components using such method may be allowed on special agreement with the Register.

**3.2.7** Weld quality of stress-bearing members of metal structures shall be examined by the radiographic or some method of non-destructive control approved by the Register. Not less than 10 per cent of the length of the welded joint tested shall be tested. Welded joint intersections shall be mandatorily examined. Circular continuous butt welds of masts, columns, derricks and other stress-bearing metal structures shall be examined over the entire length. Welds of masts (columns) intended for installation of booms with a safe working load of more than 25 t are subject to 100 per cent radiography up to a height 3,5 m above the deck of their attachment.

## 4 SHIP DERRICKS

### 4.1 GENERAL

**4.1.1** The requirements of this Section apply to ship cargo derricks of an ordinary design, which operate under the following conditions:

- single derricks with one span;
- twin span tackle derricks;
- derrick cranes;
- union purchase rig.

Derricks with special design are subject to special consideration by the Register.

**4.1.2** Typical rigging schemes for ship derrick are given in Section 1.

**4.1.3** Each derrick shall be provided with a power-operated topping winch or a span winch meeting the requirements of 4.5.2.

Where provision of a span winch is not reasonably practicable, a span chain joined to the span rope by means of a monkey or a delta plate shall be employed.

**4.1.4** The span chain of derricks shall be secured to an eye plate on the deck or mast.

Fastening of span ropes, guys and preventer guys at the expense of friction forces (rope stops, bollards, cleats) is not allowed.

**4.1.5** The lengths of a span rope and a cargo runner shall be chosen so that the minimum number of turns on the appropriate drum is not less than that required by 1.5.5.6 under all possible combinations of location and movements of booms during operation.

**4.1.6** Use of snatch hooks for leading cargo runners and span ropes is not allowed.

**4.1.7** Where a derrick winch is fitted with a common motor for raising or lowering either the jib or the load and the jib is held by a pawl engaging in the derricking drum when the motor is being used to raise or lower a load, an effective interlock shall be fitted to the pawl engagement gear so that the pawl cannot be disengaged from the drum until the motor has been positively connected to the derricking drum drive.

**4.1.8** When the cargo runner becomes slack downward movement of the block under the effect of its own weight shall be restricted. For this purpose provision shall be made in the assembly design of the block fitted to the heel of the derrick for a limiting stop or the lead block shall be provided with a duct bill.

**4.1.9** Provision shall be made to ensure efficient securing of derricks when they are stowed for sea. Where the derrick is stowed vertically along the mast during the voyage but where it cannot be adjusted in this position with the help of a span, a special arrangement shall be provided to keep it in the position.

**4.1.10** Slewing guys of derricks shall be designed so that operation of the derrick at the maximum jib

radius is ensured with the ship having a list 5° and a trim 2°.

**4.1.11** The derrick heel bearing shall be fitted above the deck where winches are installed at a height not to hinder the attending personnel and proper winding of the cargo runner on to the drum.

**4.1.12** The gooseneck of the derrick with one span and span eye plate shall be generally positioned at one vertical line. Displacement of span fitting in relation to the derrick heel is subject to special consideration by the Register in each particular case.

**4.1.13** Seatings of heavy-lift derrick goosenecks shall be adequately strong and rigid. The deck shall be strengthened in the area of the gooseneck. The heel socket of the gooseneck shall be provided with a hole for water drainage.

**4.1.14** Twin span tackle derricks shall be designed and installed in such a way as to preclude jack-knifing when in the extreme positions. Where necessary, structural measures shall be taken to limit slewing angles of the spans or derricks.

**4.1.15** Derrick cranes shall be provided with limit switches that automatically come into action in the outreach and slewing extreme positions of the derrick cranes and, when proved necessary, with other safety devices in accordance with the requirements of 5.5.

**4.1.16** The design and arrangement of union purchase rigs shall provide a possibility to operate the booms in the mode of single booms.

**4.1.17** When derricks shall be operated in union purchase rig, their outfit shall include:

**.1** adequately strong preventer guys and fittings for their attachment to the deck and derrick head;

**.2** devices for bridling cargo runners (including a check chain between the cargo runners);

**.3** arrangements enabling to control extreme positions of the derricks and preventer guys during operation as provided in the calculations and also the angle between the cargo runners, which arrangements shall be contained in the Instructions for Derricks Used in Union Purchase.

Visual control of the working position of the derricks or the limiting height of lifting a load may be used if, under actual conditions of operation, such control proved sufficiently reliable (e.g. if the limits of allowable service area or fixed positions of the derricks are governed by such ship structures as hatch comings, superstructures, deckhouses, etc.)

It is recommended that permanent indicators be used to control boom positions relative to the horizon and centreline of the ship.

Where visual control of boom positions and the included angle between cargo runners is not considered to be reliable, provision shall be made for such structural arrangements as marking of span ropes, preventer guys and preventer guy eye plates or other acceptable arrangements.

Places where preventer guys are attached and the length of the preventer guys shall be fixed structurally but not controlled visually;

.4 boom head guys or inner guys to preclude slewing of the boom towards the preventer guy.

**4.1.18** The derricks used in union purchase shall be so positioned that a load is easily carried over the top of the bulwark or hatch coaming, with a limited angle between the cargo runners not exceeding 120°.

**4.1.19** The hauling ends of guy tackle ropes of heavy-lift derricks shall be securely attached to winch drums.

Efficient attachment of ropes to the drums shall be also ensured where winches are used for securing preventer guys in union purchase rig.

**4.1.20** Loose, interchangeable and fixed gear of ship derricks shall comply with the requirements of Section 9.

## 4.2 CALCULATION

**4.2.1** In determining the loads on the components of single derricks the following angles between a boom and a horizontal shall be used: 15° for light-lift derricks; 25° for heavy-lift derricks.

If the minimum angle under actual operating conditions exceeds the above values, the minimum angle may be used in calculations.

For a built-in sheave of a cargo runner and cargo blocks with a cargo runner which is parallel to the derrick boom, the resultant load shall be calculated using the largest possible angle of boom inclination to the horizontal but not less than 60°.

**4.2.2** The maximum angle of boom inclination to the horizontal shall not exceed 70°.

**4.2.3** The maximum angle of boom slewing relative to the centre line of the ship when the boom is swung outboard shall not exceed 75°.

**4.2.4** Where the derrick heel is structurally shifted in relation to the vertical passing through the span eye plate at a value exceeding 0,025 of the eye plate height above the derrick heel, the stresses in the derrick, span and slewing guy units shall be specially calculated, having regard to limitations for the adjustment of guys and the extreme positions of the booms.

**4.2.5** For twin span tackle derricks the requirements of 4.2.1 may be applied, the only difference, however, being that the span tension shall be

determined for the maximum slewing of the derrick boom to the side opposite to the span under consideration.

Where the heel of the derrick fitted with twin span tackles is structurally shifted in relation to the vertical plane passing through the span eye fittings, the requirements of 4.2.4 may be applied.

**4.2.6** Provision shall be made to obviate the risk of horizontal jack-knifing of the twin span tackle derrick when the boom is at the maximum slewing distance from the middle position. For heavy-lift derricks account shall be taken of heel and trim angles referred to in 4.2.9. The jack-knifing is unlikely to occur if there exists a horizontal component of the span tension, which is normal to the direction of the boom in the projected plan and equal to not less than 0,1 of the derrick safe working load.

**4.2.7** When derricks are operated in union purchase rig, the stresses in the derrick gear shall be determined for the worst possible position (for the gear concerned) of the maximum safety lifted load on the trajectory defined by the limited angle between the cargo runners (see 4.1.18).

If, under actual operating conditions, derricks may be rigged in several different ways, to be included in the calculation is the one under which the greatest stresses occur; this applies also to determination of the design position of the derricks and preventer guy units when specifying the working areas to be served by the derricks in union purchase.

When derricks are operated in union purchase, the stresses in booms, cargo runners and span ropes shall generally not exceed the stresses originated in the single derrick rig. Where the stresses in the union purchase components (for example, the axial thrust down the boom) exceed those met in case of single derrick rig, the scantlings of the components in question shall be based on the stresses originated in derricks rigged in union purchase.

**4.2.8** When derricks shall be operated in union purchase rig, the derricks and preventer guy units shall be so fitted as to obviate the risk of vertical jack-knifing of derricks (tipping over) under all possible ways of rigging and positions of the load.

To preclude the risk of jack-knifing, additional inner guys may be used. Slewing guys may be used for this purpose.

The jack-knifing is not likely to occur if there is a positive tension in the span when the derrick is under load, having no regard to the own weight of the derrick and its gear.

**4.2.9** The design stress in the slewing guy units shall be not less than 25 per cent of the cargo gravity force equal to the derrick safe working load.

For heavy-lift derricks the above value shall be verified at a heel of 5° and trim 2° when the derrick is

swung fully outboard. If heel and trim are greater in operation than the above values, the actual values of heel and trim shall be used in calculations.

Where special arrangements, such as ballasting, are made to reduce the heel when working with a heavy-lift derrick, these arrangements may be taken into account in calculating the force in the guy.

The design stress in boom head guys or in union purchase tackles shall not be less than 10 per cent of the gravity force of the load corresponding to the safe working load for the single slewing derrick.

**4.2.10** Where two or more light derricks are used simultaneously on one mast, the relative position of the booms shall be assumed such where maximum stresses in the mast cross-section are produced, and if the mast is provided with standing rigging, the maximum tension which arose in the standing rigging.

Where no special proof is available, the initial tension of the standing rigging shall be taken equal to 1/12 of the breaking load of the rope as a whole.

**4.2.11** When several positions of a boom are possible, calculations shall be made for each position separately. Allowable angles of inclination shall be indicated in the Testing Certificate.

**4.2.12** For derricks the parts of which are secured on the cross-trees account shall be taken of a bending moment and a torque which may arise under conditions of uneven distribution of forces in the tackle-blocks.

**4.2.13** The safe working load shall be taken as a design load for derricks.

The derrick own weight shall be considered (except for operation in union purchase) if the derrick mass amounts to 20 per cent of the safe working load and more.

For derricks of a special (non-tubular) design wind pressure shall be taken into consideration as specified for ship cranes.

In determining tension in slewing guys of heavy-lift derricks, heel and trim shall be considered as specified in 4.2.9.

#### 4.3 CARGO MASTS

**4.3.1** Cargo masts shall have at least two props.

The deck of a sufficiently strong deckhouse or superstructure may serve as the upper prop.

The places in way of fixing the masts shall be adequately stiffened.

**4.3.2** The wall thickness of cargo masts shall not be less than 5 mm if they are arranged within enclosed spaces; it shall be not less than 6,5 mm if they stand outdoors or have no access inside and at

least 5 mm for those having access inside. Cargo masts used for ventilation purposes shall have wall thickness not less than 6,5 mm.

**4.3.3** The outside diameter of a cargo mast  $D$ , in mm, depending on the wall thickness  $t$ , in mm, shall not exceed the following relationships:

$$D = 1000t / (25 - t) \quad \text{with } t \leq 15 \text{ mm,}$$

$$D = 100t \quad \text{with } t > 15 \text{ mm.}$$

The diameter of the mast may be increased if the actual stresses in the mast are below the allowable stresses, which is subject to special consideration by the Register in each particular case (see also 2.3.1).

**4.3.4** The construction of cargo masts and their parts shall prevent water accumulation in inaccessible places. All parts other than enclosed structures shall be accessible for inspection, cleaning and painting.

**4.3.5** The design forces in cargo masts shall be determined for such position of a boom or combination of booms which cause the largest forces.

**4.3.6** Shrouds shall be so fitted as not to interfere with operation of booms or running rigging. It is not recommended that shrouds be attached to the ends of the cross-trees (cross-piece) of the mast.

**4.3.7** The ropes of the standing rigging shall be provided with rigging screws; the shroud and stay plates shall be securely attached to the ship hull; the direction of the plates shall be as indicated in 9.2.9. Use of only one item (e.g., shackle) for fastening two ropes is not allowed.

#### 4.4 DERRICK BOOMS

**4.4.1** The wall thickness of steel derrick booms shall not be less than 4 mm.

The outside diameter of derrick booms shall not exceed the values specified in 4.3.3.

The diameters of the boom sections in the area of the boom head and heel shall be not less than 0,65 of the boom diameter in its middle part.

Transverse butt welds are not allowed in the middle part of derrick booms. The arrangement of these welds shall be in accordance with the standards recognized by the Register.

The maximum structural camber of the steel boom shall not exceed 1/1500 of its length, either in the plane of the suspension or in the plane normal thereto.

**4.4.2** Eye plates for fastening guys shall be fitted as close as possible to the eye plates for fastening the cargo block in compliance with 9.2.9.

**4.4.3** Where a built-in sheave is fitted the boom shall be additionally strengthened to make a section modulus in way of the sheave not less than that of the boom without a sheave.

**4.4.4** After fitting of eye plates and a built-in sheave and upon completion of all welding operations, each boom shall be tested for tightness by air with a pressure 0,03 MPa.

**4.4.5** Quality control of welded joints is carried out by means of external examination, measurements and radiography in accordance with 3.2.7.

#### 4.5 CARGO WINCHES AND REELS

**4.5.1** Cargo winches, span winches and slewing guy winches used for changing the position of derricks under load shall comply with the requirements of 1.5. Their drive shall have a braking moment which is 1,5 times the required nominal moment.

**4.5.2** Span ropes reels and preventer guy reels shall be provided with ratches which automatically come into action when the winch drives are disconnected or fail, or when the current is switched off or power supply to the motor of independent reel drive is interrupted.

Where reels are driven by the rope from the load drum or whipping drum of the cargo winch, automatic operation may not be needed if the pawl does not rise above the ratchet by more than 15 mm.

**4.5.3** The reels driven independently shall also comply with the requirements for cargo winches (see 4.5.1), except for the requirements for the brakes of the cargo handling gear with electric drives.

**4.5.4** Where reels are driven by a rope the winch drive shall be efficiently divided by a substantial flange into two sections: for the working rope and for

the driving rope. The driving rope shall be securely fastened to the drum of the topping or similar winch, and to the load drum or to the whipping drum of the cargo winch.

**4.5.5** Winches and reels shall be installed so that the fleet angle of a rope reeled onto the drum shall be no more 4° about the plane vertical to the longitudinal axis of the drum, and adequate tension is ensured so that the rope will properly reel onto the drum, whatever the position of the derrick may be. A coiler or a pressure roller shall be provided if necessary (see 1.5.5.7).

**4.5.6** It is recommended that arrangements are made to prevent inadmissible stresses in the boom and span due to the tension in the guy winches for single span heavy-lift derricks.

**4.5.7** The ratchet-and-pawl mechanisms shall withstand the torque which is at least 1,5 times the maximum torque induced by the force in the derrick boom under the maximum load conditions.

**4.5.8** A topping winch driven by another winch through the driving rope shall not be used with a derrick boom the safe working load of which exceeds 3 tons.

**4.5.9** The rope intended for driving the topping winch:

shall not be used on a drum which may damage the rope owing to its condition and design;

shall not have more turns on the drum than that specified. Extra turns may be laid onto the drum provided with appropriate flanges;

shall not be paid out through the drum, in particular, if the rope is made of a synthetic fibre.

Performance of the chosen rope shall ensure its adequate strength and reliability in operation.

## 5 SHIP'S CRANES AND HOISTS

### 5.1 GENERAL

**5.1.1** The requirements of this Section apply to cranes and hoists with allowance for their specific operating conditions and structural features.

**5.1.2** Jib cranes shall be designed and installed in such a way as to obviate a risk of jack-knifing (see also 5.7.1).

**5.1.3** Cranes with derricks on rope suspension shall be designed in such a way as to obviate a risk of jack-knifing of the derrick to the side opposite to the outreach; due account shall be taken of heel and trim which are likely to be encountered in service; limiting stops may be used when required (see also 5.2.4).

**5.1.4** The design of ship cranes and hoists shall enable them to be securely attached to the ship's hull. The hull structure shall be adequately stiffened in the place where a crane or hoist will be installed.

**5.1.5** Provision shall be made to ensure efficient fastening of cranes, their derricks and hoists when stowed for sea.

### 5.2 CALCULATION

**5.2.1** The total design load of the ship's cranes will include:

- .1 safe working load;
- .2 crane own weight;

**3** wind pressure of 400 Pa acting on the deck crane and load surfaces in the longitudinal and transverse directions.

In stress calculations of crane elements angles of inclination shall be taken into consideration in accordance with 5.2.2.

For cranes intended for operation at rolling the design loads shall meet the requirements of 6.2.1 and 6.2.2.

**5.2.2** In calculating the wind load, the windward side of the crane shall be assumed as follows: for continuous-sided constructions it is the area outlined by the contour of the construction, and for latticed constructions it is the area outlined by the contour of the construction with the area of gaps between the beams deducted.

For cranes with equally high beams running at different levels (continuous-sided or latticed) one behind another, and with the distance between the beams less than the beam height, the windward side shall be assumed as the total area of the front beam; if the distance between the beams is equal to or more than the height of the beam, but less than its double height, the windward side shall be the total area of the front beam plus 50 per cent of the area of each subsequent beam; if the distance between the beams is equal to the double height of the beam or more, the windward side shall be the total area of all the beams. Portions of rear beams not covered by the front beam shall be fully allowed for in the calculations.

For tubular constructions the design windward side may be reduced by multiplying it by the correction factor 0,75.

The design windward area of the load is the actual area outlined by the contour of the load to be lifted by the crane.

For cranes with the safe working loads up to 10 inclusive, where appropriate data are not available, the load area may be assumed equal to 2 m<sup>2</sup> per 1 t for loads up to 2 t inclusive, and 1 m<sup>2</sup> per 1 t for loads of 10 t. The intermediate values of load area may be determined by interpolation.

**5.2.3** Stress calculations for structural members of the cranes shall be made for a heel 5° and a trim 2°. If the heel and trim in service are greater than those indicated above, actual values shall be used in the calculations.

**5.2.4** For derrick crane booms on rope suspension it shall be proved by calculations or a functional test that there is no risk of boom jack-knifing to the side opposite to boom outreach.

The jack-knifing is unlikely to occur if there is a positive tension in the boom ropes when the outreach of the boom is minimum and the inclination of the boom is the least that could occur in service (but not less than the heel of 5° and trim 2°), the wind pressure from the side of the outreach being as specified in 5.2.1.3.

## 5.3 METAL STRUCTURES

**5.3.1** The wall thickness of stress-bearing elements of crane or hoist metal structures which are readily accessible for inspection and maintenance as well as of the elements arranged in enclosed spaces shall not be less than 4 mm; the wall thickness of box-type or tubular metal structures inaccessible for inspection and maintenance from the inside shall not be less than 6 mm.

The maximum structural camber of the crane boom shall not exceed 1/1500 of its length, both in the plane of suspension and in the plane normal thereto.

**5.3.2** The outside diameter of tubular elements of metal structures shall not exceed the value indicated in 4.3.3.

**5.3.3** The construction liable to loads (especially to vibration loads) dangerous for breaking away rivet heads shall be avoided. In exceptional cases only, may such a construction be permitted. Tensile stresses in rivets with countersink or half-countersink heads are not allowed.

The holes for rivets and finished bolts shall be drilled in the joined items at one go or separately through jib plates.

The diameter of rivets and bolts used in the stress-bearing items shall not be less than 12 mm.

The maximum thickness of riveted items shall not exceed five diameters of the rivet.

The least number of rivets securing an item in the assembly or used on either side of the joint shall be not less than two.

## 5.4 MACHINERY

**5.4.1** The machinery of the cranes and hoists shall comply with the general technical requirements as specified in 1.5.

**5.4.2** The safety factor of braking for the hoisting machinery shall not be less than 1,5. For topping (luffing) machinery the safety factor of braking shall not be less than 2; the static moment on the braking shaft due to the weight of the load, weight of the jib and the counterbalance, shall be determined for such a position of the jib in which the moment is maximum.

In case the drive is fitted with two or more brakes, the safety factor of braking shall be specified, assuming that the entire load is held by one brake.

The safety factor of braking of each of the brakes shall not be less than 1,25 at simultaneous operation of all brakes. If operation of brakes is not simulta-



neous, the safety factors for individual brakes shall be used.

**5.4.3** Slewing and travelling motion brakes shall be of such design that they will either act automatically or be controlled; use of "normally on" brakes shall be subject to special consideration by the Register in each case.

The safety factor of braking shall not be less than 1,0.

The safety factor of braking for the upper structures of floating cranes (crane ships) and for the cranes intended for operation at rolling shall be not less than 1,5.

Hand-braked slewing and travelling motion machinery shall be provided with stops against uncontrolled slewing or movement of the cranes.

## 5.5 SAFETY DEVICES

**5.5.1** Cranes, derrick cranes and hoists shall be provided with limit switches that automatically come into action in the extreme positions of machinery for:

- .1 hoisting;
- .2 jib luffing;
- .3 travel of the crane, its crab and hoist;
- .4 slewing of the crane (for cranes with the limited slewing angle) or derrick cranes;
- .5 interlocking of the grab.

Provision shall be made for reverse movement the above items of machinery after the limit switches have been operated.

Where closing switches are provided for shunting the limit switches (e.g. for lowering a jib when the crane is being stowed for sea), they shall be accessible only for authorized crew personnel.

Installation of safety devices for derrick cranes rigged in union purchase is subject to special consideration by the Register.

On cranes where the jib, when lowering, superimposes on the cargo-gripping device, the hoisting machinery shall be switched off simultaneously with the topping machinery adjusted to jib lowering.

**5.5.2** On cranes where the safe working load varies with jib radii, an automatic indicator of safe working load at their appropriate radii shall be provided. The automatic safe working load indicator shall be fitted in full view of the crane operator.

To determine the permissible safe working load, the jib angle may be also indicated. In this case, a table or a diagram for re-calculating the values shown to obtain the permissible safe working load for the particular jib radii shall be fixed at the control station.

**5.5.3** The cranes, stability of which depends upon the load position on the hook shall be provided with

limit-load switches automatically disconnecting the crane machinery when an attempt is made to lift the load exceeding the safe working load of the crane for a given radius.

The limit-load switch shall operate if lifting of the load, which exceeds the safe working load by not less than 3 per cent and not more than 10 per cent. After operation the limit-load switch shall not prevent the load from being lowered.

It is recommended that limit load switches be fitted on cranes of other types and on hoists.

**5.5.4** Cranes with varying jib radii and constant safe working load over the whole radius shall be provided with limit-load switches of hoisting machinery.

**5.5.5** Cargo handling gear with the stationary control station or radio and telecontrol shall be provided with an audible warning alarm which can be put into operation by the driver at any time. The audible warning alarm shall be clearly heard and be distinctive among other audible signals and operation noises.

**5.5.6** Cranes operating in tandem and mounted on a common supporting and slewing bearing as well as those which operate in tandem, but are mounted separately, shall be fitted with automatic limiting switches to stop them in case of any mismatch in their operation or at least audible alarms shall be provided to warn the crane operator accordingly.

Such cranes shall be equipped with a control system enabling to control both cranes from any of them at the discretion of the operator.

When operating in tandem, both cranes shall be switched off upon operation of any of the limiting switches.

## 5.6 COUNTERBALANCES

**5.6.1** The design of the crane counterbalance shall ensure that the weight will remain stable while the crane is in use. Fastening of separate cargoes in the counterbalance shall prevent their displacement.

**5.6.2** The adjustable counterbalances shall either move automatically when the jib radii are being changed or be provided with a means for clear indication of the position of the counterbalance for different jib radii. In case of movement of the adjustable counterbalance, any possibility of its jamming shall be prevented.

## 5.7 MOBILE CRANES AND HOISTS

**5.7.1** Stability of the mobile cranes shall be ensured under all conditions, whether in service or

not. Stability shall be checked in accordance with procedures and standards approved by the Register.

**5.7.2** Mobile cranes shall be provided with devices for anchoring the crane to its rails or with reverse rollers.

**5.7.3** Mobile cranes and hoists shall be provided with efficient anti-creeping devices (detachable anchoring devices, etc.).

**5.7.4** Fastening of cranes and hoists when stowed for sea shall efficiently prevent their movement.

**5.7.5** Wheels of mobile cranes, trolleys and hoists shall be so designed or fitted that their derailment is prevented.

**5.7.6** Frames of mobile cranes and trolleys shall be provided with bearing struts arranged at a distance

of not more than 20 mm from the rails and may be used as supports in case a wheel or an axle is broken. The struts shall be calculated for the maximum permissible load.

**5.7.7** Mobile cranes, trolleys and power-driven hoists shall be provided with buffers to prevent their contact with stops. The buffers may be fitted on stops.

**5.7.8** Efficient stops shall be provided at both ends of the track, the design of which shall be such as to withstand the contact with the crane, trolley or hoist moving with the maximum working load at the nominal speed.

**5.7.9** If several cranes or trolleys travel at one railway, they shall be provided with the stops to prevent their collision.

## 6 UPPER STRUCTURES OF FLOATING CRANES AND CRANE SHIPS. CRANES ON FLOATING DOCKS

### 6.1 GENERAL

**6.1.1** The upper structures of the floating cranes, crane ships and cranes installed on floating docks are subject to all the requirements of the present Rules applied to the ship's cranes with due regard for additions and amendments specified in this Section.

**6.1.2** In case of inclinations permissible for the floating crane and crane ship in use, a counterbalance shall not extend outboard.

**6.1.3** The upper structures shall be provided with limit-load switches which comply with the requirements of 5.5.3.

### 6.2 CALCULATION

**6.2.1** The design loads for the upper structures shall be taken as follows:

**.1** load weight (the safe working load);

**.2** own weight of structures and equipment arranged thereupon;

**.3** wind load (wind pressure on the load and metal structures shall be taken not less than 400 Pa for maximum loads in the working condition, not less than 125 Pa for load drop and not less than 2000 Pa for the maximum load in the non-working condition. The design wind pressure in the non-working condition may be reduced if well-grounded reasons are given, allowing for actual conditions of service of the upper structures in the water area, but in all cases, however, it shall be assumed not less than 1000 Pa);

**.4** loads due to heel and trim of the ship (stress

calculation for structural members of the upper structures intended for operation in still water shall be made on the basis of static list  $5^\circ$ , with the slewing upper structure jib positioned transversely and on the basis of static trim, equal to  $2^\circ$ , with the jib alongside the ship; if the heel and trim are greater in service than those stated above, the actual values shall be taken for calculation; inertia forces acting on the upper structures as a result of rolling;

**.5** inertia forces resulting from hoisting (lowering) the load with the hoisting machinery, when operating in the acceleration (deceleration) mode (dynamic load factor shall be calculated by a method approved by the Register; in this case, its value for the upper structures intended for operation in still water shall be not less than 1,15, and not less than 1,4 for the upper structures intended for operation at rolling);

**.6** inertia forces arising from deceleration (acceleration) of jib luffing, slewing or travel machinery and loads resulting from rolling (calculated using angles of load deviation determined by a method approved by the Register; in all cases, the angles shall be assumed not less than  $3^\circ$  far and wide the derrick at a time). The angles shall be counted off from the vertical with maximum dynamic heel of the upper structure;

**.7** centrifugal inertia forces resulting from the upper structure turn;

**.8** vertical inertia forces acting on the load in case of rolling (considered by means of a dynamic load factor determined by a method approved by the Register; in all cases the value of the dynamic load factor shall not be less than 1,25).

**6.2.2** The following combinations of the design loads for the upper structures shall be considered:

**.1** normal loads in the working condition.

The loads to be included in the calculations are: the safe working load, own weight of constructions, inertia forces in case of smooth starting and braking, the average wind pressure. They are considered in calculation of endurance (fatigue strength) of the upper structure made by a method approved by the Register. Thus obtained, the value of safety factor shall be not less than that determined by the calculation given in 6.2.2.2;

**.2** maximum loads in the working condition.

*Case 1.* The upper structure is motionless (the hoisting machinery alone is working); hoisting (tearing off) of a load from the ground (deck) or braking in lowering the load, drop of load occur.

The loads to be included in the calculations are: the safe working load allowing for the maximum dynamic load factor, own weight of construction components and wind pressure on the crane structure and the load in the working condition, inertia loads resulted from the drop of the load and ship's motions in rolling.

The dynamic load factor shall be calculated with due regard for the maximum speed of load handling, rigidity of the structure (ropes included), and the structure and load masses both for hoisting (tearing off) and braking (when lowering) the load.

*Case 2.* The upper structure with the load is in motion (travelling, luffing or slewing), one of the items of machinery is in acceleration or deceleration mode.

The loads to be included in the calculations are: the safe working load and own weight of construction components with due allowance for the shock factor while moving along the track, maximum horizontal inertia forces of masses of the upper structure and the load, allowing for skidding of wheels, disconnection of limiting moment couplings or other design features, wind pressure on the upper structure and the load in the working condition and inertia forces resulting from rolling.

The shock factor is determined depending on the travelling speed and rail joints;

**.3** maximum load under non-working condition.

The loads to be included in the calculations are: own weight of construction components and wind pressure on the construction in the non-working condition.

In well-grounded cases, owing to specific features of service or the upper structure, use of the design loads different from the above may be required.

**6.2.3** For the upper structures of simple construction such as mast or mast-jib type, the design loads referred to in 5.2.1 may be used.

### 6.3 METAL STRUCTURES, DRUMS, BLOCKS

**6.3.1** The wall thickness of stress-bearing elements of metal structures shall be not less than:

5,0 mm for profiles painted from the inside and outside;

6,0 mm for closed box sections;

5,0 mm for hot-rolled or extruded tubes with hermetically closed ends.

**6.3.2** The thickness of the profile plate in welded structures shall be not less than 30 mm and not less than 50 mm in riveted and bolted structures.

**6.3.3** The ratio of the drum (block) and rope diameters shall be not less than:

16 for the drum;

18 for the working block;

14 for the balance block.

**6.3.4** The metal structures shall be so designed as to provide an access for their inspection from the inside. If such access cannot be provided, the requirements of 10.4.4 shall be met.

**6.3.5** Welded structures and joints of metal structure elements shall meet the requirements of 1.7, Part II "Hull", and Part XIV "Welding" of Rules for the Classification and Construction of Sea-Going Ships.

### 6.4 TESTS

**6.4.1** The upper structure of the prototype floating crane (crane ship) intended for the operation at rolling shall be subject to full-scale tests in the scope specified in 10.3.4, with maximum values of rolling and wind pressure.

**6.4.2** In addition to the tests to be carried out in accordance with 10.3.5, the upper structure of series-built floating cranes (crane ships) intended for operation at rolling shall be tested:

**.1** with a proof load equal to 1,4 of the safe working load with maximum radius of the jib along the ship. The proof load shall be applied statically. The time of keeping the upper structure under the load is at least 5 min;

**.2** with a proof load equal to 1,25 of the safe working load in the scope specified in 10.3.4.

## 7 SHIP'S LIFTS

### 7.1 GENERAL

**7.1.1** The requirements of this Section do not apply to the lifts with the safe working load less than 250 kg and to the lifts of special construction such as outboard lifts, as well as to the auxiliaries used for securing cargo (e.g. rigging screws, hooks, shoes on the rails, lighting gates, etc.) which are not an integral part of the lift.

**7.1.2** The lifts and their components shall be so designed, constructed and installed on board ships as to ensure their safe and efficient operation in full compliance with these Rules, recognized standards and specifications based on the above documents and approved in accordance with the established procedure.

**7.1.3** The ratio of drum, sheave or block diameter measured in the groove bottom to the rope diameter shall not be less than the values given in Table 7.1.3.

Table 7.1.3

| Type of lift | Drum or traction sheave | Angle blocks | Blocks of overspeed governors, gripping device operation, etc. |
|--------------|-------------------------|--------------|--|
| Passenger    | 40                      | 30           | 25   |
| Cargo        | 30                      | 25           | 25   |

**7.1.4** The lifts shall be provided with completely enclosed machinery spaces constructed to give weather protection and fitted with lockable doors.

The size of the machinery space shall ensure:

**.1** convenient access to the winch and motor from at least two sides with the width of a passageway not less than 500 mm;

**.2** the width of a passageway (in clear) from the front side of the control panels not less than 750 mm.

Where access is required from the rear of the panel for maintenance, the clearance between the panel and the wall shall be not less than 750 mm;

**.3** the free area of at least 1000x1000 mm at the entrance of the machinery space.

The height of the machinery space shall enable the mounting and dismantling of the equipment.

**7.1.5** Equipment which does not relate to the lifts may not be installed in the trunks and machinery spaces.

**7.1.6** The slots for passage of the cable made in the floor of the machinery and block spaces shall be of such size that the clearance between the cable and the slot edge will not be less than 25 mm. The slots shall be surrounded by kerbs at least 50 mm high.

**7.1.7** Each opening in a deck provided for a cargo lift platform shall be protected by barriers of a height of not less than 1 m above the deck level on each side of the opening that is not in use for vehicle access and egress.

The machinery of the cargo lift shall be interlocked unless the barriers are all closed.

**7.1.8** A suitable trip device shall be fitted beneath each side and end of the platform and beneath each side and end of each deck opening provided for the lift. Where locking latches are fitted at any deck to enable the platform to be stowed during cargo handling operations, they shall be interlocked in such a manner with the lift controls that the power cannot be applied to the platform until all the latches are withdrawn.

### 7.2 CALCULATION

#### 7.2.1 General.

Methods of calculation of forces and stresses in the lift components are not regulated by the Rules but in separate cases the Register may require that calculation methods approved by the Register are used.

#### 7.2.2 Design loads.

**7.2.2.1** In calculating the strength and stability of metal structures and loose gear, as well as the items of safety devices and guides the following shall be taken into account:

**.1** for the operating condition:

safe working load;

own mass of the equipment;

weight components for a ship having a heel of 15°;

weight components for a ship having a trim of 3°;

inertia forces due to ship's motion;

inertia forces exerted when the car (counterweight) is setting down on gripping devices and buffers;

**.2** for stowed condition:

own mass of equipment;

weight components for a ship having a heel of 30°;

weight components for a ship having a trim of 6°;

inertia forces due to ship's motions.

The design loads shall be considered for the most unfavourable operating condition of the structural member concerned.

**7.2.2.2** The useful car area for the passenger lifts is determined according to Table 7.2.2.2.

The maximum available car area, in m<sup>2</sup>, may be increased as follows:

Table 7.2.2.2

| Maximum number of passengers | Maximum car area, in m <sup>2</sup> , not more than | Maximum number of passengers | Maximum car area, in m <sup>2</sup> , not more than |
|------------------------------|---|------------------------------|---|
| 3                            | 0,70  | 12                           | 2,20  |
| 4                            | 0,90  | 13                           | 2,35  |
| 5                            | 1,10  | 14                           | 2,50  |
| 6                            | 1,30  | 15                           | 2,65  |
| 7                            | 1,45  | 16                           | 2,80  |
| 8                            | 1,60  | 17                           | 2,95  |
| 9                            | 1,75  | 18                           | 3,10  |
| 10                           | 1,90  | 19                           | 3,25  |
| 11                           | 2,05  | 20                           | 3,40  |

Note. The requirements of the Table do not apply to the lifts designed before 1982.

- 1,17 for 5 persons;
- 1,66 for 8 persons;
- 2,35 for 12 persons;
- 3,56 for 20 persons.

In calculating the safe working load of the lift the mass of one passenger is assumed to be 80 kg.

A decrease in useful car area may be taken into consideration as follows:

- where the handrails are installed, in proportion to the distance between the handrails and the car walls;
- where hinged doors are used, by the amount of the space occupied by one panel when it is open.

In calculating the loads it is assumed that the centre of gravity position of passengers and cargo in the car is as follows:

- for passenger lifts, at 1/6 of the width and 1/6 of the depth from the centre of the car floor;
- for cargo lifts, at 1/2 of the width and 1/2 of the depth.

The vertical centre of gravity position of cargo or passengers is assumed to be 1/2 of the car height counting from the floor.

Where the cargo is transported on trucks, the actual position of cargo in the lift car shall be taken into account.

**7.2.2.3** Inertia forces due to ship's motions taken into account in the calculation shall be not less than those determined by the following formulae:

rolling

$$P_y = aQ(0,061 \frac{\theta_{max}z}{T_1^2} + \sin \theta_{max}); \quad (7.2.2.3-1)$$

$$P'_z = kaQ(0,061 \frac{\theta_{max}y}{T_1^2} + \cos \theta_{max}). \quad (7.2.2.3-2)$$

pitching

$$P_x = aQ(0,061 \frac{\psi_{max}z}{T_2^2} + \sin \psi_{max}); \quad (7.2.2.3-3)$$

$$P''_z = kaQ(0,061 \frac{\psi_{max}x}{T_2^2} + \cos \psi_{max}), \quad (7.2.2.3-4)$$

where

- $P_x$  = component of the inertia forces, parallel to the longitudinal axis of the ship, kN;
- $P_y$  = component of the inertia forces, parallel to the transverse axis of the ship, kN;
- $P_z$  = component of the inertia forces, parallel to the vertical axis of the ship, kN;
- $P'_z$  = vertical component of the inertia forces due to rolling, kN;
- $P''_z$  = vertical component of the inertia forces due to pitching, kN;
- $a$  = 11,38, factor determined by multiplication of constant factor 1,16 by  $\frac{g}{g_0} = 9,81$  where  $g$  is the gravitational acceleration, m/s<sup>2</sup>;
- $Q$  = mass of structural member of lift and/or the allowable safe working load, t;
- $\theta_{max}, \psi_{max}$  = amplitudes of rolling and pitching, respectively, deg. The amplitudes for the operating condition of the lift shall be taken as maximum values at which the operation of the lift is still permitted and for stowed condition they shall be not less than 30° and 6° with a period of rolling and pitching 12 s and 7 s, respectively;
- $x, y, z$  = centre of gravity co-ordinates of lift structural members about the axes, with the ship centre of gravity being the origin of the co-ordinates, m;
- $T_1, T_2$  = periods of rolling and pitching, respectively, s;
- $k$  = dynamic load factor calculated with due regard for lift movement. The minimum values of factor  $k$  for main operating modes are given in Table 7.2.2.3-1.

Table 7.2.2.3-1

| No. | Operating mode of the lift                     | Dynamic load factor, $k$ |
|-----|--|--------------------------|
| 1   | Starting and stopping                          | 1,2                      |
| 2   | Setting down on buffer                         | 3,5                      |
| 3   | Setting down on abrupt braking gripping device | 3,5                      |
| 4   | Setting down on smooth braking gripping device | 3,0                      |
| 5   | Rolling of a truck in the car                  | 1,5                      |

The values of Table 7.2.2.3-2 for load components may be used having regard to a considerable effect of the lift position on the resultant components of load.

Table 7.2.2.3-2

| No. | Nos  | Load case resultant components of load, kN |       |       |
|-----|--|--|-------|-------|
|     |  | $P_x$                                      | $P_y$ | $P_z$ |
| 1   | Normal operation without ship inclination  | —  | —     | 11,8Q |
| 2   | Normal operation at an angle of heel 15° and an angle of trim of 3°                              | 1,1Q                                       | 3,2Q  | 16,4Q |
| 3   | Smooth braking gripping devices or buffers at an angle of heel of 15° and an angle of trim of 3° | 1,1Q                                       | 3,2Q  | 41,1Q |
| 4   | Instantaneous gripping devices at an angle of heel of 15° and an angle of trim of 3°             | 1,1Q                                       | 3,2Q  | 68,5Q |
| 5   | Stowed condition at an angle of heel of 30° and an angle of trim of 6°                           | 2,1Q                                       | 6,3Q  | 16,9Q |

Note. The resultant components allow for the loads due to inertia forces, heel and trim referred to in 7.2.2.1.

**7.2.2.4** Strength calculations of winches and their foundations are based on the values of rope pull

according to 7.2.3.2, taking into account losses due to friction forces, as well as the heel and trim of the ship. Dynamic load factor is determined by calculations or experimentally, but in no case shall it be less than 1,4.

**7.2.2.5** The design deceleration of an empty car or counterweight run, when setting down on buffers in an emergency at the rated speed, shall not exceed 25 m/s<sup>2</sup>. This value may be exceeded, if the deceleration time is not more than 0,04 s. The car buffers shall be so designed as to take up the kinetic energy of the car with the test load exceeding the safe working load of the lift by 10 per cent.

**7.2.3 Strength requirements.**

**7.2.3.1** The comparable stresses in structural members when subjected to the loads specified in 7.2.2.1 with regard to 7.2.2.3 shall not exceed the allowable stresses given below (see also 2.3.3 and 2.3.4).

| Operating conditions of the lift according to table 7.2.2.3-1 | Allowable comparable stresses, not more than |
|---|--|
| 1 . . . . .   | 0,40 $R_{eH}$                                |
| 2 . . . . .   | 0,60 $R_{eH}$                                |
| 3 . . . . .   | 0,70 $R_{eH}$                                |
| 4 . . . . .   | 0,80 $R_{eH}$                                |
| 5 . . . . .   | 0,60 $R_{eH}$                                |
| For winches and their foundations . . . . .                   | 0,60 $R_{eH}$                                |

Note.  $R_{eH}$  is upper yield stress of the material used.

In strength calculation of the parts made of cast iron, the safety factor shall be doubled relative to the allowable stresses.

**7.2.3.2** The safety factor of the suspension ropes with respect to their breaking load on the whole shall be not less than specified in Table 7.2.3.2.

Table 7.2.3.2

| Load imposed on the lift | Type of winch |          |
|--------------------------|---------------|----------|
|                          | Drum          | Traction |
| Passenger:               |               |          |
| static                   | 9             | 12       |
| dynamic                  | 6,5           | 8,5      |
| Cargo:                   |               |          |
| static                   | 8             | 10       |
| dynamic                  | 5,5           | 7,0      |

The safety factors of the suspension ropes specified in Table 7.2.3.2 are adopted as applied to the single rope run. The load  $S$ , in kN, imposed to one rope run is determined by the following formula:

$$S = \frac{Q + Q_c + Q_1 + 0,5Q_2}{100n} \quad (7.2.3.2)$$

where

- $Q$  = rated safe working load of the lift, kg;
- $Q_c$  = car mass, kg;

$Q_1$  = mass of ropes running from the drum, traction sheave or block to the point of their attachment to the car at its lowest level, kg;

$Q_2$  = mass of pulling arrangement of equalizing ropes, kg;  
 $n$  = number of ropes or rope runs by which the car is suspended.

For a rope used to operate the gripping device the ratio of breaking load to the maximum load calculated with regard to dynamics due to ship's motions shall be not less than 5.

**7.2.4 Requirements for rigidity and stability.**

**7.2.4.1** The rigidity of trunk structures to which the guides are attached shall be such that the total elastic deformation measured by the rod gauge (distance between the guides) will be not more than  $\pm 2$  mm when subjected to the rated loads specified in 7.2.2.1 with regard for 7.2.2.3 and 7.2.2.4.

The deflection of the guides under the same loads shall not exceed 0,001 of the distance between the supports of guide attachments to the trunk.

The deflection of the base girders carrying the winches under the same loads shall not exceed 0,0005 of the distance between the supports of the girders.

**7.2.4.2** The flexibility of the guides shall be not more than 120.

**7.3 METAL STRUCTURES**

**7.3.1 Trunk.**

**7.3.1.1** The lift trunk shall be provided with ceiling and bottom and be enclosed over the full height.

Ceiling, bottom and enclosure of the trunk shall be calculated in compliance with the requirements of 7.2 and shall meet the appropriate requirements of Part II "Hull", Part V "Subdivision" and Part VI "Fire Protection" of Rules for the Classification and Construction of Sea-Going Ships and Load Line Rules for Sea-Going Ships.

**7.3.1.2** The trunks shall not be located before the collision bulkhead and at a distance less than 0,2  $B$  from the ship's side.

**7.3.1.3** To ensure a means of escape from the lift trunk in case of an emergency stop of the car, a fixed ladder shall be provided in the trunk or clamps shall be fitted over the entire height of the trunk.

**7.3.1.4** At the bottom of the trunk provision shall be made for a pit, the shelter space of which counting from the base plate of the car or the counterweight to the buffer is not more than 200 mm when the car is at the lowest level. With the car resting on the fully compressed buffer, the distance from the pit bottom to the lower projecting parts of the car (except for shoes, lower beam and vertical panel under the sill) shall be not less than

750 mm. This distance may be reduced if there are removable devices to ensure the above distance when the car is setting down on them.

**7.3.1.5** The trunk pit may be drained using hand pumps, water ejectors or other drainage means, as well as through drain pipes led into the nearest compartments of the ship where drainage is provided.

The drain pipes shall be fitted with readily accessible self-closing cocks of not less than 39 mm in diameter.

**7.3.1.6** For maintenance of the equipment located in the lift trunk (angle blocks, overspeed governor, etc.) manholes with closing devices or removable plates may be provided in the ceiling and on the lift enclosure. Covers of the manholes and removable plates shall be opened outside.

**7.3.1.7** The inside surface of the trunk on the side of the car door shall be smooth and even, without recesses and projections.

This requirement shall be applied for the entire width of the door opening plus 50 mm on each side, and for the height, within the area of the door opening but not less than 300 mm for passenger lifts and not less than 200 mm for cargo lifts.

For other trunk areas limited by the width of the door opening plus 50 mm on each side recesses and projections of not more than 150 mm are permitted. For projections and recesses exceeding 5 mm (except for the lifts with power-operated doors) chamfers shall be provided at an angle of not less than 60° to the horizontal. For the lifts with power-operated doors chamfers shall be required for projections exceeding 50 mm and only from below.

**7.3.1.8** The height of the lift trunk shall be such that after operation of the limit switches and the lift stop:

**.1** free movement of the lift car (or the counterweight) upwards for a distance of not less than 200 mm is ensured;

**.2** the distance between the platform on the car roof designed for attending personnel and the projections of the trunk ceiling or the equipment under the ceiling is not less than 750 mm.

### **7.3.2 Trunk doors.**

**7.3.2.1** All entrance and loading openings in the trunk shall be provided with doors. The inner width of the door in clear shall be not more than that of the lift car. The hinged doors shall be opened outside only.

The height of the trunk door for passenger lifts shall be not less than 1800 mm, the minimum inner width of the door in clear being equal to 1600 mm. If loading and unloading operations are performed without entering the car, the height of the trunk door for cargo lifts shall not be more than 1400 mm. The height of the trunk door shall be measured from the deck to the upper edge of the door opening.

**7.3.2.2** The design and material of the doors if they are part of the tight structure shall comply with the requirements of Part III "Equipment, Arrangements and Outfit" and Part VI "Fire Protection" of Rules for the Classification and Construction of Sea-Going Ships.

**7.3.2.3** The doors shall be provided with sight openings. For lifts with power-operated doors and for lifts fitted with car landing indicators on the stop decks, sight openings may not be provided.

**7.3.2.4** Static compression force of the panels of semi-automatic trunk doors shall be not more than 150 N.

**7.3.2.5** The trunk doors shall be provided with locking devices to allow the doors to be locked before the car will move from its level for a distance of 150 mm.

**7.3.2.6** Manually-operated trunk doors, along with automatic locks, shall be fitted with non-automatic fixing devices allowing the doors to be closed with the locking devices unlocked.

**7.3.2.7** Measures shall be taken to prevent the lock from unlocking from outside the lift trunk if there is no car at the door level or if the movement of the lift car is controlled from the lift machinery space (see 7.10.3.5).

The exception is made for unlocking the trunk doors with no car at the door level by the authorized persons using special tools.

**7.3.2.8** If an obstacle arises for closing the power-operated doors, their panels shall take their initial position automatically.

### **7.3.3 Guides.**

**7.3.3.1** The lift car and its counterweight shall be provided with the guides of rigid and strong construction.

**7.3.3.2** The guides and their joints shall be so designed that their displacement in any direction is prevented.

**7.3.3.3** The length of the roller guides shall be such as to enable the lift car and counterweight to overtravel their limiting working positions with shoes not getting off from the guides (and with compressed buffers).

### **7.3.4 Lift car.**

**7.3.4.1** The lift car shall be provided with the floor and roof and be enclosed over the entire height.

**7.3.4.2** The car roof shall withstand without permanent deformation the load produced by two persons walking thereupon (the mass of one person is assumed to be 80 kg).

**7.3.4.3** Passenger lift cars shall be provided with doors. Cargo lift cars may have no doors to close the doways, provided the arrangements for cargo securing are available (see 7.1.1). The lattice type sliding doors are permitted for cars of cargo lifts only.

**7.3.4.4** The hinged doors shall be opened only inside the car.

**7.3.4.5** Static compression force of panels of power-operated sliding door shall be not more than 150 N.

**7.3.4.6** A lockable escape hatch of a size 400 x 500 mm (in clear) shall be provided in the roof of the passenger lift car. The car shall be fitted with the spar ladder or other means of access to the car roof in case of emergency. Instructions on leaving the car through the escape hatch shall be fixed inside the car. On agreement with the Register, the hatch size may be less for the lifts designed before 1982.

**7.3.4.7** The car of the passenger lift shall be provided with the handrails.

**7.3.4.8** The height of the car doors shall be not less than that of the trunk doors (see 7.3.2.1).

**7.3.4.9** The movable floor of the car shall be made as a solid board. The dimensions of the board shall be such that the width of the motionless part of the floor (frame) near the side and rear walls does not exceed 25 mm. The travel of the board shall not exceed 20 mm. In the car fitted with a movable floor, sliding doors and a control system which provides for the car movement only with the doors closed, the sill (the lower guides of the doors) is allowed to be motionless.

The safety switch shall operate safety contacts when the load imposed on the floor reaches 250 N.

The function of the movable floor may be substituted by an electronic load-measuring device positioned between the lift car and suspension ropes and ensuring the required switching-on process under the same minimum load.

**7.3.4.10** Under the car sill a vertical apron shall be provided over the whole width of the door flush with the front edge of the sill or movable floor.

The height of the apron shall be not less than 150 mm, and it shall be not less than 300 mm for power-operated trunk doors with the lift car being fully stopped.

**7.3.4.11** Manually opened car doors shall be provided with the sight openings.

#### 7.4 COUNTERWEIGHT

**7.4.1** Separate loads shall be so secured in the counterweight as to prevent shifting the loads from their normal position by more than 5 mm.

**7.4.2** Counterweight parts shall be reliably clamped by the hold-down straps and clamping bolts the nuts of which shall be secured by pins. Other suitable connecting means are allowed.

**7.4.3** A counterweight shall be fitted with guide shoes. If the counterweight is equipped with roller shoes, provision shall be made for hard control shoes.

**7.4.4** Lifts with a drum winch may not be provided with a counterweight.

#### 7.5 BUFFERS

**7.5.1** Buffers (limit stops) shall be located in the trunk pit under the lift car and counterweight.

**7.5.2** Lifts may be provided with spring or hydraulic type buffers ensuring deceleration of the car (counterweight) movement not exceeding  $25 \text{ m/s}^2$  when setting down on these buffers. This value may be exceeded if the deceleration time is not over 0,04 s.

Use of hard limit stops with flexible gaskets are allowed only for lifts having the rated speed not more than 0,7 m/s.

No hard limit stops with flexible gaskets are permitted for hospital lifts.

**7.5.3** Deceleration of the counterweight run when setting down on the buffer (limit stop) shall not cause setting of the car on gripping devices.

#### 7.6 GRIPPING DEVICES

**7.6.1** Lifts cars and counterweights shall be provided with gripping devices capable of gripping the guides and stopping the car (or counterweight) in the downward direction in case of:

.1 increase of the lowering speed to a value specified in 7.7.1;

.2 break of ropes.

**7.6.2** Gripping devices of passenger lifts shall be tripped by an overspeed governor. Tripping of gripping devices of cargo lifts is allowed only in case of break of the suspension ropes (without an overspeed governor) by connection gripping device mechanisms with

.1 suspension ropes;

.2 counterweight;

.3 gripping devices of the counterweight.

**7.6.3** The counterweight gripping devices may be tripped by one of the following methods:

.1 by overspeed governor when the limit speed specified in 7.7.1 is exceeded;

.2 by connection of mechanisms of gripping device operation with suspension ropes;

.3 by connection of mechanisms of gripping device operation with the car.

**7.6.4** The cars and counterweights of all types of lifts may be equipped with gripping devices provided for both abrupt and smooth braking. In this case, the maximum value of deceleration of the car or counterweight run when setting down on gripping devices shall not exceed  $25 \text{ m/s}^2$  (with no regard for ship's motions). This value may be exceeded if the deceleration time is not more than 0,04 s.

**7.6.5** The gripping devices shall be tripped only by means of mechanical devices.



**7.6.6** When tripped, the gripping devices shall automatically return to their working position as soon as the car (counterweight) starts lifting.

### 7.7 OVERSPEED GOVERNORS

**7.7.1** The gripping devices shall be tripped by overspeed governors at a speed of the car (counterweight) downward movement in excess of the rated speed within 15 to 40 per cent.

**7.7.2** The possibility of checking the trip of the overspeed governor and gripping devices during the car (counterweight) movement in the downward direction at the rated speed shall be provided. Where checking the overspeed governor tripping is impossible, other means shall be used.

**7.7.3** The force exerted in the working part of the rope by the overspeed governor, when tripped, shall be not less than twice the force necessary to engage the gripping devices.

### 7.8 ROPES, DETAILS OF CABLE RUN AND FASTENING OF ROPES

**7.8.1** The ropes for lifts shall be chosen according to calculations laid down in 7.6.2. In no case shall the rope diameter for passenger lifts be less than 8,0 mm for the suspension ropes and 6,0 mm for the ropes of the overspeed governors.

**7.8.2** The number of separate ropes by which the car and counterweight are suspended shall be not less than that given in Table 7.8.2.

Table 7.8.2

| Type of lift | Type of winch |          |
|--------------|---------------|----------|
|              | Drum          | Traction |
| Passenger    | 1             | 3        |
| Cargo        | 1             | 2        |

**7.8.3** Ropes shall be made of steel as one piece with the wires of "Lang" lay provided with a fibre or synthetic core. Ropes with a steel core may be used. In all other respects, the ropes shall meet the national standards and the requirements for ropes of the cargo handling gear (see 9.5.1, 9.5.2, 9.5.4).

**7.8.4** The proper strength of all parts of cable runs and attachment of ropes to the car, counterweight and winch drum (in case a drum winch is used) shall be provided. As to the blocks, thimbles, rope sockets, pressed clamps, the requirements of 9.3.4, 9.3.7, 10.2.1 and 10.2.4 shall be complied with.

### 7.9 WINCH

**7.9.1** Lift winches may be both of the traction (i.e. with a traction sheave) and of the drum type.

In both cases, a lift winch shall be equipped with a handwheel or other suitable means for manual operation with the maximum force not exceeding 735 N.

**7.9.2** All winches shall be fitted with self-locking brakes of the closedband type, the braking torque of which is equal to 1,5 times the rated load on the traction sheave or on the drum with the loaded car moving downwards. Use of band brakes is not permitted. When power supply from the electric motor is interrupted, the possibility of car movement by manual releasing of brakes shall be provided. The brake drum or the brake sheave shall be installed on the shaft which is kinematically non-detachable from the traction sheave (drum). When operation of the releasing element is interrupted, the brakes shall be tightened automatically.

**7.9.3** Interference fit is allowed in winch assemblies which transfer a torque (other than an electric motor) only provided they are additionally secured by keys, studs, bolts, etc. Additional fastenings shall be designed for the highest torque.

**7.9.4** When a rope is wound in a single layer onto the drum, the latter shall have helical rope grooves. Where the rope is wound in multi-layers onto the drum, the latter may be not grooved but in this case a suitable coiling device shall be fitted. Rims of the smooth (grooved) drums shall extend 2,5 rope diameters beyond the outer layer of the rope.

**7.9.5** When the car and counterweight are at their lowest position, at least 1,5 rope turns shall remain on the drum, besides those under the clamps.

The fasteners of ropes to the drum shall be designed with the rope friction to be neglected.

**7.9.6** The traction sheave shall be provided with grooves, the shape of which at a given angle of rope contact and with the selected material of the sheave would provide the required coupling of the ropes with the sheave. Structural measures shall be taken to provide stopping of the lift drive and to prevent the possibility of lifting the car in case of an emergency stop of the counterweight and vice versa. Dropping of ropes (chains) from driving and guiding components shall be prevented in all operating conditions of the lift.

### 7.10 ELECTRIC DRIVE, CONTROL, SIGNALLING AND LIGHTING

#### 7.10.1 General.

**7.10.1.1** Electrical equipment of the lift when not covered by specific requirements of these Rules shall

meet the appropriate requirements of Part XI "Electrical Equipment" of Rules for the Classification and Construction of Sea-Going Ships.

**7.10.1.2** Electric drive of the lift may be fed both from the main and the section switchboards or from the distribution board through a specially designed switching-off device (switch) fitted in the machinery space of the lift close to its entrance door.

This switch shall be so designed as to de-energize the driving motor simultaneously with the control circuits. Where driving motors for several lifts are installed in the machinery space, they shall be energized through separate switches.

**7.10.1.3** Provision shall be made for protection of the electric drive of the lift without time delay which ensures de-energizing of the electric motor in case of overloading and under short circuit current in the power circuit.

**7.10.1.4** Control circuits of the lift electric drive shall be provided with a switching-off device and short circuit protection.

**7.10.1.5** For all types of lifts provision shall be made for the electric motor switching-off, brake operation and car stoppage:

- .1 in any case of gripping device operation;
- .2 in case of breaking or slacking of one or more or all suspension ropes both on the car and on the counterweight side;
- .3 when the car exceeds its limit levels by more than 200 mm;
- .4 when rope pulling arrangement of the over-speed governor exceeds the limit operating positions;
- .5 when opening the car or trunk doors;
- .6 when unlocking the automatic lock of the trunk doors (except that where fixed rigid shifters are used).

**7.10.1.6** On unmovable parts of manually operated switches "on" and "off" positions shall be clearly marked.

**7.10.1.7** For earthing of the lift car, one of the cable cores or bus duct lead shall be used.

It is recommended that carrying cable ropes or suspension ropes of the car shall be used as an additional earthing lead.

**7.10.1.8** The metal guides of the car and counterweight, as well as the metal trunk enclosures shall be provided with reliable earthing connections with the ship's hull.

### **7.10.2 Electric drive.**

**7.10.2.1** The electric drive of the passenger lift shall provide smooth starting of the car, uniform increase of acceleration, smooth braking and deceleration of car movement when approaching the entrance station as well as precise stopping at the trunk doors.

In this case, the maximum acceleration (deceleration) of the car with the lift in operation (without regard for ship's motions) shall not exceed  $2 \text{ m/s}^2$ .

The maximum deceleration permitted with the car being stopped by means of the "safety" button (see 7.10.3.2) shall not exceed  $3 \text{ m/s}^2$ .

**7.10.2.2** The driving electric motor shall be switched on to the circuit by not less than two switch gears ensuring double break of the electrical motor supply circuit each time the car approaches the entrance station.

**7.10.2.3** The electric drive of the lifts with the rated speed of more than  $0,71 \text{ m/s}$  shall ensure the car movement at a speed of not more than  $0,35 \text{ m/s}$  (for the speed of car movement during inspection of the lift trunk, see also 7.10.3.5).

**7.10.2.4** Release of an electromagnetic brake shall be ensured simultaneously with switching on the driving motor, or immediately after its switching on. Switching off the driving motor shall be followed by operation of the electromagnetic brake or by switching on electrical braking with subsequent operation of the electromagnetic brake.

### **7.10.3 Control and signalling systems.**

**7.10.3.1** Control circuits of the electric drive shall be supplied by the power feeder of this drive. Connection to the feeder shall be made after the switching-off device.

**7.10.3.2** Lifts shall be controlled by special button units. All the control units, other than those intended only for calling the lift car on the loading deck, shall be fitted with safety buttons to ensure isolation of the electric drive from power supply. These buttons shall be painted red, bear clearly visible inscription "stop" and be placed nearby the control buttons.

**7.10.3.3** Control buttons of passenger lifts shall be placed inside the lift car and those of cargo lifts, on the loading decks.

**7.10.3.4** The interceptive call of the passenger lift car in the loaded condition using the control units placed on the loading decks is permitted only in case of simultaneous closing of the trunk and the car doors. In cargo lifts the interceptive call with the car moving in the loaded condition is not allowed.

**7.10.3.5** For inspection of the lift trunk and the equipment therein, the possibility shall be provided to control the electric drive system from the roof of the lift car by means of a fixed or portable control panel. In this case, the speed of car movement shall not exceed the speed specified in 7.10.2.3. The bottom unit shall be fitted with two control buttons for car movement (one for upward and the other for downward movement) with self-return to the "stop" position. For general control of electrical equipment operation a unit with pushbuttons "up", "down" and "stop" shall be provided in the lift machinery space.

The lifts with the rated speed of car movement  $0,70 \text{ m/s}$  and less shall be fitted for operation from

the car roof with control devices to ensure the car movement only in the downward direction where it is impossible to provide the speed not more than 0,35 m/s by means of the electric drive. When the electric drive is operated from the car roof or from the lift machinery space, if provided, all other control devices shall be interlocked or switched off automatically.

**7.10.3.6** Provision shall be made on the loading decks for a light signal (signal "loaded") to indicate the car loading (if the car is fitted with a relevant load control device), the car movement and the open position of the trunk door. The indicator may be mounted in the calling device or be placed adjacent thereto.

**7.10.3.7** The electric drive of the passenger lift shall be automatically isolated if an attempt is made to lift the load exceeding the safe working load of the lift car by 10 per cent. At the same time a visual or audible signal "overloaded" shall be operated.

**7.10.3.8** Passenger lifts shall be provided with alarms operated from the inside of the lift car in the event of failure of the lift (during an emergency stop of the car between decks, when setting down on gripping devices, etc.).

The alarm circuit shall be independent of the power and control circuits. Provision shall be made for feeding the alarms from the emergency source of power supply of the ship. The telephone or any other two-way voice communication may be used instead of alarms.

**7.10.3.9** A special spanner shall be used for operation of internal and external control switches placed outside the trunk and machinery space.

**7.10.3.10** The trunk pit shall be provided with an alarm automatically operating when the permissible level of water or other liquid in the pit is exceeded.

#### **7.10.4 Safety devices.**

**7.10.4.1** Limit switches of car movement upwards and downwards fitted in the control circuit, as well as door and gripping device contacts shall be of a self-return type and switch contact shall return to its initial position only after the forced action is stopped.

**7.10.4.2** All car and trunk doors shall be fitted with electrical contacts switched in the control circuit and meeting the following requirements:

**.1** starting and movement of the car shall be possible only when the trunk doors are closed and locked, and the car doors are closed. Starting and movement of the car with the trunk doors closed but not locked may be permitted for a distance of not

more than 150 mm from its stop level. Starting and movement of the car with the open doors may be permitted on condition that a device indicating that there is no passenger or cargo is provided;

**.2** opening of the car and trunk doors as well as unlocking of the automatic locking device of the trunk doors shall stop the moving car, except where the automatic locking devices are unlocked by means of a rigid (fixed) shifter;

When the door is opened, the door contacts shall interrupt the control circuit; working in closing the circuit is prohibited;

**.3** provision shall be made, in case of the multi-panel trunk or car doors, for control of the closure of each door panel.

**7.10.4.3** The limit switch of the main circuit may not be used as the main switch referred to in 7.10.1.2.

**7.10.4.4** Manual switches of control circuit shall be positioned in the lift pit and under the trunk ceiling where the angle blocks are placed.

**7.10.4.5** Electrical interlocking of the manhole cover on the car ceiling to prevent the car from movement with the open cover shall be provided.

#### **7.10.5 Lighting.**

**7.10.5.1** Lift car, trunk, pit, machinery space and means of access to the lift and its landing platforms shall be provided with stationary electrical lighting complying with the requirements of Section 6, Part XI "Electrical Equipment" of Rules for the Classification and Construction of Sea-Going Ships.

**7.10.5.2** Power supply of the lift car lighting circuit shall be provided by a separate feeder (from ship's lighting circuits) independent of the feeder of electric drive power supply.

**7.10.5.3** Provision shall be made for permanent switching of the car lighting circuit when the trunk doors are open or when the car of the passenger lift is loaded.

**7.10.5.4** Lighting fixtures shall be installed in the lift car in such a manner as not to be in the way of passengers and not to impede loading and unloading of the car. They shall not be damaged when loading and unloading the car.

**7.10.5.5** The socket outlets for portable lighting fixtures supplied by safe current shall be installed in the pit and machinery space.

**7.10.5.6** Cars of the passenger lifts shall be provided with stationary emergency lighting complying with the requirements of Section 9.4, Part XI "Electrical Equipment" of Rules for the Classification and Construction of Sea-Going Ships.

## 8 SHIP'S ELEVATING PLATFORMS

### 8.1 GENERAL

**8.1.1** The requirements of this Section apply to ship's elevating platforms with a safe working load of 1 ton and more and lifting and lowering speed not more than 0,1 m/s, intended for vertical loading/unloading of cargoes and vehicles.

**8.1.2** The design and location of ship's elevating platforms shall be such as to ensure their safe maintenance and inspection.

**8.1.3** The platforms designed for closing cargo openings in weather decks and unprotected superstructures shall be weathertight, having regard to the requirements of Section 7, Part III "Equipment, Arrangements and Outfit" of Rules for the Classification and Construction of Sea-Going Ships.

**8.1.4** It shall be ensured that the platform surface when the platform is moving up and down, as well as during cargo handling operations (considering the ship's inclinations given in Table 8.2.2.1) is always in the plane parallel to the serviced cargo decks.

**8.1.5** If one of the lifting mechanisms fails, the rest of them shall ensure (structurally and functionally) interaction between the platform and guides. In such emergency case, the driving units of the ship's elevating platform shall stop automatically.

With this in view, the platform shall be equipped with an emergency system for its controlled lowering in the locked or supported position enabling it to be safely unloaded.

**8.1.6** Where the platform is wire- or chain-operated, it shall be provided with at least four independent supporting appliances.

Each wire or chain suspension shall be fitted with a switch automatically stopping the drive in case of slacking or breaking of the supporting appliance.

**8.1.7** Wire ropes for the ship's elevating platforms may be used without an organic core. The rated breaking strength of wires shall be chosen as for running rigging.

**8.1.8** It is recommended that wire ropes for the ship's elevating platforms be subjected to pre-tension. The tensile load applied for not less than 30 min shall be equal to 0,7 of the minimum breaking strength of wire ropes.

**8.1.9** During installation on board the ends of the wire ropes of the ship's elevating platforms may be socketed in rope chucks. The rope connections shall be load tested according to 10.3.13.

**8.1.10** The design and control system of the ship's elevating platforms shall ensure that the platform

remains at the level of the cargo deck during cargo handling operations.

Where flexible supporting appliances are used (e.g. wire ropes) and the level cannot be automatically maintained by means of suitable equalizing devices, the platform shall be manually locked at the deck level before loading begins. Provision shall be made for visual indication of locking on the control panel. Lifting and lowering shall be possible only after the platform has been automatically or manually unlocked.

To prevent inadvertent operation it is recommended that the control system be automated, including use of computers.

**8.1.11** When stowed for sea, the platform shall be secured at the deck level and the drives shall be disengaged. A visual signal shall operate at the control stand. Ship's heel and trim shall not induce unlocking of the platform.

**8.1.12** The ship's elevating platform drive shall provide smooth starting of the platform, uniform acceleration, smooth deceleration and slowing down of the platform movement towards the end of its travel as well as accurate stopping at the required level.

**8.1.13** The ship's elevating platform drives located in the enclosed ship's spaces shall be designed with regard to the temperature range specified for these spaces.

**8.1.14** Hydraulic drives which provide reliable protection of the platform against self-lowering in an emergency need not be fitted with brakes.

**8.1.15** The control stands of the ship's elevating platforms shall be so arranged and provided with such devices as to enable the operator to observe the entire travel of the platform (directly or with the help of signalmen). In no case shall the control stand be positioned at a lesser distance than 1500 mm from the deck opening for the platform.

**8.1.16** Switchgear of the control stand of the ship's elevating platforms shall be provided with devices for self-return to zero position. Ship's inclinations shall not induce unintentional starting of the ship's elevating platform drives. Emergency switches shall be located as indicated in 1.5.7.16.

**8.1.17** Where an elevating platform is controlled from more than one control stand, provision shall be made for use of only one control panel and appropriate means of communication (e.g. telephone) shall be fitted.

**8.1.18** On agreement with the Register, the ship's elevating platform may be controlled from the platform.

**8.1.19** The control panels shall be provided with the following visual and audible signals:

- .1 actuation of any protection devices;
- .2 platform movement (flashing light);
- .3 open guards;
- .4 malfunction in an electric or hydraulic circuit.

At the discretion of the shipowner, other signals may be provided.

**8.1.20** All control panels shall be provided with suitable means to prevent them from use by unauthorized persons.

**8.1.21** All controls and signals shall be provided with clear inscriptions in the Russian and English languages made by indelible letters or other equivalent method.

**8.1.22** The ship's elevating platforms shall be provided with limit switches to secure the upper and lower levels of the platform and with an overload devices (automatic overload cut-out). Hydraulic drives shall be protected with safety valves, the working pressure of which shall not exceed 1,1 of the maximum design pressure.

**8.1.23** If the main lifting mechanism fails, the safety devices shall stop the platform automatically.

**8.1.24** Deck openings for the platforms shall be fitted with guard rails at least 1 m high. Movable railings shall be equipped with an automatic interlock controlled by the movement of the platform. Railings and guard rails shall be painted with a distinctive colour and shall be well lit.

**8.1.25** If persons involved in cargo handling operations are conveyed on the platform not only in the driver's cabin but also directly on the platform, provision shall be made at least on one of the longitudinal sides of the platform for removable guard rails and permanent marking containing an inscription to indicate areas intended for persons.

The guard rails shall be at least 1 m high; railing stanchions shall be spaced not more than 3 m apart. The intermediate rail shall be arranged at a height of not less than 0,5 m.

**8.1.26** Access of unauthorized persons to the space beneath the platform operated by a lever-pull system, spindles, etc. shall be prevented. Counterweights shall move in closed trunks. The danger areas due to the movement of the platform shall be suitably safeguarded with distinctive paint work and warning lamps.

cargo handling gear, particularly for cranes, set forth in Sections 2 and 5, shall be taken into account in strength and stability calculations for the ship's elevating platforms.

**8.2.1.2** Raising and lowering of the platform with a speed not exceeding 0,1 m/s shall be taken as a design condition only when in port. During unloading the platform shall be secured at the deck level.

**8.2.1.3** The allowable load on the ship's elevating platform shall correspond at least to the allowable load imposed on the deck area with which the ship's elevating platform shall be integral when stowed for sea.

**8.2.1.4** The calculations shall be made for the most unfavourable cargo arrangement.

**8.2.1.5** The platforms secured at the weather decks and unprotected superstructures to act as covers for cargo openings shall be designed according to the requirements of Section 7, Part III "Equipment, Arrangements and Outfit" of Rules for the Classification and Construction of Sea-Going Ships.

### **8.2.2 Design loads.**

**8.2.2.1** Design loads for ship's elevating platforms are given in Table 8.2.2.1.

**8.2.2.2** Apart from the loads given in Table 8.2.2.1, the platform shall be designed to withstand axial loads with the area of tyre traces produced by vehicles taken into account.

The relevant loads and their arrangement are given in 3.2, Part II "Hull" of Rules for the Classification and Construction of Sea-Going Ships.

### **8.2.3 Allowable stresses, safety factors and stability criterion.**

**8.2.3.1** The reduced stresses in metal structures and fixed gear of the ship's elevating platforms induced by the loads referred to in 8.2.2, shall not exceed the values given in Table 8.2.3.1.

**8.2.3.2** The safety factor of hoisting machinery (wire ropes, chains, etc.) subjected to breaking stress shall be not less than 5.

In case of loading 2.3 according to Table 8.2.2.1, the necessary strength factor relating to breaking may be taken by 50 per cent less than values required in normal cases.

**8.2.3.3** In stability calculations of ship's elevating platform components the requirements of 2.3.9 to 2.3.11 shall be met.

**8.2.3.4** Under normal loading conditions (see 1.1, 1.2, 2.1, 2.2, 3) according to Table 8.2.2.1, the platform deflections shall not exceed  $L/250$  (where  $L$  is either the length between supports or the length between unsupported parts of the platform). Deflections of the platforms which shall provide weathertightness when stowed for sea shall not exceed 0,0056 of a span.

## **8.2 CALCULATION**

### **8.2.1 General.**

**8.2.1.1** Unless expressly provided otherwise, appropriate general and special requirements for

Table 8.2.2.1

| Loading condition                                 | Case of loading | Operating condition  | Design loads   | Notes   |
|---|-----------------|--|--|---|
| Cargo handling operations (loading and unloading) | 1.1             | The platform is secured at the deck level                            | Weight of platform proper, cargo weight equal to the safe working load (unfavourable arrangement), static loads due to ship's inclinations (heel 5°, trim 2°), dynamic loads due to vehicles loading                             | The hoisting machinery is unloaded; safety systems do not transmit bending and moment and torque                                  |
|   | 1.2             | The platform is supported by the hoisting machinery                  | Similar to case of loading 1.1   | —   |
| Lifting and lowering                              | 2.1             | Reduced load   | Weight of the platform proper and cargo weight equal to the safe working load are distributed uniformly over the platform, static loads due to ship's inclinations (heel 5°, trim 2°), dynamic loads due to starting and braking | On agreement with the Register dynamic loads due to starting and braking need not be taken into account                           |
|   | 2.2             | Maximum operating load under the most unfavourable cargo arrangement | Weight of the platform proper, cargo weight equal to the safe working load, static loads due to ship's inclinations (heel 5°, trim 2°), dynamic loads due to starting and braking  |   |
|   | 2.3             | Failure of the hoisting machinery                                    | Weight of the platform proper, cargo weight equal to the safe working load, static loads due to ship's inclinations (heel 5°, trim 2°), dynamic loads due to hoisting machinery failure  | The rest of the hoisting machinery shall be so designed as to withstand additional loads and to be suitable for further operation |
| The platform is stowed for sea                    | 3               | The platform is locked with tight closing                            | Weight of the platform proper and cargo weight equal to the safe working load, forces due to lashings, inertial loads due to ship's motions  | See Note to case of loading 1.1   |

Table 8.2.3.1

| Loading condition than acc. to Table 8.2.2.1 | Allowable reduced stress, not more |              |
|--|------------------------------------|--------------|
|  | in members and components          | in plating   |
| 1.1  | $0,7R_{eH}$                        | $0,75R_{eH}$ |
| 1.2  | $0,7R_{eH}$                        | $0,75R_{eH}$ |
| 2.1  | $0,7R_{eH}$                        | $0,75R_{eH}$ |
| 2.2  | $0,8R_{eH}$                        | $0,85R_{eH}$ |
| 2.3  | $0,9R_{eH}$                        | $0,95R_{eH}$ |
| 3  | $0,7R_{eH}$                        | $0,75R_{eH}$ |

Note.  $R_{eH}$  — the upper yield stress of the material used.

## 9 GEAR AND ROPES

### 9.1 GENERAL

**9.1.1** Mating of the parts in movable joints shall provide proper fitting of the bearing surfaces with minimum radial and axial clearances permissible in service.

**9.1.2** Threaded connections of the parts shall meet the recognized standards.

### 9.2 FIXED GEAR

**9.2.1** Fixed gear shall be so attached to the metal framework as to ensure sufficient strength and adequate distribution of forces applied.

**9.2.2** The tubular mast shall be encompassed by the derrick heel bearing and the span eye plate by at least 40° counting from the axis of the bearing. For the step bearings the reach of compass in the lower part may be reduced but to not less than 30°. For the masts other than tubular ones the reach of compass shall be equivalent to their profile.

Where smaller angles of compass are used, the mast shall be reinforced by thicker walls or internal stiffeners.

**9.2.3** Eye plates for fastening a cargo block and a span as well as those for guy units and preventer guys shall be passed through the derrick head and be welded on both sides along the perimeter.

Eye plates for slewing guy units of the light-lift derricks may not be passed through the derrick head if they are welded both to the derrick and to cargo eye plate.

**9.2.4** Derrick heel fittings may be forged, cast or welded.

Derrick heel pins shall be provided with nuts and cotter pins; the stress-bearing portion of the pin thread shall take not more than 1/3 of the lug thickness.

**9.2.5** Goosenecks shall be safeguarded against slipping out of the bearings or step bearings.

**9.2.6** Lead block straps shall be made in one piece, except the check plates that may be welded on the strap.

**9.2.7** Derrick heel bearings may be either welded or cast. The gooseneck step bearing shall be provided with a drain hole.

**9.2.8** The span eye plate and the bearing may be forged, cast or welded. Eye plates of a shackle type shall be forged only.

The pin shall be secured against slipping out of the bearing and against turning in the bearing or eye plate of the shackle type.

It is recommended that a brass washer be placed under the bearing surface of the eye plate.

When the derrick is at the smallest angle to the horizontal, the force in the eye of the eye plate shall be directed across the pin axis in the upper half of the distance between the bearings.

**9.2.9** Eye plates for attachment of the standing rigging, slewing guy units, preventer guys, span chains, snatch blocks, etc., to the ship's hull and metal structures of the cargo handling gear, shall have such strength that will be adequate to their loads and be shaped so as to fit the gear items attached thereto.

Eye plates shall be fitted so that the maximum rigidity of the eye plates and the direction of the standing rigging ropes are in one plane; where the direction of the ropes is variable, the plane of the maximum rigidity of the eye plates shall correspond to the central direction of the rope.

The thickness of the plate with the welded-on eye shall be not less than 1/3 of the eye plate thickness and in all cases shall not be less than 5 mm. Stiffeners shall be generally positioned along the eye plate.

### 9.3 INTERCHANGEABLE COMPONENTS

**9.3.1** Cargo hooks and shackles shall be forged. Use of plate-like hooks and shackles shall be subject to special consideration by the Register in each case.

The hooks of ship's cranes and derricks used in cargo handling operations shall be so designed as to prevent any possibility of slipping off slings or catching the projected structures while lifting the load. Cargo hooks, shackles and their tackle shall not have any protruding parts and sharp edges.

For heavy-lift derricks and cranes with safe working load of 10 t and more, ramshorn hooks may be used, which shall meet the requirements for cargo hooks of standard design. On agreement with the Register, ramshorn hooks for floating cranes and cargo handling gear installed in the vessels of dredging fleet need not be specially designed for protection against slipping off slings or catching the projected structures.

**9.3.2** Swivels of cargo hooks and blocks shall be forged. The nut of the swivel shall be efficiently secured against turning on the thread.

**9.3.3** The shackles shall be forged, straight, with pins that are screwed into the eye plates or secured with nuts. Pins or nuts shall be adequately fixed.

Club shackles may be used as cargo shackles and also as shackles for the natural and synthetic fibre ropes.

Shackles for securing components in the cargo suspension system (hooks, counterweights, triangular bars and chains) shall have pins with half-counter-sunk heads without nuts.

The shackles shall be so arranged as to ensure the correct fitting of pins and to prevent twisting of the rope.

**9.3.4** Blocks shall be made so that the rope will not be jammed between the block cheek plates and the sheave.

Axles of sheaves shall be reliably stopped against turning and axial displacement.

Where bushed plain bearings are used, the block sheaves shall be provided with bushes made of anti-friction materials (e.g. bronze).

The eyes and lugs of the blocks shall be forged integral with the latter; nuts of swivels shall be securely stopped. Blocks with open hooks shall not be used in cargo handling gear.

Fastening of screwed forks with efficient stopping shall be specially considered by the Register in each case.

The diameter of sheaves for wire ropes measured in the bottom of the groove shall not be less than 14 times the rope diameter for the ropes movable under load, and at least 9 times the rope diameter for the ropes immovable under load.

The diameter of the sheaves intended for use with natural or synthetic fibre ropes shall not be less than 5 times the diameter of the rope.

The groove shall be so shaped as to accept the rope tightly and without jamming.

The diameter of the sheave and the shape of the groove shall be chosen on the basis of the diameter of the rope with the least design tensile strength of wires.

The depth of the sheaves grooves generally shall be equal to the rope diameter and in any case it shall be not less than 3/4 of the rope diameter.

The groove bottom shall have a circular contour forming a segment with an angle of at least 120°. The radius of the groove shall exceed the rope radius by at least 10 per cent.

**9.3.5** The triangular and multi-angular plates used for connection of ropes or chains shall be so thick as to suit the shackles secured thereto and to leave a minimum clearance enabling shackles to move easily; symmetrically welded reinforcing pads may be used.

**9.3.6** Forged eye ends and screwed forks shall be forged integral with the rigging screws; use of rigging screws with hooks is not allowed. The design of the rigging screws shall ensure the efficient stopping of tightened screws.

Fastening of screwed forks with efficient stopping shall be specially considered by the Register in each case.

**9.3.7** Thimbles shall be made of steel by smith forging or punching. Use of cast thimbles shall be specially considered by the Register in each case.

**9.3.8** Chains used in cargo handling gear, where not covered by the special requirements of these Rules, shall comply with the appropriate general requirements of 3.6, Part XIII "Materials" of Rules for the Classification and Construction of Sea-Going Ships.

Resistance welded chains or forged welded chains shall be used in cargo handling gear.

Short link chains with terminal links for attachment (pitched chains when used on sprocket wheels) shall be used as cargo chains.

Span chains and chains used with preventer guys in union purchase rig shall be long-link chains.

**9.3.9** Use of connecting links (of anchor chain link type) in cargo handling gear for fastening the ropes and chains to the metal structures and components shall be specially considered by the Register in each case.

Connecting links shall be forged. The joint design shall provide efficient connection of the both halves of link and efficient stopping to prevent their spontaneous disconnection.

The link installation shall provide their free movement in the holes of the components to be connected and prevent the link operation with cocking.

#### 9.4 LOOSE GEAR

**9.4.1** Loose gear (cargo-gripping devices) shall meet the requirements of 1.5, 5.3, 9.1 to 9.3 and 9.5.

**9.4.2** Having regard to a wind load and ship's inclinations, container spreaders shall be designed so that they can be placed in any position required to grip and place containers by changing a rope length of the cargo handling gear or using special guiding devices integral with the spreaders (e.g. turning device).

**9.4.3** Simultaneous engagement of twistlocks shall be structurally ensured.

**9.4.4** Provision shall be made for efficient securing of the extensible girders of telescopic spreaders in the appropriate operating positions.

**9.4.5** Centre of gravity correctors shall be efficient at least for the longitudinal axis of the container.

**9.4.6** Devices shall be provided to reduce swinging and to prevent uncontrollable turning of spreaders the suspension type of which does not prevent such motions.



**9.4.7** Efficient entering of twistlocks in the corner fittings of the container when mechanically operated shall be controlled by a contact sensor.

Twistlocks are engaged or disengaged by associated limit switches. Light indication of the twistlock position shall be provided on the control station of the cargo handling gear.

## 9.5 ROPES

**9.5.1** Ropes used in cargo handling gear, where not covered by the specific requirements of the present Rules, shall comply with the appropriate requirements of 3.15 and 6.6, Part XIII "Materials" of Rules for the Classification and Construction of Sea-Going Ships.

**9.5.2** For running rigging wire ropes with one organic core shall be used, the number of wires being not less than 114. Use of ropes with more than one organic core is subject to special consideration by the Register. It is recommended that ropes with the design tensile strength from 1275 to 1770 MPa with a diameter of wires in external strands of not less than 0,6 mm be used.

Ropes with steel cores may be used on agreement with the Register. In this case, the purpose for which the rope is intended and operation mode of the cargo-handling gear shall be taken into account. The relationship of sheave and drum diameters shall be as big as possible but not less than 18.

**9.5.3** For standing rigging steel wire ropes with a metal or organic cores may be used with a diameter of wires in external strands of not less than 1,0 mm, the number of wires being not less than 42.

It is recommended that ropes with a design tensile strength from 1275 to 1670 MPa (smaller values are preferable) be used.

**9.5.4** The wires of running and standing rigging shall be made of a continuous zinc-coated wire without knots and splices in accordance with recognized standards.

**9.5.5** Natural fibre ropes (manila, sisal, hemp) and synthetic fibre ropes may be used only for falls of the slewing guy tackles of light-lift derricks, inboard preventer guys or schooner guys in union purchase rig, and for handoperated cargo handling gear.

The diameter of the natural or synthetic fibre ropes shall be not less than 20 mm. The force at the fall running end pulled by hand shall be not more than 310 N.

Use of synthetic fibre ropes shall be subject to special consideration by the Register in each case.

## 10 EXAMINATIONS, INSPECTIONS AND TESTING

### 10.1 GENERAL

**10.1.1** Examinations, inspections and testing are carried out in order to ascertain that the cargo handling gear is in conformity with the requirements of the present Rules and is fit for safe use.

**10.1.2** The shipowner or the manufacturer has to submit the cargo handling gear for examinations and testing in the cases and at the intervals specified by the present Rules and to carry out all necessary preparations and tests.

**10.1.3** Examinations and supervision of tests of the cargo handling gear, their machinery and gear after they have been built, re-rigged or repaired shall be carried out by a Surveyor to the Register upon submission of the documents certifying the readiness for use and final acceptance by the manufacturer.

**10.1.4** When a cargo handling gear is examined by a Surveyor to the Register, the ship's Administration shall inform him of all the defects found as also of alterations made or repairs and replacement of parts and ropes that have been done since the previous examination.

**10.1.5** In case of an accident with the cargo handling gear in service, the ship's Administration or the shipowner shall provide for a timely examination of the cargo handling gear by a Surveyor to the Register.

**10.1.6** If examinations, inspections or testing reveals that the cargo handling gear, its metal structures, machinery and gear do not conform to the present Rules or are not fit for safe use, the Register documents will not be issued for the cargo handling gear or its elements; certificates for the cargo handling gear which are in service become invalid until the appliances are brought into conformity with the Rules or until the defects are eliminated.

**10.1.7** Certificates issued by the Register for the cargo handling gear become invalid in case the certificates on testing or thorough examination required by the Rules are not available or an entry on timely performance of periodical examinations has not been made or the cargo handling gear does not comply with its certificates or after an accident.

**10.1.8** For the initial survey of the cargo handling gear constructed under the rules of other classification societies, the shipowner shall submit the plans

and calculations as referred to in 1.4.6, and also the certificates issued by classification societies or by the manufacturer and certifying that the cargo handling gear has been tested and accepted for use.

Testing and examinations of cargo handling gear during the initial survey shall be carried out as specified in 10.3.

Where Certificates issued by other classification societies (see 11.1.4) on testing of interchangeable components and loose gear, and ropes are available, repeated testing will not be needed, provided the proof loads applied conform to the requirements of 10.2.1.

**10.1.9** Proof loads used in tests shall be specially intended for this purpose and have a mass confirmed by an appropriate document. The mass of cast ingots and as far as practicable of other loads shall be determined using a scales. If it is not possible, the mass shall be calculated.

#### 10.2 TESTING OF INTERCHANGEABLE COMPONENTS AND LOOSE GEAR

**10.2.1** All newly manufactured items of interchangeable components and loose gear of cargo handling gear shall be tested by a proof load as specified in Table 10.2.1 in the presence of a competent person.

Tests shall be carried out using an adequately calibrated machine or by suspending a load of a certain weight. The guaranteed accuracy of testing machines shall be within 2 per cent.

The proof load is applied statically, the period of the proof load application being not less than 5 min.

As far as practicable, all items shall be submitted for tests and examinations protected by anti-corrosive coating but not painted.

In case items of cargo handling gear have a very high *SWL* or a size which make use of testing

machines impracticable, tests shall be carried out by suspension of the items to an appropriate structure or a cargo handling gear and application of a proof load thereto.

**10.2.2** Several interchangeable components may be tested together, provided they are connected in a manner as they will operate under actual conditions. In this case, provision shall be made for application to each component of a proof load which corresponds to its *SWL*.

**10.2.3** After testing all components shall be thoroughly examined by a competent person to make sure that no defects or permanent deformations are left. Blocks shall be dismantled for inspection of axles and sheaves.

Upon satisfactory results of tests and examinations, a Certificate according to Form 5.1.4 shall be issued and an entry shall be made in Part II of the Register of Ship's Lifting Appliances and Cargo Handling Gear. If the tests have been supervised by a competent person, the Certificate according to Form 5.1.4 shall be issued by the Surveyor to the Register on the basis of the Certificate issued in accordance with 11.1.3 and signed by the competent person.

Stamping of the tested items of loose gear shall be carried out as described in 11.2.1.

**10.2.4** After load testing container spreaders shall be additionally subjected to functional tests depending on the operating conditions.

Lifting beams for heavy loads with a high cargo-carrying capacity relating to certain cargo handling gear are considered to be tested, provided they have been tested complete with the cargo handling gear.

**10.2.5** After repairs items shall be re-tested and re-examined by a competent person as specified in 10.2.1. The stamp shall be renewed after the repeated tests if it is not retained after repair.

**10.2.6** Tests of wire, natural and synthetic fibre ropes and chains shall be carried out in accordance with the requirements of 3.15, 6.6 and 7.1, Part XIII

Table 10.2.1

| Nos | Interchangeable components and loose gear                                      | Load corresponding to safe working load <i>SWL</i> , t | Proof load, t   |
|-----|--|--|---|
| 1   | Chains, swivels, shackles, hooks, etc.   | $SWL \leq 25$<br>$SWL > 25$                            | $2 \times SWL$<br>$(1,22 \times SWL) + 20$                      |
| 2   | Single-sheaved blocks with the inner end of the rope not attached to the block | $SWL$  | $4 \times SWL$  |
| 3   | Single-sheaved blocks with the inner end of the rope attached to the block     | $SWL$  | $6 \times SWL$  |
| 4   | Multi-sheaved blocks   | $SWL \leq 25$<br>$25 < SWL \leq 160$<br>$SWL > 160$    | $2 \times SWL$<br>$(0,933 \times SWL) + 27$<br>$1,1 \times SWL$ |
| 5   | Loose gear (slings, lifting beams, frames and container spreaders, etc.)       | $SWL \leq 10$<br>$10 < SWL \leq 160$<br>$SWL > 160$    | $2 \times SWL$<br>$(1,04 \times SWL) + 9,6$<br>$1,1 \times SWL$ |

"Materials" of Rules for the Classification and Construction of Sea-Going Ships.

Sockets and pressed clips used to restrain the ends of wire ropes and preventer guy thimble with pressed bushes shall be tested together with the ropes after socketing.

The tests shall be confirmed by a manufacturer's Certificate, and for chains and wire ropes with/without end sockets additionally by certificates according to Forms 5.1.4 and 5.1.5.

If tests have been supervised by a competent person, certificates according to Form 5.1.4 for chains and Form 5.1.5 for wire ropes are issued by a Surveyor to the Register on the basis of the Certificate signed by the competent person.

**10.2.7** Double hooks shall be tested by a proof load in accordance with Fig. 10.2.7. The tests may be conducted as one operation (Fig. 10.2.7(a)) or two operations (Fig. 10.2.7(b)).

**10.2.8** Forked blocks shall be tested by suspending a proof load as shown in Fig. 10.2.8(a) for single-sheaved blocks without a lug, in Fig. 10.2.8(b) for single-sheaved block with a lug, and in Fig. 10.2.8(c) for multiple blocks where  $n$  is the number of ropes.

**10.2.9** The prototype specimens of standardized interchangeable gear being as well as interchangeable components, the manufacture of which is being mastered at the manufacturer's, shall be tested by an ultimate load equal to a double proof load

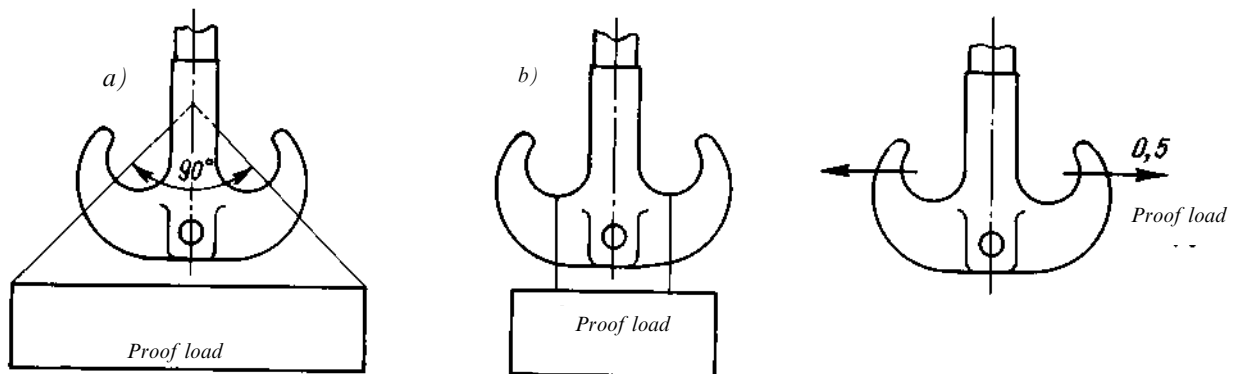

Fig. 10.2.7

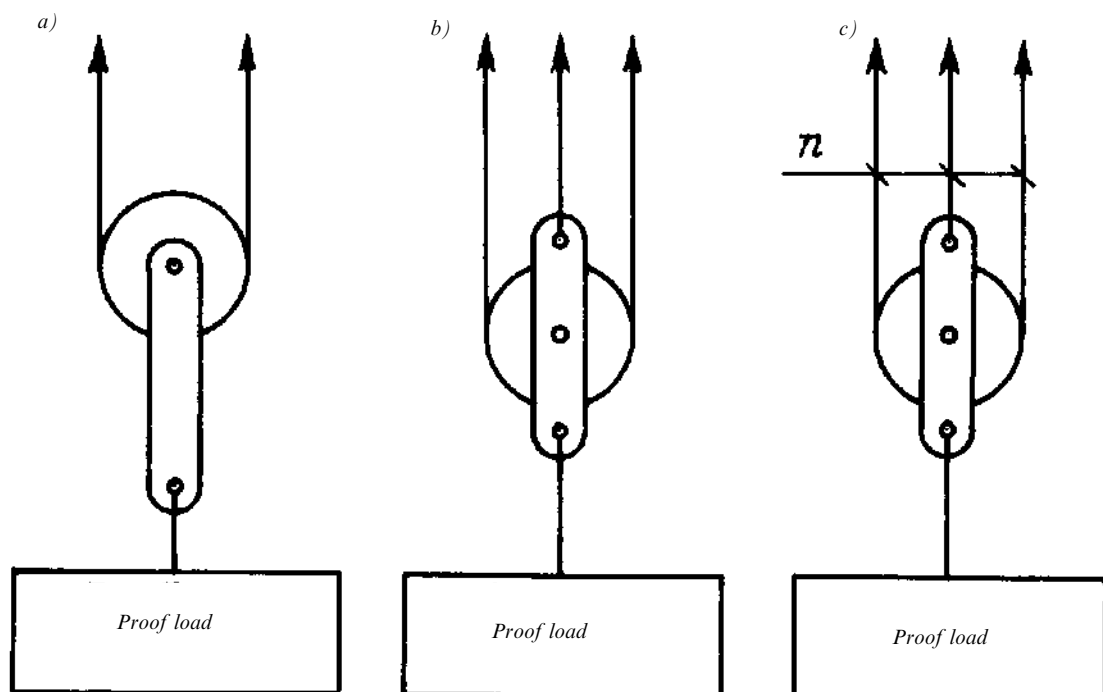

Fig. 10.2.8

referred to in 10.2.1; the Register may require that similar tests be carried out also for the prototype specimens of fixed gear. On agreement with the Register loose gear having a high safe working load (100 t and over) may not be tested by an ultimate load if their adequate strength is proved by calculations and results of proof load tests.

The Register may require periodical quality control of the manufactured interchangeable components by testing them with an ultimate load; the number of components out of the batch to be tested shall be agreed upon with the Register.

A component is considered as successfully tested if it remains unbroken after application of the ultimate load. If required by the Surveyor to the Register, the testing shall be continued until the component is broken.

The components tested with an ultimate load shall not be used in service or repaired.

Testing with an ultimate load shall be performed by the manufacturer in the mandatory presence of the Surveyor to the Register. The results of testing shall be shown in the manufacturer's Test Report and to be confirmed by the Surveyor to the Register.

**10.2.10** Own masses of prototypes or individual non-series products of loose gear shall be determined by weighing.

### 10.3 TESTING AND EXAMINATIONS OF MOUNTED CARGO HANDLING GEAR

**10.3.1** The assembled cranes, winches and reels shall be tested and examined by a competent person at the manufacturer's in accordance with the testing programme approved by the Register, using the proof loads given in Table 10.3.4

The tests and examinations shall be proved by the Certificate issued by the Register or by the manufacturer's Certificate signed by a competent person.

Marking and stamping of the tested cranes, winches and reels shall be done as specified in 11.2.

Gear and assemblies subject to loading shall be thermally insulated and painted after testing and examination.

**10.3.2** Prior to testing and examination of the cargo handling gear upon installation on board the ship, the following documents shall be presented to the Surveyor: appropriate certificates signed by a competent person; manufacturer's reports proving that the cargo handling gear is in conformity with the technical documentation approved by the Register, reports on quality control of works and quality of welded joints, certificates for materials and products, and heat treatment.

In case of structural alterations in cargo handling gear as a result of re-rigging or repairs, the scope of the technical documentation to be submitted shall be in accordance with structural alterations made.

For testing and inspection of cargo handling gear in service that have not been re-rigged, replaced or repaired, the scope of the technical documentation to be submitted shall be as specified in 11.1.

**10.3.3** Cargo handling gear shall be submitted for tests in the fixed-up state.

Prior to testing, they shall be thoroughly examined by a responsible representative of the manufacturer who has been involved in installation of the cargo handling gear on board or by another person who is responsible for performance of the tests. The cargo handling gear may be submitted for testing, provided no defects have been found during the examination that may affect the safety of the tests.

**10.3.4** Upon installation on board and prior to being taken into use, all cranes, hoists and derricks with their winches and all the accessories shall be tested with a proof load to be determined from Table 10.3.4 depending on the safe working load.

Table 10.3.4

| Safe working load <i>SWL</i> , t | Proof load        |
|----------------------------------|-------------------|
| Under 20                         | $1,25 \times SWL$ |
| 20 to 50                         | $SWL + 5 T$       |
| Over 50                          | $1,1 \times SWL$  |

The tests during the initial and periodical surveys shall be carried out with a proof load only. Between the periodical tests conducted after replacement or repair of any load bearing item and in case where a need in additional test arises (e.g. upon closing out the remarks and/or upon fulfilling the requirements set forward by the Surveyor after the proof load tests have been carried out), use of securely fixed spring or hydraulic dynamometers instead of proof load is allowed during periodic surveys, if specially agreed upon with the Register. The dynamometers may be used, provided that the rigging allows to subject the particular item to the same stresses (to be determined by calculation) as if the cargo handling gear had been tested by a proof load and the *SWL* of the cargo handling gear had not exceeded 15 t.

The dynamometers shall be calibrated with an accuracy within  $\pm 2$  per cent. During the tests their readings shall remain constant for at least five minutes.

Where, owing to pressure limitations, the hydraulically operated hoisting machinery fails to hoist the proof load as specified in Table 10.3.4, it is sufficient to hoist the greatest possible load at the

maximum permissible hydraulic pressure if the testing of the hoisting machinery with a proof load at the manufacturer's is proved by the Certificate. In this case, at the manufacturer's the assembled cranes may be tested with a proof load by suspension of a load on the hoisted hook by means of another cargo handling gear.

If the winch pull is not sufficient to hoist the proof load, the latter is allowed to be hoisted by another winch; however, braking and keeping the proof load in suspension shall be done by the winch to be tested.

If the rigging of the heavy-lift derrick includes the detachable stays and shrouds, these shall be fitted when the derrick is tested.

Collapsible derricks shall be tested with a proof load on every prop with which they are normally used.

Where stationary derricks are intended for operation at two hatches, they shall be tested in the operating position at each hatch separately. The derricks with two eye plates shall be tested with a proof load on each plate.

The proof load shall be hoisted with the derrick booms inclined at an angle of 15° to the horizontal for the light-lift derricks and 25° for the heavy-lift derricks; where the angles in service exceed the above values, the actual angles shall be used in tests.

Derrick cranes shall be tested with a proof load at the maximum angles allowable in service.

Inclination angles of derrick booms shall be stated in the Certificate, Form 5.1.2 (see also 11.2.12).

For derrick cranes and cranes with a variable jib radius and constant safe working load the proof load shall be hoisted at the maximum and minimum radii of the jib; where the safe working load of the crane varies with the jib radii, the proof load shall be hoisted at the maximum and minimum jib radii for each particular safe working load.

The crane jib radii shall be stated in the Certificate, Form 5.1.2. In case of a variable jib radius, the radius shall be also marked on the crane.

After the proof load has been hoisted, it shall be swung to the extreme positions in both directions by slewing the derrick or the crane and or by moving the crane (hoist, crab).

Operation of the brakes of the derrick and crane cargo winches shall be tested by quick lowering of the proof load for about 3 m and its sharp braking. The test shall be carried for at least two positions of the derrick.

Keeping the proof load in suspension with the winch drive disconnected as well as manual release of the brakes shall also be tested.

For heavy-lift derricks the derrick boom radius shall be varied under the proof load and functioning of the span winch brake shall be checked.

The test shall also include a functional check of the emergency switches and interlocking of the cargo winches, and span rope and preventer guys reels with an independent drive.

**10.3.5** After testing with a proof load, the cranes shall be tested with a load equal to the safe working load with the hoisting, slewing, luffing and travelling motion machinery operating in the maximum speed duty; the slewing, luffing and travelling motion brakes shall be tested by a sharp braking.

The limit switches and the jib radius indicators are also to be checked during the test.

If hoisting, luffing, slewing and travelling motions of the crane are combined, then operation of the crane shall be tested for each allowable combination.

If a crane is provided with limit-load switches, their functioning shall be tested by hoisting the ultimate load referred to in 5.5.3.

Derrick cranes shall be tested in a similar way.

**10.3.6** Where testing of a hoist located in the machinery space, shaft alley and other similar closed spaces is difficult owing to structural or technological reasons, on agreement with the Register it may be tested on a specially equipped bench outside these spaces.

Monorails shall be tested on board ship by means of a dynamometer with application of a proof load at different points along the monorail length. After mounting on board, operation of the hoist shall be checked without load.

Eyes for cargo handling operations in the above or other spaces shall be tested by a proof load equal to twice allowable working load for each eye plate. Dynamometer may be used for testing on agreement with the Register.

Upon satisfactory results of tests and examinations of ship derricks, ship cranes and hoists, a Certificate according to Form 5.1.2 shall be issued and an entry shall be made in Part I of the Register of Ship's Lifting Appliances and Cargo Handling Gear.

**10.3.7** The derricks rigged in union purchase shall be tested with a proof load, each derrick separately, as specified in 10.3.4. In addition, the derricks rigged in union purchase shall be tested with a load equal to 1,25 of the safe working load in union purchase.

During the test the proof load shall be transferred from one derrick head to the head of another derrick in the positions giving almost the ultimate included angle between the cargo runners.

If the derricks are rigged in different ways, those positions shall be subjected to testing that are likely to exert the greatest stresses in the preventer guys.

If the stress in one of the components of the union purchase rig (for example, axial thrust down the boom) exceeds the stress occurring in case of a single derrick rig (see 4.2.7), an additional test shall

be carried out with the booms in such a position that the component in question is tested under conditions similar to those assumed in calculations.

The positions of booms for testing the derricks rigged in union purchase shall be chosen on the basis of the calculation analysis; therefore, such selection shall be done in the course of design and be included in the testing programme.

During the test, means allowing to control the included angle between the cargo runners and the adjustment of derricks and preventer guys shall be checked.

After testing, all the equipment, machinery and gear of the derricks rigged in union purchase shall be submitted to the Register for thorough examination to ascertain the absence of defects or permanent deformations.

Upon satisfactory results of tests and examinations, a Certificate according to Form 5.1.3 shall be issued and an entry shall be made in Part I of the Register of Ship's Lifting Appliances and Cargo Handling Gear.

**10.3.8** The static tests of the ship's lifts shall be carried out to check the strength of the lift machinery, car, wire ropes and their attachments as well as operation of the brakes. For a lift fitted with a traction winch the lack of wire slipping in the grooves of the traction sheave shall be checked during the static test.

The following proof loads shall be applied during a static test:

$$P_{st} = 1,5P \text{ for cargo lifts with a drum winch;}$$

$$P_{st} = 2P \text{ for all types of passenger lifts and for cargo lifts with a traction winch}$$

where  $P$  is safe working load of the lift.

In the course of the static test the car shall be kept in the lowest operating position with the above load applied for at least 10 min.

The static test of the lift with a traction winch may be substituted by a thrice repeated downward movement of the laden car with a load exceeding the safe working load of the lift by 50 per cent.

**10.3.9** Dynamic tests shall be carried out to check the operation of the lift machinery, brake, gripping devices and buffers. The proof load applied for the dynamic test shall be equal to:

$$P_{dyn} = 1,1P$$

where  $P$  is safe working load of the lift.

When testing the gripping devices for smooth braking and hydraulic buffers, the effect of the winch brake shall be disregarded.

**10.3.10** The operation of winch, brake and buffers shall be checked at the rated speed. When buffers are tested, the switches of the upper and

ground floors shall be isolated. Testing of gripping devices and buffers shall be carried out with the brake released. If a spring failure or seizing of plunger occurs during the buffer testing, the test results are considered unsatisfactory.

**10.3.11** Testing of gripping devices tripped by the overspeed governors is carried out at the rated speed of the lift movement.

When gripping devices are not tripped by the overspeed governors, the car (counterweight) at its lowest level is placed on the support or suspended to the auxiliary rope. The suspension ropes are paid out after which the support is removed (the auxiliary rope is cut out). The way travelled by the car (counterweight) in free fall from the starting point to its landing on gripping devices shall not exceed 100 mm.

Gripping devices may be tested by another efficient method approved by the Register.

**10.3.12** After testing by a proof load the lift shall be functionally tested by a load equal to its safe working load. As this takes place, control and signalling systems, door contacts, limit switches and other safety devices are checked. The efficiency of lift operation shall be also checked during sea trials of the ship.

Upon satisfactory results of tests and examinations of the shift lifts, a Certificate according to Form 5.1.6 shall be issued and an entry shall be made in Part I of the Register of Ship's Lifting Appliances and Cargo Handling Gear.

**10.3.13** The ship's elevating platforms shall be statically tested with a proof load equal to 1,25 of the safe working load.

The dynamic tests of ship's elevating platforms shall be carried out with a proof load equal to 1,1 times the safe working load according to the applicable requirements of this Chapter.

**10.3.14** After testing with a proof load a ship's elevating platform shall be functionally tested by a load equal to its safe working load depending on the operating conditions.

The functional test shall include several full transport operations depending on the operating conditions (with trailers and tractors or similar vehicles loaded on the platform). Having regard to 8.2.3.4, platform deflections shall be measured and breaking of one of the supporting appliances. All safety devices, securing devices for hatchway covers and locking devices to hold the platform at the deck level shall be carefully checked. If the platform is not provided with locking devices at the level of working decks during cargo handling operations, the maximum clearance between the platform and deck shall not exceed 20 mm.

Upon satisfactory results of tests and examinations, a Certificate according to Form 5.1.2 shall be

issued and an entry shall be made in Part I of the Register of Ship's Lifting Appliances and Cargo Handling Gear.

**10.3.15** After testing the assembled cargo handling gear, its metal structures, machinery, equipment and safety devices, gear and ropes of the cargo handling gear shall be submitted to the Register for thorough examination to ascertain the absence of defects or permanent deformations.

If any defects are found in the process of the examination, that may endanger the safe use of the cargo handling appliance, the defective items or assemblies shall be either replaced or repaired and the test shall then be repeated.

Stamping of cargo handling gear after testing shall be done as described in 11.2.3.

#### 10.4 PERIODICAL SURVEYS, INSPECTIONS AND TESTS

**10.4.1** All derricks and gear (including span chain stoppers) permanently attached to derricks, masts and decks shall be inspected by the Surveyor the Register at least once every 12 months and be thoroughly surveyed by the Surveyor to the Register at least once every 5 years.

The results of inspections and surveys shall be entered in Part I of the Register of Ship's Lifting Appliances and Cargo Handling Gear.

**10.4.2** Ship cranes, hoists and derrick winches, derrick cranes shall be thoroughly surveyed by the Surveyor to the Register at least once every 12 months.

The survey results shall be entered in Part I of the Register of Ship's Lifting Appliances and Cargo Handling Gear.

**10.4.3** All interchangeable and loose gear shall be thoroughly examined by the Surveyor to the Register at least once every 12 months.

The results of examinations shall be entered in Part II of the Register of Ship's Lifting Appliances and Cargo Handling Gear.

**10.4.4** Periodical overall surveys and annual inspections shall be carried out to ascertain that certificates on testing cargo handling gear, interchangeable components and loose gear and ropes, appropriate marking and stamps, and entries about periodical heat treatment of interchangeable components are available, as well as to evaluate the condition of metal structures and their parts and assemblies, machinery and gear of the cargo handling gear.

If defects are found during a periodical survey that may endanger safe use of the cargo handling gear, or wear is found exceeding the allowable values,

the defective or worn-out parts shall be replaced or repaired and the defects eliminated.

Concealed spaces of metal structures inaccessible for examination shall be tested by air under excessive pressure 0,03 MPa with application of foaming solution. Other testing methods may be used if agreed upon with the Register.

The measurements of residual thickness of metal structures shall be carried out at least once every 5 years.

Occasional examinations and tests shall be carried out, if necessary, after repair or replacement as specified in 10.5.

**10.4.5** Periodical tests of the cargo handling gear mounted on board a ship shall be carried out at least once every 5 years in accordance with the appropriate requirements of 10.3.

Occasional tests conducted in accordance with 10.5 will be regarded as periodical tests.

The tests and associated examinations shall be confirmed by a Certificate issued on Form 5.1.2 (No. 2).

**10.4.6** Periodical surveys of cargo handling gear of ships not engaged in international voyages may be combined with annual surveys of the ship, having regard to the submissions before the assigned date and extensions permitted.

#### 10.5 OCCASIONAL EXAMINATIONS AND TESTS

**10.5.1** In case of placement, re-rigging or repair of the cargo handling gear, their machinery, metal structures or gear, the mounted cargo handling gear shall be examined and tested in accordance with appropriate requirements of 10.3.

Such examinations and tests shall, in particular, be carried out in the following cases:

- .1 after the replacement of the cargo handling gear as a whole or putting it in another place;
- .2 after the re-rigging of the cargo handling gear, major overhaul or repair after an accident;
- .3 after major overhaul, alterations or replacement of metal structures, machinery and fixed gear of the cargo handling gear;
- .4 if the height of the span rope fastening has been changed or fastenings of shrouds or stays have been shifted;
- .5 after replacement or major repair of a winch or a brake, after replacement of the car, counterweight, electric motor, suspension ropes, winch drum, after repair or replacement of the traction sheave;
- .6 after removal of a cargo handling gear because of certain reasons and its re-positioning in the original place.

After replacement of interchangeable components and loose gear and ropes, testing of the mounted cargo handling gear is not needed, however, they must have a Certificate according to Form 5.1.4 for gear and according to Form 5.1.5 for ropes.

After replacement of spreaders the cargo handling gear shall be subjected to operational tests with a suspended spreader and a container depending on the service conditions.

After replacement of cargo-gripping devices, overspeed governors or a buffer static tests of a ship's lift may be omitted.

In case of alterations in the wiring diagram or replacement of cables in the control circuit, as well as of modifications in the design of limit switches, door contacts, automatic locks, deck switches, centralized deck apparatus or any other devices performing the same functions, the static and dynamic tests of the ship's lift may be dispensed with. In such case, it is sufficient to run the tests in accordance with 10.3.12.

Occasional examinations and tests shall be confirmed by a Certificate according to Form 5.1.2.

**10.5.2** After accidents with the cargo handling gear which have taken place in the course of its service an occasional examination of the cargo handling gear shall be carried out to find out the technical reasons for the accident.

The extent of the examination required in that case shall be to the satisfaction of the Surveyor to the Register. The examination shall be carried out regardless of the validity of certificates for the cargo handling gear.

## 10.6 LIMITS OF WEAR

**10.6.1** The present standards of wear are tentative and may be altered depending on the specific operating conditions of a component and the type of wear. In order to determine more precisely the effect of wear on the strength and reliability of the component, calculation methods may be used.

The standards given below refer to places liable to the maximum wear.

**10.6.2** The components with 10 per cent wear and more regarding of thickness or diameter as well as the components with cracks, fractures or permanent deformations shall not be allowed for use.

When determining the wear of the articulated joints of derrick heel goosenecks and heel lugs, derrick span eye plate swivels, they shall be treated as plain bearings. The greatest diametral clearances shall comply with manufacturer standards.

**10.6.3** A wire rope shall not be used if:

**.1** 5 per cent and more of the total number of wires in the rope are broken in any length equal to 10 times the rope diameter;

**.2** there is any tendency towards birdcaging (i.e. separation of the strands or wires);

**.3** a strand is broken;

**.4** excessive wear is present which manifests itself by flat wire surfaces;

**.5** it shows signs of corrosion, particularly of the internal corrosion;

**.6** the wires are broken only in one strand, or in the length of less than 10 times the rope diameter, or in the wire hinges with metal clips;

**.7** more than one of the wires nearest to metal clips are broken.

**10.6.4** Natural and synthetic fibre ropes shall not be allowed for use in case of broken or rotten yarns, considerable wear or deformation.

**10.6.5** Metal masts, derricks, winch foundations, as well as metal structures of cranes and loose gear, having a residual thickness equal to 80 per cent and less of their initial thickness shall not be allowed for use.

**10.6.6** Wear of lift parts and assemblies shall not exceed the standards established by the manufacturer or by those given below.

**10.6.6.1** Wear of collars and seals is determined by the amount of oil leakage.

**10.6.6.2** The clearance between armature of the brake electromagnet and the yoke shall not exceed 4 mm.

**10.6.6.3** The clearance between the rope and the groove bottom shall be not less than 2 mm.

**10.6.6.4** The limits of uneven wear of grooves relative to each other shall be such as to allow the balancing suspension to compensate for the rope running without disconnection of the contact used to control shifting of the balance-beam lever.

**10.6.6.5** When wear of the grooves exceeds the above limits the sheave shall be grooved or renewed. Grooving of the sheaves is permitted only once.

**10.6.6.6** Wire ropes are considered to be defective depending on the number of wire breaks within the length of one step of a lay specified in Table 10.6.6-1.

The number of breaks in one step of a lay, at which the rope of the construction specified in Table 10.6.6-1 is considered to be defective, shall be determined on the basis of the data given in the table for the rope with the nearest number of strands and number of wires in the cross-section;

For example, the rope construction  $8 \times 19 = 152$  wires with one natural fibre core comes near to the rope  $6 \times 19 = 114$  wires with one natural fibre core. To determine the criterion for rejection, the number of breaks in one step of a lay given in Table 10.6.6-1 for the rope construction  $6 \times 19 = 114$  wires with one



Table 10.6.6-1  
Number of wire breaks within the length of one step  
of a lay at which the rope shall be rejected

| Initial safety factor<br>with Rules ratio $D/d$<br>(see 7.1.4) | Rope construction   |           |  |           |
|--|---|-----------|--|-----------|
|  | $6 \times 19 = 114$<br>and one natural<br>fibre core            |           | $6 \times 37 = 222$<br>and one natural<br>fibre core |           |
|  | Number of wire breaks within the length<br>of one step of a lay |           |  |           |
|  | cross   | one-sided | cross  | one-sided |
| less than 9  | 14  | 7         | 23   | 12        |
| 9, 10  | 16  | 8         | 26   | 13        |
| 11, 12   | 18  | 9         | 29   | 14        |
| 13, 14   | 20  | 10        | 32   | 16        |
| 15, 16   | 22  | 11        | 35   | 18        |
| over 16  | 24  | 12        | 38   | 19        |

Note. In calculating wire breaks the factors are assumed as follows: 1 for break of a thin wire; 1,7 for break of a thick wire.

natural fibre core shall be multiplied by factor  $96:72 = 1,33$  where 96 and 72 are numbers of wires in external strands of the former and the latter, respectively;

In case of wear of external strands of the rope or corrosion of wires, the number of wire breaks within the length of one step of a lay as a sign for rejection shall be reduced according to the data of Table 10.6.6-2.

Table 10.6.6-2  
Requirements for rope rejection relating to wear of external strands  
or corrosion of wires

| Wear of external strands<br>or corrosion of wires<br>according to rope<br>diameter, in per cent | Number of wire breaks within the<br>length of one step of a lay, in per cent,<br>relative to the values given<br>in Table 10.6.6-1 |
|---|--|
| 10  | 85   |
| 15  | 75   |
| 20  | 70   |
| 25  | 60   |
| 30 and over   | 50   |

If wear or corrosion of wires is 40 per cent or more of the initial diameter of wires, the rope shall be rejected.

Where the car is suspended on two ropes, each rope shall be rejected separately, substitution of more worn-out rope being permitted.

In case of wire breaks within the length of one step of a lay the number of which does not lead to rejection and in case of permissible wear of external strands, the rope is allowed for use subject to close supervision of its condition.

In case a broken strand is found in the rope, further use of the rope is not allowed.

The number of wire breaks within the length of one step of a lay of the overspeed governor is not exceed 20.

Where the car is suspended on three or more ropes, their rejection shall be based on the arithmetical mean which is determined proceeding from the maximum number of wire breaks within the length of one step of a lay.

In this case, the allowable number of wire breaks in one of the ropes may be exceeded but not more than by 50 per cent as compared to the values given in Table 10.6.6-1.

**10.6.6.7** Wear of shells of the car and counterweight shoes is allowed, provided the total side clearance between the wear surface of the guide and the shell is not more than 4 mm and the total face clearance measured by the rod gauge does not exceed 8 mm.

**10.6.6.8** The brake block coatings may be used as long as their thickness in the mid-portion and at the edges will not be reduced to 1/2 and 1/3 of their original thickness, respectively.

**10.6.6.9** Wear of worm-and-worm gear of the winch is checked by the value of play in worm gearing.

With the balanced suspension rope runs leading to the car and counterweight (or with the fully slackened ropes), as well as with the fully compressed brake blocks the worm is turned by the wheel to the left and to the right up to the perceptible stop. The idle running of the worm shall not exceed 1/10 of one complete revolution.

## 11 DOCUMENTATION AND MARKING

### 11.1 DOCUMENTS

**11.1.1** Ships and mobile offshore drilling units, cargo handling gear of which are subject to survey by the Register shall be provided (as required for the appliances installed) with the following documents:

.1 Register of Ship's Lifting Appliances and Cargo Handling Gear, Form 5.1.1 (No. 1);

.2 Certificate of Test and Thorough Examination of Lifting Appliances, Form 5.1.2 (No. 2);

.3 Certificate of Test and Thorough Examination of Derricks Used in Union Purchase, Form 5.1.3 (No. 2 (U));

.4 Certificate of Test and Thorough Examination of Interchangeable Components and Loosing Gear, Form 5.1.4 (No. 3);

.5 Certificate of Test and Thorough Examination of Wire Rope, Form 5.1.5 (No. 4);

.6 Certificate of Test and Thorough Examination of Lifts, Form 5.1.6;

.7 Manufacturer's Certificates for Natural Fibre and Synthetic Ropes;

.8 Instructions on Operation of Ship's Derricks and Cranes Used in Union Purchase.

**11.1.2** Entries in the Register and Certificates shall be made in Russian and for ships engaged in international voyages, also in English.

**11.1.3** Particulars of the tested item to be given in Form 5.1.4 (No. 3) shall contain a designation according to the standard or safe working load for non-standard parts, type of material and of heat treatment together with the following dimensions:

.1 for shackles — diameter of pin, and in case of an uncommonly sized jaw opening, also the clear jaw opening and the diameter of shackle in the middle of the bow;

.2 for swivel suspensions of blocks, swivels and turnbuckles — diameter of thread;

.3 for blocks — diameter measured in the bottom of sheave and axle diameter;

.4 for chains — gauge and type of link (short-link, long-link);

.5 connecting links — gauge of link and its length.

**11.1.4** Availability of valid certificates issued by other classification societies whose requirements are recognized by the Register as equivalent to the requirements of these Rules is sufficient to consider the cargo handling gear fit for safe use. If, however, there is any doubt as to the state of the cargo handling gear or its compliance with the certificates issued, the cargo handling gear may be subjected to a test or examination in accordance with these Rules, irrespective of the certificates available.

## 11.2 MARKING AND STAMPING

**11.2.1** Upon satisfactory results of testing with a proof load in accordance with 10.2 each interchangeable component and loose gear shall be marked and stamped. The marking shall contain the following particulars:

.1 load mass corresponding to the safe working load with indication of the letters SWL, t, in front of it;

.2 month and year of test;

.3 individual identification number of the item;

.4 stamp of the Register (if tested under the Register supervision) or manufacturer's stamp (if tested under supervision of a competent person);

.5 own mass, in t, with letters TW in front (for lifting beams, frames and spreaders);

.6 steel grade (see Table 11.2.1).

Table 11.2.1

| Steel marking | Grade of steel | Stress in a sample at the breaking load specified in ISO standard, $R_m^*$ , N/mm <sup>2</sup> |
|---------------|----------------|--|
| L             | Low-carbon     | 300  |
| M             | Higher tensile | 400  |
| P             | Alloyed        | 500  |
| S             | Alloyed        | 630  |
| T             | Alloyed        | 800  |

\* $R_m$  — tensile strength.

The stamps shall be positioned on items as follows:

h o o k s — on one of the side, on ramshorn hooks, on the wider portion between the horns;

s w i v e l s — on the wider side of the bow-piece close to the eye shank;

s h a c k l e s — on any side of the shackle close to the eye;

b l o c k s — on the strap or on the cheek plate (if there is no strap, between the eye and the sheave axle pin);

c r o s s — h e a d s of b l o c k s, in the middle of the side surface;

s w i v e l s of b l o c k s — on the side portion of casing close to the pin;

w i r e r o p e s o c k e t s, on the cone portion;

c h a i n s — on end link of each chain length;

c o n n e c t i n g l i n k s, on one side surface; identification number, on the centre insert on the lock;

r i g g i n g s c r e w s, on tubular body; identification number also on the eye or lug;

c a r g o - g r i p p i n g d e v i c e s, on clearly visible and protected place of load-carrying frame or beam near the support. Twistlocks of container spreaders shall be marked with their identification number.

Examples of marking are shown on Figs 11.2.1-1 to 11.2.1-5.

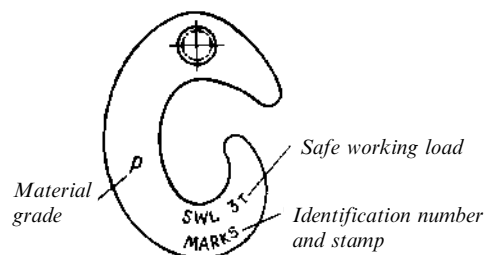

Fig. 11.2.1-1 Marking of hooks

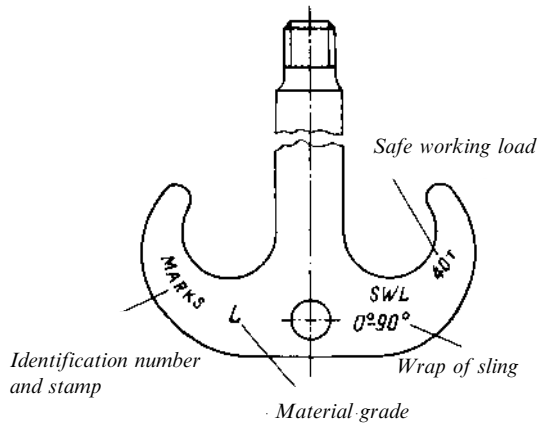

Fig. 11.2.1-2 Marking of ramshorn hooks

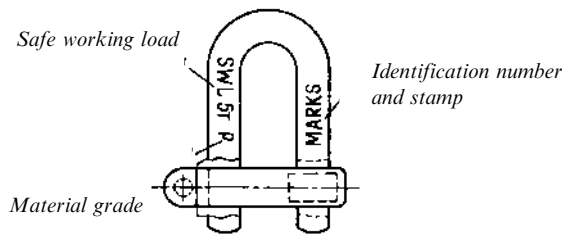

Fig. 11.2.1-3 Marking of shackles

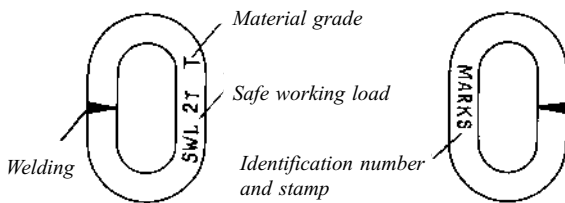

Fig. 11.2.1-4 Marking of chains

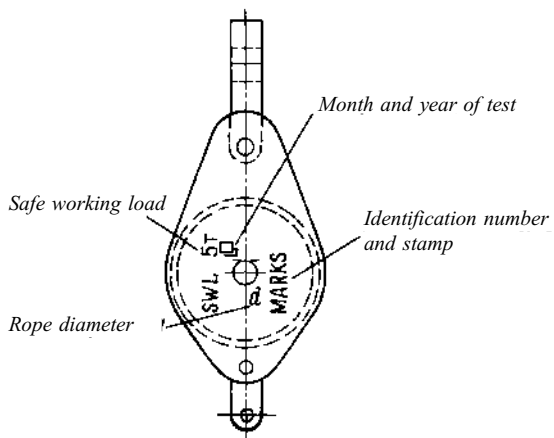

Fig. 11.2.1-5 Marking of blocks

Where small dimensions of items make stamping difficult, month and year of testing may be omitted.

**11.2.2** Upon satisfactory results of testing in accordance with 10.3.1, cranes, cargo winches, reels shall be marked. The marking shall contain the following particulars:

- .1 safe working load with indication of the letters SWL, t, in front of it (pull, tension in span rope, kN);
- .2 month and year of test;
- .3 individual identification number of the item;
- .4 stamp of the Register (if tested under the Register supervision) or manufacturer's stamp (if tested under supervision of a competent person).

**11.2.3** Upon satisfactory results of examination after testing each cargo handling gear tested with a proof load in accordance with 10.3.4 shall be marked and stamped. The marking shall contain the following particulars:

- .1 safe working load with indication of the letters SWL, t, for derricks also the minimum allowable inclination angle to the horizontal; for cranes and derrick cranes with a variable jib radius, the allowable maximum and minimum jib radii; where the safe working load varies with a jib radius, the marking shall contain the maximum and minimum jib radii for each appropriate safe working load; for passenger lifts, allowable number of passengers;

- .2 month and year of test;
- .3 identification number;

.4 stamp of the Register. The stamp shall be put on the derrick boom heel fitting and on the lower end of the crane jib close to the bearing. Ship's elevating platforms shall be marked near the hinged joints between the platform and supporting appliance. In all cases, the stamp shall be readily visible and easily accessible.

**11.2.4** Winches of lifts shall be provided with the plate containing manufacturer's name, type, rated traction force, manufacturer's number, date of manufacture and the Register stamp confirming acceptance of the winch.

**11.2.5** The gripping devices and overspeed governors shall be provided with the plate containing manufacturer's name, type, rated safe working load and speed for which they are designed, manufacturer's number and date of manufacture.

**11.2.6** Hydraulic buffers shall be provided with the plate containing manufacturer's name, type, rated speed for which they are designed, manufacturer's No. and date of manufacture.

**11.2.7** One of the suspension ropes shall be provided with the plate containing data of the rated diameter, construction, rated breaking strength, standard number, type and date of putting into operation.

**11.2.8** The marking shall be clear and durable and the places of marking shall be distinctively painted.

The stamp shall have round contour to avoid stress concentration and not be put on weld areas.

Where the material on which marking shall be put is too hard or marking on the item may affect safe operation, marking shall be put on a plate, disc, etc made of acceptable material and permanently fixed to the item.

**11.2.9** If the size of marking according to 11.2.3.1 is too big, information on intermediate values of the safe working load of the crane may be reduced on agreement with the Surveyor.

In such cases, for cranes the safe working load of which varies with a jib radius a metal plate containing jib radii for each appropriate safe working load shall be provided with a plate to be fitted in the cabin of a crane driver in a conspicuous and easily accessible position.

**11.2.10** On derricks and on metal structures of cranes the marking shall be punched or welded on. Ship's elevating platforms shall be provided with inscriptions on the platform or on the plates.

**11.2.11** Marking shall be made in Arabic figures at least 77 mm high, and marks for inclination of derricks at least 50 mm in height. Marking of the safe working load on lifting beams, girders, spreaders and othe similar devices shall be put in a conspicuous place; height of the letters shall allow operators to easily read them.

Where marking is put on directly on an interchangeable component, the height of the letter

for components shall not exceed the values given below for the following safe working loads:

- up to 2 t — 3,0 mm;
- from 2 to 8 t — 4,5 mm;
- more than — 6,0 mm.

When marking interchangeable components of round section, such as chains, etc., the height of the letters shall not exceed the values given below for the components with the following diameters:

- up to and including 12,5 mm — 3,0 mm;
- from 12,5 to 26 mm — 4,5 mm;
- more than 26 mm — 6,0 mm

The height of the letters of the marking put on plates, discs, etc. permanently fitted to an item may be reduced if necessary and/or if required by a competent person may exceed the above values.

Examples of marking are given in Table 11.2.11.

**11.2.12** Besides the hoisting particulars referred to in 11.2.3, every cargo derrick and crane shall be marked with its ship inventory number.

The order of numbering is as follows:

**.1** all light-lift derricks as well as derricks with the safe working load of 10 t and more positioned outside the ship's centre line, beginning from ahead starboard to port;

**.2** all heavy-lift derricks positioned in the ship's centre line beginning from ahead;

**.3** cranes, separately from derricks, beginning from ahead starboard to port.

Table 11.2.11

| Marking  | Signification  |
|--|--|
|  | <b>Derricks</b>  |
| <i>SWL</i> 1,5 t 15°                                   | Safe working load of derrick 1,5 t with derrick boom inclination of at least 15°   |
| <i>SWL</i> 5 t 30°                                     | Safe working load of derrick 5 t with derrick boom inclination of at least 30°   |
| <i>SWL</i> 3-5 t 15°                                   | With derrick boom inclination of at least 15°, safe working load of derrick 3 t for single-reeved runner and 5 t for double-reeved runner (tackle) |
| <i>SWL</i> 3 — 5 t 30°                                 | With derrick boom inclination of at least 30°, safe working load of derrick 3 t for single-reeved runner and 5 t for double-reeved runner (tackle) |
| <i>SWL</i> 3 — 5 t 10 t 15°                            | With derrick boom inclination of at least 15°, safe working load of derrick 3 t for single-reeved runner and 5 t for double-reeved runner (tackle) |
| <i>SWL</i> 20 t 25°                                    | With derrick boom inclination of at least 25° and special rigging of the derrick in accordance with design documentation, safe working load 10 t   |
| <i>SWL</i> 3 t 2 t 15°                                 | With derrick boom inclination of at least 25°, safe working load of derrick 20 t   |
| ∇  | Safe working load of derrick 3 t with derrick boom inclination of at least 15°   |
|  | Safe working load of derrick 2 t in union purchase as stated in the Instructions for Derricks Used in Union Purchase                               |
|  | <b>Cranes</b>  |
| <i>SWL</i> 3 t   | Safe working load of crane 3 t (for non-jib cranes, hoists and cranes with fixed jib radius)   |
| <i>SWL</i> 1,5 t 4 — 12 m                              | Safe working load of crane is 1,5 t with jib radii from 4 to 12 m  |
| <i>SWL</i> 3 t 4 — 12 m                                | Safe working load of crane 3 t with jib radii from 4 to 12 m   |
| <i>SWL</i> 5 t 4 — 6 m                                 | Safe working load of crane 5 t with jib radii from 4 to 6 m  |
| <i>SWL</i> 32/8 t — 22/24 m                            | Safe working load for the main hoisting machinery operation 32 t, it is 8 t for the auxiliary hoisting machinery operation                         |
|  | Maximum jib radius of the main hook is 22 m and that of the auxiliary hook 24 m  |
| <i>SWL</i> $\frac{100t}{32 t} \quad \frac{16 m}{24 m}$ | Safe working load is 100 t with jib radius 16 m and 32 t with jib radius 24 m  |

## 12 TECHNICAL SUPERVISION OF CARGO HANDLING GEAR IN USE

### 12.1 GENERAL

**12.1.1** Between surveys and examinations carried out by the Surveyor to the Register the responsibility for continuous supervision of keeping the cargo handling gear in conformity with certificates issued by the Register and with these Rules, the maintenance of the established limitations of the permissible safe working load, jib radii of cranes and inclination angles of derrick booms, control of adjustment of derricks and preventer guys and also of the angle between the cargo runners when in union purchase, and the keeping of the cargo handling gear in the state fit for safe use, rests with the ship's Administration.

### 12.2 PERIODICAL EXAMINATIONS OF INTERCHANGEABLE COMPONENTS AND LOOSE GEAR, AND ROPES BY SHIP'S ADMINISTRATION

**12.2.1** All interchangeable components and loose gear, and ropes shall be carefully examined at least once every three months by a responsible person assigned by the master. If defects are found out during such an examination. The results shall be entered in Part III of the Register of Ship's Lifting Appliances and Cargo Handling Gear.

Besides, interchangeable components and loose gear, and ropes shall be carefully examined by a responsible person every time before use of the cargo handling gear. In this case, an entry in Part III of the Register of Ship's Lifting Appliances and Cargo Handling Gear is made only if defects are found.

If broken wires are found in a rope, the rope shall be examined at least once a month.

### APPENDIX

## NOMENCLATURE OF MAIN STRUCTURES, MACHINERY AND GEAR OF CARGO HANDLING GEAR SUBJECT TO SURVEY BY THE REGISTER (TO 1.3.3 OF THE RULES)

### 1 SHIP'S DERRICKS

#### 1.1 Winches and reels:

cargo winches;  
span winches;  
guy winches;  
span reels;  
preventer guy reels.

#### 1.2 Metal structures:

cargo masts;  
short posts for mounting derrick heel fittings;  
cross trees;  
cross members;  
derrick booms;  
derrick boom supports;  
seats of winches and reels;  
stiffening of ship's structure in way of masts, winches and eye plates.

#### 1.3 Ropes and gear:

##### 1.3.1 Interchangeable components:

blocks;  
hooks;  
chains;  
shackles;  
swivels;

rigging screws;

thimbles, rope sockets, pressed clips of the ropes;  
triangular and polygonal plates;

derrick head eye fittings;

cross-head forks of blocks;

accessories of the cross members type, which are regular items of heavy lift-derricks (are subject to special consideration by the Register in each case);

stops for fastening preventer guys with pressed-on bushes.

##### 1.3.2 Fixed gear:

derrick head eye plates, span ropes, slewing and preventer guys;

eye plates secured on ship's hull, deck or metal structures;

derrick heel fittings;

span eye plates with bearings;

derrick heel goosenecks with bearings;

built-in sheaves of the booms with collars.

##### 1.3.3 Loose gear:

slings;

lifting beams;

frames;

container spreaders;

other similar gear.

**1.3.4 Ropes:**  
shrouds and stays;  
cargo runners, span ropes, tackles and slewing  
guy pendants;  
preventer guys and boom head guys in union purchase.

jib radius automatic indicators;  
limit-load switches;  
signalling devices;  
anti-stealing devices;  
safety buttons or switches.

## 2 CRANES AND HOISTS

**2.1 Machinery:**  
hoisting machinery;  
luffing machinery;  
slewing machinery;  
travelling motion machinery;  
brakes.

**2.2 Metal structures:**  
bridges;  
gantries;  
jibs;  
frames;  
foundations;  
stiffening of ship's hulls, pontoons and docks in  
way of cranes;  
fixed and turning columns;  
balance beams and rods of movable counter-  
weights;  
supports for derricks when stowed for sea.

**2.3 Ropes and gear:**

**2.3.1 Loose gear:**  
blocks;  
hooks;  
chains;  
shackles;  
swivels;  
thimbles, rope sockets and pressed clips of ropes;  
accessories of the cross members type, which are  
regular items of heavy cranes (are subject to special  
consideration by the Register in each case).

**2.3.2 Fixed gear:**  
eye plates;  
trunnions, axles with bearings;  
lead screws;  
rollers.

**2.3.3 Loose gear being part of the ship:**  
slings;  
lifting beams;  
frames;  
container spreaders;  
other similar gear.

**2.3.4 Ropes:**  
cargo runners;  
derrick ropes;  
grab ropes.

**2.4 Safety devices:**  
limit switches;

## 3 LIFTS

**3.1 Metal structures with loose gear:**  
trunks;  
guides;  
cabins;  
ceilings;  
foundations.

**3.2 Lift equipment:**  
trunk doors;  
counterweights;  
stops and buffers.

**3.3 Lift winches (of drum and traction type):**  
cargo shafts;  
couplings;  
base plate;  
brakes;  
drums.

**3.4 Safety devices:**  
gripping devices;  
overspeed governors;  
lowering and lifting limit switches.

**3.5 Ropes and items of cable run and fastening of  
ropes (sheaves, cleat casings, cleats, couplings, clips,  
hold-down straps, etc.)**

## 4 SHIP'S ELEVATING PLATFORMS

**4.1 Platforms**

**4.2 Platform equipment:**  
guides;  
shoes;  
blocking devices;  
buffers;  
locking devices;  
guard railings;  
drives (mechanical or hydraulic).

**4.3 Supporting appliances:**  
ropes with guides;  
chains with guides;  
fastenings;  
lever-pull system;  
hydraulic structural elements;  
gear racks;  
spindles.

**4.4 Safety devices.**

**5 ELECTRICAL EQUIPMENT  
OF CARGO HANDLING GEAR**

- 5.1** Electric motors.
- 5.2** Electric brakes.
- 5.3** Control stands.
- 5.4** Limit switches.
- 5.5** Safety buttons or switches.
- 5.6** Control device of load mass.
- 5.7** Cabling.
- 5.8** Other electrical equipment required for safe operation of cargo handling gear.

*Note.* The Nomenclature when applied to specific cargo handling gear, varies together with the design of the latter. However, the items listed in these Rules, as well as the stress-bearing essential elements of the cargo handling gear are subject to technical supervision in all cases.

All cargo handling gear, their machinery, metal structures, ropes and gear, as well as safety devices, as specified in the Nomenclature are subject to technical supervision of the Register regarding implementation of the Rule requirements for structure and calculations and, in case of technical supervision during manufacture and repair, also regarding the materials used, heat treatment, welding of the essential stress-bearing components in conformity with the specific requirements of these Rules and with the appropriate general requirements set forth in Part III "Equipment, Arrangements and Outfit", Part XIII "Materials" and Part XIV "Welding" of Rules for the Classification and Construction of Sea-Going Ships.

# **LOAD LINE RULES FOR SEA-GOING SHIPS**



# 1 GENERAL

## 1.1 SCOPE OF APPLICATION

### 1.1.1 Application.

1.1.1.1 The requirements of these Rules cover the following decked ships subject to the Register technical supervision:

.1 ships engaged in international voyages, with the exception of:

- new ships of less than 24 m in length;
- existing ships of less than 150 gross tonnage;
- pleasure yachts not engaged in trade;
- fishing vessels;

.2 ships of 24 m and over in length not engaged in international voyages with the exception of pleasure yachts not engaged in trade and fishing vessels;

.3 all types of new mobile offshore drilling units (MODU);

.4 ships of less than 24 m in length with the exception of pleasure yachts not engaged in trade.

1.1.1.2 The requirements contained in Sections 2 to 8 of the present Rules are applicable to new ships.

Existing ships not meeting all the requirements of the present Rules shall comply at least with the provisions of the Rules applied to these ships before coming into force of the present Rules. The freeboards of such ships are not required to be increased. However, to take advantage of any reduction in freeboard, as compared with that previously assigned, the existing ships shall comply with all the requirements of the present Rules.

1.1.1.3 The requirements contained in the Appendix are applicable both to new and existing ships to which the present Rules apply. A port standing on the boundary line between two zones or areas shall be considered as within the zone or area from or into which the ship arrives or departs.

1.1.1.4 The requirements contained in Sections 2 to 5 of the present Rules are worked out on the basis of the International Convention on Load Lines, 1966, as amended by Protocol 1988 revised in 2003<sup>1</sup>, and apply to ships specified in 1.1.1.1.1 the keels of which are laid or which are at similar stage of construction on or after 1 January 2005. Requirements of Section 3 shall apply to every ship to which a minimum freeboard is assigned. Deviations from these requirements may be granted to ships to which a greater than minimum freeboard is assigned on condition that the Register is satisfied with the safety conditions provided.

Where the ship is assigned an excessive freeboard such that the resulting draught is not more than that

corresponding to a minimum summer freeboard for the same ship, but with an assumed freeboard deck located a distance below the actual freeboard deck at least equal to the standard superstructure height, the requirements of 3.2.2 through 3.2.9, 3.2.12, 3.2.13 and 3.3 being applied, the actual freeboard deck may be considered as a superstructure deck.

1.1.1.5 The requirements contained in Section 6 of the present Rules apply to:

.1 ships specified in 1.1.1.1.2; the freeboards are assigned depending on the permitted area of navigation as for:

ships of unrestricted service and assimilated to them;

ships of restricted areas of navigation **R1**, **R2**, **R2-RSN** and **R3-RSN**;

ships of restricted area of navigation **R3**;

.2 ships engaged on international voyages solely in the Caspian Sea.

1.1.1.6 The requirements contained in Section 8 of the present Rules apply to ships specified in 1.1.1.1.4 operating in restricted areas of navigation **R1**, **R2** and **R3**.

MODUs shall be assigned freeboards in accordance with the requirements of Section 7 of the present Rules.

1.1.1.7 Ships with mechanical means of propulsion or lighters, barges and other ships without independent means of propulsion freeboards shall be assigned in accordance with the requirements of Sections 2, 3, 4, 8 and 6.1 to 6.4 of the present Rules.

1.1.1.8 Ships carrying timber deck cargoes may be assigned in addition to the freeboards prescribed in 1.1.1.7, timber freeboards in accordance with the requirements of Section 5 and 6.5 of the present Rules.

1.1.1.9 Ships designed to carry sail whether as the sole means of propulsion or as a supplementary means, and tugs, freeboards shall be assigned in accordance with the requirements of Sections 2, 3, 4, 6 and 8 of the present Rules. The necessity of increasing freeboards thus obtained and the amount thereof are subject to special consideration by the Register.

1.1.1.10 Ships of wood or composite construction, or of other materials the use of which the Register has approved, or ships whose constructional features are such as to render the application of the requirements of the present Rules unreasonable or impracticable, shall be assigned freeboards as determined by the Register in each case.

1.1.1.11 Cargo ships specified in 1.1.1.1.1 may be additionally assigned freeboards to operate within the restricted area of navigation in accordance with the provisions of Section 6. Cargo ships of unres-

<sup>1</sup> Hereinafter referred to as "the International Convention on Load Lines".

stricted service specified in 1.1.1.1.2 may be additionally assigned freeboards to operate within the restricted area of navigation **R1**. Cargo ships of restricted area of navigation, except for **R3**, specified in 1.1.1.1.2, as well as hopper dredgers and hopper barges irrespective of the area of their navigation without soil in hoppers may be additionally assigned the freeboard to operate within the restricted area of navigation **R3**.

#### **1.1.2 Exemptions.**

**1.1.2.1** Ships when engaged in international voyages between the near neighbouring ports of two or more states may be exempted by the Register from the requirements of the International Convention on Load Lines, so long as they shall remain engaged on such voyages, if the Governments of the States in which such ports are situated shall be satisfied that the sheltered nature or conditions of such voyages between such ports make it unreasonable or impracticable to apply the requirements of the mentioned Convention to ships engaged in such voyages.

Such a decision shall be drawn up as an agreement between Contracting Governments regarding service conditions of particular ships or as a regional agreement on load line for all ships flying the flags of these states.

**1.1.2.2** The Register may exempt any ship which embodies constructional features of a novel kind from any of the provisions of the International Convention on Load Lines, and the present Rules the application of which might seriously impede research into the development of such features and their incorporation in ships. Any such ship shall, however, comply with safety requirements, which, are adequate for the service for which it is intended. These requirements shall also be acceptable to the Governments of the States to be visited by the ship.

**1.1.2.3** A ship which is normally not engaged in international voyages but which, in exceptional circumstances, is required to undertake a single international voyage may be exempted from any of the requirements of the International Convention on Load Lines, provided that it complies with safety requirements which, in the opinion of the Register, are adequate for the voyage which shall be undertaken by the ship.

**1.1.2.4** A ship of restricted area of navigation **R1**, **R2**, **R2-RSN**, **R3-RSN** or **R3**, which in exceptional circumstances is required to undertake a single voyage outside the limits of the area of navigation permitted, may be exempted by the Register from any of the requirements of the present Rules, provided that it complies with safety requirements which, in the opinion of the Register, are adequate for the voyage which shall be undertaken by the ship.

#### **1.1.3 Equivalents.**

The Register may allow any fitting, materials, appliances or apparatus to be fitted, or any other provision to be made in a ship, other than that required by the International Convention on Load Lines, and the present Rules, if it is satisfied by trial thereof or otherwise that such fitting, materials, appliances or apparatus, or provisions are at least as effective as that required by the Convention and the present Rules.

#### **1.1.4 Approvals for experimental purposes.**

Nothing in the present Rules shall prevent the Register from making specific approvals for experimental purposes in respect of a ship to which the present Rules apply.

#### **1.1.5 Communication of information to Governments concerned.**

When any exemptions are granted under 1.1.2.1 and 1.1.2.2 or any equivalents are allowed under 1.1.3 or any approvals for experimental purposes are made under 1.1.4 for ships specified in 1.1.1.1.1, the Maritime Administration of the Russian Federation upon presentation by the Register shall communicate to the International Maritime Organization (IMO) particulars of the exemptions and reasons therefore, data on the equivalents together with a report on trials made and data on measures approved for experimental purposes which the Organization will circulate to the Governments of the States that have accepted the International Convention on Load Lines.

#### **1.1.6 Repair, alterations and modification.**

**1.1.6.1** A ship which undergoes repair, alterations, modification shall continue to comply with at least the requirements previously applicable to the ship. An existing ship, in such a case, shall not, as a rule, comply to a lesser extent with the requirements for a new ship than it did before.

**1.1.6.2** A ship which undergoes repair, alterations and modification of a major character and outfitting related thereto shall meet the requirements for a new ship in so far as is deemed reasonable and practicable.

## **1.2 DEFINITIONS AND EXPLANATIONS**

**1.2.1** The definitions and explanations concerning general terminology of the Rules are given in Part I "Classification" of Rules for the Classification and Construction of Sea-Going Ships.

For the purpose of the present Rules, the following definitions have been adopted.

A *forecastle* is a superstructure which extends from ship's bow or, as a minimum, from

forward perpendicular aft to a point which is forward of the after perpendicular.

**Watertight** means capable of preventing the passage of water through the structure in either direction with a proper margin of resistance under the pressure due to the maximum head of water which it might have to sustain.

**A raised quarter deck** is a superstructure which extends, as a minimum, forward from the after perpendicular, generally has a height less than a normal superstructure, and has an intact front bulkhead (sidescuttles of the non-opening type fitted with efficient deadlights and bolted man hole covers). Where the forward bulkhead is not intact due to doors and access openings, the superstructure then shall be considered as a poop.

**Height of superstructure** is the least vertical height measured at side from the top of the superstructure deck beams to the top of the freeboard deck beams.

**A flush deck ship** is a ship which has no superstructure on the freeboard deck.

**A hopper barge** is a cargo transport ship intended only for transportation of spoil.

**Length of superstructure  $S$**  is the mean length of that part of the superstructure which lies within the length of the ship  $L$ .

**Length of ship  $L$**  is taken as 96 per cent of the total length on a waterline at 85 per cent of the least moulded depth, or as the length from the fore side of the stem to the axis of the rudder stock on that waterline, if that be greater.

Where the stem contour is concave above the waterline, the length of the ship shall be measured from the vertical projection to that waterline of the aftermost point of the stem contour (above that waterline) (Fig. 1.2-1).

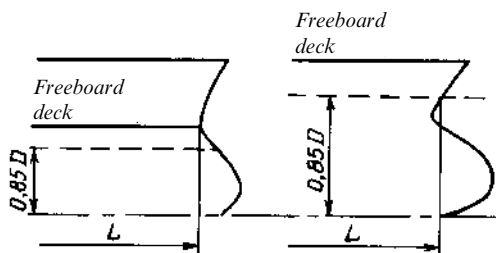

Fig. 1.2-1

A ship which is composed of a series of successively and permanently attached rigid sections shall have a length determined by the overall length of the series. A propulsion section shall be included in the total length if it is rigidly attached, otherwise it shall be treated as a separate ship.

In ships designed with a rake of keel, the least moulded depth is measured vertically at the point where the freeboard deck sheer curve line is tangential to a straight line drawn parallel to the keel line. The waterline on which the length of the ship is measured shall be parallel to the designed waterline.

**Anniversary date** means the day and the month of each year, which corresponds to the date of expiry of the relevant Certificate.

**An enclosed superstructure** is a superstructure with enclosing bulkheads of adequate strength; access openings, if any, in these bulkheads fitted with doors complying with the requirements of 3.2.2; all other openings in sides or ends bulkheads of the superstructures fitted with efficient weathertight means of closing.

**A decked enclosed ship** is a ship having over the entire length a deck, openings on the open portions of which have permanent weathertight means of closing and below which openings in sides are fitted with permanent means of watertight closing.

**A well** is any area on the deck exposed to the weather, where water may be entrapped.

**Block coefficient  $C_b$**  is a coefficient determined by the formula

$$C_b = \frac{\nabla}{LBd_1}$$

where  $\nabla$  = the volume of the moulded displacement of the ship, excluding bossing, in a ship with a metal shell, and is the volume of displacement to the outer surface of the hull, excluding bossing, in a ship with a shell of any other material, both taken at a moulded draught of  $d_1$ , m<sup>3</sup>;

$d_1$  = 85 per cent of the least moulded depth, m.

**Note.** Conventional nature of  $L$  definition can result in  $C_b$  values exceeding 1, e.g. for the pontoon type ships. In this case  $C_b = 1$  is assumed.

In calculations of  $C_b$  for multi-hull ships the breadth of the whole ship but not of one hull shall be taken into account.

**International voyage** is a sea voyage from a country to which the International Convention on Load Lines, applies to a port outside such country, or conversely.

**Amidships** is the transverse section at the middle of ship's length  $L$ .

**Freeboard** is the distance measured vertically downwards amidships from the upper edge of the deck line to the upper edge of the related load line.

**Superstructure** is a decked structure on the freeboard deck, extending from side to side of the ship or with the side plating not being inboard of the shell plating more than 4 per cent of the breadth  $B$ .

A raised quarter deck is regarded as a superstructure.

A bridge or poop shall not be regarded as enclosed unless access is provided for the crew to

reach machinery or other working spaces inside superstructures from any point of the uppermost exposed deck or higher than that by alternative means which are available at all times when bulkhead openings are closed.

**Weather-tight** is the term which applies to structures in the above water part of a ship and means that in any sea conditions water will not penetrate into the ship.

A new ship is a ship:

**.1** out of those specified in 1.1.1.1.1 and 1.1.1.1.2 the keel of which was laid or which was at the similar stage of construction<sup>1</sup>, on or after the date of coming into force of the International Convention on Load Lines, 1966, i.e. 21 July, 1968;

**.2** out of those specified in 1.1.1.1.4 the keel of which was laid or which was at the similar stage of construction on the 1 July, 1975 or after that date.

**Ship's ends** are portions of the ship's length equal to  $0,05L$  from the forward and after perpendiculars.

**Freeboard deck** is the deck from which the freeboard is calculated. Normally, it is the uppermost complete deck exposed to weather and sea, which has permanent means of closing all openings in the weather part thereof, and below which all openings in the sides of the ship are fitted with permanent means of watertight closing.

In a ship having a freeboard deck with a step of over 1 m in length, which extends over the full breadth of the ship, the lowest line of the exposed deck and the continuation of that line parallel to the upper part of the deck is taken as the freeboard deck, as shown in the Fig. 1.2-2.

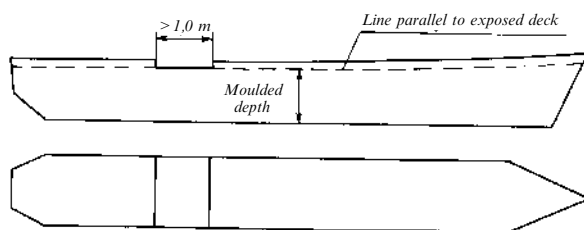

Fig. 1.2-2

At the option of the owner and subject to the approval of the Register, a lower deck may be designated as the freeboard deck provided it is a complete and permanent deck continuous in a fore and aft direction at least between the engine room and peak bulkheads and also continuous athwartships.

Such freeboard deck as a minimum shall consist of suitably framed stringers at the ship sides longitudinally

<sup>1</sup>Means the stage at which construction identifiable with a specific ship begins; and for that ship, assembly has commenced, comprising not less than 50 t or 1 per cent of the estimated mass of all structural materials, whichever is less.

and transversely at each watertight bulkhead which extends to the upper deck, within cargo spaces.

The width of these stringers shall not be less than can be conveniently fitted having regard to the structure and the operation of the ship.

When this lower deck is stepped more than 1 m in length and the discontinuity extends over the full ship breadth, the lowest line of the deck and the continuation of that line parallel to the upper part of the deck outside the step is taken as the freeboard deck. When a lower deck is designated as the freeboard deck, that part of the hull which extends above the freeboard deck is treated as a superstructure so far as concerns the application of the conditions of assignment and the calculation of freeboard.

The following deck may be taken for the freeboard deck on lash lighter carriers and similar docklift ships:

the uppermost continuous deck, provided that all openings are fitted with watertight closures complying with requirements of the present Rules and the aft cargo port is fitted with a watertight closure;

cargo deck, provided that the cargo space has no relevant closures from top or from aft, meanwhile the watertight structure above cargo deck may be treated considering provisions of 4.2.2.3 as a superstructure with the niche in the aft bulkhead in the form of a cargo space;

continuous deck, which doesn't assure waterproof closing of cargo hold from the sea impact, provided that a cargo hold is fitted with watertight closure from the aft up to the level of this deck as well as:

the deck is continuous and uninterrupted in the longitudinal and transverse sections at least beyond the area limited by longitudinal and transverse bulkheads of cargo hold;

the freeboard height is calculated considering adjustment for recess in accordance with provisions of 4.4.9.1 to 4.4.9.3 of the present Rules;

sufficient safety level is confirmed by model tests and calculations considering possible ingress of water into cargo space as a result of atmospheric precipitation and splashing and relevant means of drainage are provided.

**Superstructure deck** is a deck forming the upper boundary of a superstructure.

**Timber deck cargo** is a cargo of timber carried on an uncovered part of a freeboard or superstructure deck. The term does not include wood pulp or similar cargo.

**Sailing ship** is a ship which has a sail area sufficient for her movement independently of the provision of mechanical means of propulsion.

**Perpendiculars** are the forward and after perpendiculars which shall be taken at the forward and after ends of the length  $L$ . The forward perpendicular shall coincide with the foreside of the stem on the waterline on which the length is measured.

Depth for freeboard  $D$  is the moulded depth amidships, plus the freeboard deck thickness at side.

The depth for freeboard in a ship having a rounded gunwale with a radius greater than 4 per cent of the breadth  $B$  or having topsides of unusual form is the depth for freeboard of a ship having a midship section with vertical topsides and with the same round of beam and area of topside section equal to that provided by the actual midship section (Fig. 1.2-3).

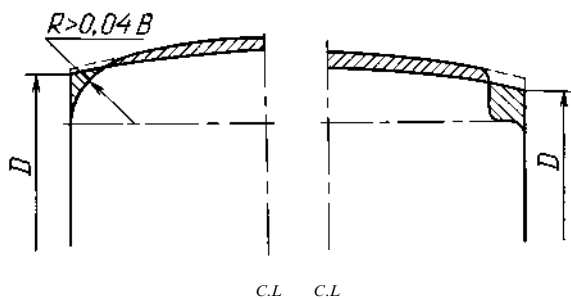

Fig. 1.2-3

Deckhouse is a decked structure on the freeboard or superstructure deck which is set in from the any sides of the ship for more than 4 per cent of the breadth  $B$  and has doors, windows or other similar openings in the outer bulkheads.

Full superstructure is a superstructure which, as a minimum, extends from the forward to the after perpendicular.

Bridge is a superstructure located between aft and forward perpendiculars not reaching either of them.

Ship of river-sea navigation is a self-propelled cargo ship intended for carriage of cargoes by sea and inland waterways without transshipping.

An existing ship is a ship which is not a new ship.

Moulded depth is the vertical distance measured from the top of the keel to the top of the freeboard deck beam at side. In wooden and composite ships this distance is measured from the lower edge of the keel rabbet. Where the form at the lower part of the midship section is of a hollow character or where thick garboards are fitted, the moulded depth is measured from the point where the line of the flat of the bottom continued inwards cuts the side of the keel.

In ships having rounded gunwales, the moulded depth shall be measured to the point of intersection of the moulded lines of deck and sides, the lines extending as though the gunwale were of angular design.

Where a step of over 1 m in length exists in the freeboard deck creating a discontinuity over the full breadth of the ship and the raised part of the deck extends over the point at which the moulded depth shall be determined, the moulded depth shall be

measured to a line of reference extending from the lower part of the deck along a line parallel with the raised part. A step of 1 m or less in length shall be treated as a recess according to 4.4.9.

A hopper dredger is a ship extracting spoil by any appliances and having a hopper for its transportation.

Breadth of ship  $B$  is the maximum breadth of the ship, measured amidships to the moulded line of the frame in a ship with a metal shell and to the outer surface of the hull in a ship with a shell of any other material.

Poop is a superstructure which extends from the stern or, as a minimum, from the after perpendicular forward to a point aft of the forward perpendicular.

Trunk is a decked structure on the freeboard deck set in from the any sides of the ship for more than 4 per cent of the breadth  $B$  and having no doors, windows or other similar openings in the outer bulkheads.

### 1.3 AREAS OF NAVIGATION

**1.3.1** For the purpose of the present Rules the ships in accordance with the areas of navigation permitted for them are divided as follows:

- .1 ships of unrestricted service;
- .2 ships of restricted area of navigation **R1**: navigation is sea areas at seas with a wave height with 3 per cent probability of exceeding 8,5 m and with the ships proceeding not more than 200 miles away from the place of refuge and with an allowable distance between the places of refuge not more than 400 miles;
- .3 ships of restricted area of navigation **R2**: navigation in sea areas at seas with a wave height with 3 per cent probability of exceeding 7,0 m with ships proceeding from the place of refuge not more than 100 miles and with an allowable distance between the places of refuge not more than 200 miles; in this case restrictions for floating cranes are determined by the Register in each particular case;
- .4 ships of restricted area of navigation **R2-RSN**: river-sea navigation at seas with a wave height with 3 per cent probability of exceeding 6,0 m with ships proceeding from the place of refuge; in open seas up to 50 miles and with allowable distance between the places of refuge not more than 100 miles; in enclosed seas up to 100 miles and with an allowable distance between the places of refuge not more than 200 miles;
- .5 ships of restricted area of navigation **R3-RSN**: river-sea navigation at seas with a wave height with 3 per cent probability of exceeding 3,5 m with due regard for particular restrictions on the area and

conditions of navigation resulting from the wind and wave conditions of the basins with determination of a maximum allowable distance from the place of refuge which in no case shall be more than 50 miles;

**.6** ships of restricted area of navigation **R3**: coastal, roadstead and port navigation within limits established by the Register in each case.

#### 1.4 SCOPE OF SURVEY AND CERTIFICATES

##### 1.4.1 Technical documentation.

The documents to be submitted to the Register for assigning the freeboard under provisions of the present Rules are as follows:

- .1** lines drawing;
- .2** general arrangement plans;
- .3** determination of scantlings of hull members;
- .4** information on stability for master;
- .5** calculation on draught, trim and stability of the ship with the compartments flooded (where the requirements of 4.1.2.2, 4.1.3.3 to 4.1.3.5 shall be complied with);
- .6** information on loading and ballasting (if required in accordance with 3.1.3);
- .7** arrangement plan of openings in the hull, superstructures and deckhouses with the specification of the types of closures thereof and the heights of coamings;
- .8** calculation of strength of hatch covers;
- .9** timber deck cargo stowage and securing plans;
- .10** data on the bulwark, guard rails, gangways and walkways, freeing ports and systems (sewage, scupper, ventilation, air pipes, etc.) which shall be in conformity with the requirements of the present Rules;
- .11** freeboard calculation and drawings of the load line mark.

##### 1.4.2 Survey and marking of load lines.

Survey and marking of load lines according to the requirements of these Rules is performed by the Register on ships flying the flag of the Russian Federation, as well as on ships having the class of the Register and flying a foreign flag where a respective authorization is issued to the Register by the flag Administration.

Survey and marking of load lines on ships engaged on international voyages may be carried out also by another organization or person including foreign, duly authorized by the Government. The Register may carry out survey and marking of load lines of ships flying a foreign flag when authorized by the Government concerned. In such cases the Government of the State whose flag the ship is flying fully guarantees the completeness and efficiency of the survey and marking of load lines.

##### 1.4.3 Initial, renewal and annual surveys.

A ship shall be subjected to the surveys specified below:

**.1** initial survey carried out in the course of technical supervision during construction of the ship, or initial survey of the ship built without technical supervision by the Register or a body authorized by it for substitution.

The survey includes a complete inspection of ship's structure and equipment in so far as the ship is covered by the present Rules. This survey shall be such as to ensure that the arrangements, material, and strength of the ship fully comply with the requirements of the present Rules.

Record of Conditions of Assignment of Load Lines, freeboard calculation in accordance with the Register Rules and Load Line Certificates specified in 1.4.5 are drawn up on the basis of the survey results;

**.2** a renewal survey at intervals not exceed five years, except where 1.4.8.2, 1.4.8.5 to 1.4.8.7 are applicable, which shall be such as to ensure that the structure and equipment as to their arrangement, design, materials and strength fully comply with the requirements of the present Rules.

Survey Report for renewal of load lines is drawn up on the basis of the survey results;

**.3** an annual survey within three months before or after each anniversary date of the Certificate, to ensure that alterations have not been made to the hull or superstructures which would affect the calculations determining the freeboard and position of the load lines and so as to ensure the maintenance in an effective condition of fittings and appliances for protection of openings, bulwark, guard rails, freeing ports and means of access to crew's and passengers' quarters, the correct indication of freeboard marks and availability on board of the information required by 3.1.

The annual survey shall be endorsed on the Load Line Certificate or on the Load Line Exemption Certificate issued to a ship exempted in compliance with 1.1.2.2 of the present Rules.

##### 1.4.4 Maintenance of conditions after survey.

After any survey of the ship under 1.4.3 has been completed, no change shall be made in the structure, equipment, arrangements, materials or scantlings covered by the survey, without the sanction of the Register.

##### 1.4.5 Issue of Certificates.

**1.4.5.1** The following shall be issued to ships which have been surveyed and marked in accordance with the present Rules:

**.1** International Load Line Certificate to every ship specified in 1.1.1.1.1;

**.2** Load Line Certificate to every ship referred to in 1.1.1.1.2<sup>1</sup> and in 1.1.1.1.4.

**1.4.5.2** To ships engaged on international voyages and exempted under the provisions of

<sup>1</sup>To ships of unrestricted service except for fishing vessels, an International Load Certificate may be issued. Load lines on such ships shall be marked in compliance with the provisions of Section 2.

1.1.2.1 which have been surveyed and marked in compliance with the present Rules, Regional Load Line Certificate shall be issued.

**1.4.5.3** The following shall be issued to ships embodying features of a novel kind and exempted under the provisions of 1.1.2.2, which have been surveyed and marked in accordance with the present Rules:

**.1** International Load Line Exemption Certificate, to every ship specified in 1.1.1.1.1. The freeboard assigned and ship's service conditions permitted shall be indicated in the Certificate;

**.2** Load Line Certificate to every ship referred to in 1.1.1.1.2 and in 1.1.1.1.4.

It shall be indicated in the Certificate that the ship is assigned freeboard on the basis of, and in compliance with, 1.1.2.2 of these Rules and ship's service conditions permitted shall also be indicated.

**1.4.5.4** To ships indicated in 1.1.1.1.2, which, in exceptional circumstances, undertake a single international voyage under the provisions of 1.1.2.3, and which have been surveyed in compliance with the present Rules, International Load Line Exemption Certificate shall be issued.

A load line for such single voyage is not marked on ship's sides, and the freeboard permitted, note on survey and the conditions of undertaking the voyage being indicated in the International Load Line Exemption Certificate.

**1.4.5.5** To ships indicated in 1.1.1.1.2 and 1.1.1.1.4, which, in exceptional circumstances, undertake a single voyage outside the limits of the area of navigation permitted, under the provisions of 1.1.2.4, and which have been surveyed in compliance with the present Rules, Sailing Permit Certificate for a single passage is issued.

A load line for such single voyage is not marked on ship's sides, and the freeboard permitted, note on survey and the conditions of undertaking the voyage being indicated in Sailing Permit Certificate for a single passage.

**1.4.5.6** To ships flying the Russian Federation flag the Certificates indicated in 1.4.5.1 to 1.4.5.5 are issued by the Register. International Certificates may also be issued by another organization or person, including foreign, duly authorized for it by the Government of the Russian Federation.

The Register may issue international Certificates to foreign ships when authorized by the Government concerned. In such cases, the Government of the State whose flag the ship is flying assumes full responsibility for the Certificate.

**1.4.6 Issue or confirmation of Certificate by another Government.**

**1.4.6.1** The Government of a State — party to the International Convention on Load Lines, may, at the request of the Government of another such State, cause

a ship to be surveyed and, if satisfied that the provisions of this Convention are complied with, shall issue confirm, or authorize the issue (confirmation) of, an International Load Line Certificate to the ship.

**1.4.6.2** A copy of the Certificate, a copy of the Survey Report, and a copy of the freeboard calculation shall be transmitted as early as possible to the requesting Governmental Body.

**1.4.6.3** A Certificate so issued shall contain a statement to the effect that it has been issued at the request of the Government of the State whose flag the ship is or will be flying and it shall have the same force and receive the same recognition as a Certificate issued under 1.4.5.

**1.4.6.4** No International Load Line Certificate shall be issued to a ship which is flying the flag of a State the Government of which has not accepted the International Convention on Load Lines.

#### **1.4.7 Forms of Certificates.**

The arrangement of the printed part of each model Certificate approved by the Register shall be exactly reproduced in any Certificate issued, and in any certified copies thereof. The form of the Certificates shall be that of the models annexed to the International Convention on Load Lines.

International Certificates issued by the Register are drawn up in Russian, the translation into English being obligatory. Other Certificates shall be issued in Russian only.

#### **1.4.8 Duration and validity of Certificates.**

**1.4.8.1** A Load Line Certificate shall be issued for a period which shall not exceed 5 years.

**1.4.8.2** When determining the period of validity of a Load Line Certificate, consideration shall be given to the following.

**1.4.8.2.1** Notwithstanding the requirements of 1.4.8.1, when the renewal survey is completed within 3 months before the expiry date of the existing Certificate, the new Certificate shall be valid from the date of completion of the renewal survey to a date not exceeding 5 years from the date of expiry of the existing Certificate.

**1.4.8.2.2** When the renewal survey is completed after the expiry date of the existing Certificate, the new Certificate shall be valid from the date of completion of the renewal survey to a date not exceeding 5 years from the date of expiry of the existing Certificate.

**1.4.8.2.3** When the renewal survey is completed more than 3 months before the expiry date of the existing Certificate, the new Certificate shall be valid from the date of completion of the renewal survey to a date not exceeding 5 years from the date of completion of the renewal survey.

**1.4.8.3** If a Certificate is issued for a period of less than 5 years, the Register may extend the validity of a

Certificate beyond the expiry date to the maximum period (5 years), provided that the annual surveys, referred to in 1.4.3, applicable when a Certificate is issued for a period of 5 years, are carried out as appropriate.

**1.4.8.4** If, after the renewal survey referred to in 1.4.3.2, a new Certificate cannot be issued to the ship before the expiry date of the existing Certificate, the person or organization carrying out the survey may extend the validity of the existing Certificate for a period which shall not exceed 5 months. This extension shall be endorsed on the Certificate, and shall be granted only where there have been no alterations in the structure, equipment, arrangements, materials or scantlings which affect the ship's freeboard.

**1.4.8.5** If a ship at the time when a Certificate expires is not in a port, in which it shall be surveyed, the Register may extend the period of validity of the Certificate, but this extension shall be granted only for the purpose of allowing the ship to complete its voyage to the port, in which it shall be surveyed, and only in cases where it appears proper and reasonable to do so. No Certificate shall be extended for a period more than 3 months, and a ship to which an extension is granted shall not, on its arrival in the port in which it shall be surveyed, be entitled by virtue of such extension to leave that port without having a new Certificate. When the renewal survey is completed, the new Certificate shall be valid to a date not exceeding 5 years from the date of expiry of the existing Certificate before the extension was granted.

**1.4.8.6** A Certificate issued to a ship engaged in short voyages, which has not been extended under the foregoing provisions of the paragraph, may be extended by the Register for a period of grace of up to one month from the date of expiry stated on it. When the renewal survey is completed, the new Certificate shall be valid to a date not exceeding 5 years from the date of expiry of the existing Certificate before the extension was granted.

**1.4.8.7** In special circumstances, as determined by the Register, a new Certificate need not be dated from the date of expiry of the existing Certificate as required by 1.4.8.2, 1.4.8.5 and 1.4.8.6. In these special circumstances, the new Certificate shall be valid to a date not exceeding 5 years from the date of completion of the renewal survey.

**1.4.8.8** If an annual survey is completed before the period specified in 1.4.3.3 then:

**.1** the anniversary date shown in the Certificate shall be amended by endorsement to a date which shall not be more than 3 months later than the date on which the survey was completed;

**.2** the subsequent annual survey shall be completed at the intervals prescribed by 1.4.3.3 using the new anniversary date;

**.3** the expiry date may remain unchanged, provided one or more annual surveys are carried out so that the maximum intervals between the surveys prescribed by 1.4.3 are not exceeded.

**1.4.8.9** A Load Line Certificate shall cease to be valid if any of the following circumstances exist:

**.1** material alterations have taken place in the hull or superstructures of the ship such as would necessitate the assignment of an increased freeboard;

**.2** the fittings and appliances mentioned in 1.4.3.3 are not maintained in an effective condition;

**.3** the Certificate is not endorsed to show that the ship has been surveyed as provided in 1.4.3.3;

**.4** the structural strength of the ship is lowered to such an extent that the ship is unsafe.

**1.4.8.10** International Load Line Exemption Certificate.

**1.4.8.10.1** The duration of an International Load Line Exemption Certificate issued to a ship exempted from the provisions of the International Convention on Load Lines, under paragraph (2) of article 6 shall not exceed 5 years. Such Certificate shall be subject to a renewal, endorsement, extension and cancellation procedure similar to that provided for an International Load Line Certificate.

**1.4.8.10.2** The duration of an International Load Line Exemption Certificate issued to a ship exempted from the provisions of the International Convention on Load Lines, under paragraph (4) of article 6 shall be limited to the single voyage, for which it is issued.

**1.4.8.11** An international Certificate issued to a ship shall cease to be valid upon the transfer of such a ship to the flag of another state.

## 1.5 GENERAL TECHNICAL REQUIREMENTS

### 1.5.1 General.

**1.5.1.1** For the purpose of establishing uniform principles and requirements with respect to the limits to which ships may be loaded, the present Rules set forth minimum freeboards assigned to ships for navigation in certain areas and during certain seasons of the year.

**1.5.1.2** Nothing in the present Rules shall prevent the assignment of a greater freeboard than the minimum one determined in accordance with the provisions of Sections 3 to 8.

### 1.5.2 Submersion.

**1.5.2.1** The freeboard assigned to a ship shall be indicated on each side of the ship with a deck line, a load line mark and load lines corresponding to maximum draughts to which the ship may be loaded under different conditions of navigation.

**1.5.2.2** When assigning a freeboard, it is assumed that the appropriate load lines on the sides of the ship, corresponding to a season of the year and the



zone or area in which the ship may be, shall not be submerged at any time when the ship puts to sea, during voyage or on arrival. Exceptions are allowed only for the following cases:

.1 when a ship is in fresh water of unit density the load line corresponding to the season, zone or area of navigation may be submerged by the amount of the fresh water allowance shown on the Load Line Certificate.

Where the density is other than unity, an allowance shall be made proportional to the difference between 1,025 and the actual density;

.2 when a ship departs from a port situated on a river or inland waters, deeper loading shall be permitted corresponding to the mass of fuel and all

other materials required for consumption between the port of departure and the sea.

### 1.5.3 Classed ships.

The requirements of the present Rules shall apply to both classed and unclassified ships.

As regards ships classed with the Register, the relevant requirements of the Register Rules for the Classification and Construction of Sea-Going Ships may be applied in lieu of the provisions of Section 3, 5.1, 6.3 and 8.3 and those requirements of the present Rules which relate to the technical documents to be submitted for consideration. Deviations from Rules for the Classification and Construction of Sea-Going Ships may be allowed only if they are not contradicting the present Rules.

## 2 LOAD LINE MARKING ON SHIPS ENGAGED IN INTERNATIONAL VOYAGES

### 2.1 DECK LINE AND LOAD LINE MARK

#### 2.1.1 Deck line.

The deck line is a horizontal line 300 mm in length and 25 mm in breadth. It shall be marked amidships on each side of the ship, and its upper edge shall normally pass through the point where the continuation outwards of the upper surface of the freeboard deck intersects the outer surface of the side shell.

If the freeboard deck is wood-sheathed amidships, the upper edge of the deck line shall pass through the point where the continuation outwards of the upper surface of the actual deck sheathing intersects the outer surface of the side shell of the ship (Fig. 2.1.1-1).

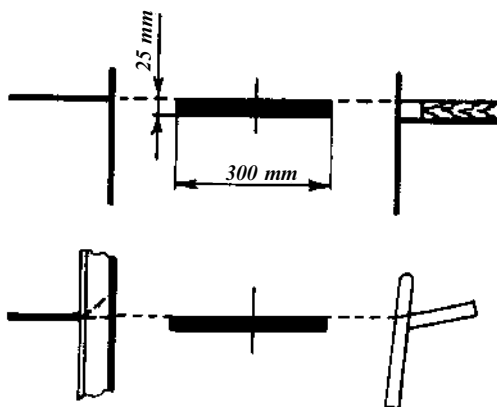

Fig. 2.1.1-1

Where it is impossible or inconvenient to mark the deck line by the above-mentioned method, the deck line may be placed with reference to another fixed point on the ship side in condition that the freeboard is correspondingly corrected. The location

of the reference point and the identification of the freeboard deck shall be indicated in the Load Line Certificate. For example, in a ship having a rounded gunwale the upper edge of the deck line may pass through the point *a* and the distance measured from it to the point *b* (where the continuation outwards of the upper surface of the freeboard deck intersects the outer surface of the shell) shall be indicated in the Load Line Certificate (Fig. 2.1.1-2).

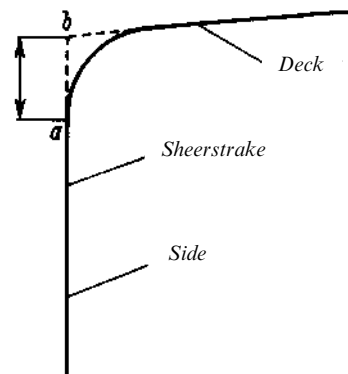

Fig. 2.1.1-2

Where a ship has complete superstructure extending along the whole length of the freeboard deck or the lower deck of the ship is taken as a freeboard deck, the assumed minimum freeboard calculated with no correction for the position of the deck line may be such as the deck line will intersect the ring of the load line mark. In such case, if a ship is assigned a minimum freeboard, the deck line shall be marked on the ship's side in such a manner that it would be higher than the load line mark and the deepest load line. The appropriate correction for the position of the deck line relative to the freeboard deck shall be

taken into account in the calculation and endorsed in the Load Line Certificate.

### 2.1.2 Load line mark.

The load line mark shall consist of a ring 300 mm in outside diameter and 25 mm wide which is intersected by a horizontal line 450 mm in length and 25 mm in breadth, the upper edge of which passes through the centre of the ring. The centre of the ring shall be placed amidships and at a distance equal to the assigned summer freeboard measured vertically below the upper edge of the deck line (Fig. 2.1.2).

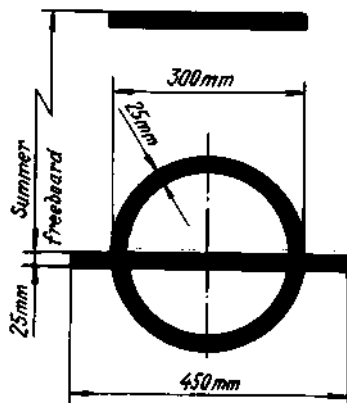

Fig. 2.1.2

## 2.2 LINES TO BE USED WITH LOAD LINE MARK

### 2.2.1 Lines on ships assigned minimum freeboards.

The lines which indicate the position of the load waterlines assigned to a ship for loading in different zones, areas and during different seasonal periods of navigation shall be horizontal lines 230 mm in length and 25 mm in breadth which extend forward of, unless expressly provided otherwise, and at right angles to, a vertical line 25 mm in breadth marked at a distance 540 mm forward of the centre of the load line mark ring (Fig. 2.2.1).

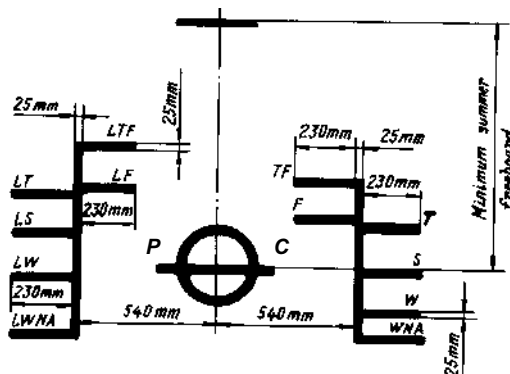

Fig. 2.2.1

The following load lines shall be used:

.1 the summer load line indicated by the upper edge of the line which passes through the centre of the ring and also by the upper edge of a line marked  $\Pi$  ( $S$ )<sup>1</sup>;

.2 the winter load line indicated by the upper edge of a line marked  $\Sigma$  ( $W$ );

.3 the winter North Atlantic load line indicated by the upper edge of a line marked  $\Sigma CA$  ( $WNA$ );

.4 the tropical load line indicated by the upper edge of a line marked  $T$  ( $T$ );

.5 the fresh water load line in summer indicated by the upper edge of a line marked  $\Pi$  ( $F$ ), and placed abaft the vertical line.

The distance between the fresh water load line in summer and the summer load line is the allowance to be made for loading in fresh water at the other load lines  $\Sigma$  ( $W$ ) and  $\Sigma CA$  ( $WNA$ );

.6 the tropical fresh water load line indicated by the upper edge of a line marked  $\Pi\Pi$  ( $TF$ ), and placed abaft the vertical line.

### 2.2.2 Lines on ships assigned minimum timber freeboards.

If timber freeboards are assigned to a cargo ship in accordance with the requirements of Section 5 of the present Rules, the timber load lines shall be marked in addition to ordinary load lines. These lines indicating the position of the load waterlines assigned to a ship for loading in different zones, areas and during different seasonal periods of navigation shall be horizontal lines 230 mm in length and 25 mm in breadth which extend abaft, unless expressly provided otherwise, and at right angles to a vertical line 25 mm in breadth marked at a distance 540 mm abaft the centre of the ring of the load line mark (Fig. 2.2.1).

The following timber load lines shall be used:

.1 the summer timber load line indicated by the upper edge of a line marked  $\Pi\Pi$  ( $LS$ );

.2 the winter timber load line indicated by the upper edge of a line marked  $\Pi\Sigma$  ( $LW$ );

.3 the winter North Atlantic timber load line indicated by the upper edge of a line marked  $\Pi\Sigma CA$  ( $LWNA$ );

.4 the tropical timber load line indicated by the upper edge of a line marked  $\Pi T$  ( $LT$ );

.5 the fresh water timber load line in summer indicated by the upper edge of a line marked  $\Pi\Pi$  ( $LF$ ) and marked forward of the vertical line.

The distance between the fresh water timber load line in summer and the summer timber load line is the allowance to be made for loading in fresh water at the other timber load lines;

<sup>1</sup>When issuing International Load Line Certificate, the load line marking in the text of a Certificate and on ship side shall be performed with the use of Roman letters.

.6 the tropical fresh water timber load line indicated by the upper edge of a line marked and marked forward of the vertical line.

**2.2.3 Lines on sailing ships assigned minimum freeboards.**

On sailing ships only the fresh water load line in summer and the winter North Atlantic load line need be marked associated with the load line mark (Fig. 2.2.3).

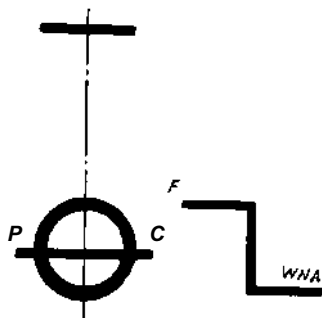

Fig. 2.2.3

Such ships within summer and winter zones, areas and during seasonal periods in salt sea water may be loaded to the upper edge of the horizontal line which passes through the centre of the load line mark ring.

**2.2.4 Subdivision load lines.**

**2.2.4.1** The subdivision load line is indicated by the upper edge of the horizontal line 230 mm in length and 25 mm in breadth, marked C and placed at the level of an approved subdivision loadline abaft the vertical line mentioned in 2.2.1.

If the subdivision load line is below the lowest load line referred to in 2.2.1, it shall be marked abaft the assumed extension of the above vertical line.

**2.2.4.2** In no case shall any subdivision load line be placed above the deepest load line in salt water as determined for the minimum freeboard of the ship or above the horizontal line of the load line mark on ships with a greater than minimum freeboard.

**2.2.4.3** The freeboard corresponding to the subdivision load line shall be measured from the deck line mentioned in 2.1.1.

**2.2.5 Load lines on ships assigned a permanent greater than minimum freeboard.**

On a ship which is, for some reason, assigned a greater than minimum freeboard, the load line marking shall be carried out as illustrated below (Fig. 2.2.5).

**2.2.5.1** The load line mark (Fig. 2.1.2) shall be placed below from the deck line at a distance corresponding to a greater than minimum freeboard assigned.

**2.2.5.2** The load line mark shall be indicated together with the fresh water load line (2.2.1.5) as well as with the winter load line and/or with the winter North Atlantic load line (2.2.1 and 2.2.2) if the winter freeboard and/or the winter North Atlantic freeboard calculated in compliance with the present Rules exceed a greater than minimum freeboard assigned to a ship.

**2.2.5.3** The allowance for fresh water shall in all cases be based on the draught corresponding to a greater than minimum freeboard assigned to a ship.

**2.2.5.4** Except for the fresh water load line no other marks shall be placed above the horizontal line of the load line mark.

**2.2.6 Subdivision load lines on passenger ships.**

The subdivision load line marking for passenger ships shall be carried out as specified below.

**2.2.6.1** On passenger ships intended for carrying the passengers only and whose freeboard corresponding to the deepest subdivision load line is equal to or exceeds the minimum summer freeboard assigned in compliance with the present Rules or a greater than minimum freeboard assigned for some other reasons, the load line mark and the subdivision load line are marked at the level of the deepest subdivision load line approved by the Register.

The subdivision load line for these ships is distinguished by the notation C1.

The other load lines are marked as in case for a ship with a greater than minimum freeboard according to 2.2.5.2 and 2.2.5.3 (Fig. 2.2.6.1).

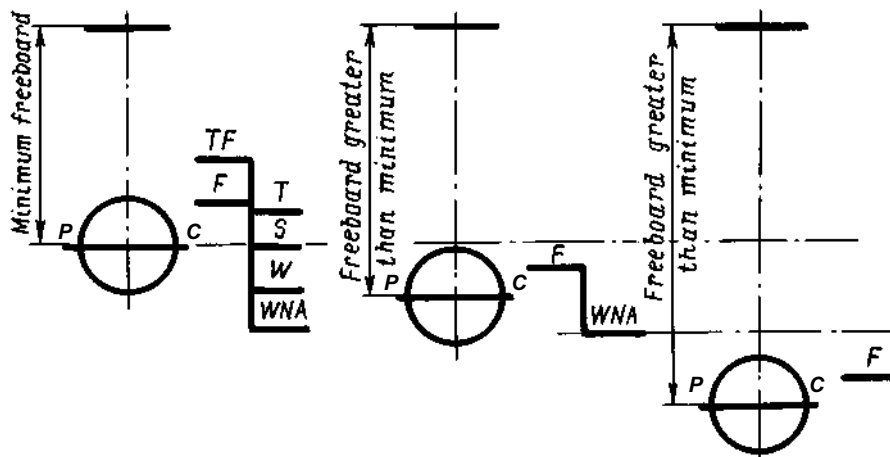

Fig. 2.2.5

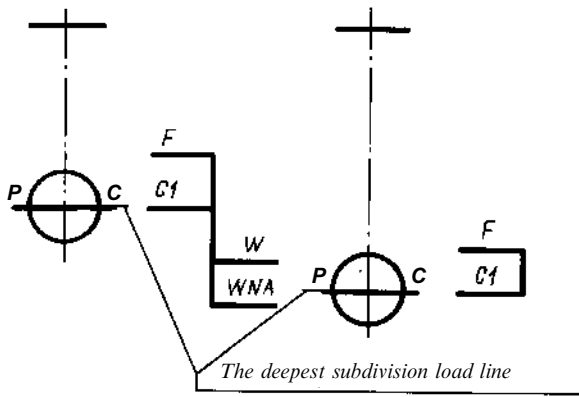

Fig. 2.2.6.1

2.2.6.2 A passenger ship having spaces which are specially adopted for carriage of passengers and cargo alternatively may, if the owners desire, have one or more subdivision load lines assigned and marked to correspond with the subdivision waterlines approved by the Register for the alternative service conditions of the ship.

The subdivision load line marked for the principal condition when carrying passengers is distinguished by the notation C1 and C2, C3, etc. for the rest alternative conditions (Fig. 2.2.6.2).

For the case of ship's service with no passengers on board the subdivision marks C1, C2, C3, etc., may be submerged.

2.2.6.3 The freeboard corresponding to each of the subdivision load lines C1, C2, C3, etc., shall be indicated in the Passenger Ship Safety Certificate.

2.3 LOAD LINE DESIGNATION AND MARKING

2.3.1 Seasonal load line designation.

2.3.1.1 Where the characteristics of a ship or the nature of the ship's service or navigational limits

make any of the seasonal load lines inapplicable, these lines may be omitted and the freeboards therefore shall not be indicated in the International Load Line Certificate.

2.3.1.2 Where a winter North Atlantic load line coincides with winter load line at the same vertical line, this load line shall be marked with a letter 3 (W).

2.3.1.3 Where subdivision loadline coincides with the fresh water load line in summer, this load line shall be marked with letters C1 (CF).

2.3.1.4 If assigned a greater than minimum freeboard, a ship shall not be loaded in salt water deeper than the upper edge of the horizontal line of the load line mark when sailing within all the zones, areas and during the seasonal periods except those subject to marking by the appropriate load lines. This line shall not be marked with any letters relating to the navigational conditions.

In the Load Line Certificate the freeboard for load lines corresponding to the zones and seasonal periods (if applicable) not marked on ship's sides shall be that as for the summer load line.

2.3.1.5 The letters which mark the load lines the outer free ends of which are directed away from the ring shall be placed against these ends of the respective load lines so that the lower edges of the letters are on the level with the upper edges of the lines. It is recommended that the letters which mark the load lines the free ends of which are directed to the ring, if the distance between load lines permits, shall be placed above the load lines at their free ends. The height of the letters indicating the load lines shall be at least 50 mm.

2.3.2 Mark of assigning Authority.

The mark of the Authority by whom the load lines are assigned shall be indicated above the horizontal line which passes through the centre of the load line ring. The mark of the Register consists of the letters P and C measuring 115 mm in height and 75 mm in width and placed on ring sides.

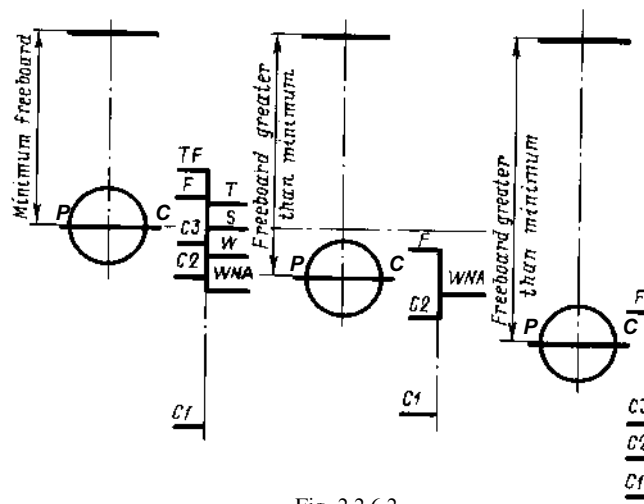

Fig. 2.2.6.2

**2.3.3 Details of marking.**

The ring, lines and letters shall be painted in white or yellow on a dark ground or in black on a light ground. They shall be preliminarily welded to or permanently marked by other method approved by the Register.

On wooden ships they shall be cut into the planking for at least 3 mm depth.

The lines shall be plainly visible and shall be such as to enable freeboard measurements accurate to within  $\pm 2$  mm.

### 3 CONDITIONS OF ASSIGNMENT OF FREEBOARD FOR SHIPS ENGAGED IN INTERNATIONAL VOYAGES

#### 3.1 STRENGTH AND STABILITY OF SHIP

##### 3.1.1 General.

The present Rules are framed on the understanding that the nature and stowage of the cargo, ballast, stores, etc. are such as to avoid excessive structural stresses and to provide adequate stability of the ship under any conditions of service.

##### 3.1.2 Strength of ship.

The Register shall be satisfied that the structural strength of the ship is sufficient throughout the entire range of draughts to that draught which corresponds to the assigned summer freeboard in salt water. This applies to the longitudinal and local strength of the hull and superstructures whose scantlings are determined depending on the ship's draught (freeboard), to the strength of bulkheads at the exposed ends of the enclosed superstructures, and also to the strength of the machinery and boiler casings and protective structures thereof, trunks, deckhouses (used for crew's quarters), companionways, etc.

A ship built and maintained in conformity with the Rules of the Register or other recognized classification society shall be considered to possess adequate strength for the particular freeboard.

##### 3.1.3 Information on ship loading.

The master of every new ship to which the provisions of 1.4, Part II "Hull" of Rules for the Classification and Construction of Sea-Going Ships apply, shall be supplied with sufficient information approved by the Register to enable him to arrange the loading and ballasting of the ship in such a way as to avoid the creation of any unacceptable stresses in the ship's structures.

##### 3.1.4 Stability of ship.

The stability of a ship throughout the entire range of draughts to that draught which corresponds to the least freeboard assigned shall satisfy the requirements of Part IV "Stability" of Rules for the Classification and Construction of Sea-Going Ships.

##### 3.1.5 Information on ship stability.

The master of every ship shall be supplied with sufficient information approved by the Register to give him guidance as to providing the adequate stability of

the ship under different conditions of service. The information shall be drawn up with regard to the provisions of 1.4.11, Part IV "Stability" of Rules for the Classification and Construction of Sea-Going Ships.

#### 3.2 ARRANGEMENT AND MEANS OF CLOSURE OF OPENINGS IN HULL AND SUPERSTRUCTURES

##### 3.2.1 Position of hatchways, doorways and ventilators.

For the purpose of these Rules, two positions of hatchways, doorways and ventilators are defined as follows:

**.1** position 1 — upon exposed freeboard and raised quarter decks, and upon exposed superstructure decks situated forward of a point located a quarter of the ship's length from the forward perpendicular.

**.2** position 2 — upon exposed superstructure decks situated outside a quarter of the ship's length from the forward perpendicular.

Where superstructure height located within a quarter of the ship's length from the forward perpendicular exceeds twice the standard height of the superstructure, the superstructure deck may be related to position 2.

##### 3.2.2 Doors.

**3.2.2.1** All access openings in bulkheads at ends of enclosed superstructures shall be fitted with doors of steel or other equivalent material, permanently and strongly attached to the bulkhead, and framed. The doors shall be stiffened and fitted so that the whole structure is of equivalent strength to the unpierced bulkhead and weathertight when closed. The means for securing these doors weathertight shall consist of gaskets and clamping devices or other equivalent means and shall be permanently attached to the bulkhead or to the doors themselves, and the doors shall be so arranged that they can be operated from both sides of the bulkhead.

Doors shall generally open outwards. Doors which open inwards shall be specially approved by the Register.

**3.2.2.2** Except as otherwise provided in the present Rules, the height of the sills of access openings in bulkheads at ends of enclosed superstructures shall be at least 380 mm above the deck.

### 3.2.3 Cargo and other hatchways.

The construction and the means for securing the weathertightness of cargo and other hatchways in positions 1 and 2 shall be at least equivalent to the requirements of 3.2.5. The applicability of provisions under 3.2.4 to such hatchways is subject to special consideration by the Register.

Where the design specifications stipulate greater assumed loads on hatchway covers than those stated below, the covers shall be calculated for these greater loads. In this case, the requirements concerning the factors of structure strength and deflection, given below, shall be complied with.

The present Rules set forth no specific requirements as to coamings and covers of exposed hatchways on decks above the superstructure deck, except for the requirements for non-watertight hatch covers on container ships given in 3.2.14.

### 3.2.4 Hatchways closed by portable covers and secured weathertight by tarpaulins and battening devices.

**3.2.4.1** The coamings of hatchways shall be of substantial construction, and their height above the deck shall be at least as follows:

- 600 mm if in position 1;
- 450 mm if in position 2.

**3.2.4.2** The width of each bearing surface for hatchways covers shall be at least 65 mm.

**3.2.4.3** Where hatchway covers are made of wood the finished thickness shall be at least 60 mm in association with a span of not more than 1,5 m.

**3.2.4.4** Where covers are made of steel the strength shall be calculated with assumed loads specified in 3.2.5.2 and the product of maximum stress thus calculated and the factor 1,25 shall not exceed the minimum ultimate strength of the material. The design shall be such that the deflection of the covers shall not exceed 0,0056 times the span under these loads.

**3.2.4.5** Where portable beams for supporting hatchway covers are made of steel, the strength shall be calculated with the assumed loads not less than 3,5 t/m<sup>2</sup> on hatchways in position 1, and not less than 2,6 t/m<sup>2</sup> on hatchways in position 2, and the product of maximum stress thus calculated and the factor 1,47 shall not exceed the minimum ultimate strength of the material. The design shall be such that the deflection of the covers shall not exceed 0,0044 times the span under these loads.

**3.2.4.6** For ships less than 100 m in length assumed loads specified in 3.2.4.5 may be reduced to the following values: for ships 24 m in length on hatchways in position 1 — to 2,0 t/m<sup>2</sup> and on hatchways in position 2 — to 1,5 t/m<sup>2</sup>; for ships of length over 24 m but less than 100 m the values of the assumed loads shall be obtained by linear interpolation, assuming the values specified in 3.2.4.5 for ships 100 m in length.

**3.2.4.7** Where pontoon covers used in place of portable beams and covers are made of steel, the strength shall be calculated with the assumed loads given in 3.2.5.2, and the product of maximum stress thus calculated and the factor 1,47 shall not exceed the minimum ultimate strength of the material. The design shall be such that the deflection of the covers shall not exceed 0,0044 times the span under these loads. Steel plating forming the top of the covers shall be not less in thickness than 1 per cent of the spacing of stiffeners or 6 mm, whichever is more.

**3.2.4.8** The strength and stiffness of covers made of materials other than common carbon steel shall be equivalent to those of carbon steel. Drawing and calculations shall be submitted to the Register for special consideration.

**3.2.4.9** Carriers or sockets for portable beams shall be of substantial construction, and shall provide means for the efficient fitting and securing of the beams. Where rolling types of beams are used, the arrangements shall ensure that the beams remain properly in position when the hatchways are closed.

**3.2.4.10** Cleats shall be set to fit the taper of the wedges. They shall be at least 65 mm wide and spaced not more than 600 mm centre to centre. The cleats along each side or end shall be not more than 150 mm from the hatch corners.

**3.2.4.11** Battens and wedges shall be efficient and in good condition. Wedges shall be of tough wood or other equivalent material. They shall have a cone of not more than 1 : 6 and shall be not less than 13 mm thick at the toes.

**3.2.4.12** At least two layers of tarpaulin in good condition shall be provided for each hatchway in position 1 or 2. The tarpaulins shall be waterproof and of ample strength. The tarpaulins shall be of approved standard weight and quality.

**3.2.4.13** For all hatchways in position 1 or 2 steel bars or other equivalent means shall be provided in order to secure efficiently and independently each section of hatchway covers after the tarpaulins are battened down. Hatchway covers of more than 1,5 m in length shall be secured by at least two such securing appliances.

Where securing devices which do not provide a flat bearing surface (e.g., steel wire rope lashings) are used, care shall be taken that tarpaulins are adequately protected from possible damage.

### 3.2.5 Hatchways closed by weathertight covers of steel or other equivalent material.

**3.2.5.1** All hatchways in position 1 or 2 shall be fitted with covers made of steel or other equivalent material. Covers shall be weathertight and fitted with gaskets and clamping devices. The means for strengthening and maintaining weathertightness shall comply with the requirements of 7.10.8, Part III "Equipment, Arrangement and Outfit" of Rules for

the Classification and Construction of Sea-Going Ships. The arrangements shall ensure that the tightness can be maintained in any sea conditions. For this purpose, tests for tightness shall be required at the initial surveys, and may be required at annual and renewal surveys or at more frequent intervals.

The coamings of hatchways shall, generally, comply with the requirements of 3.2.4.1.

Height of the coamings of hatchways, complying with the requirements of 3.2.5.2 to 3.2.5.3, may be reduced or the coamings may be lacking, if the Register makes sure that the ship's safety would not decrease at any sea condition. At that special attention shall be paid to provision of the safety sealing of hatch covers without coamings.

**3.2.5.2** Minimum design loads for hatchway covers.

**3.2.5.2.1** For ships of 100 m in length and above design loads for hatchway covers shall be calculated in the following way:

**.1** position 1 hatch covers located in the forward quarter of the ship's length shall be designed for wave loads, in t/m<sup>2</sup>, at the forward perpendicular, determined by the following formula:

$$Load = 5 + (L_L - 100)a, \tag{3.2.5.2.1.1}$$

where  $L_L$  is assumed as equal to length  $L$  but not exceeding 340 m;  
 $a$  is given in Table 3.2.5.2.1.1, and reduced linearly to 3,5 t/m<sup>2</sup> at the end of the forward quarter's length. The design load used for each hatch cover panel shall be such as the one determined at its midpoint location;

Table 3.2.5.2.1.1

|  | $a$    |
|--|--------|
| Type B freeboard ships   | 0,0074 |
| Ships assigned reduced freeboard in compliance with 4.1.3.4 or 4.1.3.5 | 0,0363 |

**.2** all other position 1 hatch covers shall be designed to 3,5 t/m<sup>2</sup>;

**.3** position 2 hatch covers shall be designed to 2,6 t/m<sup>2</sup>;

**.4** where a position 1 hatchway is located at least one superstructure standard height higher than the freeboard deck, it may be designed to the load specified in Table 3.2.5.2.3 for hatchways located on the superstructure deck.

**3.2.5.2.2** For ships 24 m in length, design loads for hatchway covers shall be calculated in the following way:

**.1** position 1 hatch covers located in the forward quarter of the ship's length shall be designed for wave loads of 2,43 t/m<sup>2</sup> at the forward perpendicular and reduced linearly to 2,0 t/m<sup>2</sup> at the end of the forward quarter's length. The design load used for each hatch cover panel shall be such as the one determined at its midpoint location;

**.2** all other position 1 hatch covers shall be designed to 2,0 t/m<sup>2</sup>;

**.3** position 2 hatch covers shall be designed to 1,5 t/m<sup>2</sup>;

**.4** where a position 1 hatchway is located at least one superstructure standard height higher than the freeboard deck, it may be designed to the load specified in Table 3.2.5.2.3 for hatchways located on the superstructure deck.

**3.2.5.2.3** For ships between 24 m and 100 m in length, wave loads shall be obtained by linear interpolation of the values shown in table 3.2.5.2.3.

Table 3.2.5.2.3

|                     | Longitudinal position |                      |                      |
|---------------------|-----------------------|----------------------|----------------------|
|                     | Forward perpendicular | 0,25L                | Aft of 0,25L         |
| $L > 100$ m         |                       |                      |                      |
| Freeboard deck      | Formula 3.2.5.2.1.1   | 3,5 t/m <sup>2</sup> | 3,5 t/m <sup>2</sup> |
| Superstructure deck | 3,5 t/m <sup>2</sup>  |                      | 2,6 t/m <sup>2</sup> |
| $L = 100$ m         |                       |                      |                      |
| Freeboard deck      | 5,0 t/m <sup>2</sup>  | 3,5 t/m <sup>2</sup> | 3,5 t/m <sup>2</sup> |
| Superstructure deck | 3,5 t/m <sup>2</sup>  |                      | 2,6 t/m <sup>2</sup> |
| $L = 24$ m          |                       |                      |                      |
| Freeboard deck      | 2,43 t/m <sup>2</sup> | 2,0 t/m <sup>2</sup> | 2,0 t/m <sup>2</sup> |
| Superstructure deck | 2,0 t/m <sup>2</sup>  |                      | 1,5 t/m <sup>2</sup> |

**3.2.5.3** All hatch covers shall be so designed as:

**.1** the product of the maximum stress determined in accordance with the above loads and the factor of 1,25 does not exceed the minimum upper yield point strength of the material in tension and the critical buckling strength in compression;

**.2** the deflection is limited to not more than 0,0056 times the span;

**.3** steel plating forming the tops of covers is not less in thickness than 1 per cent of the spacing of stiffeners or 6 mm, whichever is more;

**.4** for the hatch covers of cargo holds the following corrosion additions shall be added to the net thickness required by 3.2.5.3.1, 3.2.5.3.2 and 3.2.5.3.3:

for single skin hatch covers, a corrosion addition is equal to 2,0 mm for all plating and stiffeners of all ship types;

for double skin hatch covers, a corrosion addition is equal to 2,0 mm for top and bottom plating and 1,5 mm for the internal structure for bulk carriers, ore carriers and combination carriers, a corrosion addition is equal to 1,5 mm for top and bottom plating and 1,0 mm for the internal structure of other ship types;

corrosion addition is equal to 1,0 mm for all construction elements of the hatch covers in way of cellular cargo holds intended for containers.

*Note.* When calculating the stress and deflection of hatchway covers, the design pressure at the hatch cover surface shall be determined proceeding from the above design loads in units of mass by area and from vertical acceleration equal to 1,0 g.

**3.2.5.4** The means for securing and maintaining weathertightness other than gaskets and clamping devices shall be approved by the Register.

**3.2.5.5** Hatch covers which rest on coamings shall be secured in their closed position by means capable of withstanding horizontally acting loads in any sea conditions.

**3.2.6 Engine room openings.**

**3.2.6.1** Engine room openings in position 1 or 2 shall be properly framed and efficiently enclosed by steel casings of ample strength. Where the casings are not protected by any superstructures, trunks or deckhouses arranged to the satisfaction of the Register, their strength shall be specially considered.

The doors giving access to such casings shall comply with the requirements of 3.2.2.1.

The height of the sills shall be at least 600 mm above the deck plating if in position 1, and at least 380 mm if in position 2. Other openings in such casings shall be fitted with equivalent covers, permanently attached in their proper positions.

Where machinery casings are not protected by other structures, double doors complying with the requirements of 3.2.2.1 shall be required for ships with assigned reduced freeboards in compliance with 4.1.3.4 or 4.1.3.5. An inner sill of 230 mm in conjunction with the outer sill of 600 mm shall be provided.

**3.2.6.2** Coamings of any fiddley, hatches, funnel, pipes or engine room ventilators in an exposed position on the freeboard or superstructure deck shall be as high above the deck as is reasonable and practicable. Fiddley hatch openings shall be fitted with strong covers of steel or other equivalent material permanently attached in their proper positions and capable of being secured weathertight.

Where the height of ventilator coamings of an engine room or emergency generator room does not comply with the requirements of 3.2.8.3, weathertight closing appliances required under 3.2.8.4 shall be used together with other suitable appliances capable to ensure continuous and adequate ventilation of the spaces.

Ventilators necessary to continuously supply the emergency generator room, if this is considered buoyant in the stability calculation or protecting opening leading below, shall have coamings of sufficient height to comply with the requirements of 3.2.8.3, without having to fit weathertight closing appliances.

**3.2.7 Miscellaneous openings in freeboard and superstructure decks.**

**3.2.7.1** Manholes and flush scuttles in position 1

and 2 or within superstructures other than enclosed superstructures shall be closed by substantial covers capable of being made watertight. Unless secured by closely spaced bolts, the covers shall be permanently attached with the use of hinges or by another approved method.

**3.2.7.2** Other openings in freeboard decks other than hatchways, engine room space openings, manholes and flush scuttles shall be protected by an enclosed superstructure, or by a deckhouse or companionway of equivalent strength and weathertightness. Any such opening in an exposed superstructure deck or in the top of a deckhouse on the freeboard deck which gives access to spaces below the freeboard deck or spaces within an enclosed superstructure shall be protected by an efficient deckhouse or companionway.

Doorways in such deckhouses or companionways shall be fitted with doors complying with the requirements of 3.2.2.1.

Where the openings within the deckhouses are enclosed by companionways of appropriate strength fitted with doors complying with the requirements of 3.2.2, the external doors of the deckhouse need not meet these requirements.

Openings in the top of an efficient deckhouse having a height not less than the standard superstructure height need not be protected by an efficient deckhouse or companionway provided the deckhouse is situated on a raised quarterdeck of at least standard height. These openings shall be provided with closing means approved by the Register.

**3.2.7.3** The height of sills the doorways in the bulkheads of the bridge or poop, where the latter comply with the requirements applied to enclosed superstructures, except for provision of additional accesses, shall be at least 600 mm. The height of the sills to the doorways in the bulkheads of the companionways in position 1, shall be at least 600 mm, and in position 2 — at least 380 mm.

The height of sills to doorways in the bulkheads of the deckhouses leading to the spaces located below the freeboard deck or in the spaces of below located enclosed substructure shall be at least: 600 mm — in position 1, if the deckhouse has no additional access from the above-located deck; 380 mm — in position 1, if such additional access is provided, as well as in position 2.

**3.2.7.4** Where superstructures, companionways are not of such a strength as to satisfy the requirements of 3.1.2 or the closing appliances therein do not comply with the requirements of 3.2.2, 3.2.7.1, 3.2.7.2, 3.2.7.3 and 3.2.12, the interior access openings in such superstructures and companionways shall be considered exposed, i.e. situated in the weather deck.



### **3.2.8 Ventilators.**

**3.2.8.1** Ventilators in position 1 or 2 to spaces below freeboard deck or decks of enclosed superstructures shall have coamings of steel or other equivalent material, substantially constructed and efficiently connected to the deck.

Ventilators in position 1 shall have coamings of at least 900 mm in height above the deck plating; in position 2 the coamings shall be of a height at least 760 mm above the deck plating.

The possibility of reduction in the height of ventilator coamings is subject to special consideration by the Register in each particular case.

If a ventilator coaming is more than 900 mm in height, it shall be specially strengthened.

**3.2.8.2** Ventilators passing through open superstructures shall have substantially constructed coamings of steel or other equivalent material at the freeboard deck.

**3.2.8.3** Ventilators in position 1 the coamings of which extend to more than 4,5 m above the deck, and in position 2 the coamings of which extend to more than 2,3 m above the deck, need not be fitted with closing appliances.

**3.2.8.4** Except as provided in 3.2.8.3, ventilator openings shall be provided with efficient weathertight closing appliances. In ships of not more than 100 m in length the closing appliances shall be permanently attached. Where not so provided in other ships, they shall be conveniently stowed near the ventilators to which they shall be fitted.

The closing appliances shall be of steel or other equivalent material. The use of wooden plugs and tarpaulin covers in positions 1 and 2 is not acceptable.

### **3.2.9 Air pipes.**

Where air pipes to ballast and other tanks extend above the freeboard or superstructure decks, the exposed parts of the pipes shall be of substantial construction. The height from the deck to the point where liquid may have access below shall be at least 760 mm on the freeboard deck and 450 mm on the superstructure deck. Where these heights may interfere with the working of the ship, a lower height may be approved, provided the closing appliances and other circumstances justify a lower height. The openings of the air pipes shall be fitted with closing means permanently attached and capable of efficiently preventing sea water from penetrating into the tanks. The closing appliances for the openings of the air pipes situated on exposed decks shall be operated automatically. Pressure-vacuum valves may be accepted on tankers.

### **3.2.10 Cargo ports and other similar openings.**

**3.2.10.1** Cargo ports and other similar openings in the sides of ships below the freeboard deck shall be

fitted with doors so designed as to ensure watertightness and structural integrity commensurate with the surrounding shell plating.

The number of such openings shall be the minimum compatible with the design and proper working of the ship.

The lower edge of such openings shall generally not be below a line drawn parallel to the freeboard deck at side, which is at its lowest point at least 230 mm above the upper edge of the deepest load line. The lower position of openings may be permitted in exceptional cases, provided it is proved to the Register that the safety of the ship is in no way impaired.

In such cases there shall be provided second inner watertight doors of equivalent strength, leakage detection device and drainage of this compartment to the bilges controlled by an easily accessible screw-down valve or other arrangements approved by the Register. The outer doors shall preferably open outwards.

**3.2.10.2** Stern, bow and side doors of large dimensions, when manual devices would not be readily accessible or convenient shall be normally secured by means of power systems.

Means of retaining doors watertight shall also be provided for emergency use in case of failure of the power systems.

### **3.2.11 Scuppers, inlets and discharges and garbage chutes.**

**3.2.11.1** Discharges led through the shell either from spaces below the freeboard deck or from within superstructures and deckhouses on the freeboard deck fitted with doors complying with the requirements of 3.2.2, except as provided in 3.2.11.2, shall be fitted with efficient and accessible means for preventing water from passing inboard.

Normally each discharge from piping which have, or may have, open ends within the said spaces shall be fitted with one non-return valve with a positive means of closing it from a position above the bulkhead deck in ships having the subdivision mark in the class notation, and from a position above the freeboard deck in other ships. The means for operating the positive action valves shall be readily accessible and provided with an indicator showing whether the valve is open or closed.

An equivalent to one non-return valve with a positive means of closing would be one non-return valve and one sluice valve controlled from above the bulkhead deck or the freeboard deck, respectively.

In ships having no subdivision distinguishing mark in the class notation the valve drives of sanitary discharges and scuppers led overboard through the shell in way of manned engine rooms may be locally operated.

Where, however, the vertical distance from the summer load waterline (for ships with timber freeboard, from the summer timber load waterline), to the inboard open end of the discharge pipe exceeds  $0,01L$ , the discharge pipe may have two non-return valves without positive means of closing. In this case, one of the valves is installed at side and inboard valve is above the deepest waterline in salt water assigned to the given ship and shall be always accessible under service conditions. Where a locally controlled sluice valve is interposed between the two non-return valves the inboard non-return valve may be situated below the deepest waterline in salt water assigned to the ship.

Where this distance to the inboard open end of the discharge pipe exceeds  $0,02L$ , a single non-return valve without positive means of closing may be installed at side. In this case, in ships complying with the requirements of Part V "Subdivision" of Rules for the Classification and Construction of Sea-Going Ships, a single valve may be fitted only where the distance from the inboard end of the discharge pipe to the damage waterline is not less than 300 mm.

The above requirements for the installation of non-return valves do not apply to discharges which shall be compulsorily closed at sea, for example, openings for gravity draining of topside ballast tanks. Sluice valves controlled from the deck are sufficient for such discharges.

Garbage chutes, instead of a non-return valve with positive means of closing from a position above the freeboard deck, may be provided with two gate valves operated from the deck, where the garbage chute is charged, and incorporating an interlocking system. The lower gate valve shall be additionally operated from a position above the freeboard deck. The two gate valves shall be so spaced that the interlocking system cannot be rendered inoperative.

It is recommended that the charging end of the garbage chute rises to a height of at least 1000 mm above the waterline at the ship summer load line draught and remains above the waterline when the ship lists up to  $8,5^\circ$  either way from this position.

If the charging end of the garbage chute rises above the summer waterline to a height exceeding  $0,01L$ , the gate valve need not be operated from a position above the freeboard deck, provided that the gate valve at the side is accessible at all times under service conditions.

As an alternative to this the upper gate valve may be replaced by hinged cover fitted to the charging end of the garbage chute and impenetrable to ingress of sea water. Coincidentally with such replacement a damper shall be fitted instead of the lower gate valve. The cover and the damper shall be interlocked to prevent them from being simultaneously opened.

Structural components of the garbage chute, including the cover, shall have thickness sufficient to impart strength.

The control gear of the gate valves and/or hinged cover shall be conspicuously marked: "Keep closed when not in use".

The charging end of the garbage chute shall be situated at a height of 300 mm above the margin line in a passenger ship or the deepest damage waterline in a cargo ship covered by the requirements of Part V "Subdivision" of Rules for the Classification and Construction of Sea-Going Ships. Otherwise the charging end of a garbage chute in such ships shall have a non-return water tight cover/valve fitted in an easily accessible place above the deepest load line with a screw gear operated from a position above the bulkhead deck provided with open/closed indicators and marking "Keep closed when not in use".

**3.2.11.2** Scuppers which penetrate the shell and originate from enclosed superstructures intended for cargo may only be fitted on condition the freeboard deck side line is immersed with the ship listed more than  $5^\circ$ . In other cases the drainage shall be led inboard in accordance with the requirements of 7.12, Part VIII "Systems and Piping" of Rules for the Classification and Construction of Sea-Going Ships.

**3.2.11.3** In manned engine rooms spaces main and auxiliary sea inlets and discharges in connection with the operation of machinery may be controlled locally. The controls shall be readily accessible and shall be provided with indicators showing whether the valve is open or closed.

Fully-automated engine rooms shall, as for the control by the said valves, be considered as equivalent to manned engine rooms, provided suitable warning devices are incorporated to indicate leakage of water into these spaces.

**3.2.11.4** Scuppers and discharge pipes originating from exposed decks and spaces other than those mentioned in 3.2.11.1 and penetrating the shell either more than 450 mm below the freeboard deck or less than 600 mm above the summer load waterline shall be provided with non-return valves at the shell.

These valves may be omitted, when the thickness of piping where it passes through enclosed superstructure and below the freeboard deck, is not less than specified in 3.2.11.8.

**3.2.11.5** Scuppers leading from superstructures and deckhouses which have access openings not fitted with doors complying with the requirements of 3.2.2 shall be led overboard.

**3.2.11.6** All shell fittings and valves required by this paragraph shall be of steel, bronze or other ductile material approved by the Register.

Valves of grey cast iron or other similar material are not acceptable.

All pipes which are covered by this paragraph shall be made of steel or other equivalent material approved by the Register.

**3.2.11.7** Unless otherwise specified in the present Rules, scuppers and discharge pipes shall have wall thickness not less than the following:

4,5 mm, where the external pipe diameter does not exceed 155 mm;

6,0 mm, where the external pipe diameter is 230 mm or more.

Intermediate values shall be determined by linear interpolation.

**3.2.11.8** Any scuppers and discharge pipes within the area between the shell and the closest valve thereto required by the present Rules shall have wall thickness not less than the following:

7,0 mm, where the external pipe diameter does not exceed 80 mm;

10,0 mm, where the external pipe diameter equals 180 mm;

12,5 mm, where the external pipe diameter is 220 mm or more.

Intermediate values shall be determined by linear interpolation.

### **3.2.12 Side scuttles, windows and skylights.**

**3.2.12.1** Side scuttles and windows, together with their glasses and deadlights, if fitted, shall be of substantial construction approved by the Register.

Scuttle mean round or oval openings of not more than 0,16 m<sup>2</sup> in area. Windows are generally rectangular openings with rounded off angles. Round or oval openings of more than 0,16 m<sup>2</sup> in area are commonly regarded as windows.

**3.2.12.2** Side scuttles shall be fitted with efficient hinged inside deadlights, if they are fitted:

below the freeboard deck,

within enclosed superstructures of the first tier,

within deckhouses and companionways on the freeboard deck which protect access openings to spaces situated below or the buoyancy of which is allowed for in the stability calculations.

**3.2.12.3** Deadlights required by these Rules shall ensure watertight closure of scuttles fitted below the freeboard deck and weathertight closure of scuttles and windows fitted above the freeboard deck.

**3.2.12.4** No side scuttle shall be fitted in a position that its sill is below a line drawn parallel to the freeboard deck at side having its lowest point located 0,025 of the ship's breadth above the summer load line (or above timber summer load line, if this load line is assigned to the ship) or 500 mm, whichever is the greater distance.

**3.2.12.5** In ships assigned freeboard with regard to the damage stability requirements, side scuttles which may immerse at any stage of flooding or equalization of the ship in any damage condition

under consideration (except for the case of damage to the compartment where they are fitted) shall be of non-opening type.

**3.2.12.6** No window shall be fitted in areas listed in 3.2.12.2.

Windows and side scuttles fitted in side plating within superstructure of the second tier which protect direct access downwards or allowed for in the stability calculations shall be fitted with efficient hinged inside deadlights.

Recessed windows and side scuttles fitted within superstructures and deckhouses of the second tier, which protect direct access downwards to spaces listed in 3.2.12.2 shall be fitted with deadlights hinged inside, or if an access thereto is provided, with deadlights permanently attached outside.

Deadlights may not be fitted to windows and scuttles in spaces within superstructures of the second tier if cabin bulkheads and doors separate these scuttles or windows from unprotected access downwards and where these spaces are considered buoyant in the stability calculations.

**3.2.12.7** Deckhouses situated on a raised quarter-deck or on a superstructure deck having the height less than the standard height, may be treated, with respect to the deadlight requirements, as situated in the second tier, provided that the height of the raised quarterdeck or superstructure is not less than the standard quarterdeck height.

**3.2.12.8** The glass for windows in the covers of skylights shall have a thickness consistent with the dimensions of windows and their position on board ship, as it is required for side scuttles and windows. Windows in the covers of skylights, regardless of their position on board ship shall be protected from mechanical damages, and when located in area 1 or 2, they shall be fitted with deadlights permanently attached inside or outside.

### **3.2.13 Freeing ports.**

**3.2.13.1** Where bulwarks on the weather portions of freeboard or superstructure decks form wells, ample provision shall be made for rapidly freeing the decks of water and for draining them.

Except as provided in 3.2.13.2, 3.2.13.3 and 3.2.13.4, the minimum freeing port area  $A$ , m<sup>2</sup>, on each side of the ship for each well in position 1 shall be that given by the following formulae in cases where the sheer in way of the well is standard or greater than standard. The minimum area for each well on superstructure decks in position 2 shall be one-half of the area given by these formulae.

Where the length of bulwark  $l$  in the well is 20 m or less

$$A = 0,7 + 0,035 l. \quad (3.2.13.1-1)$$

Where  $l$  exceeds 20 m

$$A = 0,07l. \quad (3.2.13.1-2)$$

$l$  need in no case be taken as greater than  $0,7L$ .

If the bulwark is more than 1,2 m in average height, the required area shall be increased by  $0,004 \text{ m}^2$  per metre of length of well for each 0,1 m difference in height. If the bulwark is less than 0,9 m in average height, the required area may be decreased  $0,004 \text{ m}^2$  per metre of length of well for each 0,1 m difference in height.

**3.2.13.2** In ships with no sheer the area calculated in accordance with 3.2.13.1 shall be increased by 50 per cent. Where the sheer is less than standard, the percentage shall be obtained by linear interpolation.

**3.2.13.3** In a flush deck ship with a substantial deckhouse amidships, which has a breadth at least  $0,8B$  and passageways along the sides of the ship not exceeding 1,5 m, the freeing port area on each side may be calculated in accordance with 3.2.13.1 for each part of the well forward of, and abaft, the deckhouse, based upon their length, but not for the whole well with limitation of its length by the value of  $0,7L$ .

Where an effective screen bulkhead is fitted completely across the ship, at the forward end of a midship deckhouse, the freeing port area may be calculated for the wells forward of, and abaft, this bulkhead without limitations to the deckhouse breadth.

**3.2.13.4** Where a ship is fitted with a trunk which does not comply with the requirements of 4.2.4.1.5 or where continuous (or substantially continuous) longitudinal hatchway side coamings are fitted between detached superstructures the minimum area of the freeing port openings shall be obtained from Table 3.2.13.4.

Table 3.2.13.4

| Breadth of hatchway or trunk in relation to the breadth of ship, per cent                           | Area of freeing ports in relation to the total area of the bulwark, per cent |
|---|--|
| 40 and less   | 20   |
| 75 and more   | 10   |
| Note. The area of freeing ports at intermediate breadths shall be obtained by linear interpolation. |  |

**3.2.13.5** Where passageways formed by interruptions in hatchways side coamings are fitted between detached superstructures, the necessary area of freeing ports shall be determined as follows.

**3.2.13.5.1** Minimum area of freeing ports in a bulwark shall be determined in accordance with 3.2.13.1 and 3.2.13.2 if limited by the well height the total area of passageways with due regard to equipment fitted between the hatchways is not less than the value calculated in accordance with 3.2.13.4

when the hatchway coamings are assumed to be continuous.

**3.2.13.5.2** Minimum area of freeing ports in a bulwark shall be determined in accordance with 3.2.13.4 if limited by the well height the total area of the passageways with due regard for the equipment fitted between the hatchways is equal to or less than the value according to 3.2.13.1 and 3.2.13.2.

**3.2.13.5.3** Minimum area of freeing ports in a bulwark  $A$ ,  $\text{m}^2$ , where the area of passageways between hatchways is less than given in 3.2.13.5.1, but more than given in 3.2.13.5.2 above can be determined by interpolation using the formula

$$A = A_1 + A_2 - f_p \quad (3.2.13.5.3)$$

where  $A_1$  = minimum area of the freeing ports calculated in accordance with 3.2.13.1 and 3.2.13.2, where the coamings are considered to have passageways sufficient for water flowing,  $\text{m}^2$ ;

$A_2$  = minimum area of the freeing ports calculated in accordance with 3.2.13.4, where the coamings are considered to be continuous,  $\text{m}^2$ ;

$f_p$  = limited by the well height the total area of passageways with due regard for the equipment fitted on the deck between hatchways,  $\text{m}^2$ .

**3.2.13.6** In ships having superstructures which are open at either or both ends, the area of the freeing ports for such superstructures and for the wells formed by the bulwark on the open deck and communicating with the open superstructure shall be calculated according to the following procedure:

**3.2.13.6.1** The freeing port area in the bulwark which encloses a well communicating with the open superstructure shall be calculated in full compliance with 3.2.13.1 and 3.2.13.2, except that the Formulae (3.1.13.1-1) or (3.1.13.1-2) for determination of the minimum area  $A$  shall be chosen depending on the common length  $l_t$  of the well and open space within the superstructure but the length  $l_w$  of the well considered shall be used in the calculation.

**3.2.13.6.2** The same formula shall be utilized for calculation of  $A$  for the open superstructure but  $l_t$  is used as an assumed length. The area just obtained shall be multiplied by the factor  $(b_0/l_t)/(1 - (l_w/l_t)^2)$  to adjust the freeing port area for the breadth  $b_0$  of the opening in the bulkhead between the superstructure and the well and the relationship of well and superstructure lengths. The area corrected in compliance with 3.2.13.2 is the freeing port area for the open superstructure on the freeboard deck.

**3.2.13.6.3** Where the open superstructure and the well are located in position 2, the areas thus obtained shall be multiplied by the factor

$$0,5h_{st}/h_w$$

where  $h_{st}$  = standard height of the superstructure;  
 $h_w$  = distance of the well deck above the freeboard deck.

**3.2.13.7** The lower edges of the freeing ports in a bulwark and passageways specified in 3.2.13.5 shall be as near the deck as practicable. Two-thirds of the freeing port and passageway area required shall be provided in the half of the well length nearest the lowest point of the sheer curve. In ships with no sheer in way of the wells the freeing port and passageway area shall be uniformly spread along the length of the wells.

**3.2.13.8** The freeing port openings in the bulwark shall be protected by guard rails or bars spaced approximately 230 mm apart. If shutters are fitted to freeing ports, ample clearance shall be provided to prevent jamming. Hinges shall have pins or bearings of non-corrodible material. If shutters are fitted with securing appliances, these appliances shall be of construction approved by the Register.

**3.2.14 Non-weathertight hatch covers above superstructure deck.**

**3.2.14.1** Non-weathertight hatch covers may be used on container ships.

**3.2.14.2** Such hatch covers may be fitted to cargo hatchways located on weather decks which are at least two standard superstructure heights above an actual freeboard deck or an assumed freeboard deck to which the minimum freeboard less than or equal to the freeboard actually assigned corresponds. Where a hatchway or a part thereof is forward of a point located one quarter of the ship length ( $0,25L$ ) from the forward perpendicular, that hatchway shall be located on a weather deck at least three standard superstructure heights above the actual or assumed freeboard deck. The assumed freeboard deck is used only for the purpose of measuring the height of the deck on which hatchways are situated and may be an imaginary, or virtual deck.

**3.2.14.3** Hatchway comings shall be not less than 600 mm in height.

**3.2.14.4** Non-weathertight gaps between hatch cover panels shall be considered as unprotected openings with respect to the requirements of intact and damage stability calculations. The gaps shall be as small as possible and, as a rule, shall not exceed 50 mm.

**3.2.14.5** Labyrinths, gutter bars, or equivalents shall be fitted proximate to the edges of each panel in way of gaps to minimize the amount of water that can enter in the hold from the top surface of each panel.

**3.2.14.6** Scantlings of hatch cover panels as well as details on securing arrangements shall be equivalent to those for weathertight covers determined in accordance with 7.10, Part III "Equipment, Arrangements and Outfit" of the Rules for the Classification and Construction of Sea-Going Ships. For the cover components, corrosion additions specified in 3.2.5.3.4 are applicable.

**3.2.14.7** If a fixed gas fire extinguishing system is fitted in the hold, the capacity of the system shall be increased by 10 per cent over that for the same vessel

with weathertight hatch covers, provided gaps between hatches are not more than 50 mm. Alternatively, a fixed pressure water-spraying system shall be provided.

**3.2.14.8** The bilge system for cargo holds with non-weathertight hatches shall have sufficient additional capacity for water ingress based on a steady rainfall of 100 mm/h applied through the total area of gaps between panels or the capacity of the sprinkler system where fitted, whichever is the greater.

The inner diameter of the bilge main shall be in accordance with the increased bilge pump capacity. Bilge alarms shall be provided in each cargo hold fitted with non-weathertight covers.

**3.12.14.9** Container holds fitted with non-weathertight hatch covers on ships intended to carry dangerous goods shall be considered as open-top container holds with respect to stowage and compatibility of dangerous goods.

**3.2.15 Spurling pipes and cable lockers.**

**3.2.15.1** Spurling pipes and cable lockers shall be watertight up to and including the weather deck.

**3.2.15.2** Access openings to cable lockers shall be closed by substantial covers secured by closely spaced bolts.

**3.2.15.3** Spurling pipes through which anchor cables are led shall be fitted with permanently attached closing appliances to minimize water ingress.

### 3.3 PROTECTION OF THE CREW

**3.3.1 Guard rails and bulwarks.**

Efficient guard rails or bulwarks shall be fitted on all exposed parts of the freeboard deck and the decks of superstructures, trunks and deckhouses.

The height of the bulwarks or guard rails shall be at least 1 m from the deck. However, where this height would interfere with the normal operation of the ship, a lesser height may be approved if the Register is satisfied that adequate protection is provided.

The opening below the lowest course of the guard rails shall not exceed 230 mm. The other courses shall be not more than 380 mm apart. In the case of ships with rounded gunwales, the guard rail supports shall be placed on the flat of the deck.

**3.3.2 Means of access.**

The protection of crew in getting to and from their quarters, the engine room and all other parts used in the necessary work of the ship shall be provided by at least one of the means of access denoted in Table 3.3.2 depending on the ship type and the assigned summer freeboard.

Acceptable arrangements referred to in Table 3.3.2 are defined as follows:

*a* — a well lighted and ventilated underdeck passageway (clear opening 0,8 m wide, 2,0 m high) as

Table 3.3.2

| Type of ship   | Locations of access in ship   | Assigned summer freeboard, in mm                    | Acceptable arrangements according to type of ship*                            |   |   |   |
|--|---|---|---|---|---|---|
|  |   |   | Type A  | Type B-100  | Type B-60   | Type B, B+  |
| 1. All ships other than oil tankers, chemical tankers and gas carriers | <b>1.1 Access to midship quarters</b><br>1.1.1 Between poop and bridge, or<br>1.1.2 Between poop and deck-house containing living accommodation and/or navigating equipment   | ≤ 3000  | <i>a</i><br><i>b</i><br><i>e</i>  | <i>a</i><br><i>b</i><br><i>e</i>  | <i>a, b, c(1)</i><br><i>e</i><br><i>f(1)</i>  | <i>a</i><br><i>b</i><br><i>c(1)</i><br><i>c(2)</i><br><i>c(4)</i><br><i>d(1)</i><br><i>d(2)</i><br><i>d(3)</i><br><i>e</i><br><i>f(1)</i><br><i>f(2)</i><br><i>f(4)</i> |
|  |   | > 3000  | <i>a</i><br><i>b</i><br><i>e</i>  | <i>a</i><br><i>b</i><br><i>e</i>  | <i>a, b</i><br><i>c(1), c(2)</i><br><i>e</i><br><i>f(1), f(2)</i>   |   |
|  | 1.2 Access to ends<br>1.2.1 Between poop and bow (if there is no bridge)<br>1.2.2 Between bridge and bow, or<br>1.2.3 Between deckhouse containing living accommodation and/or navigating equipment and bow, or<br>1.2.4 In flush deck vessel, between crew accommodation and forward or after ends of ship | ≤ 3000  | <i>a</i><br><i>b</i><br><i>c(1)</i><br><i>e</i><br><i>f(1)</i>                | <i>a</i><br><i>b</i><br><i>c(1), c(2)</i><br><i>e</i><br><i>f(1), f(2)</i>                      | <i>a</i><br><i>b</i><br><i>c(1), c(2)</i><br><i>e</i><br><i>f(1), f(2)</i>  |   |
|  |   | > 3000  | <i>a</i><br><i>b</i><br><i>c(1)</i><br><i>d(1)</i><br><i>e</i><br><i>f(1)</i> | <i>a</i><br><i>b</i><br><i>c(1), c(2)</i><br><i>d(1), d(2)</i><br><i>e</i><br><i>f(1), f(2)</i> | <i>a</i><br><i>b</i><br><i>c(1), c(2), c(4)</i><br><i>d(1), d(2), d(4)</i><br><i>e</i><br><i>f(1), f(2), f(4)</i> |   |
| 2. Oil tankers, chemical tankers and gas carriers                      | <b>2.1 Access to bow</b><br>2.1.1 Between poop and bow, or<br>2.1.2 Between a deckhouse containing living accommodation and/or navigating equipment and bow<br>2.1.3 In flush deck vessel, between crew accommodation and the forward ends of ship  | ≤ ( <i>A<sub>f</sub></i> + <i>h<sub>s</sub></i> )** | <i>e</i><br><i>f(1)</i><br><i>f(5)</i>  |   |   |   |
|  |   | > ( <i>A<sub>f</sub></i> + <i>h<sub>s</sub></i> )** | <i>a</i><br><i>e</i><br><i>f(1)</i><br><i>f(2)</i>                            |   |   |   |
|  | <b>2.2 Access to after end</b><br>2.2.1 In flush deck vessel, between crew accommodation and the after end of ship  | As required in 1.2.4 for other types of ships       |   |   |   |   |

\* Type of ship depending on the freeboard value is defined in the following paragraphs of 4.1: A-4.1.2, B-4.1.3, B-60-4.1.3.4, B-100-4.1.3.5, B+ — 4.1.3.6.  
\*\* *A<sub>f</sub>* is the minimum summer freeboard of type A ship; *h<sub>s</sub>* is the standard height of superstructure.

close as practicable to the freeboard deck, connecting and providing access to the locations in question;

*b* — a permanent and efficiently constructed gangway fitted at or above the level of superstructure deck on or as near as practicable to the center line of the ship, providing a continuous platform of at least 0,6 m in width with a non-slip surface, with guard rails extending on each side throughout its length. Guard rails shall be of at least 1 m high with courses as required in 3.3.1, and supported by stanchions spaced not more than 1,5 m apart; a foot-stop shall be provided;

*c* — a permanent passageway of at least 0,6 m in width fitted at freeboard deck level consisting of two rows of guard rails complying with the requirements of 3.3.1, with stanchions spaced not more than 3 m apart. On type B ships hatchway coamings of not less than 0,6 m in height may be regarded as forming one side of the passageway, provided that two rows of guard rails are fitted between hatchways;

*d* — a 10 mm minimum diameter wire rope lifeline supported by stanchions spaced about 10 m apart, or a single hand rail or wire rope attached to hatch coamings, continued and adequately supported between hatchways;

*e* — a permanent and efficiently constructed gangway fitted at or above the level of the superstructure deck on or as near as practicable to the center line of the ship, and:

located so as not to hinder easy access across the working areas of the deck;

providing a continuous platform of at least 1,0 m in width (for oil tankers of less than 100 m in length, and of at least 0,6 m in width);

constructed of fire resistant and non-slip material; fitted with guard rails of at least 1,0 m in high supported by stanchions spaced not more than 1,5 m apart and complying with the requirements of 3.3.1; provided with a foot-stop on each side;

having openings to and from the deck, with ladders where appropriate, which shall not be spaced more than 40 m apart;

having shelters of substantial construction set in way of the gangway at intervals not exceeding 45 m if the length of the exposed deck to be traversed exceeds 70 m. Every such shelter shall be capable of accommodating at least one person and be constructed so as to afford weather protection on the forward, port and starboard sides;

*f* — a permanent and efficiently constructed passageway fitted at freeboard deck level or as near as practicable to the center line of the ship having the same specifications as those for a permanent gangway listed in (e) except for foot-stops. On type B ships (certified for the carriage of liquid cargoes), with a combined height of hatch coaming and fitted hatch cover together not less than 1 m, hatchway coamings may be regarded as forming one side of the passageway, provided that between hatchways two rows of guard rails are fitted.

Where necessary, alternative transverse locations for (c), (d) and (f) may be the following:

- (1) fitted at the center line of the ship or near to it (on deck or on hatch covers);
- (2) fitted on each side of the ship;
- (3) fitted on one side of the ship, provision being made for fitting on either side;
- (4) fitted on one side only;
- (5) fitted on each side of hatchways as near to the center line as practicable.

**Notes:**

1. In all cases where wire ropes are fitted, the adequate devices shall be provided to ensure their tautness.
2. Wire ropes may be accepted instead of guard rails only in special cases and then only in limited lengths.
3. Lengths of chain may be accepted instead of guard rails only if fitted between two fixed stanchions.
4. Where stanchions are fitted, every third stanchion shall be supported by a bracket or stay.
5. Removable or hinged stanchions shall be capable of being locked in the upright position.
6. A possibility of passage over obstructions, if any, such as pipes or other permanent fittings shall be provided.
7. As a rule, the width of the gangway or deck-level passageway is not to exceed 1,5 m.

### 3.3.3 Deck cargo stowage.

Deck cargo carried on any ship shall be so stowed that any opening which is in way of the cargo and which gives access to and from the crew's quarters, the engine room and all other parts used in the necessary work of the ship, can be properly closed and secured against the admission of water. Effective protection for the crew in the form of guard rails or life lines shall be provided above the deck cargo if

there are no convenient passages on or below the deck of the ship.

## 3.4 SPECIAL CONDITIONS OF ASSIGNMENT FOR TYPE A SHIPS

### 3.4.1 Machinery casings.

Machinery casings on type A ships as defined in 4.1.2.1 shall be protected by an enclosed poop or bridge of at least standard height, or by a deckhouse of equal height and equivalent strength. Machinery casings may be exposed if there are no openings in them giving direct access from the freeboard deck to the engine room. A door complying with the appropriate requirements of 3.2.2.1 and having a sill not less than 600 mm in height if in position 1 and not less than 380 mm in height if in position 2 may, however, be permitted in the machinery casing, provided that it leads to a space or passageway which is as strongly constructed as the casing and is separated from the stairway to the engine room by a second weathertight door of steel or other equivalent material with a sill not less than 230 mm in height.

### 3.4.2 Gangway and means of access.

Gangways and means of access shall comply with the requirements of Table 3.3.2 having regard to the type of ship and the summer freeboard.

### 3.4.3 Hatchways.

Exposed hatchways in position 1 and on the tops of expansion trunks on type A ships shall be provided with efficient watertight covers of steel or other equivalent material.

### 3.4.4 Freeing arrangements.

Type A ships with bulwarks shall generally have open rails fitted for at least half the length of the exposed parts of the weather deck. If the continuous bulwark is fitted, the area of freeing ports in the lower part of the bulwark shall not be less than 33 per cent of its total area. The upper edge of the sheer strake shall be kept as low as practicable.

Where superstructures are connected by trunks, open rails shall be fitted for the whole length of the exposed parts of the freeboard deck. Where the height of bounding coamings fitted on the deck to prevent oil from spillage during cargo handling operations is more than 300 mm, freeing ports complying with the requirements of 3.2.13 shall be arranged therein. Freeing port covers shall be stowed and secured when at sea so that not to interfere with drainage of the decks.

## 4 ASSIGNMENT OF MINIMUM FREEBOARDS FOR SHIPS ENGAGED IN INTERNATIONAL VOYAGES

### 4.1 TYPES OF SHIPS AND FREEBOARD TABLES

**4.1.1** For the purposes of freeboard calculation ships shall be divided into type A and type B.

#### 4.1.2 Type A ships.

**4.1.2.1** A type A ship is one which:

is designed to carry only liquid cargoes in bulk; has a high integrity of the exposed deck with only small access openings to cargo compartments closed by watertight gasketed covers of steel or equivalent material; and

has low permeability of loaded cargo compartments.

**4.1.2.2** A type A ship (other than oil tanker, chemical tanker and gas carrier) if over 150 m in length, to which a freeboard less than type B has been assigned, when loaded to its summer load waterline, shall be capable to withstand the flooding of any one compartment. In this case an assumed permeability shall be as follows:

0,95 for any floodable compartments and spaces (except for engine room);

0,85 for floodable engine room.

For oil tankers, chemical tankers and gas carriers the requirements of Section 3, Part V "Subdivision" of Rules for the Classification and Construction of Sea-Going Ships shall be met.

**4.1.2.3** A type A ship shall be assigned a freeboard not less than that based on Table 4.1.2.3.

#### 4.1.3 Type B ships.

**4.1.3.1** All ships which do not come within the provisions regarding type A ships in 4.1.2.1 and 4.1.2.2 shall be considered as type B ships.

**4.1.3.2** Type B ships, which in position 1 have hatchways fitted with hatch covers complying with the requirements of 3.2.5 shall, other than 3.2.5.4, and unless provisions of 4.1.3.3 to 4.1.3.5 are applied, be assigned freeboards not less than those based on Table 4.1.3.2.

**4.1.3.3** The Register may sanction the assignment of a lesser freeboard than that required under 4.1.3.2 to any type B ship over 100 m in length, provided that, in relation to the amount of reduction granted, the following conditions are maintained:

**.1** the measures provided for protection of the crew comply with the requirements of 3.3.2 specified for the B-60 type ships;

**.2** the freeing arrangements comply with the requirements of 3.2.13. The area of the freeing ports in the bulwark forming wells in the freeboard deck is not to be less than 25 per cent of the total area of the bulwark;

**.3** the hatch covers in positions 1 and 2 comply with the requirements of 3.2.5, other than 3.2.5.4 special care being given to their sealing and securing arrangements.

Hatch covers on ships intended for the carriage of bulk cargoes shall also comply with the requirements of 7.14, Part III "Arrangements, Equipment and Outfit" of Rules for the Classification and Construction of Sea-Going Ships;

**.4** the ship, when loaded to her summer load waterline, will remain afloat in a satisfactory condition of equilibrium after flooding of any single damaged compartment at an assumed permeability of 0,95, excluding the engine room. Such a ship, if over 150 m in length, shall withstand the flooding of the engine room, taken alone with a coefficient of permeability of 0,85.

**4.1.3.4** In calculating the freeboards for type B ships which comply with the requirements of 4.1.3.3, the values from Table 4.1.3.2 shall not be reduced by more than 60 per cent of the difference between the tabular values given in 4.1.3.2 and those given in 4.1.2.3 for the appropriate ship lengths.

**4.1.3.5** The reduction in tabular freeboard allowed under 4.1.3.4 may be increased up to the total difference between the values in Table 4.1.3.2 and those in Table 4.1.2.3 on condition that the ship complies with the requirements of 3.4.1, 3.4.2 and 3.4.4, as if it were a type A ship, and further complies with the provisions of 4.1.3.3.1 to 4.1.3.3.4, except that the reference in 4.1.3.3.4 to the flooding of any single damaged compartment shall be treated as a reference to the flooding of any two adjacent fore and aft compartments, neither of which is the engine room.

Also any such ship of 150 m in length and over, when loaded to her summer load waterline, shall remain afloat in a satisfactory condition of equilibrium after flooding of the engine room taken alone.

**4.1.3.6** Type B ships, which in position 1 have hatchways fitted with hatch covers which comply with the requirements of 3.2.4, other than 3.2.4.7 or which are fitted with securing arrangements accepted under 3.2.5.4, shall be assigned freeboards based upon the values given in Table 4.1.3.2 increased by the values given in Table 4.1.3.6.

#### 4.1.4 Non-self-propelled ships.

A lighter, barge or other non-self-propelled ships shall be assigned a freeboard in accordance with the provisions of these Rules. However, in the case of



Table 4.1.2.3

## Tabular freeboard for type A ships

| Length of ship, m | Freeboard, mm | Length of ship, m | Freeboard, mm | Length of ship, m | Freeboard, mm | Length of ship, m | Freeboard, mm |
|-------------------|---------------|-------------------|---------------|-------------------|---------------|-------------------|---------------|
| 24                | 200           | 88                | 955           | 152               | 2000          | 216               | 2758          |
| 25                | 208           | 89                | 969           | 153               | 2016          | 217               | 2767          |
| 26                | 217           | 90                | 984           | 154               | 2032          | 218               | 2775          |
| 27                | 225           | 91                | 999           | 155               | 2048          | 219               | 2784          |
| 28                | 233           | 92                | 1014          | 156               | 2064          | 220               | 2792          |
| 29                | 242           | 93                | 1029          | 157               | 2080          | 221               | 2801          |
| 30                | 250           | 94                | 1044          | 158               | 2096          | 222               | 2809          |
| 31                | 258           | 95                | 1059          | 159               | 2111          | 223               | 2817          |
| 32                | 267           | 96                | 1074          | 160               | 2126          | 224               | 2825          |
| 33                | 275           | 97                | 1089          | 161               | 2141          | 225               | 2833          |
| 34                | 283           | 98                | 1105          | 162               | 2155          | 226               | 2841          |
| 35                | 292           | 99                | 1120          | 163               | 2169          | 227               | 2849          |
| 36                | 300           | 100               | 1135          | 164               | 2184          | 228               | 2857          |
| 37                | 308           | 101               | 1151          | 165               | 2198          | 229               | 2865          |
| 38                | 316           | 102               | 1166          | 166               | 2212          | 230               | 2872          |
| 39                | 325           | 103               | 1181          | 167               | 2226          | 231               | 2880          |
| 40                | 334           | 104               | 1196          | 168               | 2240          | 232               | 2888          |
| 41                | 344           | 105               | 1212          | 169               | 2254          | 233               | 2895          |
| 42                | 354           | 106               | 1228          | 170               | 2268          | 234               | 2903          |
| 43                | 364           | 107               | 1244          | 171               | 2281          | 235               | 2910          |
| 44                | 374           | 108               | 1260          | 172               | 2294          | 236               | 2918          |
| 45                | 385           | 109               | 1276          | 173               | 2307          | 237               | 2925          |
| 46                | 396           | 110               | 1293          | 174               | 2320          | 238               | 2932          |
| 47                | 408           | 111               | 1309          | 175               | 2332          | 239               | 2939          |
| 48                | 420           | 112               | 1326          | 176               | 2345          | 240               | 2946          |
| 49                | 432           | 113               | 1342          | 177               | 2357          | 241               | 2953          |
| 50                | 443           | 114               | 1359          | 178               | 2369          | 242               | 2959          |
| 51                | 455           | 115               | 1376          | 179               | 2381          | 243               | 2966          |
| 52                | 467           | 116               | 1392          | 180               | 2393          | 244               | 2973          |
| 53                | 478           | 117               | 1409          | 181               | 2405          | 245               | 2979          |
| 54                | 490           | 118               | 1426          | 182               | 2416          | 246               | 2986          |
| 55                | 503           | 119               | 1442          | 183               | 2428          | 247               | 2993          |
| 56                | 516           | 120               | 1459          | 184               | 2440          | 248               | 3000          |
| 57                | 530           | 121               | 1476          | 185               | 2451          | 249               | 3006          |
| 58                | 544           | 122               | 1494          | 186               | 2463          | 250               | 3012          |
| 59                | 559           | 123               | 1511          | 187               | 2474          | 251               | 3018          |
| 60                | 573           | 124               | 1528          | 188               | 2485          | 252               | 3024          |
| 61                | 587           | 125               | 1546          | 189               | 2497          | 253               | 3030          |
| 62                | 600           | 126               | 1563          | 190               | 2508          | 254               | 3036          |
| 63                | 613           | 127               | 1580          | 191               | 2519          | 255               | 3042          |
| 64                | 626           | 128               | 1598          | 192               | 2530          | 256               | 3048          |
| 65                | 639           | 129               | 1615          | 193               | 2541          | 257               | 3054          |
| 66                | 653           | 130               | 1632          | 194               | 2552          | 258               | 3060          |
| 67                | 666           | 131               | 1650          | 195               | 2562          | 259               | 3066          |
| 68                | 680           | 132               | 1667          | 196               | 2572          | 260               | 3072          |
| 69                | 693           | 133               | 1684          | 197               | 2582          | 261               | 3078          |
| 70                | 706           | 134               | 1702          | 198               | 2592          | 262               | 3084          |
| 71                | 720           | 135               | 1719          | 199               | 2602          | 263               | 3089          |
| 72                | 733           | 136               | 1736          | 200               | 2612          | 264               | 3095          |
| 73                | 746           | 137               | 1753          | 201               | 2622          | 265               | 3101          |
| 74                | 760           | 138               | 1770          | 202               | 2632          | 266               | 3106          |
| 75                | 773           | 139               | 1787          | 203               | 2641          | 267               | 3112          |
| 76                | 786           | 140               | 1803          | 204               | 2650          | 268               | 3117          |
| 77                | 800           | 141               | 1820          | 205               | 2659          | 269               | 3123          |
| 78                | 814           | 142               | 1837          | 206               | 2669          | 270               | 3128          |
| 79                | 828           | 143               | 1853          | 207               | 2678          | 271               | 3133          |
| 80                | 841           | 144               | 1870          | 208               | 2687          | 272               | 3138          |
| 81                | 855           | 145               | 1886          | 209               | 2696          | 273               | 3143          |
| 82                | 869           | 146               | 1903          | 210               | 2705          | 274               | 3148          |
| 83                | 883           | 147               | 1919          | 211               | 2714          | 275               | 3153          |
| 84                | 897           | 148               | 1935          | 212               | 2723          | 276               | 3158          |
| 85                | 911           | 149               | 1952          | 213               | 2732          | 277               | 3163          |
| 86                | 926           | 150               | 1968          | 214               | 2741          | 278               | 3167          |
| 87                | 940           | 151               | 1984          | 215               | 2749          | 279               | 3172          |

Table 4.1.2.3 — continued

| Length of ship, m | Freeboard, mm | Length of ship, m | Freeboard, mm | Length of ship, m | Freeboard, mm | Length of ship, m | Freeboard, mm |
|-------------------|---------------|-------------------|---------------|-------------------|---------------|-------------------|---------------|
| 280               | 3176          | 302               | 3270          | 324               | 3342          | 346               | 3396          |
| 281               | 3181          | 303               | 3274          | 325               | 3345          | 347               | 3399          |
| 282               | 3185          | 304               | 3278          | 326               | 3347          | 348               | 3401          |
| 283               | 3189          | 305               | 3281          | 327               | 3350          | 349               | 3403          |
| 284               | 3194          | 306               | 3285          | 328               | 3353          | 350               | 3406          |
| 285               | 3198          | 307               | 3288          | 329               | 3355          | 351               | 3408          |
| 286               | 3202          | 308               | 3292          | 330               | 3358          | 352               | 3410          |
| 287               | 3207          | 309               | 3295          | 331               | 3361          | 353               | 3412          |
| 288               | 3211          | 310               | 3298          | 332               | 3363          | 354               | 3414          |
| 289               | 3215          | 311               | 3302          | 333               | 3366          | 355               | 3416          |
| 290               | 3220          | 312               | 3305          | 334               | 3368          | 356               | 3418          |
| 291               | 3224          | 313               | 3308          | 335               | 3371          | 357               | 3420          |
| 292               | 3228          | 314               | 3312          | 336               | 3373          | 358               | 3422          |
| 293               | 3233          | 315               | 3315          | 337               | 3375          | 359               | 3423          |
| 294               | 3237          | 316               | 3318          | 338               | 3378          | 360               | 3425          |
| 295               | 3241          | 317               | 3322          | 339               | 3380          | 361               | 3427          |
| 296               | 3246          | 318               | 3325          | 340               | 3382          | 362               | 3428          |
| 297               | 3250          | 319               | 3328          | 341               | 3385          | 363               | 3430          |
| 298               | 3254          | 320               | 3331          | 342               | 3387          | 364               | 3432          |
| 299               | 3258          | 321               | 3334          | 343               | 3389          | 365               | 3433          |
| 300               | 3262          | 322               | 3337          | 344               | 3392          |                   |               |
| 301               | 3266          | 323               | 3339          | 345               | 3394          |                   |               |

No t e . Freeboards at intermediate lengths of ship shall be obtained by linear interpolation.  
Freeboards, in mm, for ships with lengths between 365 and 400 m shall be determined by the following formula:  
 $16,10L - 0,02L^2 + 221$ .  
Freeboards for ships with lengths 400 m and above shall be the constant value 3460 mm.

Table 4.1.3.2

## Tabular freeboard for type B ships

| Length of ship, m | Freeboard, mm | Length of ship, m | Freeboard, mm | Length of ship, m | Freeboard, mm | Length of ship, m | Freeboard, mm |
|-------------------|---------------|-------------------|---------------|-------------------|---------------|-------------------|---------------|
| 24                | 200           | 53                | 478           | 82                | 923           | 111               | 1500          |
| 25                | 208           | 54                | 490           | 83                | 942           | 112               | 1521          |
| 26                | 217           | 55                | 503           | 84                | 960           | 113               | 1543          |
| 27                | 225           | 56                | 516           | 85                | 978           | 114               | 1565          |
| 28                | 233           | 57                | 530           | 86                | 996           | 115               | 1587          |
| 29                | 242           | 58                | 544           | 87                | 1015          | 116               | 1609          |
| 30                | 250           | 59                | 559           | 88                | 1034          | 117               | 1630          |
| 31                | 258           | 60                | 573           | 89                | 1054          | 118               | 1651          |
| 32                | 267           | 61                | 587           | 90                | 1075          | 119               | 1671          |
| 33                | 275           | 62                | 601           | 91                | 1096          | 120               | 1690          |
| 34                | 283           | 63                | 615           | 92                | 1116          | 121               | 1709          |
| 35                | 292           | 64                | 629           | 93                | 1135          | 122               | 1729          |
| 36                | 300           | 65                | 644           | 94                | 1154          | 123               | 1750          |
| 37                | 308           | 66                | 659           | 95                | 1172          | 124               | 1771          |
| 38                | 316           | 67                | 674           | 96                | 1190          | 125               | 1793          |
| 39                | 325           | 68                | 689           | 97                | 1209          | 126               | 1815          |
| 40                | 334           | 69                | 705           | 98                | 1229          | 127               | 1837          |
| 41                | 344           | 70                | 721           | 99                | 1250          | 128               | 1859          |
| 42                | 354           | 71                | 738           | 100               | 1271          | 129               | 1880          |
| 43                | 364           | 72                | 754           | 101               | 1293          | 130               | 1901          |
| 44                | 374           | 73                | 769           | 102               | 1315          | 131               | 1921          |
| 45                | 385           | 74                | 784           | 103               | 1337          | 132               | 1940          |
| 46                | 396           | 75                | 800           | 104               | 1359          | 133               | 1959          |
| 47                | 408           | 76                | 816           | 105               | 1380          | 134               | 1979          |
| 48                | 420           | 77                | 833           | 106               | 1401          | 135               | 2000          |
| 49                | 432           | 78                | 850           | 107               | 1421          | 136               | 2021          |
| 50                | 443           | 79                | 868           | 108               | 1440          | 137               | 2043          |
| 51                | 455           | 80                | 887           | 109               | 1459          | 138               | 2065          |
| 52                | 467           | 81                | 905           | 110               | 1479          | 139               | 2087          |

Table 4.1.3.2 — continued

| Length of ship, m | Freeboard, mm | Length of ship, m | Freeboard, mm | Length of ship, m | Freeboard, mm | Length of ship, m | Freeboard, mm |
|-------------------|---------------|-------------------|---------------|-------------------|---------------|-------------------|---------------|
| 140               | 2109          | 197               | 3219          | 254               | 4072          | 311               | 4748          |
| 141               | 2130          | 198               | 3235          | 255               | 4085          | 312               | 4757          |
| 142               | 2151          | 199               | 3249          | 256               | 4098          | 313               | 4768          |
| 143               | 2171          | 200               | 3264          | 257               | 4112          | 314               | 4779          |
| 144               | 2190          | 201               | 3280          | 258               | 4125          | 315               | 4790          |
| 145               | 2209          | 202               | 3296          | 259               | 4139          | 316               | 4801          |
| 146               | 2229          | 203               | 3313          | 260               | 4152          | 317               | 4812          |
| 147               | 2250          | 204               | 3330          | 261               | 4165          | 318               | 4823          |
| 148               | 2271          | 205               | 3347          | 262               | 4177          | 319               | 4834          |
| 149               | 2293          | 206               | 3363          | 263               | 4189          | 320               | 4844          |
| 150               | 2315          | 207               | 3380          | 264               | 4201          | 321               | 4855          |
| 151               | 2334          | 208               | 3397          | 265               | 4214          | 322               | 4866          |
| 152               | 2354          | 209               | 3413          | 266               | 4227          | 323               | 4878          |
| 153               | 2375          | 210               | 3430          | 267               | 4240          | 324               | 4890          |
| 154               | 2396          | 211               | 3445          | 268               | 4252          | 325               | 4899          |
| 155               | 2418          | 212               | 3460          | 269               | 4264          | 326               | 4909          |
| 156               | 2440          | 213               | 3475          | 270               | 4276          | 327               | 4920          |
| 157               | 2460          | 214               | 3490          | 271               | 4289          | 328               | 4931          |
| 158               | 2480          | 215               | 3505          | 272               | 4302          | 329               | 4943          |
| 159               | 2500          | 216               | 3520          | 273               | 4315          | 330               | 4955          |
| 160               | 2520          | 217               | 3537          | 274               | 4327          | 331               | 4965          |
| 161               | 2540          | 218               | 3554          | 275               | 4339          | 332               | 4975          |
| 162               | 2560          | 219               | 3570          | 276               | 4350          | 333               | 4985          |
| 163               | 2580          | 220               | 3586          | 277               | 4362          | 334               | 4995          |
| 164               | 2600          | 221               | 3601          | 278               | 4373          | 335               | 5005          |
| 165               | 2620          | 222               | 3615          | 279               | 4385          | 336               | 5015          |
| 166               | 2640          | 223               | 3630          | 280               | 4397          | 337               | 5025          |
| 167               | 2660          | 224               | 3645          | 281               | 4408          | 338               | 5035          |
| 168               | 2680          | 225               | 3660          | 282               | 4420          | 339               | 5045          |
| 169               | 2698          | 226               | 3675          | 283               | 4432          | 340               | 5055          |
| 170               | 2716          | 227               | 3690          | 284               | 4443          | 341               | 5065          |
| 171               | 2735          | 228               | 3705          | 285               | 4455          | 342               | 5075          |
| 172               | 2754          | 229               | 3720          | 286               | 4467          | 343               | 5086          |
| 173               | 2774          | 230               | 3735          | 287               | 4478          | 344               | 5097          |
| 174               | 2795          | 231               | 3750          | 288               | 4490          | 345               | 5108          |
| 175               | 2815          | 232               | 3765          | 289               | 4502          | 346               | 5119          |
| 176               | 2835          | 233               | 3780          | 290               | 4513          | 347               | 5130          |
| 177               | 2855          | 234               | 3795          | 291               | 4525          | 348               | 5140          |
| 178               | 2875          | 235               | 3808          | 292               | 4537          | 349               | 5150          |
| 179               | 2895          | 236               | 3821          | 293               | 4548          | 350               | 5160          |
| 180               | 2915          | 237               | 3835          | 294               | 4560          | 351               | 5170          |
| 181               | 2933          | 238               | 3849          | 295               | 4572          | 352               | 5180          |
| 182               | 2952          | 239               | 3864          | 296               | 4583          | 353               | 5190          |
| 183               | 2970          | 240               | 3880          | 297               | 4595          | 354               | 5200          |
| 184               | 2988          | 241               | 3893          | 298               | 4607          | 355               | 5210          |
| 185               | 3007          | 242               | 3906          | 299               | 4618          | 356               | 5220          |
| 186               | 3025          | 243               | 3920          | 300               | 4630          | 357               | 5230          |
| 187               | 3044          | 244               | 3934          | 301               | 4642          | 358               | 5240          |
| 188               | 3062          | 245               | 3949          | 302               | 4654          | 359               | 5250          |
| 189               | 3080          | 246               | 3965          | 303               | 4665          | 360               | 5260          |
| 190               | 3098          | 247               | 3978          | 304               | 4676          | 361               | 5268          |
| 191               | 3116          | 248               | 3992          | 305               | 4686          | 362               | 5276          |
| 192               | 3134          | 249               | 4005          | 306               | 4695          | 363               | 5285          |
| 193               | 3151          | 250               | 4018          | 307               | 4704          | 364               | 5294          |
| 194               | 3167          | 251               | 4032          | 308               | 4714          | 365               | 5303          |
| 195               | 3185          | 252               | 4045          | 309               | 4725          |                   |               |
| 196               | 3202          | 253               | 4058          | 310               | 4736          |                   |               |

Note. Freeboards at intermediate lengths of ship shall be obtained by linear interpolation.  
Freeboards for ships with lengths between 365 and 400 m shall be determined by the following formula:  $23L - 0,0188L^2 - 587$ .  
Freeboards for ships with lengths of 400 m and above shall be the constant value 5605 mm.

Table 4.1.3.6

Freeboard increase over tabular freeboard for type B ships with hatch covers complying with requirements of 3.2.4 (other than 3.2.4.7)

| Length of ship, m | Freeboard increase, mm | Length of ship, m | Freeboard increase, mm | Length of ship, m | Freeboard increase, mm | Length of ship, m | Freeboard increase, mm |
|-------------------|------------------------|-------------------|------------------------|-------------------|------------------------|-------------------|------------------------|
| 108 and less      | 50                     | 132               | 136                    | 156               | 251                    | 180               | 313                    |
| 109               | 52                     | 133               | 142                    | 157               | 254                    | 181               | 315                    |
| 110               | 55                     | 134               | 147                    | 158               | 258                    | 182               | 318                    |
| 111               | 57                     | 135               | 153                    | 159               | 261                    | 183               | 320                    |
| 112               | 59                     | 136               | 159                    | 160               | 264                    | 184               | 322                    |
| 113               | 62                     | 137               | 164                    | 161               | 267                    | 185               | 325                    |
| 114               | 64                     | 138               | 170                    | 162               | 270                    | 186               | 327                    |
| 115               | 68                     | 139               | 175                    | 163               | 273                    | 187               | 329                    |
| 116               | 70                     | 140               | 181                    | 164               | 275                    | 188               | 332                    |
| 117               | 73                     | 141               | 186                    | 165               | 278                    | 189               | 334                    |
| 118               | 76                     | 142               | 191                    | 166               | 280                    | 190               | 336                    |
| 119               | 80                     | 143               | 196                    | 167               | 283                    | 191               | 339                    |
| 120               | 84                     | 144               | 201                    | 168               | 285                    | 192               | 341                    |
| 121               | 87                     | 145               | 206                    | 169               | 287                    | 193               | 343                    |
| 122               | 91                     | 146               | 210                    | 170               | 290                    | 194               | 346                    |
| 123               | 95                     | 147               | 215                    | 171               | 292                    | 195               | 348                    |
| 124               | 99                     | 148               | 219                    | 172               | 294                    | 196               | 350                    |
| 125               | 103                    | 149               | 224                    | 173               | 297                    | 197               | 353                    |
| 126               | 108                    | 150               | 228                    | 174               | 299                    | 198               | 355                    |
| 127               | 112                    | 151               | 232                    | 175               | 301                    | 199               | 357                    |
| 128               | 116                    | 152               | 236                    | 176               | 304                    | 200               | 358                    |
| 129               | 121                    | 153               | 240                    | 177               | 306                    |                   |                        |
| 130               | 126                    | 154               | 244                    | 178               | 308                    |                   |                        |
| 131               | 131                    | 155               | 247                    | 179               | 311                    |                   |                        |

Note. Freeboard increase at intermediate lengths of ship shall be obtained by linear interpolation. Ships above 200 m in length shall be dealt with by the Register.

barges which are unmanned the requirements of 3.3, 3.4.2 and 4.4.8 shall not apply. Such unmanned barges which have on the freeboard deck only small access (not over 1,5 m<sup>2</sup>) openings closed by watertight gasketed covers of steel or other equivalent material may be assigned freeboards 25 per cent less than those calculated in accordance with these Rules. In this case, for the barges carrying the deck cargo, the above reduction is allowed only for the freeboard calculated as for ordinary type B ship.

Stability of barges with cargo on the weather deck is subject to special consideration by the Register.

Access plates, if provided by the design, shall be so designed that they have structural strength, integrity and watertightness equivalent to the deck plating. They shall be secured to the deck by closely spaced bolts.

#### 4.1.5 Calculations of flooding of compartments.

In carrying out calculations in compliance with 4.1.2.2, 4.1.3.3, 4.1.3.4 and 4.1.3.5 the requirements for initial trim and conditions of loading, damage extent and character of flooding, as well as conditions of equilibrium after flooding specified in Section 4 of Part V "Subdivision" of Rules for the Classification and Construction of Sea-Going Ships shall be met.

For oil tankers, chemical tankers and gas carriers the requirements of Section 3, Part V "Subdivision" of the above Rules shall be met.

## 4.2 SUPERSTRUCTURES AND TRUNKS

### 4.2.1 Standard height of superstructure.

The standard height of a superstructure shall be as given in Table 4.2.1.

Table 4.2.1

| Standard height, m |                        |                              |
|--------------------|------------------------|------------------------------|
| Length of ship, m  | Raised quarter deck, m | All other superstructures, m |
| 30 or less         | 0,9                    | 1,8                          |
| 75                 | 1,2                    | 1,8                          |
| 125 or more        | 1,8                    | 2,3                          |

Note. The standard height of superstructure at intermediate lengths of ships shall be obtained by linear interpolation.

### 4.2.2 Length of superstructure.

4.2.2.1 Except as provided in 4.2.2.2 and 4.2.2.3 the length of superstructure  $S$  shall be equal to the length of these parts of the superstructure which lie within the ship length  $L$ .

4.2.2.2 Where the end bulkhead of an enclosed superstructure is of a fair convex form the length of the superstructure may be increased on the basis of replacement of convex bulkhead by an equivalent plane bulkhead. This increase  $\Delta S$  shall be two-thirds of extent of the bulkhead curvature along the ship's length  $f$ . The maximum curvature which may be taken into account in determining this increase is

one-half the breadth of the superstructure at the point of intersection of the superstructure bulkhead with its side  $b_1$  (Fig. 4.2.2.2).

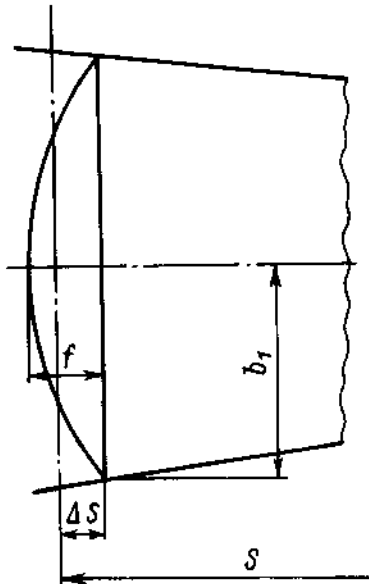

Fig. 4.2.2.2

**4.2.2.3** Where a superstructure bulkhead is recessed, the effective length of the superstructure shall be reduced by an amount equal to the area of the recess related to the breadth of the superstructure at the mid-length of the recess.

Where the recess is asymmetrical about the centre line, the largest portion of the recess shall be considered as applying to both sides of the ship.

Such a recess need not be decked over.

Where a cargo hatchway, complying with the requirements of 3.2.5 and having a coaming height that extends above the level of the superstructure deck, is fitted in the recess of the superstructure and covering the whole area of the recess, the hatchway may be taken into account as forming a part of the superstructure, and the effective length of the superstructure need not be reduced for recess. The hatchway coaming height measured from the superstructure deck level shall meet the requirements of 3.2.5.1.

Where there is an extension to a superstructure, which extension has a breadth on each side of the centre line at least 30 per cent of the breadth of the ship, the effective length of the superstructure may be increased in compliance with 4.2.2.2, considering an equivalent superstructure bulkhead in the form of a parabola. This parabola shall extend from the extension at the centre line and pass through the junction of the actual superstructure bulkhead with the sides of the extension and extend to the sides of the ship. This parabola shall be completely contained

within the boundary of the superstructure and its extensions (refer to Fig. 4.2.2.3.1).

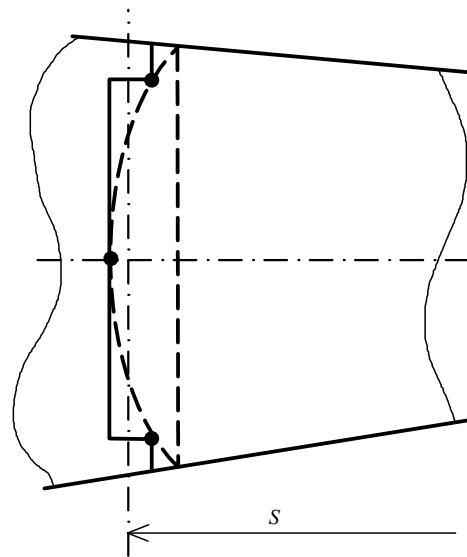

Fig. 4.2.2.3.1

Where a deckhouse adjacent to the end superstructure bulkhead is considered as the extension of it, the vertex of the above parabola may be not at the bulkhead extension, as specified above, but within the extension, on the assumption that the maximum curvature shall not exceed one-half the breadth of the superstructure at the point of intersection of the parabola with the superstructure sides (refer to Fig. 4.2.2.3.2).

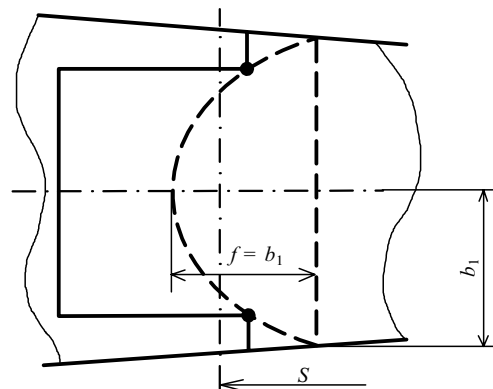

Fig. 4.2.2.3.2

**4.2.2.4** The length  $S$  of a superstructure which has a sloping end bulkhead shall be determined in the following manner:

.1 when the height of the superstructure, clear of the slope, is equal to or smaller than the standard height, its length  $S$  shall be obtained as shown in Fig. 4.2.2.4.1;

.2 when the height of the superstructure is greater than the standard, its length  $S$  shall be obtained as shown in Fig. 4.2.2.4.2;

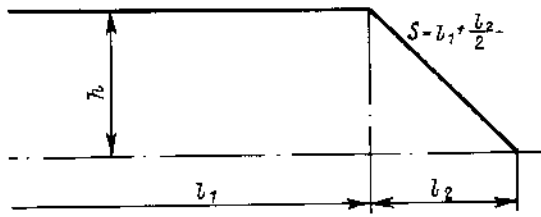

Fig. 4.2.2.4.1

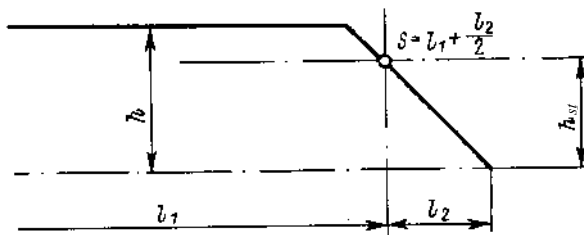

Fig. 4.2.2.4.2

.3 the foregoing will apply only when the slope related to the base line is  $15^\circ$  or greater. Where the slope is less than  $15^\circ$ , the construction shall be treated as sheer.

#### 4.2.3 Effective length of superstructure.

4.2.3.1 Except as provided in 4.2.3.2, the effective length ( $E$ ) of an enclosed superstructure of standard height shall be its length.

4.2.3.2 Where an enclosed superstructure of standard height is set in from the sides of the ship for a distance of up to  $0,04B$ , the effective length shall be the length modified by the ratio of the breadth of the superstructure at the middle of its length to the breadth of the ship in the same section.

Where a superstructure is set in for a part of its length, this modification shall be applied only to the set in part.

4.2.3.3 Where the height of an enclosed superstructure is less than the standard height, the effective length shall be its length reduced in the ratio of the actual height to the standard height. Where the height of the superstructure exceeds the standard, no increase shall be made to the effective length of the superstructure.

4.2.3.4 The effective length of a raised quarter deck, if it is of a height not less than standard and is fitted with an intact front bulkhead, shall be its actual length. Where the quarter deck height is less than standard, the effective length shall be its length reduced in the ratio of the actual height of the quarter deck to its standard height.

The effective length of the raised quarter deck may be taken into account only up to a maximum of  $0,6L$  from the after perpendicular. This relates also to

those cases when a poop is fitted in conjunction with the raised quarter deck.

Where the bulkhead of the raised quarter deck has openings capable of being secured weathertight, such quarter deck shall be treated as a poop of less than standard height. In a ship with a superstructure which extends over the whole length of the freeboard deck, the part of the superstructure from the after perpendicular up to a maximum of  $0,6L$  may be treated as a raised quarter deck. In this respect if no watertight front bulkhead is fitted at a distance of  $0,6L$  from the after perpendicular, the bow end superstructure bulkhead may be considered to act as such.

4.2.3.5 Superstructures which are not enclosed shall be omitted in calculation of the effective length.

#### 4.2.4 Trunks.

4.2.4.1 A trunk or similar structure which does not extend to the sides of the ship shall be regarded as efficient on the following conditions:

- .1 the trunk is at least as strong as a superstructure;
- .2 the hatchways are in the trunk deck, and the hatchway coamings and covers comply with the requirements of 3.2.1, 3.2.3, 3.2.4 and 3.2.5.

The sides of a trunk included in the calculation of freeboard shall be intact. Side scuttles of the non-opening type and bolted manhole covers may be allowed. The width of the trunk deck stringer provides a satisfactory gangway and sufficient lateral stiffness. Only small access openings fitted with watertight covers may be permitted in the exposed part of the freeboard deck in way of a trunk;

.3 a permanent working platform fore and aft fitted with guard rails is provided by the trunk deck, or by detached trunk decks connected to superstructures by efficient permanent gangways;

.4 ventilators are protected by the trunk and fitted with watertight covers or protected by other equivalent means;

.5 open rails are fitted on the weather parts of the freeboard deck in way of the trunk for at least half their length. If the continuous bulwark is fitted, the area of freeing ports in the lower part of the bulwark shall not be less than 33 per cent of its total area. The upper edge of the sheer strake shall be kept as low as practicable;

.6 the machinery casings are protected by the trunk, by a superstructure of at least standard height, or by a deckhouse of the same height and of equivalent strength;

.7 the breadth of the trunk is at least  $0,6B$ ;

.8 where there is no superstructure, the length of the trunk is at least  $0,6L$ .

4.2.4.2 In the freeboard calculation continuous hatchways may be treated as a trunk provided all the conditions specified in 4.2.4.1 are complied with.

The trunk deck stringer referred to in 4.2.4.1.2 may be fitted outboard the continuous hatchway coaming and shall be of solid plate efficiently supported and stiffened providing a clear walkway of at least 450 mm in width on each side of the ship.

The stringer shall be as high above the freeboard deck as practicable.

Hatch cover securing appliances shall be accessible from the stringer or walkway.

The breadth of the trunk shall be measured between the side hatchway coamings.

**4.2.4.3** Where the trunk adjoining the superstructures such as poop, bridge or forecastle is included in the freeboard calculation, the openings shall not be arranged in that part of the bulkhead which is common for the trunk and superstructure. An exemption may be made for small openings, for instance, for piping, cable, manholes with covers attached by means of bolts.

#### 4.2.5 Standard height of trunk.

The standard height of a trunk is the standard height of a superstructure given in Table 4.2.1, but not the height of a raised quarter deck.

#### 4.2.6 Effective length of trunk.

**4.2.6.1** The full length of an efficient standard height trunk multiplied by the ratio of its mean breadth to the ship's breadth shall be its effective length.

**4.2.6.2** Where the height of a trunk is less than the standard height its effective length shall be reduced in the ratio of the actual to the standard height.

Where the height of a trunk exceeds the standard height, no increase shall be made to the effective length of the trunk.

In those cases where the height of hatchway coamings on the trunk deck is less than that required under 3.2.4.1, a reduction from the actual height of trunk shall be made, equal to the difference between the actual and the required height of coaming.

Where the actual height of the trunk is less than the standard one, the required height of coaming shall be in any case assumed equal to 600 mm.

Reduction in the actual height of trunk shall not be required in cases where only small hatches with less than standard height are fitted in the trunk deck for which dispensation from the requirement of standard coaming height may be given by the Register.

Where the cargo hatchway is treated as a trunk, the height of the hatchway coaming reduced by 600 mm or the distance between the hatchway coaming top and the stringer if fitted outboard the hatchway coaming as referred to in 4.2.4.2, whichever is the greater, shall be taken as the design height of the trunk.

### 4.3 SHEER

#### 4.3.1 Measurement of sheer.

**4.3.1.1** The sheer shall be measured from the deck at side to a line of reference drawn parallel to the keel through the sheer line amidships. Where the lowest point of the sheer is not amidships, the ordinates of the sheer curve portion below the line of reference shall be taken into account as negative ordinates.

**4.3.1.2** In ships designed with a rake of keel, the sheer shall be measured in relation to a reference line drawn parallel to the design load waterline.

**4.3.1.3** In flush deck ships and in ships with detached superstructures the sheer shall be measured at the freeboard deck.

**4.3.1.4** In ships with topsides of unusual form in which there is a step or break in the topsides, the sheer shall be considered in relation to the moulded depth (see Fig. 1.2-3).

**4.3.1.5** In ships with a superstructure which extends over the whole length of the freeboard deck, the sheer shall be measured at the superstructure deck.

Where the height of a superstructure exceeds the standard, the least difference  $Z$  between the actual and standard heights shall be added to each end ordinate. Similarly, the intermediate ordinates at distances of  $1/6 L$  and  $1/3 L$  from each perpendicular shall be increased by  $0,444 Z$  and  $0,111 Z$ , respectively (Fig. 4.3.1.5).

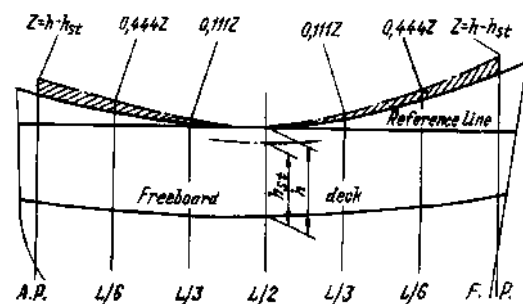

Fig. 4.3.1.5

**4.3.1.6** Where the deck of an enclosed superstructure has at least the same sheer as the exposed freeboard deck, the sheer of the enclosed portion of the freeboard deck is not taken into account. The extension of the sheer of the exposed portion of the freeboard deck parallel to the sheer of the superstructure deck is taken as the sheer line in way of such superstructure (Fig. 4.3.1.6).

Where the freeboard deck has no sheer, the sheer of the end superstructure and/or an excess in its

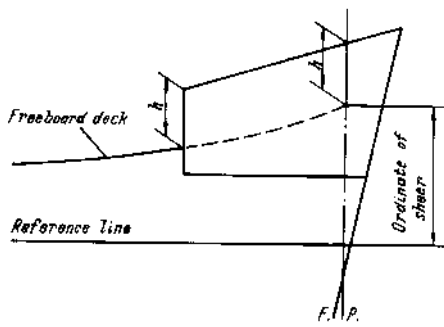

Fig. 4.3.1.6

height may be taken as the freeboard deck shear, provided that such superstructure extends over not less than  $0,15L$  from the perpendicular. Where the length of the end structure is smaller, the provisions of 4.3.1.7 apply.

**4.3.1.7** Where an enclosed poop or forecastle has greater shear than that of the freeboard deck, or is of more than standard height and also is not used 4.3.1.6 an addition to the shear of the freeboard deck shall be made as provided in 4.3.4. For the raised quarter deck at ship's ends such shear credit may be made only where the actual height of the raised quarter deck is greater than the standard height which is required for "other superstructures" as defined in Table 4.2.1.

**4.3.1.8** For an enclosed forecastle or poop superimposed on a complete superstructure extending along the whole length of the ship or for the second tier of the enclosed forecastle or poop the shear credit as provided in 4.3.4 may be allowed.  $Z$  shall be taken equal to the actual height of the forecastle or poop at the forward or after perpendicular.

Where the height of the complete superstructure on which a forecastle or poop is superimposed is greater than the standard height and its excess is not taken into account as provided in 4.3.1.5, the shear credit may be accounted for according to the Formula (4.3.4) both for the complete superstructure and for the superimposed forecastle or poor.  $Z$  for the forward and aft part of the complete superstructure shall be determined as shown in Fig. 4.3.1.8-1 and for the superimposed forecastle or poop the value  $Z'$  determined by the formula

$$Z' = Z_v + h - Z \tag{4.3.1.8-1}$$

shall be taken into account.

Where the height of the first tier of the enclosed forecastle or poop is greater than the standard height, then in calculating the shear credit referred to in 4.3.4,  $Z$  shall be determined for the first tier of the forecastle or poop as shown in Fig. 4.3.1.8-2, and for the second tier the value  $Z'$  shall be determined by the formula

$$Z' = Z_v + h - Z \tag{4.3.1.8-2}$$

shall be taken into account.  
When the length of the first tier or an enclosed poop or forecastle is greater than  $0,5L$ , the virtual standard parabolic curve shall commence at midships as indicated in Fig. 4.3.1.8-1.

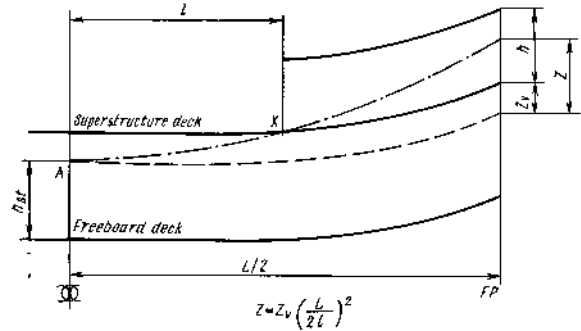

Fig. 4.3.1.8-1

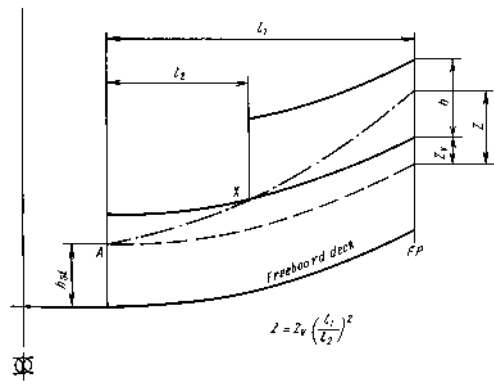

Fig. 4.3.1.8-2

In Figs 4.3.1.8.1 and 4.3.1.8.2 the following designations are accepted:

$Z_v$  = minimum difference between the actual and standard superstructure heights;

$Z$  = end ordinate of a virtual standard parabolic curve with the uppermost point  $A$  taken through the point  $X$ . If  $Z$  is greater than  $(Z_v + h)$ ,  $Z$  shall be equal to  $(Z_v + h)$ .

**4.3.2 Standard shear profile.**

The ordinates of the standard shear profile are given in Table 4.3.2 where the length of ship  $L$  is measured in metres.

**4.3.3 Measurement of variation from standard shear profile.**

**4.3.3.1** Where the shear profile differs from the standard, the four ordinates of each profile in the forward and after half shall be multiplied by the appropriate factors given in Table 4.3.2. The difference between the sums of the respective products and those of the standard divided by 8



Table 4.3.2

| Station      |                       | Ordinate, mm             | Factor |
|--------------|-----------------------|--------------------------|--------|
| After half   | After perpendicular   | $25(\frac{L}{3} + 10)$   | 1      |
|              | 1/6L from A.P.        | $11,1(\frac{L}{3} + 10)$ | 3      |
|              | 1/3L from A.P.        | $2,8(\frac{L}{3} + 10)$  | 3      |
|              | Amidships             | 0                        | 1      |
| Forward half | Amidships             | 0                        | 1      |
|              | 1/3L from F.P.        | $5,6(\frac{L}{3} + 10)$  | 3      |
|              | 1/6L from F.P.        | $22,2(\frac{L}{3} + 10)$ | 3      |
|              | Forward perpendicular | $50(\frac{L}{3} + 10)$   | 1      |

measures the deficiency or excess of sheer in the forward or after halves. The arithmetical mean of the excess or deficiency in the forward and after halves measures the excess or deficiency of sheer of the ship.

**4.3.3.2** Where the after half of the sheer profile is greater than the standard and the forward half is less than the standard, no credit shall be allowed for the excess sheer in the after half and only the deficiency in sheer in the forward half shall be measured.

**4.3.3.3** Where the forward half of the sheer profile exceeds the standard, and the after portion of the sheer profile is not less than 75 per cent of the standard, credit shall be given for the excess sheer in the forward half and the deficiency of sheer in the after half. Where the after part of the sheer profile is less than 50 per cent of the standard, no credit shall be given for the excess sheer forward and only the deficiency in sheer in the after half shall be measured. Where the after sheer is between 50 per cent and 75 per cent of the standard, proportionate correction shall be granted for the excess sheer in the forward half and full deficiency in the after half of the sheer.

**4.3.4 Correction for excess sheer or height of end superstructures.**

Where credit is given for the excess sheer or the height of a poop or forecastle, the correction for the excess sheer or the height of the end superstructures shall be determined by the formula

$$\Delta C = ZL'/3L \tag{4.3.4}$$

- where  $\Delta C$  = sheer credit, to be deducted from the deficiency or added to the excess of ship's sheer, mm;
- $Z$  = difference between actual height of superstructure at the aft or forward perpendicular and standard height of superstructure, mm;
- $L'$  = mean length of enclosed poop or forecastle up to a maximum length of 0,5L, m.

The above Formula (4.3.4) represents, in relation to the ship's length, the area of a square parabola tangent to the actual sheer curve at the point of intersection of the superstructure bulkhead with the freeboard deck and intersecting the end ordinate at a point below the superstructure deck at a distance equal to the effective height of superstructure. The superstructure deck shall not be less than the accounted height of the superstructure above this curve at any point (Figs 4.3.4-1, 4.3.4-2 and 4.3.4-3).

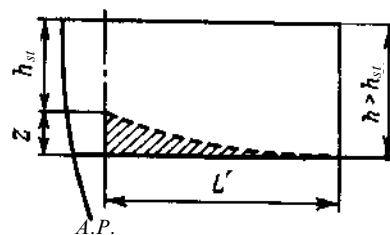

Fig. 4.3.4-1

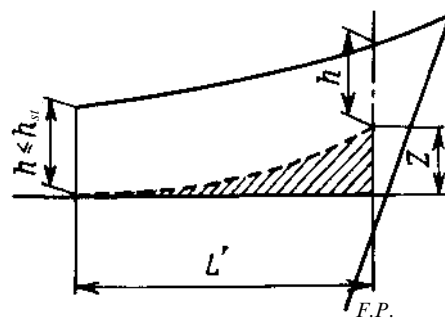

Fig. 4.3.4-2

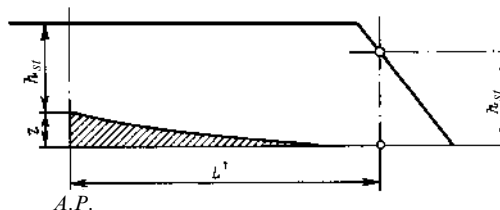

Fig. 4.3.4-3

Where the sheer credit is determined for the forward or after half of a ship separately, 0,5L shall be used to substitute L in the denominator in the above formula.

**4.4 CORRECTIONS TO TABULAR FREEBOARD**

**4.4.1 Determination of freeboard.**

The minimum summer freeboard for type A and B ships complying with the requirements of the present Rules shall be derived from Tables 4.1.2.3 and 4.1.3.2 as modified by the corrections given below. These corrections are made for the variation from the standard of the geometrical features of a ship, the standard being covered by the values of the tabular minimum summer freeboard.

**4.4.2 Correction to the freeboard for type B ships under 100 m in length.**

The tabular freeboard for type B ships of between 24 m and 100 m in length having enclosed superstructures with an effective length of less than 35 per cent of the length of the ship shall be increased by a value, mm,

$$7,5(100 - L)(0,35 - E/L) \tag{4.4.2}$$

where  $E$  = the effective length of superstructures, determined excluding the length of trunks, m.

**4.4.3 Correction for block coefficient.**

Where the block coefficient  $C_b$  exceeds 0,68, the tabular freeboard specified in Tables 4.1.2.3 and 4.1.3.2 as modified by the corrections in 4.1.3.4, 4.1.3.5, 4.1.3.6, 4.4.2, if applicable, shall be multiplied by the factor

$$(C_b + 0,68)/1,36. \tag{4.4.3}$$

**4.4.4 Correction for depth.**

**4.4.4.1** Where the depth of freeboard  $D$  exceeds  $L/15$  the freeboard shall be increased by a value, mm,

$$(D - L/15)R \tag{4.4.4.1}$$

where  $R = L/0,48$  at length of ship less than 120 m;  
 $R = 250$  at 120 m length of ship and above.

**4.4.4.2** Where  $D$  is less than  $L/15$ , no reduction shall be made, except in a ship with enclosed superstructures covering at least  $0,6L$  amidships, with a complete trunk, or combination of detached enclosed superstructures and trunks which extend all fore and aft. For such ships the freeboard shall be reduced at the rate prescribed in 4.4.4.1.

Where the height of a superstructure, raised quarter deck or that of the trunk is less than their respective standard height, the reduction shall be reduced in the ratio of the actual to the standard height. Where there are several superstructures,

trunks and quarter deck of different heights, their common actual height shall be the mean quantity determined on the basis of the actual and standard heights, and also lengths of the individual superstructures and trunks. The superstructures, quarter deck and trunks of greater than standard height are treated as having the standard height.

**4.4.5 Correction for position of deck line.**

Where the actual vertical distance measured from the top of the keel (in wooden and composite ships this distance is measured from the lower edge of the keel rabbet) to the upper edge of the deck line is greater or less than  $D$ , the difference between the depths shall be added to or deducted from the freeboard, respectively.

**4.4.6 Deduction for superstructures and trunks.**

**4.4.6.1** Where the effective length of superstructures and trunks is  $1,0L$ , the deduction from the freeboard shall be 350 mm at 24 m length of ship, 860 mm at 85 m length of ship, and 1070 mm at 122 m length of ships and above; deductions at intermediate lengths of ships shall be obtained by linear interpolation.

**4.4.6.2** Where the total effective length of superstructures and trunks is less than  $1,0L$  the deduction shall be a percentage obtained from Table 4.4.6.2.

Percentage deduction of intermediate lengths of superstructures and trunks shall be obtained by linear interpolation.

**4.4.6.3** For type B ships where the effective length of a forecastle is less than  $0,07L$ , no deduction is allowed.

**4.4.7 Correction for variations from standard sheer profile.**

**4.4.7.1** The correction for variations from the standard sheer profile shall be the deficiency or excess of sheer (4.3.3 and 4.3.4) multiplied by a value, mm,

$$0,75 - S/2L \tag{4.4.7.1}$$

where  $S$  = the total length of enclosed superstructures, m. The length of a trunk shall not be taken into account for calculating the total length  $S$ .

**4.4.7.2** Where the sheer is less than the standard, the correction for deficiency in sheer as calculated under 4.4.7.1 shall be added to the freeboard.

**4.4.7.3** In ships where an enclosed superstructure covers  $0,1L$  before and  $0,1L$  abaft amidships, the correction for excess of sheer as calculated under 4.4.7.1 shall be deducted from the freeboard.

Table 4.4.6.2

Percentage of deduction for types A and B ships

|  |   |      |      |      |      |      |      |      |      |      |      |
|--|---|------|------|------|------|------|------|------|------|------|------|
| Total effective length of superstructures and trunks     | 0 | 0,1L | 0,2L | 0,3L | 0,4L | 0,5L | 0,6L | 0,7L | 0,8L | 0,9L | 1,0L |
| Percentage of deduction for all types of superstructures | 0 | 7,0  | 14,0 | 21,0 | 31,0 | 41,0 | 52,0 | 63,0 | 75,3 | 87,7 | 100  |

In ships where no enclosed superstructure covers amidships, no deduction shall be made from the freeboard.

Where an enclosed superstructure covers less than  $0,1L$  before and  $0,1L$  abaft amidships, the deduction shall be obtained by linear interpolation. In this case, the deduction for excess sheer shall be reduced in the ratio of  $(a+b)/0,2L$  where  $a$  and  $b$  are the distances of the fore and aft bulkheads of enclosed bridge from amidships, m.

Where the value of  $a$  or  $b$  exceeds  $0,1L$ , it shall be taken as equal to  $0,1L$ .

In those cases where the height of the enclosed superstructure or raised quarter deck is less than the respective standard height, the reduction in the freeboard shall be in the ratio of the actual height to the standard one.

In any case, the maximum deduction for excess sheer shall be at the rate of 125 mm per 100 m of the length of the ship.

#### 4.4.8 Minimum bow height and reserve buoyancy.

**4.4.8.1** The bow height defined as the vertical distance at the forward perpendicular between the waterline corresponding to the assigned summer freeboard and the maximum designed trim at the bow, and the top of the exposed deck at side shall be not less than:

$$F_b = (6075(L/100) - 1875(L/100)^2 + 200(L/100)^3) \times (2,08 + 0,609C_b - 1,603C_{wf} - 0,0129L/d_1), \quad (4.4.8.1)$$

where  $F_b$  = the calculated minimum bow height, in mm;  
 $L$  = the ship's length, as defined in 1.2, in m;  
 $B$  = the moulded breadth, as defined in 1.2, in m;  
 $d_1$  = 85 per cent of the least moulded depth, in m;  
 $C_b$  = the block coefficient, as defined in 1.2;  
 $C_{wf}$  = the waterline area coefficient forward of  $L/2$ ;  
 $C_{wf} = 2A_{wf}(BL)$ ;  
 $A_{wf}$  = the waterline area forward of  $L/2$  at draught  $d_1$ , in  $m^2$ .

**4.4.8.2** Where the bow height required in 4.4.8.1 is obtained by sheer, the sheer shall extend for at least  $0,15L$  abaft the forward perpendicular. No point of the actual sheer shall be below the square parabola tangent at  $0,15L$  from the forward perpendicular tangent to a horizontal straight line drawn through the point of the actual sheer amidships and passing through a point at the forward perpendicular, corresponding to the minimum bow height.

**4.4.8.3** Where the bow height required in 4.4.8.1 is obtained by fitting a superstructure, such superstructure shall extend from the stem to a point at least  $0,07L$  abaft the forward perpendicular and shall be enclosed.

**4.4.8.4** When calculating the bow height, the sheer of the forecastle deck may be taken into account, even if the length of the forecastle is less than  $0,15L$ , but greater than  $0,07L$ , provided that the forecastle height is not less than one half of standard height of superstructure according to 4.2.1 between  $0,07L$  and the forward perpendicular.

Where the forecastle height is less than one half of standard height of superstructure, as defined in 4.2.1, the credited bow height may be determined as follows:

**.1** when the freeboard deck has sheer extending from abaft  $0,15L$ , by a parabolic curve having its origin at  $0,15L$  abaft the forward perpendicular at a height equal to the midship depth of the ship, extended through the point of intersection of forecastle bulkhead and deck, and up to a point at the forward perpendicular not higher than the level of the forecastle deck (Fig. 4.4.8.4-1). However, if the value of the height denoted  $h_t$  on Fig. 4.4.8.4-1 is smaller than the value of the height denoted  $h_b$ , then  $h_t$  may be replaced by  $h_b$  in the available bow height;

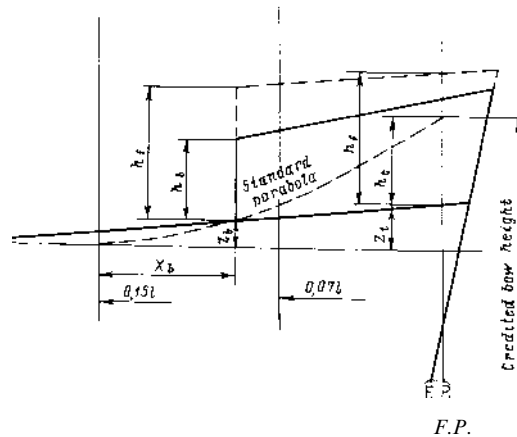

Fig. 4.4.8.4-1

**.2** when the freeboard deck has sheer extending for less than  $0,15L$  from a forward perpendicular or has no sheer, by a line from a point at the forecastle deck at side at  $0,07L$  passing parallel to the base line to the forward perpendicular (Fig. 4.4.8.4-2).

**4.4.8.5** On ships to which timber freeboards are assigned minimum bow height shall be determined not from the timber summer freeboard but as specified in 4.4.8.1.

**4.4.8.6** Freeboards for new ships which, to suit exceptional operational requirements, cannot meet the requirements of 4.4.8.1, 4.4.8.2, 4.4.8.3, and also for existing ships which do not comply with these requirements, are subject to special consideration by the Register in each case.

**4.4.8.7** All ships assigned a type "B" freeboard, other than oil tankers, chemical tankers and gas carriers, shall have additional reserve buoyancy in the fore end. Within the range of  $0,15L$  abaft of the forward perpendicular, the sum of the projected area between the summer load waterline and the deck at

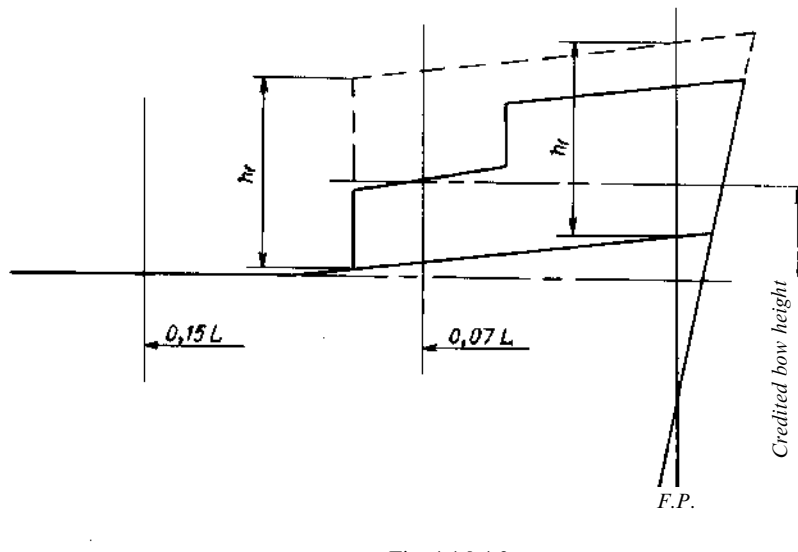

Fig. 4.4.8.4-2

side of an enclosed superstructure, in  $m^2$ , if fitted, shall not be less than:

$$(0,15F_{\min} + 4(L/3 + 10))L/1000 \quad (4.4.8.7)$$

where  $F_{\min}$  = the tabular freeboard taken from Table 4.1.3.2, (with regard to 4.1.3.4 or 4.1.3.5, as applicable) corrected for block coefficient (4.4.3) and depth (4.4.4).

**4.4.9 Correction for recess in the freeboard deck.**

**4.4.9.1** Where a recess is arranged in the freeboard deck, and this recess does not extend to the side of the ship, the freeboard calculated without regard to the recess shall be corrected for the consequent loss of buoyancy which is not included in the freeboard calculation. The correction would be equal to the value obtained by dividing the volume of the recess ( $lbd_r$ ) by the waterline area of the ship ( $A_w$ ) at 85 per cent of the moulded depth (Fig. 4.4.9.1).

**4.4.9.2** The correction shall be a straight addition to the freeboard obtained after all other corrections have been applied, except bow height correction.

**4.4.9.3** Where the freeboard, corrected for lost buoyancy as above, is greater than the minimum geometric freeboard determined on the basis of a moulded depth measured to the bottom of the recess the latter value may be used.

**4.4.9.4** Recesses in a second deck, designated as the freeboard deck, may be disregarded provided all openings in the weather deck are fitted with permanent closing appliances.

**4.4.9.5** Requirements of 4.4.9.1 to 4.4.9.4 are not intended to apply to dredgers, hopper barges or other similar types of ships with large open holds, where each case is subject to special consideration by the Register.

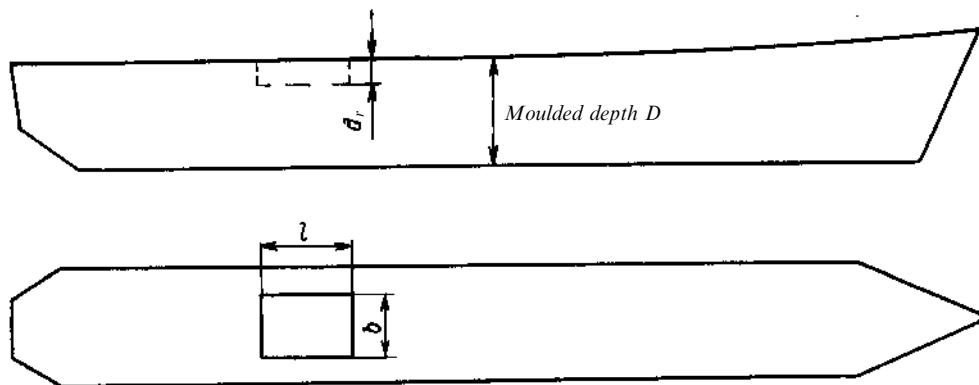

Fig. 4.4.9.1

**4.5 ASSIGNMENT OF MINIMUM FREEBOARD****4.5.1 Summer freeboard.**

**4.5.1.1** The minimum freeboard in summer shall be the freeboard derived from Tables 4.1.2.3 and 4.1.3.2 with regard to provisions of 4.1.2 to 4.1.4, if applicable, and corrections in 4.4.2 to 4.4.7, and, if applicable, 4.4.8 and 4.4.9.

**4.5.1.2** The freeboard in salt water, as calculated in accordance with 4.5.1.1, but without the correction for the position of deck line, as provided by 4.4.5, shall not be less than 50 mm. For ships having in position 1 cargo hatchways with covers which do not comply with the requirements of 3.2.4.7, 3.2.5 or 3.4.3, the freeboard shall be not less than 150 mm.

**4.5.1.3** For supply vessels the minimum height at the stern measured as a distance at aft perpendicular from the waterline, corresponding to assigned summer freeboard and maximum operating trim by the stern, to the upper edge of the open deck at ship's side shall be at least 0,005L.

**4.5.2 Tropical freeboard.**

**4.5.2.1** The minimum freeboard in the tropical zone shall be the freeboard obtained by a deduction from the summer freeboard of 1/48 of the summer draught measured from the top of the keel to the centre of the ring of the load line mark.

**4.5.2.2** The freeboard in salt water, as calculated in accordance with 4.5.2.1, but without the correction for the position of deck line, as provided by 4.4.5, shall not be less than 50 mm. For ships having in position 1 cargo hatchways with covers which do not comply with the requirements of 3.2.4.7, 3.2.5 or 3.4.3, the freeboard shall be not less than 150 mm.

**4.5.3 Winter freeboard.**

**4.5.3.1** The minimum freeboard in winter shall be the freeboard obtained by an addition to the summer freeboard of 1/48 of summer draught, measured from the top of the keel to the centre of the ring of the load line mark.

**4.5.3.2** When the minimum summer freeboard calculated in accordance with 4.5.1.1 is less than the freeboard allowed by paragraph 4.5.1.2, the correction for winter freeboard shall be added to the allowed minimum summer freeboard.

**4.5.4 Winter North Atlantic freeboard.**

The minimum freeboard for ships of not more than 100 m in length, which enter any part of the North Atlantic defined in item 8 of the Appendix to the present Rules during the winter seasonal period, shall be the winter freeboard plus 50 mm. For ships of over 100 m in length, the winter North Atlantic freeboard shall be the winter freeboard.

**4.5.5 Fresh water freeboard.**

**4.5.5.1** The minimum freeboard in fresh water of unit density shall be obtained by deducting from the minimum freeboard in salt water the value, in cm, determined by the formula

$$\Delta/40T \quad (4.4.5.1)$$

where  $\Delta$  = displacement of the ship in salt water at the summer load waterline, t;

$T$  = tons per 1 cm of immersion in salt water at the summer load waterline.

**4.5.5.2** When the minimum summer freeboard calculated in accordance with 4.5.1.1 is less than the freeboard allowed by 4.5.1.2, the allowance for fresh water freeboard shall be deducted from the allowed minimum summer freeboard.

**4.5.5.3** Where the displacement at the summer load waterline cannot be certified, the deduction shall be 1/48 of summer draught, measured from the top of the keel to the centre of the ring of the load line mark.

## 5 SPECIAL REQUIREMENTS FOR SHIPS ENGAGED IN INTERNATIONAL VOYAGES WHICH ARE ASSIGNED TIMBER FREEBOARDS

### 5.1 CONDITIONS OF ASSIGNMENT OF TIMBER FREEBOARDS

#### 5.1.1 Timber load line.

A timber deck cargo may be regarded as giving a ship a certain additional buoyancy and a greater degree of protection against the sea. For that reason, ships carrying a timber deck cargo may be granted a reduction of freeboard calculated according to the provisions of this Chapter and marked on the ship's side in accordance with the provisions of 2.2.2. However, in order that such special freeboard may be granted, and used, the ship shall comply with certain conditions relating to her construction which are set out in 5.1.2, and the stowage of the timber deck cargo shall comply with the conditions laid down in 5.1.3.

#### 5.1.2 Construction of ship.

**5.1.2.1** Ships shall have a forecastle of at least standard height and a length of at least  $0,07L$ . In addition, if the ship is less than 100 m in length, a poop of at least standard height, or a raised quarter deck with either a deckhouse or a strong steel hood of at least the same total height shall be fitted aft.

**5.1.2.2** Double bottom tanks where fitted within the area extending  $0,25L$  forward or abaft the midship shall have adequate watertight longitudinal subdivision approved by the Register.

**5.1.2.3** The ship shall be fitted either with permanent bulwarks at least 1 m in height, specially stiffened on the upper edge and supported by strong bulwark stays and provided with necessary freeing ports, or with efficient rails of the same height and of specially strong construction. The bulwark stays shall be securely attached to the deck at beams or at other specially stiffened places.

#### 5.1.3 Stowage of cargo.

**5.1.3.1** Openings in the weather deck over which cargo is stowed shall be securely closed and battened down. The ventilators and air pipes shall be efficiently protected.

**5.1.3.2** Timber deck cargo shall extend over at least the entire available length which is the total length of the wells between superstructures.

Where there is no limiting superstructure at the after end, the timber shall extend at least to the after end of the aftermost hatchway.

The timber deck cargo shall extend athwartships as close as possible to the ship sides, due allowance being given for obstructions, such as guard rails, bulwark stays, uprights, etc. provided

any gap thus created at the side of the ship shall not exceed  $0,04B$ .

The timber shall be stowed as solidly as possible to at least the standard height of the superstructure, other than a raised quarter deck.

**5.1.3.3** The height of the timber deck cargo allowed on a given ship shall be mentioned in the Information of ship's stability. On a ship within a seasonal winter zone in winter, the height of the deck cargo above the weather deck shall not exceed  $1/3$  of the extreme breadth of the ship.

Provision shall be made for a safe margin of stability at all stages of the voyage, regard being given to additions in weight of the ship, such as those due to absorption of water by cargo and icing and to losses of weight, such as those due to consumption of fuel and stores.

**5.1.3.4** The timber deck cargo shall be compactly stowed, lashed and secured. It shall not interfere in any way with the navigation and necessary work of the ship.

**5.1.3.5** Uprights, when required by the nature of the timber carried, shall be of adequate strength considering the breadth of the ship.

The strength of the uprights shall not exceed the strength of the bulwark. The spacing of the uprights shall be suitable for the length and character of timber carried, but shall not exceed 3 m. Strong angles, metal sockets or equally efficient means shall be provided for securing the uprights.

**5.1.3.6** Timber deck cargo shall be efficiently secured throughout its length by independent overall lashings.

The spacing of the lashings shall be determined by the maximum height of the cargo above the weather deck in the vicinity of the lashing:

**.1** for a height of 4 m and below the spacing shall be not more than 3 m;

**.2** for a height of 6 m and above the spacing shall be not more than 1,5 m;

**.3** at intermediate heights the average spacing shall be obtained by linear interpolation.

Where the height of timber deck cargo exceeds 6 m, the strength of the lashings shall be specially considered by the Register. Eye plates for these lashings shall be efficiently attached to the sheer strake or to the deck stringer plate and spaced not more than 3 m apart. The distance from an end bulkhead of a superstructure to the first eye plate shall be not more than 2 m.

Eye plates and lashings shall be provided 0,6 m and 1,5 m from the ends of timber deck cargoes where there is no bulkhead.

**5.1.3.7** Lashings shall be a short link chain or a flexible wire rope and a breaking load of a chain or an actual breaking strength of a wire rope shall be not less than 133 kN.

Lashings shall be fitted with sliphooks and turnbuckles which shall be accessible at all times. Wire rope lashings shall have a short length of long link chain to permit the length of lashings to be regulated.

When timber is in length less than 3,6 m, the spacing of the lashings shall be reduced or other suitable provisions made to suit the length of timber.

**5.1.3.8** Shackles, stretching devices and all other ancillary components incorporated into a chain or wire rope lashing and its securings shall have a minimum ultimate load 133 kN. Each component shall be proof loaded to 55 kN. No part shall be damaged or permanently deformed after proof loading.

**5.1.3.9** The cargo shall be properly levelled up to permit passage over it. Guard rails or life lines spaced not more than 330 mm apart vertically shall be provided on each side of the timber deck cargo to a height of at least 1 m above the cargo.

Where the cargo is uneven, a safe walking surface of not less than 600 mm in width shall be fitted over the cargo and effectively secured beneath or adjacent to the lifeline.

**5.1.3.10** Steering arrangements shall be effectively protected from damage by cargo and, as far as practicable, shall be readily accessible. Efficient provision shall be made for steering in the event of a breakdown in the main steering gear.

**5.2 CALCULATION OF MINIMUM TIMBER FREEBOARDS**

**5.2.1 Summer timber freeboard.**

The minimum summer timber freeboard shall be calculated in accordance with 4.1.3.1 and 4.1.3.2 and also as modified by the corrections in 4.4.2 to 4.4.7, and, if applicable, in 4.1.4 and 4.4.9. In this case, the percentages given in Table 5.2.1 shall be substituted for those given in Table 4.4.6.2-2.

**5.2.2 Winter timber freeboard.**

The minimum winter timber freeboard shall be obtained by adding to the minimum summer timber freeboard 1/36 of the summer timber draught.

**5.2.3 Winter North Atlantic timber freeboard.**

The minimum winter North Atlantic timber freeboard shall be the same as the winter North Atlantic freeboard prescribed in 4.5.4 (Fig. 5.2.3).

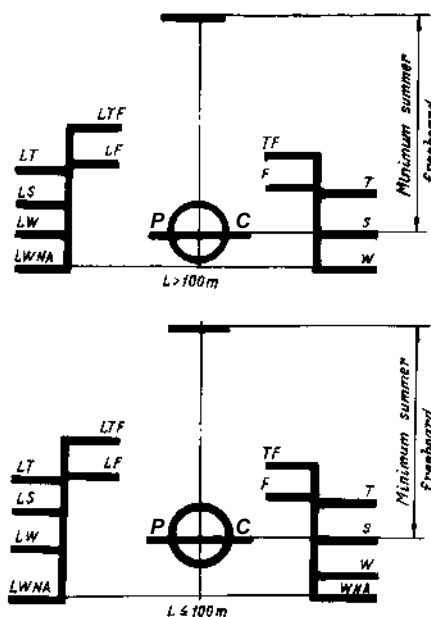

Fig. 5.2.3

**5.2.4 Tropical timber freeboard.**

The minimum tropical timber freeboard shall be obtained by deducting from the summer timber freeboard 1/48 of the summer timber draught.

**5.2.5 Fresh water timber freeboard.**

The minimum fresh water timber freeboard shall be calculated in accordance with 4.5.5.1 or with 4.5.5.2 based on the summer timber draught.

**5.2.6 Timber freeboard on type B ships with reduced freeboard.**

The timber freeboard on type B ships with reduced freeboard in compliance with 4.1.3.4 and 4.1.3.5 shall be assigned in conformity with the provisions of the present Chapter on the basis of the ordinary type B ship.

In this case, timber winter freeboard and/or timber winter North Atlantic freeboard shall not be assigned greater than winter freeboard calculated for type B ships having reduced freeboards.

Table 5.2.1

|  |    |      |      |      |      |      |      |      |      |      |      |
|--|----|------|------|------|------|------|------|------|------|------|------|
| Total effective length of superstructures                | 0  | 0,1L | 0,2L | 0,3L | 0,4L | 0,5L | 0,6L | 0,7L | 0,8L | 0,9L | 1,0L |
| Percentage of deduction for all types of superstructures | 20 | 31   | 42   | 53   | 64   | 70   | 76   | 82   | 88   | 94   | 100  |

Note. Percentages at intermediate lengths of superstructures shall be obtained by linear interpolation.

## 6 LOAD LINES OF SHIPS OF 24 M IN LENGTH AND MORE NOT ENGAGED IN INTERNATIONAL VOYAGES<sup>1</sup> AND FISHING VESSELS

### 6.1 APPLICATION

**6.1.1** The ships specified in 1.1.1.1.2 may be assigned the minimum freeboard depending on the area of navigation permitted for them and their designation:

**.1** ships of unrestricted service, passenger and sailing ships, irrespective of the area of navigation, as well as ships of restricted area of navigation **R1**, **R2**, **R2-RSN** and **R3-RSN** operating in the Northern Seas (the Kara Sea, the Laptev Sea, the East-Siberian Sea and the Sea of Chukotsk), in the Bering Sea and the Sea of Okhotsk, in compliance with 6.4.1 and 6.5.2;

**.2** ships of restricted area of navigation **R1**, **R2**, **R2-RSN** and **R3-RSN**, except for those indicated in 6.1.1.1 above, in conformity with 6.4.2 and 6.5.2;

**.3** ships of restricted area of navigation **R3**, in compliance with 6.4.3 and 6.5.2.

For assigning the freeboard all the requirements specified in 6.3 shall be met in each ship. The possibility of any departure from these requirements is subject to special consideration by the Register in each case.

### 6.2 MARKING

#### 6.2.1 Deck line.

Deck line shall be marked in accordance with 2.1.1.

#### 6.2.2 Load line mark.

The load line mark for each ship shall consist of a ring 300 mm in outside diameter and 25 mm wide which is divided by the vertical line 25 mm in width, passing through its centre, which is intersected by a horizontal line 450 mm in length and 25 mm in breadth, the upper edge of which passes through the centre of the ring.

The centre of the ring is placed amidships and at a distance equal to the assigned summer freeboard measured vertically below the upper edge of the deck line (Fig. 6.2.2).

#### 6.2.3 Lines to be used with the load line mark.

**6.2.3.1** The lines which indicate the load line in ships of unrestricted service, operating in different zones, areas and during different seasonal periods, shall be applied in compliance with the requirements in 2.2.

The load lines for ships of unrestricted service are shown in Fig. 6.2.3.1.

<sup>1</sup>Ships engaged on international voyages solely in the Caspian Sea are assigned freeboard in compliance with the provisions of the present Section as ships of restricted area of navigation.

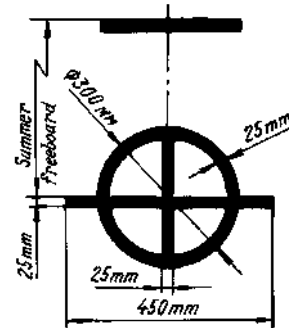

Fig. 6.2.2

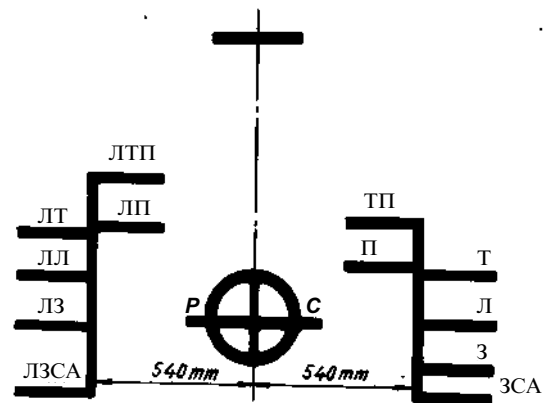

Fig. 6.2.3.1

**6.2.3.2** On ships of restricted areas of navigation **R1**, **R2**, **R2-RSN**, **R3-RSN** and **R3**, operating in different area and during different seasonal periods the following load lines out of those listed in 2.2.1 and 2.2.2 shall be applied:

- .1** the summer load line (J);
- .2** the winter load line (3);
- .3** the fresh water load line in summer (П);
- .4** the summer timber load line (JЛ);
- .5** the winter timber load line (JЗ);
- .6** the fresh water timber load line in summer (JТП).

In sailing and passenger ships, as well as in ships assigned a greater than minimum freeboard, load lines shall be marked in conformity with the provisions 2.2.3 to 2.2.6. In this case, load lines only out of those listed above shall be marked, and for passenger ships, also additional subdivision load lines.

Load lines of ships of restricted area of navigation **R1**, **R2**, **R2-RSN**, **R3-RSN** and **R3** with minimum freeboard are shown in Fig. 6.2.3.2.



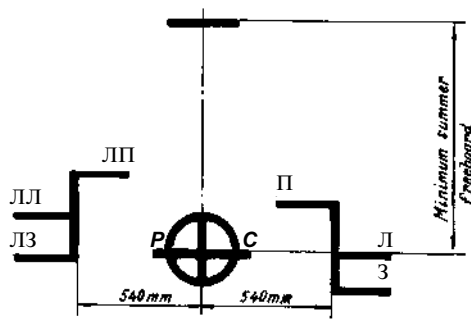

Fig. 6.2.3.2

### 6.2.4 Doubled load lines.

If the ship is assigned doubled freeboard in compliance with 1.1.1.11, additional load line mark is not indicated on the ship's sides. The additional load lines are marked at a distance of 1200 mm forward (for timber lines, abaft) from the centre of the ring of the main load line mark (Figs 6.2.4-1 and 6.2.4-2).

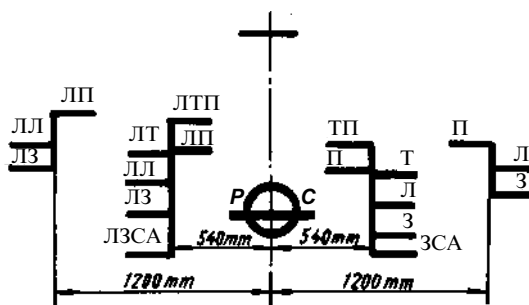

Fig. 6.2.4-1

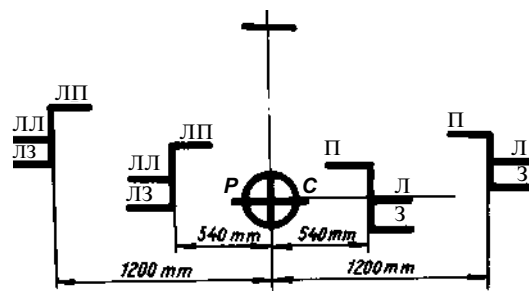

Fig. 6.2.4-2

### 6.2.5 Load line designation and marking.

The load lines of ships not engaged in international voyages and fishing vessels shall be designated and marked in compliance with 2.3.

## 6.3 CONDITIONS OF ASSIGNMENT OF FREEBOARDS

**6.3.1** The requirements of Section 3 of the present Rules shall be met in every ship.

The following deviations are allowed.

**6.3.1.1** The height of door sills, hatchway, ventilator coamings and air pipes may be reduced in ships of restricted area of navigation **R2**, **R2-RSN** and **R3-RSN** except for ships specified in 6.1.1.1.

The extent of this reduction depends on the navigation conditions and design features of the ship and is subject to special consideration by the Register in each case. In no case shall reduced heights be less than those given below for ships of restricted area of navigation **R3**.

**6.3.1.2** In ships of restricted area of navigation **R3**, except for passenger ships, the height of door sills, hatchway and ventilator coamings and air pipes may be reduced as follows:

**1** the height of door sills, as given in 3.2.2.2, down to 230 mm;

**2** the height of hatchway coamings, as given in 3.2.4.1, down to 450 mm in position 1 and to 380 mm in position 2;

**3** the height of door sills, as given in 3.2.6.1 and 3.2.7.3, from 600 mm down to 450 mm and from 380 mm down to 230 mm;

**4** the height of ventilator coamings, as given in 3.2.8.1, down to 760 mm in position 1 and to 600 mm in position 2;

**5** the height of air pipes, as given in 3.2.9, down to 600 mm on the freeboard decks and also on the decks of sunken forecandle and poop and to 380 mm on the decks of other superstructures.

**6.3.1.3** In ships of restricted area of navigation **R2**, **R2-RSN**, **R3-RSN** and **R3** no side scuttle shall be fitted in a position so that its sill is below a line drawn parallel to the freeboard deck at side and having its lowest point 0,025B above the summer load waterline.

**6.3.1.4** The assumed load on the hatchway covers given in 3.2.4 and 3.2.5 may be reduced for the ships of restricted areas of navigation **R2**, **R2-RSN**, **R3-RSN** and **R3** in conformity with 7.10.4.1, Part III "Equipment, Arrangements and Outfit" of Rules for the Classification and Construction of Sea-Going Ships.

#### 6.4 ASSIGNMENT OF MINIMUM FREEBOARDS

##### 6.4.1 Ships of unrestricted service and assimilated to them.

The minimum freeboard of ships of unrestricted service and assimilated to them in accordance with 6.1.1.1 shall be calculated in full compliance with the provisions of Section 4 of the present Rules.

##### 6.4.2 Ships of restricted areas of navigation R1, R2, R2-RSN and R3-RSN.

6.4.2.1 The minimum freeboard of ships of restricted areas of navigation **R1**, **R2**, **R2-RSN** and **R3-RSN**, except for those mentioned in 6.1.1.1 shall be calculated in compliance with the requirements of Section 4 of the present Rules, except for 4.5.2 and 4.5.4 and also in conformity with the requirements of in 6.4.2.2 and 6.4.2.3.

6.4.2.2 The freeboard of type A ships shall be assigned on the basis of Table 6.4.2.2. Where the requirements of Section 4 of these Rules shall be applied, all references to Table 4.1.2.3 shall be replaced by references to Table 6.4.2.2.

6.4.2.3 The freeboard of type B ships shall be assigned on the basis of Table 6.4.2.3. Where the requirements of Section 4 of these Rules shall be applied, all references to Table 4.1.3.2 shall be replaced by references to Table 6.4.2.3.

##### 6.4.3 Ships of restricted area of navigation R3.

6.4.3.1 The freeboards of ships of restricted area of navigation **R3** shall be calculated in compliance with the provisions of Section 4 of the present Rules (except for 4.1.2.2, 4.4.2, 4.4.8, 4.5.2 and 4.5.4), as well as in conformity with the provisions given below in 6.4.3.2 and 6.4.3.3.

Table 6.4.2.2

Tabular freeboards for type A ships of restricted areas of navigation R1, R2, R2-RSN and R3-RSN

| Length of ship, m | Freeboard, mm | Length of ship, m | Freeboard, mm | Length of ship, m | Freeboard, mm | Length of ship, m | Freeboard, mm |
|-------------------|---------------|-------------------|---------------|-------------------|---------------|-------------------|---------------|
| 24                | 190           | 69                | 630           | 114               | 1279          | 159               | 2031          |
| 27                | 210           | 72                | 670           | 117               | 1329          | 162               | 2075          |
| 30                | 235           | 75                | 710           | 120               | 1379          | 165               | 2118          |
| 33                | 260           | 78                | 750           | 123               | 1431          | 168               | 2160          |
| 36                | 285           | 81                | 790           | 126               | 1483          | 171               | 2201          |
| 39                | 310           | 84                | 830           | 129               | 1535          | 174               | 2240          |
| 42                | 335           | 87                | 870           | 132               | 1587          | 177               | 2287          |
| 45                | 365           | 90                | 910           | 135               | 1639          | 189               | 2313          |
| 48                | 395           | 93                | 955           | 138               | 1690          | 183               | 2348          |
| 51                | 425           | 96                | 1000          | 141               | 1740          | 186               | 2383          |
| 54                | 455           | 99                | 1045          | 144               | 1790          | 189               | 2417          |
| 57                | 490           | 102               | 1090          | 147               | 1839          | 192               | 2450          |
| 60                | 525           | 105               | 1135          | 150               | 1888          | 195               | 2482          |
| 63                | 560           | 108               | 1180          | 153               | 1936          | 198               | 2512          |
| 66                | 595           | 111               | 1229          | 156               | 1984          | 201               | 2542          |

Note. Freeboards at intermediate lengths of ships shall be obtained by linear interpolation.  
Ships above 201 m in length shall be dealt with by the Register.

Table 6.4.2.3

Tabular freeboards for type B ships of restricted areas of navigation R1, R2, R2-RSN and R3-RSN

| Length of ship, m | Freeboard, mm | Length of ship, m | Freeboard, mm | Length of ship, m | Freeboard, mm | Length of ship, m | Freeboard, mm |
|-------------------|---------------|-------------------|---------------|-------------------|---------------|-------------------|---------------|
| 24                | 200           | 69                | 650           | 114               | 1405          | 159               | 2340          |
| 27                | 225           | 72                | 690           | 117               | 1470          | 162               | 2400          |
| 30                | 250           | 75                | 730           | 120               | 1530          | 165               | 2460          |
| 33                | 275           | 78                | 770           | 123               | 1590          | 168               | 2520          |
| 36                | 300           | 81                | 815           | 126               | 1655          | 171               | 2575          |
| 39                | 325           | 84                | 860           | 129               | 1720          | 174               | 2635          |
| 42                | 350           | 87                | 905           | 132               | 1780          | 177               | 2695          |
| 45                | 380           | 90                | 955           | 135               | 1840          | 189               | 2755          |
| 48                | 410           | 93                | 1005          | 138               | 1905          | 183               | 2810          |
| 51                | 440           | 96                | 1055          | 141               | 1970          | 186               | 2866          |
| 54                | 470           | 99                | 1110          | 144               | 2030          | 189               | 2920          |
| 57                | 505           | 102               | 1165          | 147               | 2090          | 192               | 2974          |
| 60                | 540           | 105               | 1220          | 150               | 2155          | 195               | 3025          |
| 63                | 575           | 108               | 1280          | 153               | 2215          | 198               | 3075          |
| 66                | 610           | 111               | 1340          | 156               | 2280          | 201               | 3120          |

Note. Freeboards at intermediate lengths of ships shall be obtained by linear interpolation.  
Ships above 201 m in length shall be dealt with by the Register.

The bow height of ships of coastal navigation shall not be less than the value of the tabular freeboard increased by the ordinate of standard sheer at the forward perpendicular.

**6.4.3.2** The freeboard of type A ships shall be assigned on the basis of Table 6.4.3.2. Where the requirements of Section 4 of these Rules shall be applied, all references to Table 4.1.2.3 shall be replaced by references to Table 6.4.3.2.

**6.4.3.3** Type B ships, except for the cases provided in 4.1.3.3 to 4.1.3.6, shall be assigned the freeboards not less than those determined on the basis of Table 6.4.3.3.

**6.5 SPECIAL REQUIREMENTS FOR SHIPS ASSIGNED TIMBER FREEBOARDS**

**6.5.1 Conditions of assignment of timber freeboards.**

For assigning the timber freeboard the requirements of 5.1 shall be met in ships.

**6.5.2 Calculation of the minimum timber freeboard.**

**6.5.2.1** Minimum summer timber freeboard shall be calculated as follows:

**.1** for ships of unrestricted service and assimilated to them in conformity with 6.1.1, in compliance with 4.1.3.1 and 4.1.3.2;

**.2** for ships of restricted areas of navigation **R1**, **R2**, **R2-RSN** and **R3-RSN**, except for those specified in 6.1.1, in compliance with 4.1.3.1 and 6.4.2.3;

**.3** for ships of restricted area of navigation **R3**, in compliance with 4.1.3.1 and 6.4.3.3.

The corrections given in 4.4.2 to 4.4.7, and, if applicable, in 4.1.4 shall be taken into account. When determining the deduction for superstructures and trunks in accordance with 4.4.6, Table 4.4.6.2-2 shall be substituted by Table 5.2.1.

**6.5.2.2** The minimum winter timber freeboard shall be obtained by adding to the minimum summer timber freeboard 1/36 of summer timber draught measured from the top of the flat keel.

**6.5.2.3** The minimum fresh water timber freeboard shall be calculated in accordance with 4.5.5 based on the summer timber load waterline.

Table 6.4.3.2

**Tabular freeboards for type A ships of restricted area of navigation R3**

| Length of ship, m | Freeboard, mm | Length of ship, m | Freeboard, mm | Length of ship, m | Freeboard, mm | Length of ship, m | Freeboard, mm |
|-------------------|---------------|-------------------|---------------|-------------------|---------------|-------------------|---------------|
| 24                | 190           | 57                | 460           | 90                | 820           | 123               | 1317          |
| 27                | 210           | 60                | 490           | 93                | 860           | 126               | 1369          |
| 30                | 230           | 63                | 520           | 96                | 900           | 129               | 1421          |
| 33                | 250           | 66                | 550           | 99                | 945           | 132               | 1473          |
| 36                | 275           | 69                | 580           | 102               | 990           | 135               | 1525          |
| 39                | 300           | 72                | 610           | 105               | 1035          | 138               | 1586          |
| 42                | 325           | 75                | 645           | 108               | 1080          | 141               | 1626          |
| 45                | 350           | 78                | 680           | 111               | 1125          | 144               | 1676          |
| 48                | 375           | 81                | 710           | 114               | 1170          | 147               | 1725          |
| 51                | 400           | 84                | 745           | 117               | 1215          | 150               | 1774          |
| 54                | 430           | 87                | 780           | 120               | 1265          |                   |               |

Note. Freeboards at intermediate lengths of ships shall be obtained by linear interpolation. Ships above 150 m in length shall be dealt with by the Register.

Table 6.4.3.3

**Tabular freeboards for type B ships of restricted area of navigation R3**

| Length of ship, m | Freeboard, mm | Length of ship, m | Freeboard, mm | Length of ship, m | Freeboard, mm | Length of ship, m | Freeboard, mm |
|-------------------|---------------|-------------------|---------------|-------------------|---------------|-------------------|---------------|
| 24                | 200           | 57                | 475           | 90                | 880           | 123               | 1450          |
| 27                | 220           | 60                | 505           | 93                | 925           | 126               | 1515          |
| 30                | 240           | 63                | 535           | 96                | 975           | 129               | 1580          |
| 33                | 260           | 66                | 565           | 99                | 1025          | 132               | 1640          |
| 36                | 280           | 69                | 600           | 102               | 1075          | 135               | 1700          |
| 39                | 305           | 72                | 635           | 105               | 1125          | 138               | 1765          |
| 42                | 330           | 75                | 670           | 108               | 1175          | 141               | 1830          |
| 45                | 355           | 78                | 710           | 111               | 1230          | 144               | 1890          |
| 48                | 385           | 81                | 750           | 114               | 1285          | 147               | 1950          |
| 51                | 415           | 84                | 790           | 117               | 1340          | 150               | 2015          |
| 54                | 445           | 87                | 835           | 120               | 1390          |                   |               |

Note. Freeboards at intermediate length of ships shall be obtained by linear interpolation. Ships above 150 m in length shall be dealt with by the Register.

## 7 LOAD LINES OF MOBILE OFFSHORE DRILLING UNITS

### 7.1 GENERAL

#### 7.1.1 Application.

**7.1.1.1** These requirements shall apply to drilling ship's and MODU types referred to in 1.2 Part I "Classification" of Rules for the Classification and Construction and Equipment of Mobile Offshore Drilling Units and Fixed Offshore Platforms<sup>1</sup> and intended for drilling operations for the exploration and/or exploitation of resources beneath the sea bed.

**7.1.1.2** MODU in the design of which new approaches to MODU structure, supporting forces, etc. are used and to which these Rules cannot be applied are subject to special consideration by the Register.

**7.1.1.3** Existing MODUs which do not meet the present Rules to a full extent shall at least comply with the provisions of the Rules applied to these MODUs prior to coming into force of the present requirements.

#### 7.1.2 Definitions and explanations.

Unless otherwise provided, definitions and explanations relating to the terminology of this Section are given in 1.2.

#### 7.1.3 Scope of technical supervision and Certificates.

Scope of technical supervision and Certificates shall be in compliance with the requirements of 1.4.

#### 7.1.4 General technical requirements.

Minimum freeboard values for MODUs are specified in these requirements. Nothing in these requirements shall prevent the assignment of a greater freeboard than the minimum value determined according to 7.3.1 to 7.3.3.

#### 7.1.5 Application of load lines.

Load lines shall apply to:  
drilling ships;  
self-elevating units in the field move (transit) condition;  
semi-submersible and submersible MODUs in operating condition.

### 7.2 MARKING

#### 7.2.1 Deck line and load line mark.

**7.2.1.1** The dimensions of the deck line shall be determined in compliance with 2.1.1.

**7.2.1.2** The deck line shall be marked on drilling ships and self-elevating units in compliance with 2.1.1 and on semi-submersible and submersible units it shall be marked on the columns above the load line mark with indication in the International Load Line Certificate of its distance from the lowest hull edge (working platform) of the unit.

**7.2.1.3** The dimensions and configuration of the load line mark shall be in compliance with 2.1.2. The number and location of the load line marks are subject to special consideration by the Register.

#### 7.2.2 Lines to be used with the load line mark.

Lines referred to in 2.2 shall be used for drilling ships and self-elevating units. No lines are marked on semi-submersible and submersible units.

#### 7.2.3 Mark of assigning authority. Details of marking. Marking of draughts.

**7.2.3.1** The mark of the authority by whom the load lines are assigned and details of marking shall be in compliance with 2.3.

**7.2.3.2** It is recommended that the columns of semi-submersible and submersible units above and below the draught of the unit in the operating condition be painted in different colours.

It is recommended that waterline in severe storm conditions (if such is provided in the design) and that in field move (transit) condition be indicated by a painted strip 100 mm wide. The lower edge of the strip shall be considered as a draught line. The upper and lower edges of the strip shall be punched.

Load lines, waterlines and draught marks shall be readily visible to attending personnel when performing mooring operations, during submersion and raising of the unit.

Figures of draught marks on pontoons show a draught in decimetres, those on the columns — in metres.

### 7.3 MINIMUM FREEBOARDS AND CONDITIONS OF THEIR ASSIGNMENT

#### 7.3.1 Drilling ships.

**7.3.1.1** Minimum freeboards of drilling ships and conditions of their assignment shall meet the requirements of Sections 2 and 3.

**7.3.1.2** Where wells, such as moonpools, trunks for lowering (raising) diving bell and other wells are arranged within the hull, the volume of the wells shall be deducted from the displacement of the unit when determining the block coefficient used for freeboard calculations. An addition shall be made to the

<sup>1</sup>Hereinafter referred to as "MODU/FOP Rules".

freeboard, equal to the volume of the well divided by the waterline area (having no regard to the opening area). The volume of wells or openings shall be deducted where it exceeds 0,5 per cent of displacement.

Otherwise, deduction from the displacement and correction to the freeboard shall not be made.

### 7.3.2 Self-elevating units.

**7.3.2.1** Freeboard of self-elevating units and conditions of its assignment shall be in compliance with Sections 2 and 3.

**7.3.2.2** Wells or openings arranged within the unit's hull shall be taken into account in accordance with 7.3.1.2.

**7.3.2.3** The structures of legs, possessing buoyancy shall not be taken into account in determining the displacement for the purposes of freeboard calculation.

**7.3.2.4** When self-elevating units are assigned the freeboard and they are expected to be manned when under tow, the requirements of 4.4.8 as regards the minimum bow height shall be met.

Where this requirement is difficult to achieve, adequate substantiation confirming safe conditions of the move (transit) of the unit on the predetermined route with indication of allowable wind and sea state for the field move (transit) period shall be submitted in each case.

### 7.3.3 Semi-submersible units.

**7.3.3.1** Freeboard of semi-submersible units is based on the value of clearance assumed in compliance with 3.2.1.1, Part II "Hull" of the MODU/FOP Rules, intact and damage stability and strength calculations.

**7.3.3.2** Sill and coaming heights and closing appliances of doors, hatches, ventilator openings, air pipe heights, etc. on the working deck, as well as sanitary discharge pipes penetrating the shell and originating from the spaces which were taken into account in the arms of form stability calculations shall meet the requirements of Part III "Equipment, Arrangements and Outfit of MODU/FOP" and Part VIII "Systems and Piping" of the MODU/FOP Rules.

## 8 LOAD LINES OF SHIPS OF LESS THAN 24 M IN LENGTH

### 8.1 APPLICATION

**8.1.1** The ships specified in 1.1.1.1.4 may be assigned the minimum freeboard for operation in allowed restricted areas of navigation **R1**, **R2** or **R3** in compliance with 8.4.

For assigning the freeboard all the requirements specified in 8.3 shall be met in each ship. Possible departures from these requirements are subject to special consideration by the Register in each case.

### 8.2 MARKING

#### 8.2.1 Deck line.

The deck line is a horizontal line 200 mm in length and 20 mm in breadth. It shall be marked on each side of the ship in compliance with 2.1.1.

#### 8.2.2 Load line mark.

The load line mark shall consist of a ring 200 mm in outside diameter and 20 mm wide divided by a vertical line 20 mm in breadth passing through its centre and intersected by a horizontal line 300 mm in length and 20 mm in breadth, the upper edge of which passes through the centre of the ring.

The centre of the ring shall be placed amidships and at a distance equal to the assigned freeboard

measured vertically below the upper edge of the deck line (similar to Fig. 6.2.2).

#### 8.2.3 Lines to be used with the load line mark.

Ships have no special load lines indicating the position of load waterlines when navigating in various zones, areas and in seasonal periods as well as in fresh water and may be loaded up to the upper edge of the horizontal line passing through the centre of the ring of the load line mark.

On passenger and other ships with greater than minimum freeboard the load line mark shall be positioned as provided in 2.2.4 to 2.2.6. On passenger ships additional subdivision loadlines shall be marked together with the load line mark.

#### 8.2.4 Load line mark designation and marking.

The load line mark shall be designated and marked in compliance with 2.3. In so doing, the dimensions of the letters specified in 2.3.2 shall be taken equal to 75 mm in height and 50 mm in width.

### 8.3 CONDITIONS OF ASSIGNMENT OF FREEBOARDS

**8.3.1** On each ship the requirements of Section 3 of the present Rules shall be fulfilled as well as the following requirements.

**8.3.1.1** On ships of restricted areas of navigations **R2** and **R3** the height of door sills, hatchway and ventilator coamings may be reduced as follows:

.1 the height of door sills, as given in 3.2.2.2, down to 230 mm;

.2 the height of hatchway coamings, as given in 3.2.4.1, down to 380 mm for ships of restricted area of navigation **R2** and down to 300 mm for ships of restricted area of navigation **R3**, whatever the positions of the hatchway on a ship may be;

.3 the height of hatchway coamings, as given in 3.2.4.1, down to 300 mm for fishing vessels, in position 2;

.4 the height of door sills, as given in 3.2.6.1, down to 300 mm;

.5 the height of door sills, as given in 3.2.7.3 — down to 230 mm;

.6 the height of ventilator coamings, as given in 3.2.8.1, down to 300 mm.

**8.3.1.2** The assumed loads for hatchways may be reduced by 15 per cent for ships of restricted area of navigation **R2** and by 30 per cent for ships of restricted area of navigation **R3** as against the loads specified in 3.2.4.5 for ships of 24 m and less in length.

**8.3.1.3** In ships of restricted areas of navigation **R2** and **R3** no side scuttle shall be fitted in a position that its lower edge is below the line drawn parallel to the freeboard deck at side and having its lowest point at a distance from the waterline passing through the centre of the ring of the load line mark equal to: 300 mm for ships of restricted area of navigation **R2**, and 150 mm for ships of restricted area of navigation **R3**.

**8.3.1.4** The minimum area of freeing ports in the bulwark, as given in 3.2.13.1, shall be at least 10 per cent of the area of each continuous portion of the bulwark, the provisions of 3.2.13.2 to 3.2.13.5 being not applied.

**8.3.1.5** In ships of restricted area of navigation **R3** the discharges, as defined in 3.2.11, may be fitted only with one locally-controlled non-return shut-off valve.

## 8.4 ASSIGNMENT OF MINIMUM FREEBOARDS

### 8.4.1 Freeboard table.

A ship shall be assigned the freeboard not less than that based on Table 8.4.1.

Table 8.4.1

Tabular freeboards

| Length of ship, m   | 10 and less | 15  | 20  | 24  |
|---|-------------|-----|-----|-----|
| Freeboard, mm   | 306         | 340 | 375 | 400 |
| Note. Freeboards at intermediate lengths shall be obtained by linear interpolation. |             |     |     |     |

### 8.4.2 Superstructures.

#### 8.4.2.1 Standard height of superstructure.

The standard height of a superstructure is assumed to be equal to 1 m.

#### 8.4.2.2 Effective length of superstructure.

**8.4.2.2.1** Except as provided in 8.4.2.2.3, the effective length of an enclosed superstructure of standard height shall be its length.

**8.4.2.2.2** Where the height of an enclosed superstructure is less than the standard height, the effective length shall be its length reduced in the ratio of the actual height to the standard height. Where the height of the superstructure exceeds the standard, no increase shall be made to the effective length of the superstructure.

**8.4.2.2.3** Where the superstructure is a forecastle, the effective length of such superstructure may be increased in 1,5 times.

#### 8.4.3 Corrections of tabular freeboard.

##### 8.4.3.1 Determination of freeboard.

The freeboard of ships complying with the requirements of the present Rules shall be derived from Table 8.4.1 as modified by the corrections given below.

##### 8.4.3.2 Correction for depth.

Where the depth for freeboard  $D$  exceeds  $L/15$ , the freeboard shall be increased, in mm, by

$$(D - L/15)L/0,48. \quad (8.4.3.2)$$

Where  $D$  is less than  $L/15$ , no reduction shall be made.

##### 8.4.3.3 Deduction for superstructures.

If a ship has enclosed superstructures, her freeboard determined in compliance with 8.4.3.1 and 8.4.3.2 may be reduced by

5 per cent with total effective length of superstructures equal to  $0,2L$ ;

20 per cent with total effective length of superstructures equal to  $0,5L$  and more.

Percentages of deduction for intermediate length of superstructures shall be obtained by linear interpolation.

##### 8.4.3.4 Correction for height of coamings.

The freeboard of the ship shall be increased where the height of even one coaming of deck opening leading to the spaces which are treated as independent when subdivision of the ship is checked is less than that required by the present Rules.

The increase of freeboard height shall be:

$$\Delta f = h_r - h_a \quad (8.4.3.4)$$

where  $h_r - h_a$  = the greatest difference between the required and the actual heights of coamings.

**8.4.3.5** Correction for angle of deck immersion<sup>1</sup>.

Irrespective of the requirements of 8.4.1, 8.4.3.2, 8.4.3.3, 8.4.3.4 the freeboard of fishing vessels shall be such as the angle of deck edge immersion is at least 12° for ships of up to 15 m in length and at least 6° for ships of 24 m in length.

The minimum permissible angle of deck edge immersion for intermediate lengths of ships shall be obtained by linear interpolation.

**8.4.3.6** Minimum bow height of freeboard.

**8.4.3.6.1** The minimum bow height of freeboard as defined in 4.4.8.1 shall be not less than that obtained by the formula, in mm,

$$56L(1 - L/500) \quad (8.4.3.6.1)$$

**8.4.3.6.2** The extension of sheer or superstructure due to which the bow height of freeboard required by 8.4.3.6.1 is obtained shall be determined in compliance with 4.4.8.2 and 4.4.8.3.

**8.4.3.6.3** Irrespective of 8.4.3.6.1 minimum bow height of the "protected freeboard" measured similarly to the bow height of freeboard according to 4.4.8.1 but to the top of the bulwark rail or visor shall be not less than 0,1L.

**8.4.3.6.4** Where the required bow height of the "protected freeboard" is obtained by provision of a bulwark or visor, it shall extend from the stem to the point situated at a distance equal to at least 0,1L aft of the forward perpendicular.

**8.4.3.7** Minimum stern height of freeboard.

**8.4.3.7.1** Minimum stern height of freeboard obtained as specified of freeboard in 4.4.8.1, but at the after perpendicular at the maximum designed trim by the stern shall be equal to not less than half the bow height of freeboard as given in 8.4.3.6.1.

**8.4.3.7.2** Where the stern height of freeboard required by 8.4.3.7.1 is obtained by sheer or superstructure, the extension thereof shall be not less than half that required by 4.4.8.2 and 4.4.8.3, respectively.

**8.4.3.8** For ships of harbour and roadstead service the bow and stern heights of freeboard may be reduced, the bow height being not less than 0,5 m, and stern height not less than minimum midship height.

**8.4.3.9** For ships having such sheer or superstructures that the requirements of 8.4.3.6 and 8.4.3.7 are fulfilled to excess, the Register may permit the reduction of freeboard as against that required in the present Chapter provided openings in the deck and superstructures are properly arranged and closed.

## APPENDIX

### ZONES, AREAS AND SEASONAL PERIODS

#### 1 GENERAL

**1.1** The zones and areas given in the present Appendix are, in general, based on the following criteria:

**.1 s u m m e r** — not more than 10 per cent winds force 8 Beaufort (34 knots) or more;

**.2 t r o p i c a l** — not more than 1 per cent winds of force 8 Beaufort (34 knots) or more. Not more than one tropical storm in 10 years in an area of 5° longitude and 5° latitude in any one separate calendar month.

In certain special areas, for practical reasons, some degree of relaxation has been found acceptable.

A chart is attached to this Appendix to illustrate the zones and areas defined below.

#### 2 NORTHERN WINTER SEASONAL ZONES AND AREAS

##### 2.1 North Atlantic winter seasonal zones I and II

**2.1.1** The North Atlantic winter seasonal zone I lies within the meridian of longitude 50°W from the coast of Greenland to latitude 45°N, thence the parallel of latitude 45°N to longitude 15°W, thence the meridian of longitude 15°W to latitude 60°N, thence the parallel of latitude 60°N to the Greenwich Meridian, thence this meridian northwards.

##### *Seasonal periods*

Winter: 16 October to 15 April;  
Summer: 16 April to 15 October.

<sup>1</sup>Angle of deck edge immersion is an angle measured in the midship section between the waterline and a straight line connecting the point of intersection of the waterline with the centre line and the point at the ship's side at the level of the moulded depth.

**2.1.2** The North Atlantic winter seasonal zone II lies within the meridian of longitude 68°30' W from the coast of the United States to latitude 40°N, thence the rhumb line to the point latitude 36°N, longitude 73°W, thence the parallel of latitude 36°N to longitude 25°W and thence the rhumb line to Cape Torinana.

Excluded from this zone are the North Atlantic winter seasonal zone I, North Atlantic winter seasonal area and the Baltic Sea bounded by the parallel of latitude of the Skaw in the Skagerrak. The Shetland Islands shall be considered as being on the boundary line of the North Atlantic winter seasonal zones I and II.

*Seasonal periods*

Winter: 1 November to 31 March;  
Summer: 1 April to 31 October.

**2.2 North Atlantic winter seasonal area**

**2.2.1** The boundary of the North Atlantic winter sea-sonal area is the meridian of longitude 68°30' W from the coast of the United States to latitude 40°N, thence the rhumb line to the southernmost intersection of the meridian of longitude 61°W with the coast of Canada and thence the east coasts of Canada and the United States.

*Seasonal periods*

**.1** for ships over 100 m in length:  
Winter: 16 December to 15 February;  
Summer: 16 February to 15 December;  
**.2** for ships of 100 m and under in length:  
Winter: 1 November to 31 March;  
Summer: 1 April to 31 October.

**2.3 North Pacific winter seasonal zone**

**2.3.1** The southern boundary of the North Pacific winter seasonal zone is the parallel of latitude 50°N from the east coast of the Russian Federation to the west coast of Sakhalin, thence the west coast of Sakhalin to the southern extremity of Cape Kril'on, thence the rhumb line to Wakkanai, Hokkaido (Japan), thence the east and south coast of Hokkaido to longitude 145°E, thence the meridian of longitude 145°E to latitude 35°N, thence the parallel of latitude 35°N to longitude 150°W and thence the rhumb line to the southern extremity of Dall Island (Alaska).

*Seasonal periods*

Winter: 16 October to 15 April;  
Summer: 16 April to 15 October.

**3 SOUTHERN WINTER SEASONAL ZONE**

**3.1** The northern boundary of the Southern Winter Seasonal Zone is the rhumb line from the east coast of the American continent at Cape Tres Puntas to the point latitude 34°S, longitude 50°W, thence the parallel of latitude 34°S to longitude 17°E, thence the rhumb line to the point latitude 35°10' S, longitude 20°E, thence the rhumb line to the point latitude 34°S, longitude 28°E, thence along the rhumb line to the point latitude 35°30' S, longitude 118°E, and thence the rhumb line to Cape Grim on the northwest coast of Tasmania; thence along the north and east coasts of Tasmania to the southernmost point of Bruny Island, thence the rhumb line to Black Rock Point on Stewart Island, thence the rhumb line to the point latitude 47°S, longitude 170°E, thence along the rhumb line to the point latitude 33°S, longitude 170°W, and thence the parallel of latitude 33°S to the point latitude 33°S, longitude 79°W, thence the rhumb line to the point latitude 41°S, longitude 75°W, thence the rhumb line to Punta Corona lighthouse on Chiloe Island, latitude 41°47S, longitude 73°53W, thence along the north, east and south coasts of Chiloe Island to the point latitude 43°20S, longitude 74°20W, and thence the meridian of longitude 74°20W to the parallel of latitude 45°45S, including the inner zone of Chiloe channels from the meridian 74°20W to the east.

*Seasonal periods*

Winter: 16 April to 15 October;  
Summer: 16 October to 15 April.

**4 TROPICAL ZONE**

**4.1 Northern boundary of the tropical zone**

**4.1.1** The northern boundary of the tropical zone is the parallel of latitude 13°N from the east coast of the American continent to longitude 60°W, thence the rhumb line to the point latitude 10°N, longitude 58°W, thence the parallel of latitude 10°N to longitude 20°W, thence the meridian of longitude 20°W to latitude 30°N and thence the parallel of latitude 30°N to the west coast of Africa; from the east coast of



Africa the parallel of latitude  $8^{\circ}\text{N}$  to longitude  $70^{\circ}\text{E}$ , thence the meridian of longitude  $70^{\circ}\text{E}$  to latitude  $13^{\circ}\text{N}$ , thence the parallel of latitude  $13^{\circ}\text{N}$  to the west coast of India; thence the south coast of India to latitude  $10^{\circ}30'\text{N}$  on the east coast of India, thence the rhumb line to the point latitude  $9^{\circ}\text{N}$ , longitude  $82^{\circ}\text{E}$ , thence the meridian of longitude  $82^{\circ}\text{E}$  to latitude  $8^{\circ}\text{N}$ , thence the parallel of latitude  $8^{\circ}\text{N}$  to the west coast of Malaysia, thence the coast of South-East Asia, to the east coast of Viet-Nam at latitude  $10^{\circ}\text{N}$ , thence the parallel of latitude  $10^{\circ}\text{N}$  to longitude  $145^{\circ}\text{E}$ , thence the meridian of longitude  $145^{\circ}\text{E}$  to latitude  $13^{\circ}\text{N}$  and thence the parallel of latitude  $13^{\circ}\text{N}$  to the west coast of the American continent.

Saigon shall be considered as being on the boundary line of the tropical zone and the seasonal tropical area.

#### 4.2 Southern boundary of the tropical zone

**4.2.1** The southern boundary of the tropical zone is the rhumb line from the Port of Santos, Brazil, to the point where the meridian of longitude  $40^{\circ}\text{W}$  intersects the Tropic of Capricorn; thence the Tropic of Capricorn to the west coast of Africa; from the east coast of Africa the parallel of latitude  $20^{\circ}\text{S}$  to the west coast of Madagascar, thence the west and north coasts of Madagascar to longitude  $50^{\circ}\text{E}$ , thence the meridian of longitude  $50^{\circ}\text{E}$  to latitude  $10^{\circ}\text{E}$ , thence the parallel of latitude  $10^{\circ}\text{S}$  to longitude  $98^{\circ}\text{E}$ , thence the rhumb line to Port Darwin, Australia, thence the coasts of Australia and Wessel Island eastwards to Cape Wessel, thence the parallel of latitude  $11^{\circ}\text{S}$  to the west side of Cape York; from the east side of Cape York the parallel of latitude  $11^{\circ}\text{S}$  to longitude  $150^{\circ}\text{W}$ , thence the rhumb line to the point latitude  $26^{\circ}\text{S}$ , longitude  $75^{\circ}\text{W}$ , and thence the rhumb line to the point latitude  $32^{\circ}47\text{S}$ , longitude  $72^{\circ}\text{W}$ , and thence to the parallel of latitude  $32^{\circ}47\text{S}$  to the west coast of South America.

Valparaiso and Santos shall be considered as being on the boundary line of the tropical and summer zones.

#### 4.3 Areas to be included in the tropical zone

**4.3.1** The following areas shall be treated as included in the tropical zone:

**.1** the Suez Canal, the Red Sea and the Gulf of Aden, from Port Said to the meridian of longitude  $45^{\circ}\text{E}$ . Aden and Berbera shall be considered as being on the boundary line of the tropical zone and the seasonal tropical area;

**.2** the Persian Gulf to the meridian of longitude  $59^{\circ}\text{E}$ ;

**.3** the area bounded by the parallel of latitude  $22^{\circ}\text{S}$  from the east coast of Australia to the Great Barrier Reef, thence the Great Barrier Reef to latitude  $11^{\circ}\text{S}$ . The northern boundary of the area is the southern boundary of the tropical zone.

## 5 SEASONAL TROPICAL AREAS

### 5.1 In the north atlantic

#### 5.1.1 An area bounded:

in the north by the rhumb line from Cape Catoche (Yucatan), to Cape San Antonio (Cuba), the north coast of Cuba to latitude  $20^{\circ}\text{N}$  and thence the parallel of latitude  $20^{\circ}\text{N}$  to longitude  $20^{\circ}\text{W}$ ;

in the west by the coast of the American continent;

in the south and east by the northern boundary of the tropical zone.

#### *Seasonal periods*

Tropical: 1 November to 15 July;

Summer: 16 July to 31 October.

### 5.2 In the arabian sea

#### 5.2.1 An area bounded:

in the west by the coast of Africa, the meridian of longitude  $45^{\circ}\text{E}$  in the Gulf of Aden, the coast of South Arabia and the meridian of longitude  $59^{\circ}\text{E}$  in the Gulf of Oman;

in the north and east by the coasts of Pakistan and India;

in the south by the northern boundary of the tropical zone.

#### *Seasonal periods*

Tropical: 1 September to 31 May;

Summer: 1 June to 31 August.

### 5.3 In the bay of bengal

**5.3.1** The Bay of Bengal north of the northern boundary of the tropical zone.

#### *Seasonal periods*

Tropical: 1 December to 30 April;

Summer: 1 May to 30 November.

**5.4 In the south indian ocean**

**5.4.1** The following areas:

**.1** an area bounded:

in the north and west by the southern boundary of the tropical zone and the east coast of Madagascar;

in the south by the parallel of latitude 20°S;

in the east by the rhumb line from the point latitude 20°S, longitude 50°E to the point latitude 15°S, longitude 51°30' E, and thence by the meridian of longitude 51°30' E to latitude 10°S.

*Seasonal periods*

**Tropical:** 1 April to 30 November;  
**Summer:** 1 December to 31 March;

**.2** an area bounded:

in the north by the southern boundary of the tropical zone;

in the east by the coast of Australia;

in the south by the parallel of latitude 15°S from longitude 51°30' E, to longitude 114°E and thence the meridian of longitude 114°E to the coast of Australia;

in the west by the meridian of longitude 51°30' E.

*Seasonal periods*

**Tropical:** 1 May to 30 November;  
**Summer:** 1 December to 30 April.

**5.5 In the south china sea**

**5.5.1** An area bounded:

in the west and north by the coasts of Viet-Nam and China from latitude 10°N to Hong Kong;

in the east by the rhumb line from Hong Kong to the Port of Sual (Luzon Island) and the west coast of the Islands of Luzon, Samar and Leyte to latitude 10°N;

in the south by parallel of latitude 10°N.

Hong Kong and Sual shall be considered as being on the boundary of the Seasonal Tropical Area and Summer Zone.

*Seasonal periods*

**Tropical:** 21 January to 30 April;  
**Summer:** 1 May to 20 January.

**5.6 In the North Pacific**

**5.6.1** The following areas:

**.1** an area bounded:

in the north by the parallel of latitude 25°N;

in the west by the meridian of longitude 160°E;

in the south by the parallel of latitude 13°N;

in the east by the meridian of longitude 130°W.

*Seasonal periods*

**Tropical:** 1 April to 31 October;  
**Summer:** 1 November to 31 March;

**.2** an area bounded:

in the north and east by the west coast of the American continent;

in the west by the meridian of longitude 123°W from the coast of the American continent to latitude 33°N and by the rhumb line from the point latitude 33°N, longitude 123°W, to the point latitude 13°N, longitude 105°W;

in the south by the parallel of latitude 13°N.

*Seasonal periods*

**Tropical:** 1 March to 30 June and 1 November to 30 November;

**Summer:** 1 July to 31 October and 1 December to 28/29 February.

**5.7 In the South Pacific**

**5.7.1** The following areas:

**.1** the Gulf of Carpentaria south of latitude 11°S.

*Seasonal periods*

**Tropical:** 1 April to 30 November;  
**Summer:** 1 December to 31 March;

**.2** an area bounded:

in the north and east by the southern boundary of the tropical zone;

in the south by the parallel of latitude 24°S from the east coast of Australia to longitude 154°E, thence by the meridian of longitude 154°E to the Tropic of Capricorn and thence by the Tropic of Capricorn to longitude 150°W, thence by the meridian of longitude 150°W to latitude 20°S and thence by the parallel of latitude 20°S to the point where it intersects the southern boundary of the tropical zone;

in the west by the boundaries of the area within the Great Barrier Reef included in the tropical zone and by the east coast of Australia.

*Seasonal periods*

Tropical: 1 April to 30 November;  
Summer: 1 December to 31 March.

**6 SUMMER ZONES**

**6.1** The remaining areas constitute the summer zones.

However, for ships of 100 m and under in length, the area bounded:

in the north and west by the east coast of the United States;

in the east by the meridian of longitude 68°30' W from the coast of the United States to latitude 40°N and thence by the rhumb line to the point latitude 36°N, longitude 73°W;

in the south by the parallel of latitude 36°N is a winter seasonal area.

*Seasonal periods*

Winter: 1 November to 31 March;  
Summer: 1 April to 31 October.

**7 ENCLOSED SEAS**

**7.1 Baltic Sea**

**7.1.1** This sea bounded by the parallel of latitude of The Skaw in the Skagerrak is included in the summer zone.

However, for ships of 100 m and under in length, it is a winter seasonal area.

*Seasonal periods*

Winter: 1 November to 31 March;  
Summer: 1 April to 31 October.

**7.2 Black Sea and Sea of Azov**

**7.2.1** The Black Sea and the Sea of Azov are included in the summer zone.

However, for ships of 100 m and under in length, the area north of latitude 44°N is a winter seasonal area.

*Seasonal periods*

Winter: 1 December to 28/29 February;  
Summer: 1 March to 30 November.

**7.3 Mediterranean**

**7.3.1** This sea is included in the summer zone.

However, for ships of 100 m and under in length, the area bounded:

in the north and west by the coasts of France and Spain and the meridian of longitude 3°E from the coast of Spain to latitude 40°N;

in the south by the parallel of latitude 40°N from longitude 3°E to the west coast of Sardinia;

in the east by the west and north coasts of Sardinia from latitude 40°N to longitude 9°E, thence by the meridian of longitude 9°E to the south coast of Corsica, thence by the west and north coasts of Corsica to longitude 9°E and thence by the rhumb line to Cape Sicié is a winter seasonal area.

*Seasonal periods*

Winter: 16 December to 15 March;  
Summer: 16 March to 15 December.

**7.4 Sea of Japan**

**7.4.1** This sea south of latitude 50°N is included in the summer zone.

However, for ships of 100 m and under in length, the area between the parallel of latitude 50°N and the rhumb line from the east coast of Korea at latitude 38°N to the west coast of Hokkaido (Japan), at latitude 43°12' N is a winter seasonal area.

*Seasonal periods*

Winter: 1 December to 28/29 February;  
Summer: 1 March to 30 November.

**7.5 Caspian Sea**

**7.5.1** The Caspian Sea is included in the summer zone.

However, for ships of 100 m and under in length, it is a winter seasonal area.

*Seasonal periods*

Winter: 1 December to 15 March;  
Summer: 16 March to 30 November.

**8 WINTER NORTH ATLANTIC LOAD LINE**

**8.1** The part of the North Atlantic referred to in 4.5.4 comprises:

**.1** that part of the North Atlantic winter seasonal zone II which lies between the meridians of 15°W and 50°W;

**.2** the whole of the North Atlantic winter seasonal zone I, the Shetland Islands to be considered as being on the boundary.



Российский морской регистр судоходства  
**Правила по оборудованию морских судов.**  
**Правила по грузоподъемным устройствам морских судов.**  
**Правила о грузовой марке морских судов**  
**Издание 2008 г.**

Russian Maritime Register of Shipping  
**Rules for the Equipment of Sea-Going Ships.**  
**Rules for the Cargo Handling Gear of Sea-Going Ships.**  
**Load Line Rules for Sea-Going Ships**  
**Edition 2008**

The edition is prepared  
by Russian Maritime Register of Shipping  
8, Dvortsovaya Naberezhnaya,  
191186, St. Petersburg,  
Russian Federation  
Tel.: +7(812) 312-89-59  
Fax: +7(812) 312-89-86