

ПРАВИЛА КЛАССИФИКАЦИИ И ПОСТРОЙКИ МОРСКИХ СУДОВ

ЧАСТЬ XVIII

ДОПОЛНИТЕЛЬНЫЕ ТРЕБОВАНИЯ К КОНТЕЙНЕРОВОЗАМ
И СУДАМ, ПЕРЕВОЗЯЩИМ ГРУЗЫ ПРЕИМУЩЕСТВЕННО
В КОНТЕЙНЕРАХ

RULES FOR THE CLASSIFICATION AND CONSTRUCTION OF SEA-GOING SHIPS

PART XVIII

ADDITIONAL REQUIREMENTS FOR STRUCTURES
OF CONTAINER SHIPS AND SHIPS, DEDICATED PRIMARILY
TO CARRY THEIR LOAD IN CONTAINERS

ND No. 2-020101-152-R-E



**St. Petersburg
2022**

ПРАВИЛА КЛАССИФИКАЦИИ И ПОСТРОЙКИ МОРСКИХ СУДОВ

Правила классификации и постройки морских судов Российского морского регистра судоходства утверждены в соответствии с действующим положением и вступают в силу 1 января 2022 года (за исключением части XX «Дополнительные требования к коммерческим яхтам», вступающей в силу 15 марта 2022 года).

Настоящее издание Правил составлено на основе издания 2021 года с учетом изменений и дополнений, подготовленных непосредственно к моменту переиздания.

В Правилах учтены процедурные требования, унифицированные требования, унифицированные интерпретации и рекомендации Международной ассоциации классификационных обществ (МАКО) и соответствующие резолюции Международной морской организации (ИМО).

Правила состоят из следующих частей:

- часть I «Классификация»;
 - часть II «Корпус»;
 - часть III «Устройства, оборудование и снабжение»;
 - часть IV «Остойчивость»;
 - часть V «Деление на отсеки»;
 - часть VI «Противопожарная защита»;
 - часть VII «Механические установки»;
 - часть VIII «Системы и трубопроводы»;
 - часть IX «Механизмы»;
 - часть X «Котлы, теплообменные аппараты и сосуды под давлением»;
 - часть XI «Электрическое оборудование»;
 - часть XII «Холодильные установки»;
 - часть XIII «Материалы»;
 - часть XIV «Сварка»;
 - часть XV «Автоматизация»;
 - часть XVI «Конструкция и прочность судов из полимерных композиционных материалов»;
 - часть XVII «Дополнительные знаки символа класса и словесные характеристики, определяющие конструктивные или эксплуатационные особенности судна»;
 - часть XVIII «Дополнительные требования к контейнеровозам и судам, перевозящим грузы преимущественно в контейнерах» (Part XVIII "Additional Requirements for Structures of Container Ships and Ships, Dedicated Primarily to Carry their Load in Containers"). Текст части XVIII соответствует УТ МАКО S11A «Требования к продольной прочности контейнеровозов» (июнь 2015) и S34 «Функциональные требования к вариантам нагрузки при проверке прочности контейнеровозов методом конечных элементов» (май 2015);
 - часть XIX «Дополнительные требования к грузовым судам валовой вместимостью менее 500»;
 - часть XX «Дополнительные требования к коммерческим яхтам»;
- Приложение к Правилам и Руководствам Российского морского регистра судоходства «Процедурные требования, унифицированные требования, унифицированные интерпретации и рекомендации Международной ассоциации классификационных обществ».

RULES FOR THE CLASSIFICATION AND CONSTRUCTION OF SEA-GOING SHIPS

Rules for the Classification and Construction of Sea-Going Ships of Russian Maritime Register of Shipping have been approved in accordance with the established approval procedure and come into force on 1 January 2022 (except for Part XX "Additional Requirements for Commercial Yachts" which comes into force on 15 March 2022).

The present edition of the Rules is based on the 2021 edition taking into account the amendments and additions developed immediately before publication.

The procedural requirements, unified requirements, unified interpretations and recommendations of the International Association of Classification Societies (IACS) and the relevant resolutions of the International Maritime Organization (IMO) have been taken into consideration.

The Rules are published in the following parts:

- Part I "Classification";
 - Part II "Hull";
 - Part III "Equipment, Arrangements and Outfit";
 - Part IV "Stability";
 - Part V "Subdivision";
 - Part VI "Fire Protection";
 - Part VII "Machinery Installations";
 - Part VIII "Systems and Piping";
 - Part IX "Machinery";
 - Part X "Boilers, Heat Exchangers and Pressure Vessels";
 - Part XI "Electrical Equipment";
 - Part XII "Refrigerating Plants";
 - Part XIII "Materials";
 - Part XIV "Welding";
 - Part XV "Automation";
 - Part XVI "Structure and Strength of Fiber-Reinforced Plastic Ships";
 - Part XVII "Distinguishing Marks and Descriptive Notations in the Class Notation Specifying Structural and Operational Particulars of Ships";
 - Part XVIII "Additional Requirements for Structures of Container Ships and Ships, Dedicated Primarily to Carry their Load in Containers". The text of the Part is identical to IACS UR S11A "Longitudinal Strength Standard for Container Ships" (June 2015) and S34 "Functional Requirements on Load Cases for Strength Assessment of Container Ships by Finite Element Analysis" (May 2015);
 - Part XIX "Additional Requirements for Cargo Ships of Less Than 500 Gross Tonnage";
 - Part XX "Additional Requirements for Commercial Yachts";
- Supplement to Rules and Guidelines of Russian Maritime Register of Shipping "IACS Procedural Requirements, Unified Requirements, Unified Interpretations and Recommendations".

S11A Longitudinal Strength Standard for Container Ships

(June 2015)

S11A.1 General

S11A.1.1 Application

S11A.1.1.1 Application

This UR applies to the following types of steel ships with a length L of 90 m and greater and operated in unrestricted service:

1. Container ships
2. Ships dedicated primarily to carry their load in containers.

S11A.1.1.2 Load limitations

The wave induced load requirements apply to monohull displacement ships in unrestricted service and are limited to ships meeting the following criteria:

- | | |
|--|--|
| (i) Length | $90 \text{ m} \leq L \leq 500 \text{ m}$ |
| (ii) Proportion | $5 \leq L/B \leq 9; \quad 2 \leq B/T \leq 6$ |
| (iii) Block coefficient at scantling draught | $0.55 \leq C_B \leq 0.9$ |

For ships that do not meet all of the aforementioned criteria, special considerations such as direct calculations of wave induced loads may be required by the Classification Society.

S11A.1.1.3 Longitudinal extent of strength assessment

The stiffness, yield strength, buckling strength and hull girder ultimate strength assessment are to be carried out in way of 0.2L to 0.75L with due consideration given to locations where there are significant changes in hull cross section, e.g. changing of framing system and the fore and aft end of the forward bridge block in case of two-island designs.

In addition, strength assessments are to be carried out outside this area. As a minimum assessments are to be carried out at forward end of the foremost cargo hold and the aft end of the aft most cargo hold. Evaluation criteria used for these assessments are determined by the Classification Society.

Note:

1. This UR is to be uniformly implemented by IACS Societies for ships contracted for construction on or after 1 July 2016.
2. The “contracted for construction” date means the date on which the contract to build the vessel is signed between the prospective owner and the shipbuilder. For further details regarding the date of “contract for construction”, refer to IACS Procedural Requirement (PR) No. 29.

S11A

(cont)

S11A.1.2 Symbols and definitions

S11A.1.2.1 Symbols

L	Rule length, in m, as defined in UR S2
B	Moulded breadth, in m
C	Wave parameter, see 2.3.2
T	Scantling draught in m
C_B	Block coefficient at scantling draught
C_w	Waterplane coefficient at scantling draught, to be taken as: $C_w = \frac{A_w}{(LB)}$
A_w	Waterplane area at scantling draught, in m ²
R_{eH}	Specified minimum yield stress of the material, in N/mm ²
k	Material factor as defined in UR S4 for higher tensile steels, $k=1.0$ for mild steel having a minimum yield strength equal to 235 N/mm ²
E	Young's modulus in N/mm ² to be taken as $E = 2.06 \cdot 10^5$ N/mm ² for steel
M_S	Vertical still water bending moment in seagoing condition, in kNm, at the cross section under consideration
M_{Smax}, M_{Smin}	Permissible maximum and minimum vertical still water bending moments in seagoing condition, in kNm, at the cross section under consideration, see 2.2.2
M_W	Vertical wave induced bending moment, in kNm, at the cross section under consideration
F_S	Vertical still water shear force in seagoing condition, in kN, at the cross section under consideration
F_{Smax}, F_{Smin}	Permissible maximum and minimum still water vertical shear force in seagoing condition, in kN, at the cross section under consideration, see 2.2.2
F_W	Vertical wave induced shear force, in kN, at the cross section under consideration
q_v	Shear flow along the cross section under consideration, to be determined according to Annex 1
f_{NL-Hog}	Non-linear correction factor for hogging, see 2.3.2
f_{NL-Sag}	Non-linear correction factor for sagging, see 2.3.2

S11A (cont)	f_R	Factor related to the operational profile, see 2.3.2
	t_{net}	Net thickness, in mm, see 1.3.1
	t_{res}	Reserve thickness, to be taken as 0.5mm
	I_{net}	Net vertical hull girder moment of inertia at the cross section under consideration, to be determined using net scantlings as defined in 1.3, in m^4
	σ_{HG}	Hull girder bending stress, in N/mm^2 , as defined in 2.5
	τ_{HG}	Hull girder shear stress, in N/mm^2 , as defined in 2.5
	x	Longitudinal co-ordinate of a location under consideration, in m
	z	Vertical co-ordinate of a location under consideration, in m
z_n	Distance from the baseline to the horizontal neutral axis, in m.	

S11A.1.2.2 Fore end and aft end

The fore end (FE) of the rule length L , see Figure 1, is the perpendicular to the scantling draught waterline at the forward side of the stem.

The aft end (AE) of the rule length L , see Figure 1, is the perpendicular to the scantling draught waterline at a distance L aft of the fore end (FE).

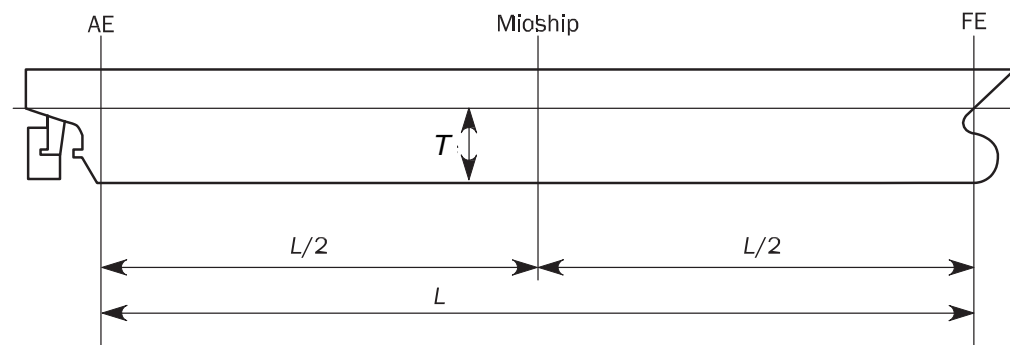

Figure 1: Ends of length L

S11A.1.2.3 Reference coordinate system

The ships geometry, loads and load effects are defined with respect to the following right-hand coordinate system (see Figure 2):

- Origin: At the intersection of the longitudinal plane of symmetry of ship, the aft end of L and the baseline.
- X axis: Longitudinal axis, positive forwards.
- Y axis: Transverse axis, positive towards portside.
- Z axis: Vertical axis, positive upwards.

S11A

(cont)

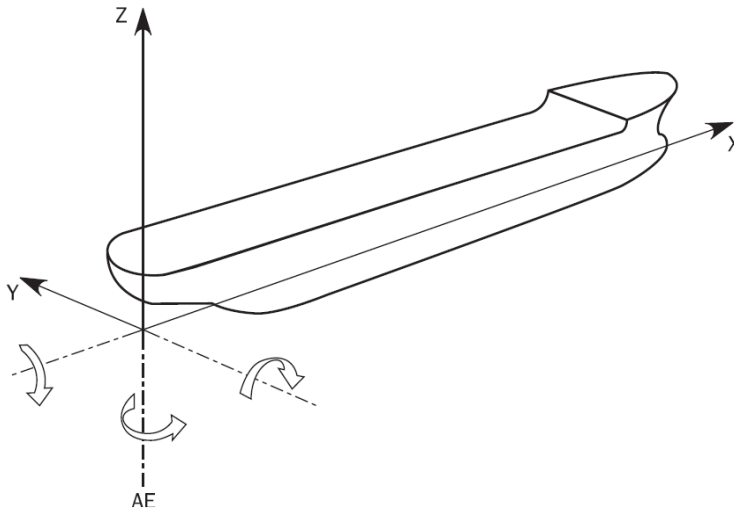

Figure 2: Reference coordinate system

S11A.1.3 Corrosion margin and net thickness

S11A.1.3.1 Net scantling definitions

The strength is to be assessed using the net thickness approach on all scantlings.

The net thickness, t_{net} , for the plates, webs and flanges is obtained by subtracting the voluntary addition t_{vol_add} and the factored corrosion addition t_c from the as built thickness t_{as_built} , as follows:

$$t_{net} = t_{as_built} - t_{vol_add} - \alpha t_c$$

where α is a corrosion addition factor whose values are defined in Table 1.

The voluntary addition, if being used, is to be clearly indicated on the drawings.

Table 1: Values of corrosion addition factor

Structural requirement	Property / analysis type	α
Strength assessment (S11A.3)	Section properties	0.5
Buckling strength (S11A.4)	Section properties (stress determination)	0.5
	Buckling capacity	1.0
Hull girder ultimate strength (S11A.5)	Section properties	0.5
	Buckling / collapse capacity	0.5

S11A.1.3.2 Determination of corrosion addition

The corrosion addition for each of the two sides of a structural member, t_{c1} or t_{c2} is specified in Table 2. The total corrosion addition, t_c , in mm, for both sides of the structural member is obtained by the following formula:

$$t_c = (t_{c1} + t_{c2}) + t_{res}$$

S11A

(cont)

For an internal member within a given compartment, the total corrosion addition, t_c is obtained from the following formula:

$$t_c = (2t_{c1}) + t_{res}$$

The corrosion addition of a stiffener is to be determined according to the location of its connection to the attached plating.

Table 2: Corrosion addition for one side of a structural member

Compartment type	One side corrosion addition t_{c1} or t_{c2} [mm]
Exposed to sea water	1.0
Exposed to atmosphere	1.0
Ballast water tank	1.0
Void and dry spaces	0.5
Fresh water, fuel oil and lube oil tank	0.5
Accommodation spaces	0.0
Container holds	1.0
Compartment types not mentioned above	0.5

S11A.1.3.3 Determination of net section properties

The net section modulus, moment of inertia and shear area properties of a supporting member are to be calculated using the net dimensions of the attached plate, web and flange, as defined in Figure 3. The net cross-sectional area, the moment of inertia about the axis parallel to the attached plate and the associated neutral axis position are to be determined through applying a corrosion magnitude of $0.5 at_c$ deducted from the surface of the profile cross-section.

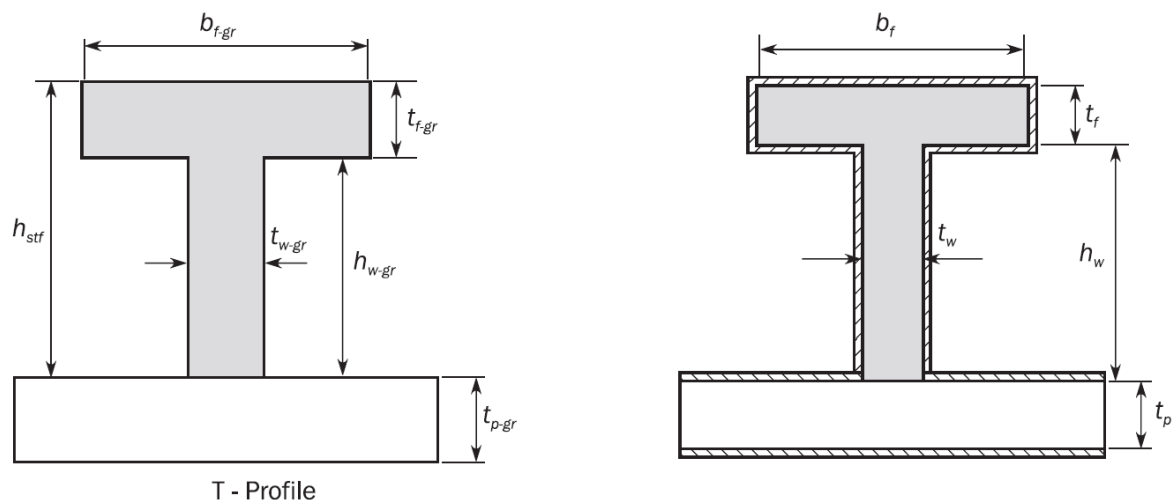

S11A

(cont)

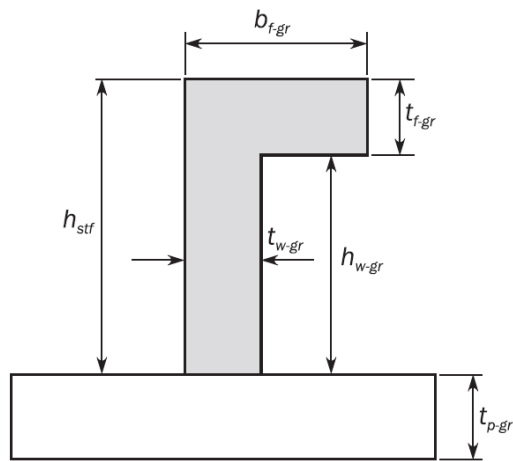

L - Profile

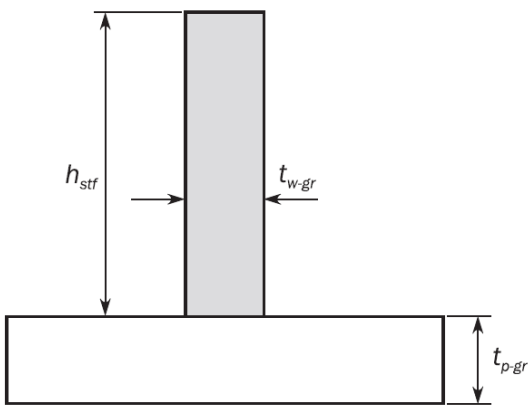
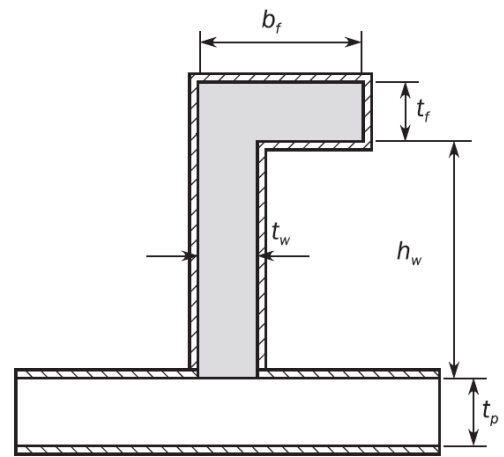

FB - Profile

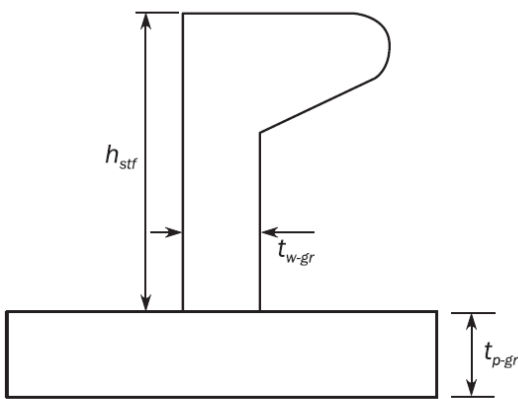
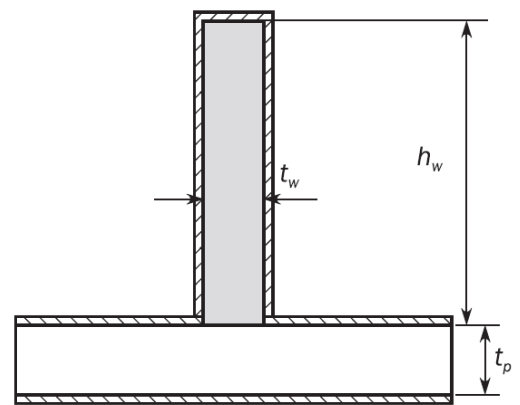

Bulb and similar profiles

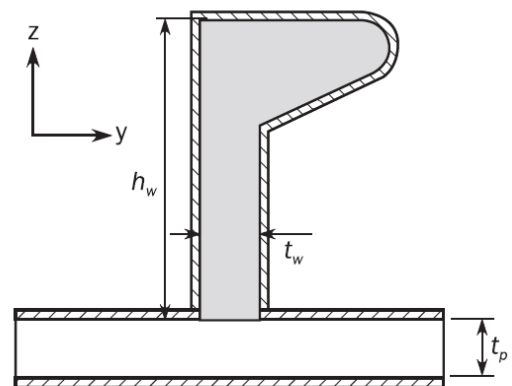

Figure 3: Net sectional properties of supporting members

S11A

(cont)

S11A.2 Loads

S11A.2.1 Sign convention for hull girder loads

The sign conventions of vertical bending moments and vertical shear forces at any ship transverse section are as shown in Figure 4, namely:

- The vertical bending moments M_S and M_W are positive when they induce tensile stresses in the strength deck (hogging bending moment) and negative when they induce tensile stresses in the bottom (sagging bending moment).
- The vertical shear forces F_S , F_W are positive in the case of downward resulting forces acting aft of the transverse section and upward resulting forces acting forward of the transverse section under consideration. The shear forces in the directions opposite to above are negative.

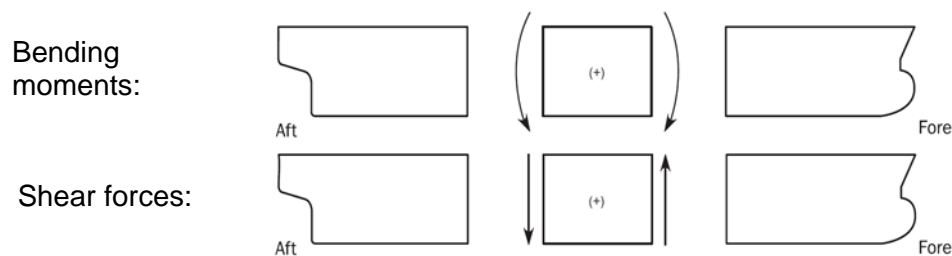

Figure 4: Sign conventions of bending moments and shear forces

S11A
(cont)**S11A.2.2 Still water bending moments and shear forces**

S11A.2.2.1 General

Still water bending moments, M_S in kNm, and still water shear forces, F_S in kN, are to be calculated at each section along the ship length for design loading conditions as specified in 2.2.2.

S11A.2.2.2 Design loading conditions

In general, the design cargo and ballast loading conditions, based on amount of bunker, fresh water and stores at departure and arrival, are to be considered for the M_S and F_S calculations. Where the amount and disposition of consumables at any intermediate stage of the voyage are considered more severe, calculations for such intermediate conditions are to be submitted in addition to those for departure and arrival conditions. Also, where any ballasting and/or de-ballasting is intended during voyage, calculations of the intermediate condition just before and just after ballasting and/or de-ballasting any ballast tank are to be submitted and where approved included in the loading manual for guidance.

The permissible vertical still water bending moments M_{Smax} and M_{Smin} and the permissible vertical still water shear forces F_{Smax} and F_{Smin} in seagoing conditions at any longitudinal position are to envelop:

- The maximum and minimum still water bending moments and shear forces for the seagoing loading conditions defined in the Loading Manual.
- The maximum and minimum still water bending moments and shear forces specified by the designer

The Loading Manual should include the relevant loading conditions, which envelop the still water hull girder loads for seagoing conditions, including those specified in UR S1 Annex 1.

S11A

(cont)

S11A.2.3 Wave loads**S11A.2.3.1 Wave parameter**

The wave parameter is defined as follows:

$$C = 1 - 1.50 \left(1 - \sqrt{\frac{L}{L_{ref}}} \right)^{2.2} \quad \text{for } L \leq L_{ref}$$

$$C = 1 - 0.45 \left(\sqrt{\frac{L}{L_{ref}}} - 1 \right)^{1.7} \quad \text{for } L > L_{ref}$$

where:

L_{ref} Reference length, in m, taken as:

$L_{ref} = 315C_W^{-1.3}$ for the determination of vertical wave bending moments according to 2.3.2

$L_{ref} = 330C_W^{-1.3}$ for the determination of vertical wave shear forces according to 2.3.3

S11A.2.3.2 Vertical wave bending moments

The distribution of the vertical wave induced bending moments, M_W in kNm, along the ship length is given in Figure 6, where:

$$M_{W-Hog} = +1.5 f_R L^3 C C_W \left(\frac{B}{L} \right)^{0.8} f_{NL-Hog}$$

$$M_{W-Sag} = -1.5 f_R L^3 C C_W \left(\frac{B}{L} \right)^{0.8} f_{NL-Sag}$$

where:

f_R : Factor related to the operational profile, to be taken as:
 $f_R = 0.85$

f_{NL-Hog} : Non-linear correction for hogging, to be taken as:
 $f_{NL-Hog} = 0.3 \frac{C_B}{C_W} \sqrt{T}$, not to be taken greater than 1.1

f_{NL-Sag} : Non-linear correction for sagging, to be taken as:
 $f_{NL-Sag} = 4.5 \frac{1 + 0.2 f_{Bow}}{C_W \sqrt{C_B} L^{0.3}}$, not to be taken less than 1.0

S11A

(cont)

f_{Bow} : Bow flare shape coefficient, to be taken as:

$$f_{Bow} = \frac{A_{DK} - A_{WL}}{0.2Lz_f}$$

A_{DK} : Projected area in horizontal plane of uppermost deck, in m^2 including the forecastle deck, if any, extending from $0.8L$ forward (see Figure 5). Any other structures, e.g. plated bulwark, are to be excluded.

A_{WL} : Waterplane area, in m^2 , at draught T , extending from $0.8L$ forward

z_f : Vertical distance, in m, from the waterline at draught T to the uppermost deck (or forecastle deck), measured at FE (see Figure 5). Any other structures, e.g. plated bulwark, are to be excluded.

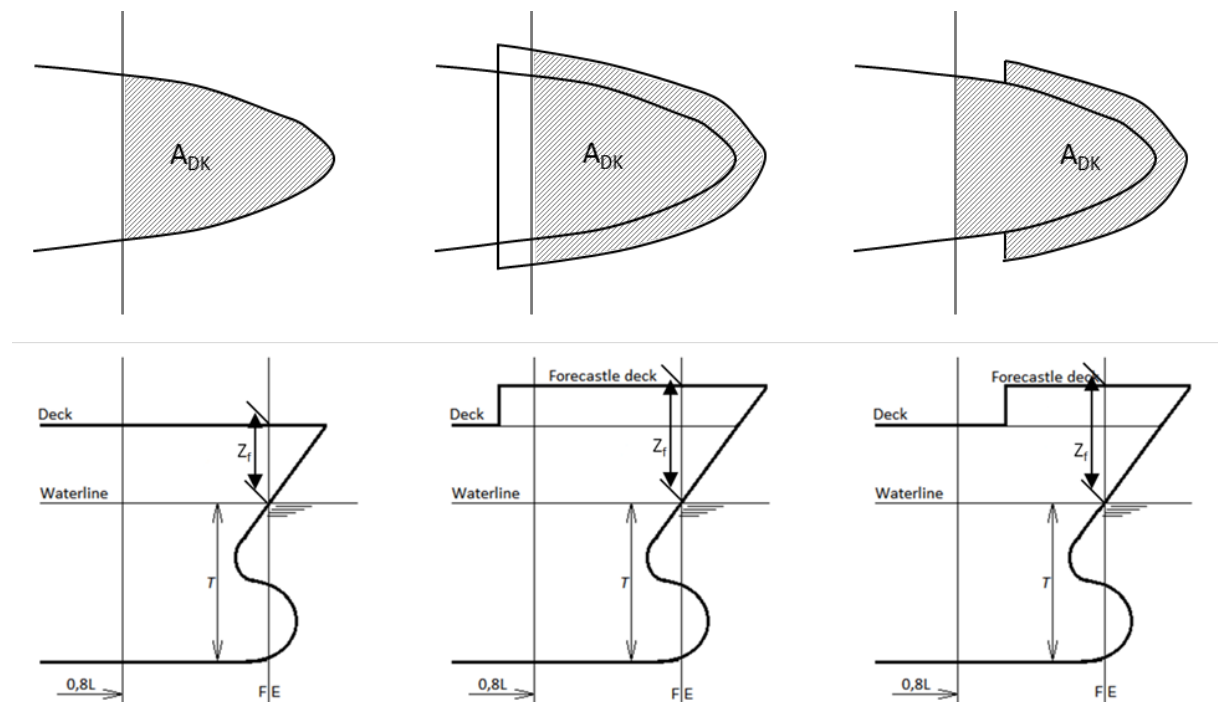

Figure 5: Projected area A_{DK} and vertical distance z_f

S11A
(cont)

Figure 6: Distribution of vertical wave bending moment M_W along the ship length

S11A

(cont)

S11A.2.3.3 Vertical wave shear force

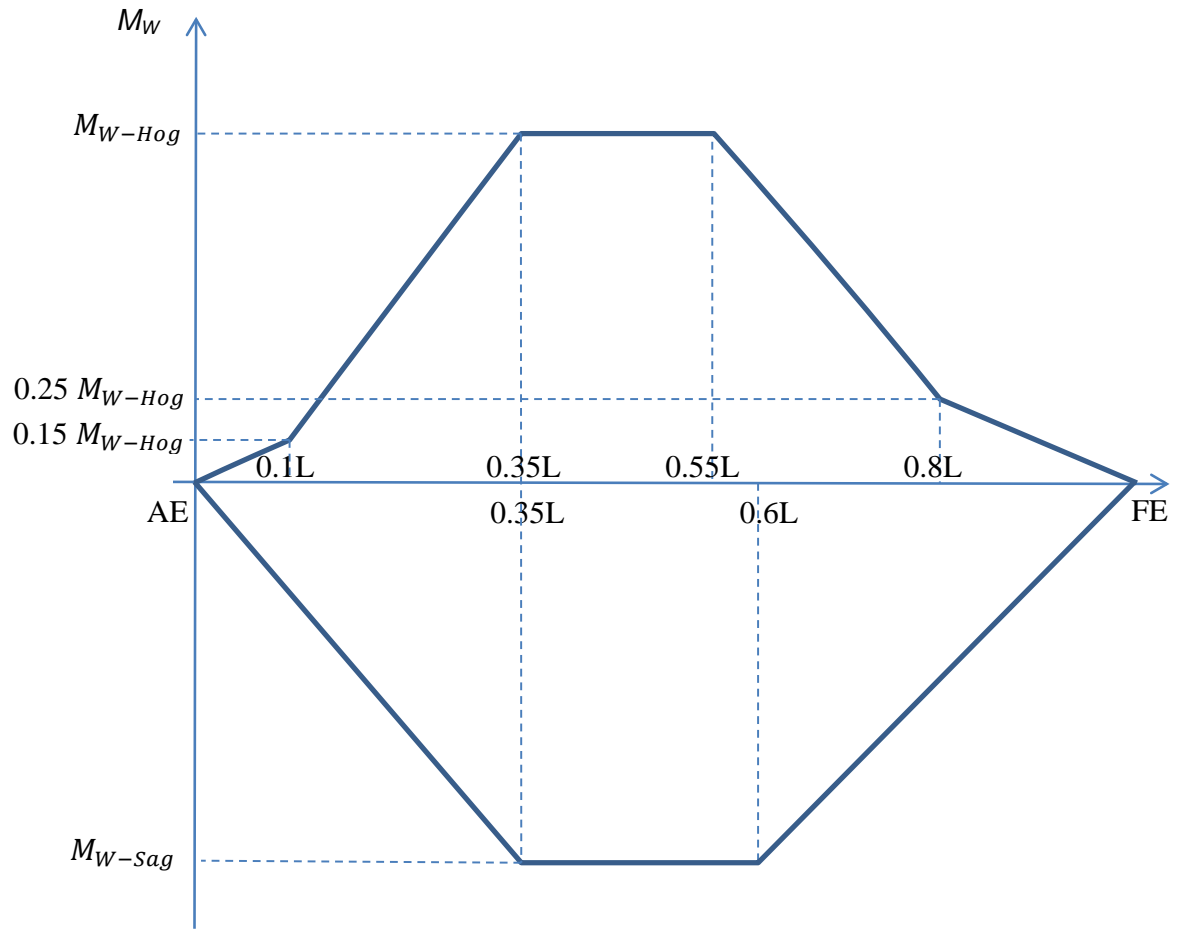
The distribution of the vertical wave induced shear forces, F_W in kN, along the ship length is given in Figure 7, where,

$$F_{W_{Hog}}^{Aft} = +5.2 f_R L^2 C C_W \left(\frac{B}{L} \right)^{0.8} (0.3 + 0.7 f_{NL-Hog})$$

$$F_{W_{Hog}}^{Fore} = -5.7 f_R L^2 C C_W \left(\frac{B}{L} \right)^{0.8} f_{NL-Hog}$$

$$F_{W_{Sag}}^{Aft} = -5.2 f_R L^2 C C_W \left(\frac{B}{L} \right)^{0.8} (0.3 + 0.7 f_{NL-Sag})$$

$$F_{W_{Sag}}^{Fore} = +5.7 f_R L^2 C C_W \left(\frac{B}{L} \right)^{0.8} (0.25 + 0.75 f_{NL-Sag})$$

$$F_W^{Mid} = +4.0 f_R L^2 C C_W \left(\frac{B}{L} \right)^{0.8}$$

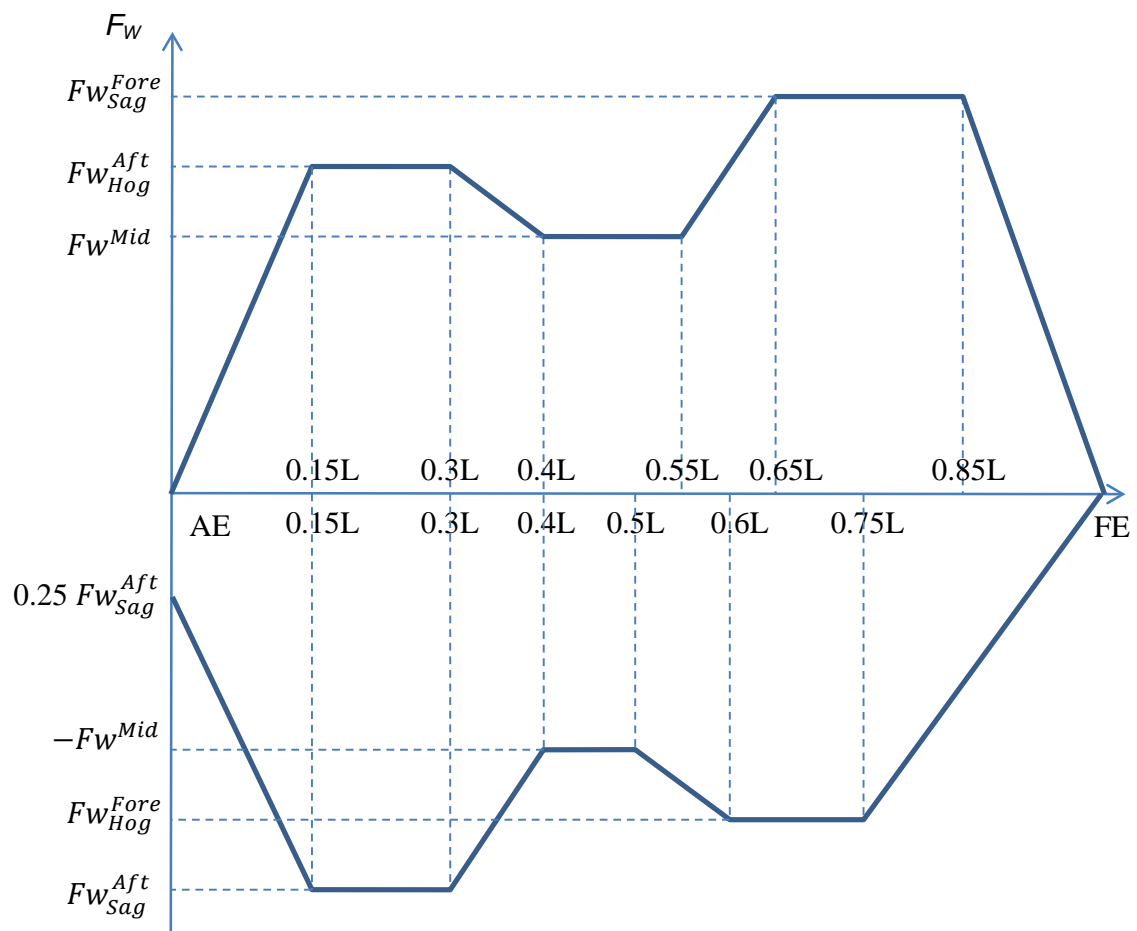

Figure 7: Distribution of vertical wave shear force F_W along the ship length

S11A
(cont)

S11A.2.4 Load cases

For the strength assessment, the maximum hogging and sagging load cases given in Table 3 are to be checked. For each load case the still water condition at each section as defined in 2.2 is to be combined with the wave condition as defined in 2.3, refer also to Figure 8.

Table 3: Combination of still water and wave bending moments and shear forces

Load case	Bending moment		Shear force	
	M_S	M_W	F_S	F_W
Hogging	M_{Smax}	M_{WH}	F_{Smax} for $x \leq 0.5L$ F_{Smin} for $x > 0.5L$	F_{Wmax} for $x \leq 0.5L$ F_{Wmin} for $x > 0.5L$
Sagging	M_{Smin}	M_{WS}	F_{Smin} for $x \leq 0.5L$ F_{Smax} for $x > 0.5L$	F_{Wmin} for $x \leq 0.5L$ F_{Wmax} for $x > 0.5L$

M_{WH} : Wave bending moment in hogging at the cross section under consideration, to be taken as the positive value of M_W as defined in Figure 6.

M_{WS} : Wave bending moment in sagging at the cross section under consideration, to be taken as the negative value of M_W as defined Figure 6.

F_{Wmax} : Maximum value of the wave shear force at the cross section under consideration, to be taken as the positive value of F_W as defined Figure 7.

F_{Wmin} : Minimum value of the wave shear force at the cross section under consideration, to be taken as the negative value of F_W as defined Figure 7.

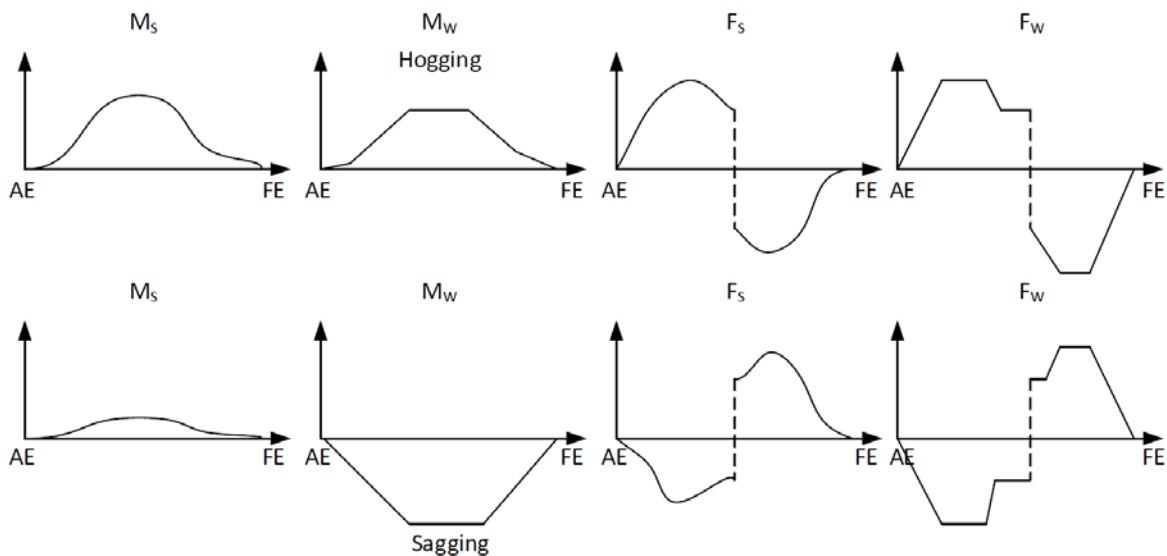

Figure 8: Load combination to determine the maximum hogging and sagging load cases as given in Table 3

S11A

(cont)

S11A.2.5 Hull girder stress

The hull girder stresses in N/mm^2 are to be determined at the load calculation point under consideration, for the “hogging” and “sagging” load cases defined in 2.4 as follows:

Bending stress:

$$\sigma_{HG} = \frac{\gamma_s M_s + \gamma_w M_w}{I_{net}} (Z - Z_n) 10^{-3}$$

Shear stress:

$$\tau_{HG} = \frac{\gamma_s F_s + \gamma_w F_w}{\frac{t_{net}}{q_v}} 10^3$$

where:

γ_s, γ_w : Partial safety factors, to be taken as:

$$\gamma_s = 1.0$$

$$\gamma_w = 1.0$$

S11A.3 Strength Assessment**S11A.3.1 General**

Continuity of structure is to be maintained throughout the length of the ship. Where significant changes in structural arrangement occur adequate transitional structure is to be provided.

S11A.3.2 Stiffness criterion

The two load cases “hogging” and “sagging” as listed in 2.4 are to be checked.

The net moment of inertia, in m^4 , is not to be less than:

$$I_{net} \geq 1.55L |M_s + M_w| 10^{-7}$$

S11A

(cont)

S11A.3.3 Yield strength assessment

S11A.3.3.1 General acceptance criteria

The yield strength assessment is to check, for each of the load cases “hogging” and “sagging” as defined in 2.4, that the equivalent hull girder stress σ_{eq} , in N/mm², is less than the permissible stress σ_{perm} , in N/mm², as follows:

$$\sigma_{eq} < \sigma_{perm}$$

where:

$$\sigma_{eq} = \sqrt{\sigma_x^2 + 3\tau^2}$$

$$\sigma_{perm} = \frac{R_{eH}}{\gamma_1 \gamma_2}$$

γ_1 : Partial safety factor for material, to be taken as: $\gamma_1 = k \frac{R_{eH}}{235}$

γ_2 : Partial safety factor for load combinations and permissible stress, to be taken as:

- $\gamma_2 = 1.24$, for bending strength assessment according to 3.3.2.
- $\gamma_2 = 1.13$, for shear stress assessment according to 3.3.3.

S11A.3.3.2 Bending strength assessment

The assessment of the bending stresses is to be carried out according to 3.3.1 at the following locations of the cross section:

- At bottom
- At deck
- At top of hatch coaming
- At any point where there is a change of steel yield strength

The following combination of hull girder stress as defined in 2.5 is to be considered:

$$\sigma_x = \sigma_{HG}$$

$$\tau = 0$$

S11A.3.3.3 Shear strength assessment

The assessment of shear stress is to be carried out according to 3.3.1 for all structural elements that contribute to the shear strength capability.

The following combination of hull girder stress as defined in 2.5 is to be considered:

$$\sigma_x = 0$$

S11A

(cont)

$$\tau = \tau_{HG}$$

S11A.4 Buckling strength

S11A.4.1 Application

These requirements apply to plate panels and longitudinal stiffeners subject to hull girder bending and shear stresses.

Definitions of symbols used in the present article S11A.4 are given in Annex 2 “Buckling Capacity”.

S11A.4.2 Buckling criteria

The acceptance criterion for the buckling assessment is defined as follows:

$$\eta_{act} \leq 1$$

where:

η_{act} : Maximum utilisation factor as defined in S11A 4.3.

S11A.4.3 Buckling utilisation factor

The utilisation factor, η_{act} , is defined as the inverse of the stress multiplication factor at failure γ_c , see figure 9.

$$\eta_{act} = \frac{1}{\gamma_c}$$

Failure limit states are defined in:

- Annex 2, 2 for elementary plate panels,
- Annex 2, 3 for overall stiffened panels,
- Annex 2, 4 for longitudinal stiffeners.

Each failure limit state is defined by an equation, and γ_c is to be determined such that it satisfies the equation.

Figure 9 illustrates how the stress multiplication factor at failure γ_c , of a structural member is determined for any combination of longitudinal and shear stress. Where:

σ_x, τ : Applied stress combination for buckling given in S11A.4.4.1

σ_c, τ_c : Critical buckling stresses to be obtained according to Annex 2 for the stress combination for buckling σ_x and τ .

S11A

(cont)

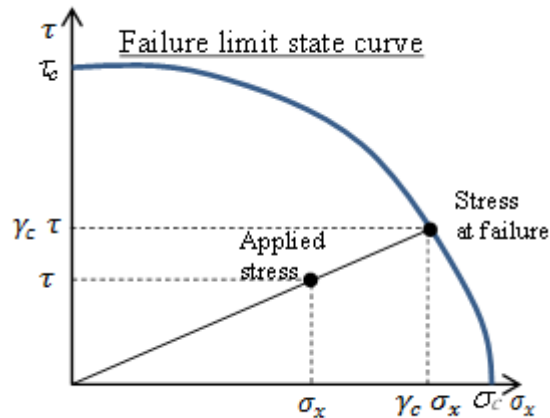

Figure 9: Example of failure limit state curve and stress multiplication factor at failure

S11A.4.4 Stress determination

S11A.4.4.1 Stress combinations for buckling assessment

The following two stress combinations are to be considered for each of the load cases “hogging” and “sagging” as defined in S11A.2.4. The stresses are to be derived at the load calculation points defined in S11A.4.4.2

a) Longitudinal stiffening arrangement:

Stress combination 1 with:

$$\sigma_x = \sigma_{HG}$$

$$\sigma_y = 0$$

$$\tau = 0.7\tau_{HG}$$

Stress combination 2 with:

$$\sigma_x = 0.7\sigma_{HG}$$

$$\sigma_y = 0$$

$$\tau = \tau_{HG}$$

b) Transverse stiffening arrangement:

Stress combination 1 with:

$$\sigma_x = 0$$

$$\sigma_y = \sigma_{HG}$$

$$\tau = 0.7\tau_{HG}$$

Stress combination 2 with:

S11A

(cont)

$$\sigma_x = 0$$

$$\sigma_y = 0.7\sigma_{HG}$$

$$\tau = \tau_{HG}$$

S11A.4.4.2 Load calculation points

The hull girder stresses for elementary plate panels (EPP) are to be calculated at the load calculation points defined in Table 4.

Table 4: Load calculation points (LCP) coordinates for plate buckling assessment

LCP coordinates	Hull girder bending stress		Hull girder shear stress
	Non horizontal plating	Horizontal plating	
x coordinate	Mid-length of the EPP		
y coordinate	Both upper and lower ends of the EPP (points A1 and A2 in Figure 10)	Outboard and inboard ends of the EPP (points A1 and A2 in Figure 10)	Mid-point of EPP (point B in Figure 10)
z coordinate	Corresponding to x and y values		

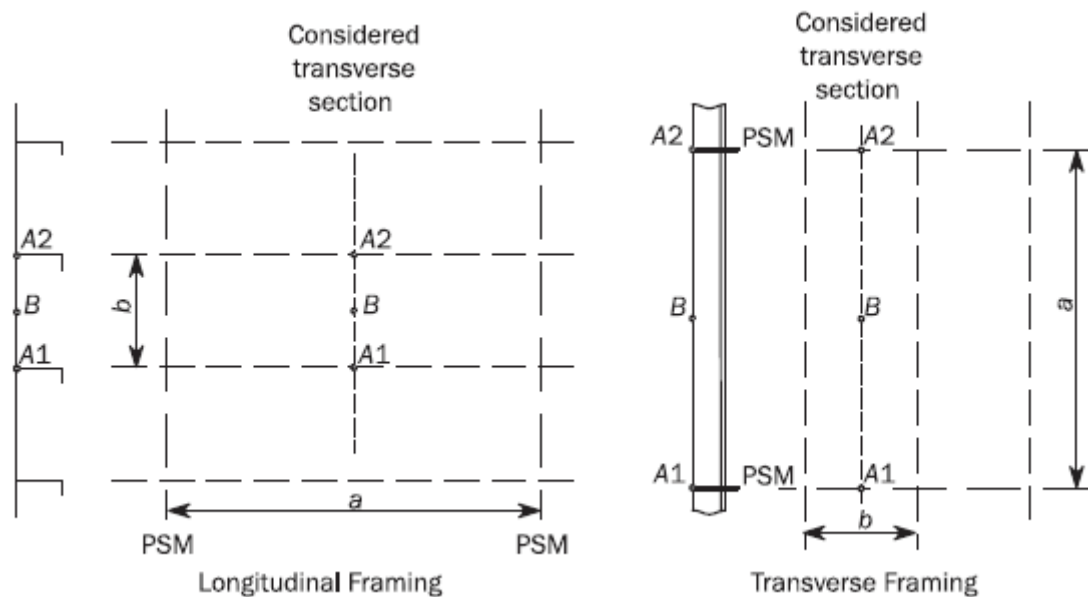

Figure 10: LCP for plate buckling – assessment, PSM stands for primary supporting members

The hull girder stresses for longitudinal stiffeners are to be calculated at the following load calculation point:

- at the mid length of the considered stiffener.
- at the intersection point between the stiffener and its attached plate.

S11A

(cont)

S11A.5 Hull girder ultimate strength

S11A.5.1 General

The hull girder ultimate strength is to be assessed for ships with length L equal or greater than 150m.

The acceptance criteria, given in 5.4 are applicable to intact ship structures.

The hull girder ultimate bending capacity is to be checked for the load cases “hogging” and “sagging” as defined in 2.4.

S11A.5.2 Hull girder ultimate bending moments

The vertical hull girder bending moment, M in hogging and sagging conditions, to be considered in the ultimate strength check is to be taken as:

$$M = \gamma_s M_s + \gamma_w M_w$$

where:

M_s = Permissible still water bending moment, in kNm, defined in 2.4

M_w = Vertical wave bending moment, in kNm, defined in 2.4.

γ_s = Partial safety factor for the still water bending moment, to be taken as:

$$\gamma_s = 1.0$$

γ_w = Partial safety factor for the vertical wave bending moment, to be taken as:

$$\gamma_w = 1.2$$

S11A.5.3 Hull girder ultimate bending capacity

S11A.5.3.1 General

The hull girder ultimate bending moment capacity, M_U is defined as the maximum bending moment capacity of the hull girder beyond which the hull structure collapses.

S11A.5.3.2 Determination of hull girder ultimate bending moment capacity

The ultimate bending moment capacities of a hull girder transverse section, in hogging and sagging conditions, are defined as the maximum values of the curve of bending moment M versus the curvature χ of the transverse section considered (M_{UH} for hogging condition and M_{US} for sagging condition, see Figure 11). The curvature χ is positive for hogging condition and negative for sagging condition.

S11A

(cont)

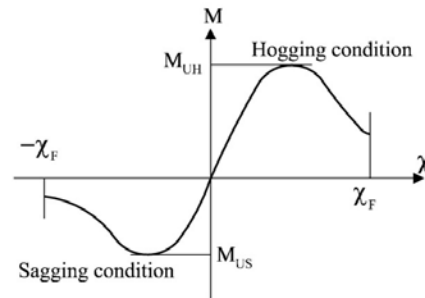

Figure 11: Bending moment M versus curvature χ

The hull girder ultimate bending moment capacity M_U is to be calculated using the incremental-iterative method as given in 2 of Annex 3 or using an alternative method as indicated in 3 of Annex 3.

S11A.5.4 Acceptance criteria

The hull girder ultimate bending capacity at any hull transverse section is to satisfy the following criteria:

$$M \leq \frac{M_U}{\gamma_M \gamma_{DB}}$$

where:

M = Vertical bending moment, in kNm, to be obtained as specified in 5.2.

M_U = Hull girder ultimate bending moment capacity, in kNm, to be obtained as specified in 5.3.

γ_M = Partial safety factor for the hull girder ultimate bending capacity, covering material, geometric and strength prediction uncertainties, to be taken as:
 $\gamma_M = 1.05$

γ_{DB} = Partial safety factor for the hull girder ultimate bending moment capacity, covering the effect of double bottom bending, to be taken as:

- For hogging condition: $\gamma_{DB} = 1.15$
- For sagging condition: $\gamma_{DB} = 1.0$

For cross sections where the double bottom breadth of the inner bottom is less than that at amidships or where the double bottom structure differs from that at amidships (e.g. engine room sections), the factor γ_{DB} for hogging condition may be reduced based upon agreement with the Classification Society.

S11A
(cont)**S11A.6 Additional requirements for large container ships****S11A.6.1 General**

The requirements in S11A.6.2 and S11A.6.3 are applicable, in addition to requirements in S11A.3 to S11A.5, to container ships with a breadth B greater than 32.26 m.

S11A.6.2 Yielding and buckling assessment

Yielding and buckling assessments are to be carried out in accordance with the Rules of the Classification Society, taking into consideration additional hull girder loads (wave torsion, wave horizontal bending and static cargo torque), as well as local loads. All in-plane stress components (i.e. bi-axial and shear stresses) induced by hull girder loads and local loads are to be considered.

S11A.6.3 Whipping

Hull girder ultimate strength assessment is to take into consideration the whipping contribution to the vertical bending moment according to the Classification Society procedures.

S11A Annex 1 – Calculation of shear flow

(cont)

1. General

This annex describes the procedures of direct calculation of shear flow around a ship's cross section due to hull girder vertical shear force. The shear flow q_v at each location in the cross section, is calculated by considering the cross section is subjected to a unit vertical shear force of 1 N.

The unit shear flow per mm, q_v , in N/mm, is to be taken as:

$$q_v = q_D + q_I$$

where:

q_D : Determinate shear flow, as defined in 2.

q_I : Indeterminate shear flow which circulates around the closed cells, as defined in 3.

In the calculation of the unit shear flow, q_v , the longitudinal stiffeners are to be taken into account.

2. Determinate shear flow

The determinate shear flow, q_D , in N/mm at each location in the cross section is to be obtained from the following line integration:

$$q_D(s) = -\frac{1}{10^6 I_{y-net}} \int_0^s (z - z_n) t_{net} d_s$$

where:

s : Coordinate value of running coordinate along the cross section, in m.

I_{y-net} : Net moment of inertia of the cross section, in m^4 .

t_{net} : Net thickness of plating, in mm.

z_n : Z coordinate of horizontal neutral axis from baseline, in m.

It is assumed that the cross section is composed of line segments as shown in Figure 1: where each line segment has a constant plate net thickness. The determinate shear flow is obtained by the following equation.

$$q_{Dk} = -\frac{t_{net} \ell}{2 \cdot 10^6 I_{Y-net}} (z_k + z_i - 2z_n) + q_{Di}$$

where:

q_{Dk}, q_{Di} : Determinate shear flow at node k and node i respectively, in N/mm.

S11A**(cont)**

- ℓ : Length of line segments, in m.
- y_k, y_i : Y coordinate of the end points k and i of line segment, in m, as defined in Figure 1.
- z_k, z_i : Z coordinate of the end points k and i of line segment, in m, as defined in Figure 1 .

Where the cross section includes closed cells, the closed cells are to be cut with virtual slits, as shown in Figure 2: in order to obtain the determinate shear flow.

These virtual slits must not be located in walls which form part of another closed cell.

Determinate shear flow at bifurcation points is to be calculated by water flow calculations, or similar, as shown in Figure 2.

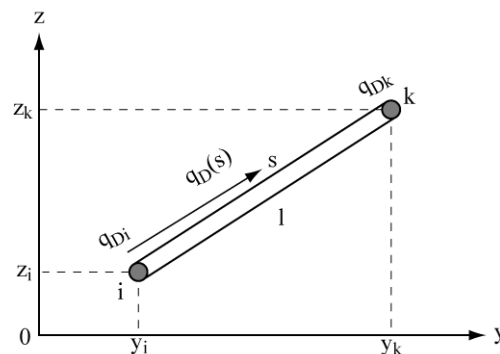

Figure 1: Definition of line segment

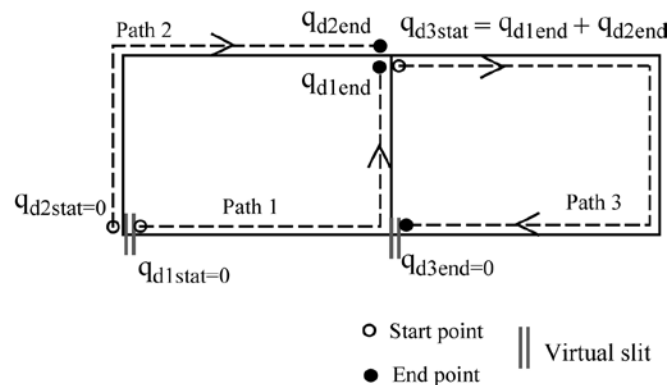

Figure 2: Placement of virtual slits and calculation of determinate shear flow at bifurcation points

3. Indeterminate shear flow

The indeterminate shear flow around closed cells of a cross section is considered as a constant value within the same closed cell. The following system of equation for determination of indeterminate shear flows can be developed. In the equations, contour integrations of several parameters around all closed cells are performed.

S11A
(cont)

$$q_{Ic} \oint_C \frac{1}{t_{net}} ds - \sum_{m=1}^{N_w} \left(q_{Im} \oint_{c\&m} \frac{1}{t_{net}} ds \right) = - \oint_c \frac{q_D}{t_{net}} ds$$

where:

N_w : Number of common walls shared by cell c and all other cells.

$c\&m$: Common wall shared by cells c and m

q_{Ic}, q_{Im} : Indeterminate shear flow around the closed cell c and m respectively, in N/mm.

Under the assumption of the assembly of line segments shown in Figure 1 and constant plate thickness of each line segment, the above equation can be expressed as follows:

$$q_{Ic} \sum_{j=1}^{N_c} \left(\frac{\ell}{t_{net}} \right)_j - \sum_{m=1}^{N_w} \left\{ q_{Im} \left[\sum_{j=1}^{N_m} \left(\frac{\ell}{t_{net}} \right)_j \right]_m \right\} = - \sum_{j=1}^{N_c} \phi_j$$

$$\phi_j = \left[- \frac{\ell^2}{6 \cdot 10^3 I_{Y-net}} (z_k + 2z_i - 3z_n) + \frac{\ell}{t_{net}} q_{Di} \right]_j$$

where:

N_c : Number of line segments in cell c .

N_m : Number of line segments on the common wall shared by cells c and m .

q_{Di} : Determinate shear flow, in N/mm, calculated according to Annex 1, 2.

The difference in the directions of running coordinates specified in Annex 1, 2 and in this section has to be considered.

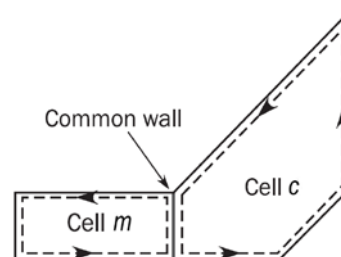

Figure 3: Closed cells and common wall

4. Computation of sectional properties

Properties of the cross section are to be obtained by the following formulae where the cross section is assumed as the assembly of line segments:

S11A

(cont)

$$\ell = \sqrt{(y_k - y_i)^2 + (z_k - z_i)^2}$$

$$a_{net} = 10^{-3} \ell t_{net} \qquad A_{net} = \sum a_{net}$$

$$s_{y-net} = \frac{a_{net}}{2} (z_k + z_i) \qquad S_{y-net} = \sum s_{y-net}$$

$$i_{y0-net} = \frac{a_{net}}{3} (z_k^2 + z_k z_i + z_i^2) \qquad I_{y0-net} = \sum i_{y0-net}$$

where:

a_{net}, A_{net} : Area of the line segment and the cross section respectively, in m^2 .

s_{y-net}, S_{y-net} : First moment of the line segment and the cross section about the baseline, in m^3 .

i_{y0-net}, I_{y0-net} : Moment of inertia of the line segment and the cross section about the baseline, in m^4 .

The height of horizontal neutral axis, z_n , in m, is to be obtained as follows:

$$z_n = \frac{S_{y-net}}{A_{net}}$$

Inertia moment about the horizontal neutral axis, in m^4 , is to be obtained as follows:

$$I_{y-net} = I_{y0-net} - z_n^2 A_{net}$$

Annex 2 – Buckling Capacity

Symbols

x axis	: Local axis of a rectangular buckling panel parallel to its long edge.
y axis	: Local axis of a rectangular buckling panel perpendicular to its long edge.
σ_x	: Membrane stress applied in x direction, in N/mm^2 .
σ_y	: Membrane stress applied in y direction, in N/mm^2 .
τ	: Membrane shear stress applied in xy plane, in N/mm^2 .
σ_a	: Axial stress in the stiffener, in N/mm^2
σ_b	: Bending stress in the stiffener, in N/mm^2
σ_w	: Warping stress in the stiffener, in N/mm^2
$\sigma_{cx}, \sigma_{cy}, \tau_c$: Critical stress, in N/mm^2 , defined in [2.1.1] for plates.
R_{eH_S}	: Specified minimum yield stress of the stiffener, in N/mm^2
R_{eH_P}	: Specified minimum yield stress of the plate, in N/mm^2
a	: Length of the longer side of the plate panel as shown in Table 2, in mm.
b	: Length of the shorter side of the plate panel as shown in Table 2, in mm.
d	: Length of the side parallel to the axis of the cylinder corresponding to the curved plate panel as shown in Table 3, in mm.
σ_E	: Elastic buckling reference stress, in N/mm^2 to be taken as: <ul style="list-style-type: none"> For the application of plate limit state according to [2.1.2]: $\sigma_E = \frac{\pi^2 E}{12(1-\nu^2)} \left(\frac{t_p}{b}\right)^2$ For the application of curved plate panels according to [2.2]: $\sigma_E = \frac{\pi^2 E}{12(1-\nu^2)} \left(\frac{t_p}{d}\right)^2$
ν	: Poisson's ratio to be taken equal to 0.3
t_p	: Net thickness of plate panel, in mm
t_w	: Net stiffener web thickness, in mm
t_f	: Net flange thickness, in mm
b_f	: Breadth of the stiffener flange, in mm
h_w	: Stiffener web height, in mm
e_f	: Distance from attached plating to centre of flange, in mm, to be taken as: $e_f = h_w$ for flat bar profile. $e_f = h_w - 0.5 t_f$ for bulb profile. $e_f = h_w + 0.5 t_f$ for angle and Tee profiles.
α	: Aspect ratio of the plate panel, to be taken as $\alpha = \frac{a}{b}$
β	: Coefficient taken as $\beta = \frac{1-\psi}{\alpha}$
ψ	: Edge stress ratio to be taken as $\psi = \frac{\sigma_2}{\sigma_1}$
σ_1	: Maximum stress, in N/mm^2
σ_2	: Minimum stress, in N/mm^2
R	: Radius of curved plate panel, in mm
l	: Span, in mm, of stiffener equal to the spacing between primary supporting members
s	: Spacing of stiffener, in mm, to be taken as the mean spacing between the stiffeners of the considered stiffened panel.

1. Elementary Plate Panel (EPP)

1.1 Definition

An Elementary Plate Panel (EPP) is the unstiffened part of the plating between stiffeners and/or primary supporting members.

All the edges of the elementary plate panel are forced to remain straight (but free to move in the in-plane directions) due to the surrounding structure/neighbouring plates (usually longitudinal stiffened panels in deck, bottom and inner-bottom plating, shell and longitudinal bulkheads).

1.2 EPP with different thicknesses

1.2.1 Longitudinally stiffened EPP with different thicknesses

In longitudinal stiffening arrangement, when the plate thickness varies over the width, b , in mm, of a plate panel, the buckling capacity is calculated on an equivalent plate panel width, having a thickness equal to the smaller plate thickness, t_1 . The width of this equivalent plate panel, b_{eq} , in mm, is defined by the following formula:

$$b_{eq} = \ell_1 + \ell_2 \left(\frac{t_1}{t_2} \right)^{1.5}$$

where:

ℓ_1 : Width of the part of the plate panel with the smaller plate thickness, t_1 , in mm, as defined in Figure 1.

ℓ_2 : Width of the part of the plate panel with the greater plate thickness, t_2 , in mm, as defined in Figure 1.

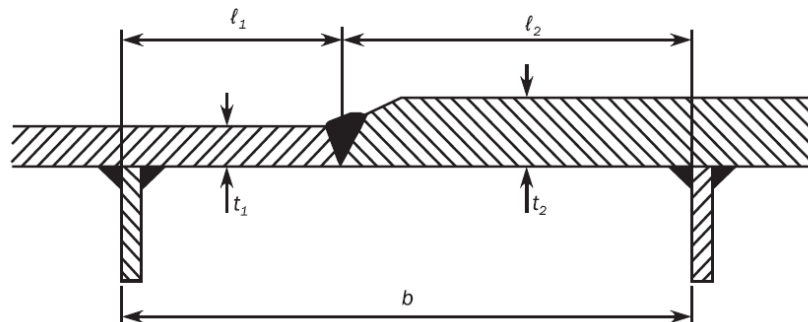

Figure 1: Plate thickness change over the width

1.2.2 Transversally stiffened EPP with different thicknesses

In transverse stiffening arrangement, when an EPP is made of different thicknesses, the buckling check of the plate and stiffeners is to be made for each thickness considered constant on the EPP.

2. Buckling capacity of plates

2.1 Plate panel

2.1.1 Plate limit state

The plate limit state is based on the following interaction formulae:

a) Longitudinal stiffening arrangement:

$$\left(\frac{\gamma_c \sigma_x}{\sigma_{cx}}\right)^{2/\beta_p^{0.25}} + \left(\frac{\gamma_c |\tau|}{\tau_c}\right)^{2/\beta_p^{0.25}} = 1$$

b) Transverse stiffening arrangement:

$$\left(\frac{\gamma_c \sigma_y}{\sigma_{cy}}\right)^{2/\beta_p^{0.25}} + \left(\frac{\gamma_c |\tau|}{\tau_c}\right)^{2/\beta_p^{0.25}} = 1$$

where:

σ_x, σ_y : Applied normal stress to the plate panel in N/mm², as defined in S11A 4.4, at load calculation points of the considered elementary plate panel.

τ : Applied shear stress to the plate panel, in N/mm², as defined in S11A 4.4, at load calculation points of the considered elementary plate panel.

σ_{cx} : Ultimate buckling stress in N/mm² in direction parallel to the longer edge of the buckling panel as defined in 2.1.3

σ_{cy} : Ultimate buckling stress in N/mm² in direction parallel to the shorter edge of the buckling panel as defined in 2.1.3

τ_c : Ultimate buckling shear stress, in N/mm² as defined in 2.1.3

β_p : Plate slenderness parameter taken as:

$$\beta_p = \frac{b}{t_p} \sqrt{\frac{R_{eH-P}}{E}}$$

2.1.2 Reference degree of slenderness

The reference degree of slenderness is to be taken as:

$$\lambda = \sqrt{\frac{R_{eH-P}}{K \sigma_E}}$$

where:

K : Buckling factor, as defined in Table 2 and Table 3.

2.1.3 Ultimate buckling stresses

The ultimate buckling stress of plate panels, in N/mm², is to be taken as:

$$\sigma_{cx} = C_x R_{eH-P}$$

$$\sigma_{cy} = C_y R_{eH-P}$$

The ultimate buckling stress of plate panels subject to shear, in N/mm², is to be taken as:

S11A

(cont)

$$\tau_c = C_\tau \frac{R_{eH-P}}{\sqrt{3}}$$

where:

C_x, C_y, C_τ : Reduction factors, as defined in Table 2

The boundary conditions for plates are to be considered as simply supported (see cases 1, 2 and 15 of Table 2). If the boundary conditions differ significantly from simple support, a more appropriate boundary condition can be applied according to the different cases of Table 2 subject to the agreement of the Classification Society.

2.1.4 Correction Factor F_{long}

The correction factor F_{long} depending on the edge stiffener types on the longer side of the buckling panel is defined in Table 1. An average value of F_{long} is to be used for plate panels having different edge stiffeners. For stiffener types other than those mentioned in Table 1, the value of c is to be agreed by the Society. In such a case, value of c higher than those mentioned in Table 1 can be used, provided it is verified by buckling strength check of panel using non-linear FE analysis and deemed appropriate by the Classification Society.

Table 1: Correction Factor F_{long}

Structural element types		F_{long}	c	
Unstiffened Panel		1.0	N/A	
Stiffened Panel	Stiffener not fixed at both ends	1.0	N/A	
	Stiffener fixed at both ends	Flat bar ⁽¹⁾	$F_{long} = c + 1 \quad \text{for} \quad \frac{t_w}{t_p} > 1$	0.10
		Bulb profile		0.30
		Angle profile		0.40
		T profile	$F_{long} = c \left(\frac{t_w}{t_p} \right)^3 + 1 \quad \text{for} \quad \frac{t_w}{t_p} \leq 1$	0.30
Girder of high rigidity (e.g. bottom transverse)		1.4	N/A	

⁽¹⁾ t_w is the net web thickness, in mm, without the correction defined in 4.3.5

Table 2: Buckling Factor and reduction factor for plane plate panels

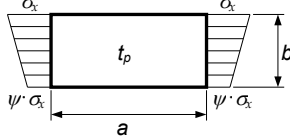
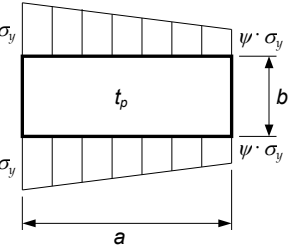
Case	Stress ratio ψ	Aspect ratio α	Buckling factor K	Reduction factor C	
1 	$1 \geq \psi \geq 0$		$K_x = F_{long} \frac{8.4}{\psi + 1.1}$	$C_x = 1$ for $\lambda \leq \lambda_c$ $C_x = c \left(\frac{1}{\lambda} - \frac{0.22}{\lambda^2} \right)$ for $\lambda > \lambda_c$	
	$0 > \psi \geq -1$		$K_x = F_{long} [7.63 - \psi (6.26 - 10\psi)]$	where: $c = (1.25 - 0.12\psi) \leq 1.25$ $\lambda_c = \frac{c}{2} \left(1 + \sqrt{1 - \frac{0.88}{c}} \right)$	
	$\psi < -1$		$K_x = F_{long} [5.975(1 - \psi)^2]$		
2 	$1 \geq \psi \geq 0$		$K_y = \frac{2 \left(1 + \frac{1}{\alpha^2} \right)^2}{1 + \psi + \frac{(1 - \psi)}{100} \left(\frac{2.4}{\alpha^2} + 6.9f_1 \right)}$	$C_y = c \left(\frac{1}{\lambda} - \frac{R + F^2(H - R)}{\lambda^2} \right)$ where: $c = (1.25 - 0.12\psi) \leq 1.25$ $R = \lambda(1 - \lambda/c)$ for $\lambda < \lambda_c$ $R = 0.22$ for $\lambda \geq \lambda_c$ $\lambda_c = 0.5c \left(1 + \sqrt{1 - 0.88/c} \right)$ $F = \left(1 - \left(\frac{K}{0.91} - 1 \right) / \lambda_p^2 \right) c_1 \geq 0$ $\lambda_p^2 = \lambda^2 - 0.5$ for $1 \leq \lambda_p^2 \leq 3$	
		$\alpha \leq 6$	$f_1 = (1 - \psi)(\alpha - 1)$		
		$\alpha > 6$	$f_1 = 0.6 \left(1 - \frac{6\psi}{\alpha} \right) \left(\alpha + \frac{14}{\alpha} \right)$ But not greater than $14.5 - \frac{0.35}{\alpha^2}$		
	$0 > \psi \geq 1 - 4\alpha/3$		$K_y = \frac{200(1 + \beta^2)^2}{(1 - f_3)(100 + 2.4\beta^2 + 6.9f_1 + 23f_2)}$		$c_1 = \left(1 - \frac{1}{\alpha} \right) \geq 0$ $H = \lambda - \frac{2\lambda}{c(T + \sqrt{T^2 - 4})} \geq R$ $T = \lambda + \frac{14}{15\lambda} + \frac{1}{3}$
		$\alpha > 6(1 - \psi)$	$f_1 = 0.6 \left(\frac{1}{\beta} + 14\beta \right)$ but not greater than $14.5 - 0.35\beta^2$ $f_2 = f_3 = 0$		
		$\frac{3(1 - \psi) \leq \alpha \leq 6(1 - \psi)}{6(1 - \psi)}$	$f_1 = \frac{1}{\beta} - 1$ $f_2 = f_3 = 0$		
		$\frac{1.5(1 - \psi) \leq \alpha < 3(1 - \psi)}{3(1 - \psi)}$	$f_1 = \frac{1}{\beta} - (2 - \omega\beta)^4 - 9(\omega\beta - 1) \left(\frac{2}{3} - \beta \right)$ $f_2 = f_3 = 0$		

S11A

(cont)

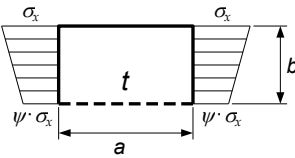
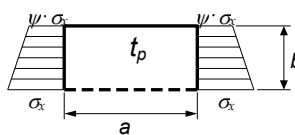
Case	Stress ratio ψ	Aspect ratio α	Buckling factor K	Reduction factor C
		$1 - \psi \leq \alpha < 1.5(1 - \psi)$	For $\alpha > 1.5$: $f_1 = 2 \left(\frac{1}{\beta} - 16 \left(1 - \frac{\psi}{3} \right)^4 \right) \left(\frac{1}{\beta} - 1 \right)$ $f_2 = 3\beta - 2$ $f_3 = 0$ For $\alpha \leq 1.5$: $f_1 = 2 \left(\frac{1.5}{1 - \psi} - 1 \right) \left(\frac{1}{\beta} - 1 \right)$ $f_2 = \frac{\psi(1 - 16f_4^2)}{1 - \alpha}$ $f_3 = 0$ $f_4 = (1.5 - \text{Min}(1.5; \alpha))^2$	
		$0.75(1 - \psi) \leq \alpha < 1 - \psi$	$f_1 = 0$ $f_2 = 1 + 2.31(\beta - 1) - 48 \left(\frac{4}{3} - \beta \right) f_4^2$ $f_3 = 3f_4(\beta - 1) \left(\frac{f_4}{1.81} - \frac{\alpha - 1}{1.31} \right)$ $f_4 = (1.5 - \text{Min}(1.5; \alpha))^2$	
	$\psi < 1 - 4\alpha/3$		$K_y = 5.972 \frac{\beta^2}{1 - f_3}$ where: $f_3 = f_5 \left(\frac{f_5}{1.81} + \frac{1 + 3\psi}{5.24} \right)$ $f_5 = \frac{9}{16} (1 + \text{Max}(-1; \psi))^2$	
3		$1 \geq \psi \geq 0$	$K_x = \frac{4(0.425 + 1/\alpha^2)}{3\psi + 1}$	
		$0 > \psi \geq -1$	$K_x = 4(0.425 + 1/\alpha^2)(1 + \psi) - 5\psi(1 - 3.42\psi)$	$C_x = 1 \quad \text{for } \lambda \leq 0.7$ $C_x = \frac{1}{\lambda^2 + 0.51} \quad \text{for } \lambda > 0.7$
4		$1 \geq \psi \geq -1$	$K_x = \left(0.425 + \frac{1}{\alpha^2} \right) \frac{3 - \psi}{2}$	
				

S11A

(cont)

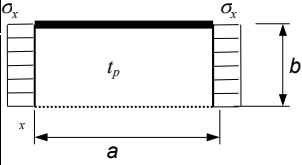
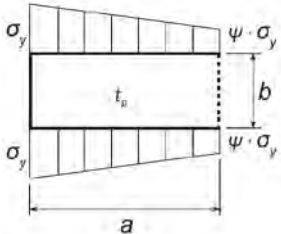
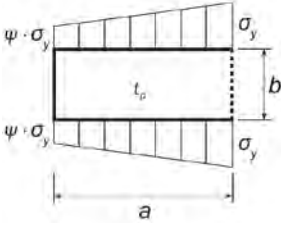
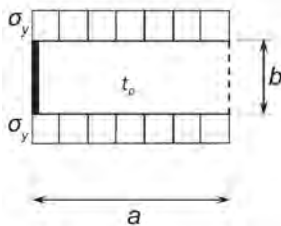
Case	Stress ratio ψ	Aspect ratio α	Buckling factor K	Reduction factor C
5 	-	$\alpha \geq 1.64$	$K_x = 1.28$	$C_y = 1$ for $\lambda \leq 0.7$ $C_y = \frac{1}{\lambda^2 + 0.51}$ for $\lambda > 0.7$
		$\alpha < 1.64$	$K_x = \frac{1}{\alpha^2} + 0.56 + 0.13\alpha^2$	
6 	$1 \geq \psi \geq 0$ $0 > \psi \geq -1$		$K_y = \frac{4(0.425 + \alpha^2)}{(3\psi + 1)\alpha^2}$	
			$K_y = 4(0.425 + \alpha^2)(1 + \psi) \frac{1}{\alpha^2}$ $-5\psi(1 - 3.42\psi) \frac{1}{\alpha^2}$	
7 	$1 \geq \psi \geq -1$		$K_y = (0.425 + \alpha^2) \frac{(3 - \psi)}{2\alpha^2}$	
8 	-		$K_y = 1 + \frac{0.56}{\alpha^2} + \frac{0.13}{\alpha^4}$	

S11A

(cont)

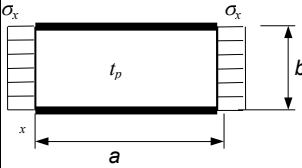
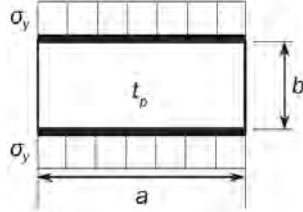
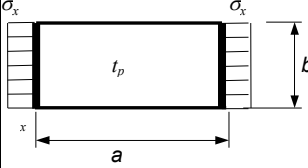
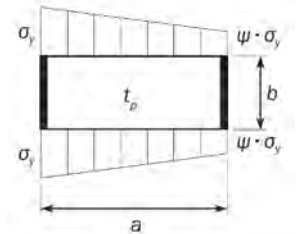
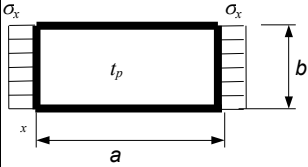
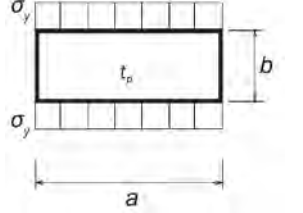
Case	Stress ratio ψ	Aspect ratio α	Buckling factor K	Reduction factor C
9 	-		$K_x = 6.97$	
10 	-		$K_y = 4 + \frac{2.07}{\alpha^2} + \frac{0.67}{\alpha^4}$	$C_x = 1$ for $\lambda \leq 0.83$ $C_x = 1.13 \left[\frac{1}{\lambda} - \frac{0.22}{\lambda^2} \right]$ for $\lambda > 0.83$
11 	-	$\alpha \geq 4$	$K_x = 4$	
		$\alpha < 4$	$K_x = 4 + 2.74 \left(\frac{4 - \alpha}{3} \right)^4$	
12 	-		$K_y = K_y$ determined as per case 2	<ul style="list-style-type: none"> For $\alpha < 2$: $C_y = C_{y2}$ For $\alpha \geq 2$: $C_y = \left(1.06 + \frac{1}{10\alpha} \right) C_{y2}$ where: $C_{y2} = C_y$ determined as per case 2
13 	-	$\alpha \geq 4$	$K_x = 6.97$	$C_x = 1$ for $\lambda \leq 0.83$ $C_x = 1.13 \left[\frac{1}{\lambda} - \frac{0.22}{\lambda^2} \right]$ for $\lambda > 0.83$
		$\alpha < 4$	$K_x = 6.97 + 3.1 \left(\frac{4 - \alpha}{3} \right)^4$	
14 	-		$K_y = \frac{6.97}{\alpha^2} + \frac{3.1}{\alpha^2} \left[\frac{4 - 1/\alpha}{3} \right]^4$	$C_y = 1$ for $\lambda \leq 0.83$ $C_y = 1.13 \left(\frac{1}{\lambda} - \frac{0.22}{\lambda^2} \right)$ for $\lambda > 0.83$

S11A

(cont)

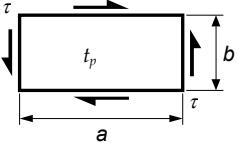
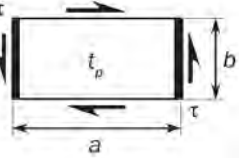
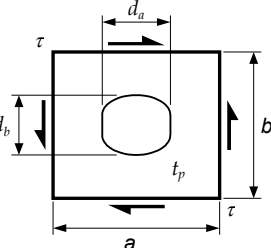
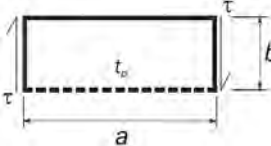
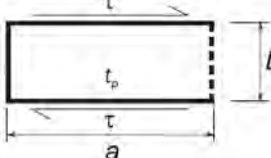
Case	Stress ratio ψ	Aspect ratio α	Buckling factor K	Reduction factor C
<p>15</p> 	-		$K_{\tau} = \sqrt{3} \left[5.34 + \frac{4}{\alpha^2} \right]$	
<p>16</p> 	-		$K_{\tau} = \sqrt{3} \left\{ 5.34 + \text{Max} \left[\frac{4}{\alpha^2}; \frac{7.15}{\alpha^{2.5}} \right] \right\}$	$C_{\tau} = 1 \quad \text{for } \lambda \leq 0.84$ $C_{\tau} = \frac{0.84}{\lambda} \quad \text{for } \lambda > 0.84$
<p>17</p> 	-		<p>$K = K^* r$ $K^* = K$ according to case 15. $r =$ opening reduction factor taken as</p> $r = \left(1 - \frac{d_a}{a} \right) \left(1 - \frac{d_b}{b} \right)$ <p>with $\frac{d_a}{a} \leq 0.7$ and $\frac{d_b}{b} \leq 0.7$</p>	
<p>18</p> 	-		$K_{\tau} = 3^{0.5} (0.6 + 4/\alpha^2)$	$C_{\tau} = 1 \quad \text{for } \lambda \leq 0.84$ $C_{\tau} = \frac{0.84}{\lambda} \quad \text{for } \lambda > 0.84$
<p>19</p> 	-		$K_{\tau} = 8$	
<p>Edge boundary conditions:</p> <p>----- Plate edge free. _____ Plate edge simply supported. _____ Plate edge clamped.</p>				
<p>Notes:</p> <p>1) Cases listed are general cases. Each stress component (σ_x, σ_y) is to be understood in local coordinates.</p>				

2.2 Curved plate panels

This requirement for curved plate limit state is applicable when $R/t_p \leq 2500$. Otherwise, the requirement for plate limit state given in 2.1.1 is applicable.

The curved plate limit state is based on the following interaction formula:

$$\left(\frac{\gamma_c \sigma_{ax}}{C_{ax} R_{eH_P}} \right)^{1.25} + \left(\frac{\gamma_c \tau \sqrt{3}}{C_\tau R_{eH_P}} \right)^2 = 1.0$$

where:

σ_{ax} : Applied axial stress to the cylinder corresponding to the curved plate panel, in N/mm². In case of tensile axial stresses, $\sigma_{ax} = 0$.

C_{ax} , C_τ : Buckling reduction factor of the curved plate panel, as defined in Table 3.

The stress multiplier factor γ_c of the curved plate panel needs not be taken less than the stress multiplier factor γ_c for the expanded plane panel according to 2.1.1.

Table 3: Buckling Factor and reduction factor for curved plate panel with $R/t_p \leq 2500$

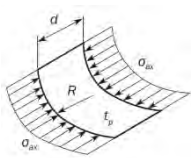
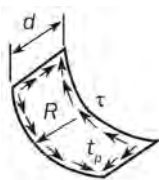
Case	Aspect ratio	Buckling factor K	Reduction factor C
1 	$\frac{d}{R} \leq 0.5 \sqrt{\frac{R}{t_p}}$	$K = 1 + \frac{2}{3} \frac{d^2}{R t_p}$	For general application: $C_{ax} = 1$ for $\lambda \leq 0.25$ $C_{ax} = 1.233 - 0.933\lambda$ for $0.25 < \lambda \leq 1$ $C_{ax} = 0.3/\lambda^3$ for $1 < \lambda \leq 1.5$ $C_{ax} = 0.2/\lambda^2$ for $\lambda > 1.5$ For curved single fields, e.g. bilge strake, which are bounded by plane panels: $C_{ax} = 0.65/\lambda^2 \leq 1.0$
	$\frac{d}{R} > 0.5 \sqrt{\frac{R}{t_p}}$	$K = 0.267 \frac{d^2}{R t_p} \left[3 - \frac{d}{R} \sqrt{\frac{t_p}{R}} \right]$ $\geq 0.4 \frac{d^2}{R t_p}$	
2 	$\frac{d}{R} \leq 8.7 \sqrt{\frac{R}{t_p}}$	$K = \sqrt{3} \sqrt{28.3 + \frac{0.67 d^3}{R^{1.5} t_p^{1.5}}}$	$C_\tau = 1$ for $\lambda \leq 0.4$ $C_\tau = 1.274 - 0.686\lambda$ for $0.4 < \lambda \leq 1.2$ $C_\tau = 0.65/\lambda^2$ for $\lambda > 1.2$
	$\frac{d}{R} > 8.7 \sqrt{\frac{R}{t_p}}$	$K = \sqrt{3} \frac{0.28 d^2}{R \sqrt{R t_p}}$	
Explanations for boundary conditions: ——— Plate edge simply supported.			

3 Buckling capacity of overall stiffened panel

The elastic stiffened panel limit state is based on the following interaction formula:

$$\frac{P_z}{c_f} = 1$$

where P_z and c_f are defined in 4.4.3.

4 Buckling capacity of longitudinal stiffeners

4.1 Stiffeners limit states

The buckling capacity of longitudinal stiffeners is to be checked for the following limit states:

- Stiffener induced failure (*SI*).
- Associated plate induced failure (*PI*).

4.2 Lateral pressure

The lateral pressure is to be considered as constant in the buckling strength assessment of longitudinal stiffeners.

4.3 Stiffener idealization

4.3.1 Effective length of the stiffener ℓ_{eff}

The effective length of the stiffener ℓ_{eff} , in mm, is to be taken equal to:

$$\ell_{eff} = \frac{\ell}{\sqrt{3}} \quad \text{for stiffener fixed at both ends.}$$

$$\ell_{eff} = 0.75\ell \quad \text{for stiffener simply supported at one end and fixed at the other.}$$

$$\ell_{eff} = \ell \quad \text{for stiffener simply supported at both ends.}$$

4.3.2 Effective width of the attached plating b_{eff1}

The effective width of the attached plating of a stiffener b_{eff1} , in mm, without the shear lag effect is to be taken equal to:

$$b_{eff1} = \frac{C_{x1}b_1 + C_{x2}b_2}{2}$$

where:

C_{x1}, C_{x2} : Reduction factor defined in Table 2 calculated for the EPP1 and EPP2 on each side of the considered stiffener according to case 1.

b_1, b_2 : Width of plate panel on each side of the considered stiffener, in mm.

4.3.3 Effective width of attached plating b_{eff}

The effective width of attached plating of stiffeners, b_{eff} , in mm, is to be taken as:

$$b_{eff} = \min(b_{eff1}, \chi_s s)$$

where:

χ_s : Effective width coefficient to be taken as:

- $\chi_s = \min \left[\frac{1.12}{1 + \frac{1.75}{\left(\frac{\ell_{eff}}{s}\right)^{1.6}}}; 1 \right]$ for $\frac{\ell_{eff}}{s} \geq 1$
- $\chi_s = 0.407 \frac{\ell_{eff}}{s}$ for $\frac{\ell_{eff}}{s} < 1$

S11A

(cont)

4.3.4 Net thickness of attached plating t_p

The net thickness of plate t_p , in mm, is to be taken as the mean thickness of the two attached plating panels.

4.3.5 Effective web thickness of flat bar

For accounting the decrease of stiffness due to local lateral deformation, the effective web thickness of flat bar stiffener, in mm, is to be used for the calculation of the net sectional area, A_s , the net section modulus, Z , and the moment of inertia, I , of the stiffener and is taken as:

$$t_{w_red} = t_w \left(1 - \frac{2\pi^2}{3} \left(\frac{h_w}{s} \right)^2 \left(1 - \frac{b_{eff1}}{s} \right) \right)$$

4.3.6 Net section modulus Z of a stiffener

The net section modulus Z of a stiffener, in cm^3 , including effective width of plating b_{eff} is to be taken equal to:

- the section modulus calculated at the top of stiffener flange for stiffener induced failure (S/I).
- the section modulus calculated at the attached plating for plate induced failure (PI).

4.3.7 Net moment of inertia I of a stiffener

The net *moment* of inertia I , in cm^4 , of a stiffener including effective width of attached plating b_{eff} is to comply with the following requirement:

$$I \geq \frac{s t_p^3}{12 \cdot 10^4}$$

4.3.8 Idealisation of bulb profile

Bulb profiles may be considered as equivalent angle profiles. The net dimensions of the equivalent built-up section are to be obtained, in mm, from the following formulae.

$$h_w = h'_w - \frac{h'_w}{9.2} + 2$$

$$b_f = \alpha \left(t'_w + \frac{h'_w}{6.7} - 2 \right)$$

$$t_f = \frac{h'_w}{9.2} - 2$$

$$t_w = t'_w$$

where:

h'_w, t'_w : Net height and thickness of a bulb section, in mm, as shown in Figure 2.

α : Coefficient equal to:

S11A

(cont)

$$\alpha = 1.1 + \frac{(120-h'_w)^2}{3000} \quad \text{for } h'_w \leq 120$$

$$\alpha = 1.0 \quad \text{for } h'_w > 120$$

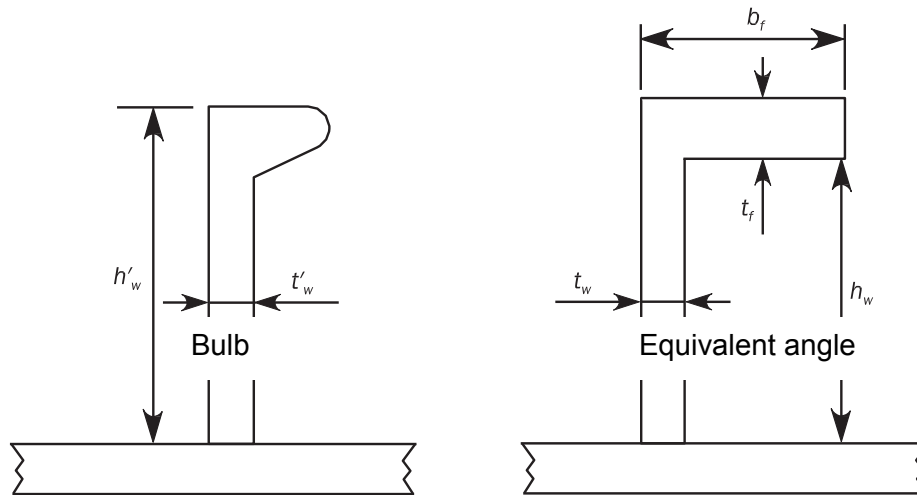

Figure 2: Idealisation of bulb stiffener

4.4 Ultimate buckling capacity

4.4.1 Longitudinal stiffener limit state

When $\sigma_a + \sigma_b + \sigma_w > 0$, the ultimate buckling capacity for stiffeners is to be checked according to the following interaction formula:

$$\frac{\gamma_c \sigma_a + \sigma_b + \sigma_w}{R_{eH}} = 1$$

where:

σ_a : Effective axial stress, in N/mm², at mid-span of the stiffener, defined in 4.4.2.

σ_b : Bending stress in the stiffener, in N/mm², defined in 4.4.3.

σ_w : Stress due to torsional deformation, in N/mm², defined in 4.4.4.

R_{eH} : Specified minimum yield stress of the material, in N/mm²:

- $R_{eH} = R_{eH-S}$ for stiffener induced failure (SI).
- $R_{eH} = R_{eH-P}$ for plate induced failure (PI).

S11A

(cont)

4.4.2 Effective axial stress σ_a

The effective axial stress σ_a , in N/mm², at mid-span of the stiffener, acting on the stiffener with its attached plating is to be taken equal to:

$$\sigma_a = \sigma_x \frac{st_p + A_s}{b_{eff} t_p + A_s}$$

where:

σ_x : Nominal axial stress, in N/mm², acting on the stiffener with its attached plating, calculated according to S11A. 4.4.1 a) at load calculation point of the stiffener.

A_s : Net sectional area, in mm², of the considered stiffener.

4.4.3 Bending stress σ_b

The bending stress in the stiffener σ_b , in N/mm², is to be taken equal to:

$$\sigma_b = \frac{M_0 + M_1}{Z} 10^{-3}$$

where:

M_1 : Bending moment, in Nmm, due to the lateral load P :

$$M_1 = C_i \frac{|P|s\ell^2}{24} 10^{-3} \quad \text{for continuous stiffener}$$

$$M_1 = C_i \frac{|P|s\ell^2}{8} 10^{-3} \quad \text{for sniped stiffener}$$

P : Lateral load, in kN/m², to be taken equal to the static pressure at the load calculation point of the stiffener.

C_i : Pressure coefficient:

$$C_i = C_{SI} \quad \text{for stiffener induced failure (SI).}$$

$$C_i = C_{PI} \quad \text{for plate induced failure (PI).}$$

C_{PI} : Plate induced failure pressure coefficient:

$$C_{PI} = 1 \quad \text{if the lateral pressure is applied on the side opposite to the stiffener.}$$

$$C_{PI} = -1 \quad \text{if the lateral pressure is applied on the same side as the stiffener.}$$

C_{SI} : Stiffener induced failure pressure coefficient:

$$C_{SI} = -1 \quad \text{if the lateral pressure is applied on the side opposite to the stiffener.}$$

$$C_{SI} = 1 \quad \text{if the lateral pressure is applied on the same side as the stiffener.}$$

M_0 : Bending moment, in Nm, due to the lateral deformation w of stiffener:

$$M_0 = F_E \left(\frac{P_z w}{c_f - P_z} \right) \quad \text{with} \quad c_f - P_z > 0.$$

F_E : Ideal elastic buckling force of the stiffener, in N.

$$F_E = \left(\frac{\pi}{\ell} \right)^2 EI 10^4$$

P_z : Nominal lateral load, in N/mm², acting on the stiffener due to stresses σ_x and τ , in the attached plating in way of the stiffener mid span:

S11A

(cont)

$$P_z = \frac{t_p}{s} \left(\sigma_{x\ell} \left(\frac{\pi s}{\ell} \right)^2 + \sqrt{2} \tau_1 \right)$$

$$\sigma_{x\ell} = \gamma_c \sigma_x \left(1 + \frac{A_s}{s t_p} \right) \text{ but not less than } 0$$

$$\tau_1 = \left(\gamma_c |\tau| - t_p \sqrt{R_{eH-p} E \left(\frac{m_1}{a^2} + \frac{m_2}{s^2} \right)} \right) \geq 0 \text{ but not less than } 0$$

m_1, m_2 : Coefficients taken equal to:

- $m_1 = 1.47, m_2 = 0.49$ for $\alpha \geq 2$.
- $m_1 = 1.96, m_2 = 0.37$ for $\alpha < 2$.

w : Deformation of stiffener, in mm, taken equal to:

$$w = w_0 + w_1$$

w_0 : Assumed imperfection, in mm, taken equal to:

- $w = \ell 10^{-3}$ in general
- $w_0 = -w_{na}$ for stiffeners sniped at both ends, considering stiffener induced failure (SI)
- $w_0 = w_{na}$ for stiffeners sniped at both ends, considering plate induced failure (PI)

w_{na} : Distance, in mm, from the mid-point of attached plating to the neutral axis of the stiffener calculated with the effective width of the attached plating b_{eff} .

w_1 : Deformation of stiffener at midpoint of stiffener span due to lateral load P , in mm. In case of uniformly distributed load, w_1 is to be taken as:

- $w_1 = C_i \frac{|P|s \ell^4}{384 EI} 10^{-7}$ in general
- $w_1 = C_i \frac{5 |P|s \ell^4}{384 EI} 10^{-7}$ for stiffener sniped at both ends

c_f : Elastic support provided by the stiffener, in N/mm^2 , to be taken equal to:

$$c_f = F_E \left(\frac{\pi}{\ell} \right)^2 (1 + c_p)$$

c_p : Coefficient to be taken as:

$$c_p = \frac{1}{1 + \frac{0.91}{c_{xa}} \left(\frac{12 I 10^4}{s t_p^3} - 1 \right)}$$

c_{xa} : Coefficient to be taken as:

$$c_{xa} = \left(\frac{\ell}{2s} + \frac{2s}{\ell} \right)^2 \quad \text{for } \ell \geq 2s$$

$$c_{xa} = \left(1 + \left(\frac{\ell}{2s} \right)^2 \right)^2 \quad \text{for } \ell < 2s$$

S11A

(cont)

4.4.4 Stress due to torsional deformation σ_w

The stress due to torsional deformation σ_w , in N/mm^2 , is to be taken equal to:

$$\sigma_w = E y_w \left(\frac{t_f}{2} + h_w \right) \Phi_0 \left(\frac{\pi}{\ell} \right)^2 \left(\frac{1}{1 - \frac{0.4 R_e H - S}{\sigma_{ET}}} - 1 \right) \text{ for stiffener induced failure (SI).}$$

$$\sigma_w = 0 \quad \text{for plate induced failure (PI).}$$

where:

y_w : Distance, in mm, from centroid of stiffener cross-section to the free edge of stiffener flange, to be taken as:

$$y_w = \frac{t_w}{2} \quad \text{for flat bar.}$$

$$y_w = b_f - \frac{h_w t_w^2 + t_f b_f^2}{2A_s} \quad \text{for angle and bulb profiles.}$$

$$y_w = \frac{b_f}{2} \quad \text{for Tee profile.}$$

$$\Phi_0 = \frac{\ell}{h_w} 10^{-3}$$

σ_{ET} : Reference stress for torsional buckling, in N/mm^2 :

$$\sigma_{ET} = \frac{E}{I_P} \left(\frac{\varepsilon \pi^2 I_\omega}{\ell^2} 10^2 + 0.385 I_T \right)$$

I_P : Net polar moment of inertia of the stiffener about point C as shown in Figure 3, as defined in Table 4, in cm^4 .

I_T : Net St. Venant's moment of inertia of the stiffener, as defined in Table 4, in cm^4 .

I_ω : Net sectional moment of inertia of the stiffener about point C as shown in Figure 3, as defined in Table 4, in cm^6 .

ε : Degree of fixation.

$$\varepsilon = 1 + \frac{\left(\frac{\ell}{\pi} \right)^2 10^{-3}}{\sqrt{I_\omega \left(\frac{0.75 S}{t_p^3} + \frac{e_f - 0.5 t_f}{t_w^3} \right)}}$$

Table 4: Moments of inertia

	Flat bars	Bulb, angle and Tee profiles
I_P	$\frac{h_w^3 t_w}{3 \cdot 10^4}$	$\left(\frac{A_w (e_f - 0.5t_f)^2}{3} + A_f e_f^2 \right) 10^{-4}$
I_T	$\frac{h_w t_w^3}{3 \cdot 10^4} \left(1 - 0.63 \frac{t_w}{h_w} \right)$	$\frac{(e_f - 0.5t_f) t_w^3}{3 \cdot 10^4} \left(1 - 0.63 \frac{t_w}{e_f - 0.5t_f} \right)$ + $\frac{b_f t_f^3}{3 \cdot 10^4} \left(1 - 0.63 \frac{t_f}{b_f} \right)$
I_ω	$\frac{h_w^3 t_w^3}{36 \cdot 10^6}$	$\frac{A_f e_f^2 b_f^2}{12 \cdot 10^6} \left(\frac{A_f + 2.6 A_w}{A_f + A_w} \right)$ for bulb and angle profiles. $\frac{b_f^3 t_f e_f^2}{12 \cdot 10^6}$ for Tee profiles.
A_w : Net web area, in mm ² . A_f : Net flange area, in mm ² .		

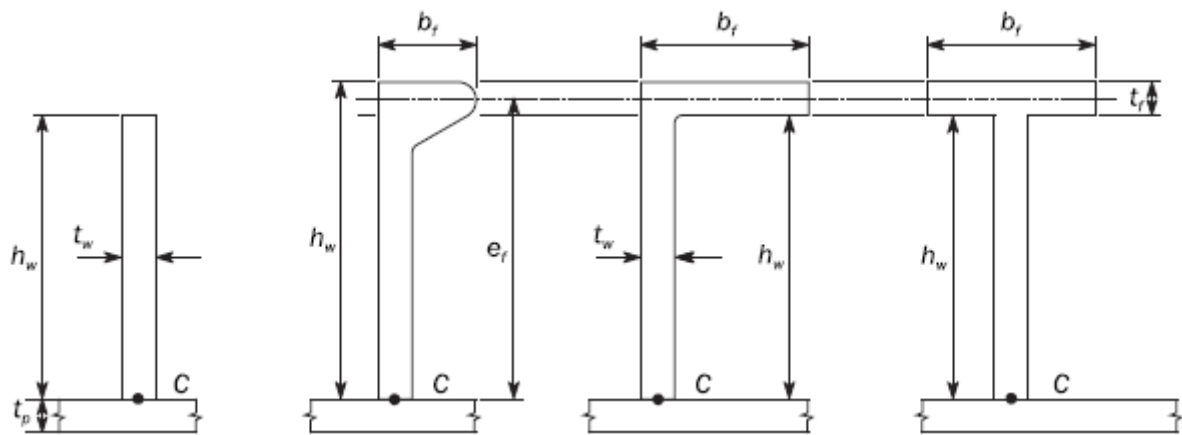

Figure 3: Stiffener cross sections

S11A Annex 3 - Hull girder ultimate bending capacity

(Cont)

Symbols

I_{y-net} :	Net moment of inertia, in m^4 , of the hull transverse section around its horizontal neutral axis
Z_{B-net}, Z_{D-net} :	Section moduli, in m^3 , at bottom and deck, respectively,
R_{eH_S} :	Minimum yield stress, in N/mm^2 , of the material of the considered stiffener.
R_{eH_P} :	Minimum yield stress, in N/mm^2 , of the material of the considered plate.
A_{s-net} :	Net sectional area, in cm^2 , of stiffener, without attached plating.
A_{p-net} :	Net sectional area, in cm^2 , of attached plating.

1. General Assumptions

1.1

The method for calculating the ultimate hull girder capacity is to identify the critical failure modes of all main longitudinal structural elements.

1.2

Structures compressed beyond their buckling limit have reduced load carrying capacity. All relevant failure modes for individual structural elements, such as plate buckling, torsional stiffener buckling, stiffener web buckling, lateral or global stiffener buckling and their interactions, are to be considered in order to identify the weakest inter-frame failure mode.

2. Incremental-iterative method

2.1 Assumptions

In applying the incremental-iterative method, the following assumptions are generally to be made:

- The ultimate strength is calculated at hull transverse sections between two adjacent transverse webs.
- The hull girder transverse section remains plane during each curvature increment.
- The hull material has an elasto-plastic behaviour.
- The hull girder transverse section is divided into a set of elements, see 2.2.2, which are considered to act independently.

According to the iterative procedure, the bending moment M_i acting on the transverse section at each curvature value χ_i is obtained by summing the contribution given by the stress σ acting on each element. The stress σ corresponding to the element strain, ε is to be obtained for each curvature increment from the non-linear load-end shortening curves σ - ε of the element.

These curves are to be calculated, for the failure mechanisms of the element, from the formulae specified in 2.3. The stress σ is selected as the lowest among the values obtained from each of the considered load-end shortening curves σ - ε .

S11A (cont)

The procedure is to be repeated until the value of the imposed curvature reaches the value χ_F in m^{-1} , in hogging and sagging condition, obtained from the following formula:

$$X_F = \pm 0.003 \frac{M_y}{EI_{y-net}}$$

where:

M_y : Lesser of the values M_{Y1} and M_{Y2} , in kNm.

$$M_{Y1} = 10^3 R_{eH} Z_{B-net}.$$

$$M_{Y2} = 10^3 R_{eH} Z_{D-net}.$$

If the value χ_F is not sufficient to evaluate the peaks of the curve $M_{-\chi}$, the procedure is to be repeated until the value of the imposed curvature permits the calculation of the maximum bending moments of the curve.

2.2 Procedure

2.2.1 General

The curve $M_{-\chi}$ is to be obtained by means of an incremental-iterative approach, summarised in the flow chart in Figure 1.

In this procedure, the ultimate hull girder bending moment capacity, M_U is defined as the peak value of the curve with vertical bending moment M versus the curvature χ of the ship cross section as shown in Figure 1. The curve is to be obtained through an incremental-iterative approach.

Each step of the incremental procedure is represented by the calculation of the bending moment M_i which acts on the hull transverse section as the effect of an imposed curvature χ_i .

For each step, the value χ_i is to be obtained by summing an increment of curvature, $\Delta\chi$ to the value relevant to the previous step χ_{i-1} . This increment of curvature corresponds to an increment of the rotation angle of the hull girder transverse section around its horizontal neutral axis.

This rotation increment induces axial strains ε in each hull structural element, whose value depends on the position of the element. In hogging condition, the structural elements above the neutral axis are lengthened, while the elements below the neutral axis are shortened, and vice-versa in sagging condition.

The stress σ induced in each structural element by the strain ε is to be obtained from the load-end shortening curve σ - ε of the element, which takes into account the behaviour of the element in the non-linear elasto-plastic domain.

The distribution of the stresses induced in all the elements composing the hull transverse section determines, for each step, a variation of the neutral axis position due to the nonlinear σ - ε , relationship. The new position of the neutral axis relevant to the step considered is to be obtained by means of an iterative process, imposing the equilibrium among the stresses acting in all the hull elements on the transverse section.

Once the position of the neutral axis is known and the relevant element stress distribution in the section is obtained, the bending moment of the section M_i around the new position of the

S11A (cont)

neutral axis, which corresponds to the curvature χ_i imposed in the step considered, is to be obtained by summing the contribution given by each element stress.

The main steps of the incremental-iterative approach described above are summarised as follows (see also Figure 1):

- a) Step 1: Divide the transverse section of hull into stiffened plate elements.
- b) Step 2: Define stress-strain relationships for all elements as shown in Table 1.
- c) Step 3: Initialise curvature χ_1 and neutral axis for the first incremental step with the value of incremental curvature (i.e. curvature that induces a stress equal to 1% of yield strength in strength deck) as:

$$\chi_1 = \Delta\chi = 0.01 \frac{R_{eH}}{E} \frac{1}{z_D - z_n}$$

where:

z_D : Z coordinate, in m, of strength deck at side.

z_n : Z coordinate, in m, of horizontal neutral axis of the hull transverse section with respect to the reference coordinate system defined in S11A.1.2.3

- d) Step 4: Calculate for each element the corresponding strain, $\varepsilon_i = \chi(z_i - z_n)$ and the corresponding stress σ_i
- e) Step 5: Determine the neutral axis z_{NA_cur} at each incremental step by establishing force equilibrium over the whole transverse section as:

$$\Sigma A_{i-net} \sigma_i = \Sigma A_{j-net} \sigma_j \quad (i\text{-th element is under compression, } j\text{-th element under tension)}$$

- f) Step 6: Calculate the corresponding moment by summing the contributions of all elements as:

$$M_U = \sum \sigma_{U_i} A_{i-net} (z_i - z_{NA_cur})$$

- g) Step 7: Compare the moment in the current incremental step with the moment in the previous incremental step. If the slope in $M-\chi$ relationship is less than a negative fixed value, terminate the process and define the peak value M_U . Otherwise, increase the curvature by the amount of $\Delta\chi$ and go to Step 4.

S11A

(cont)

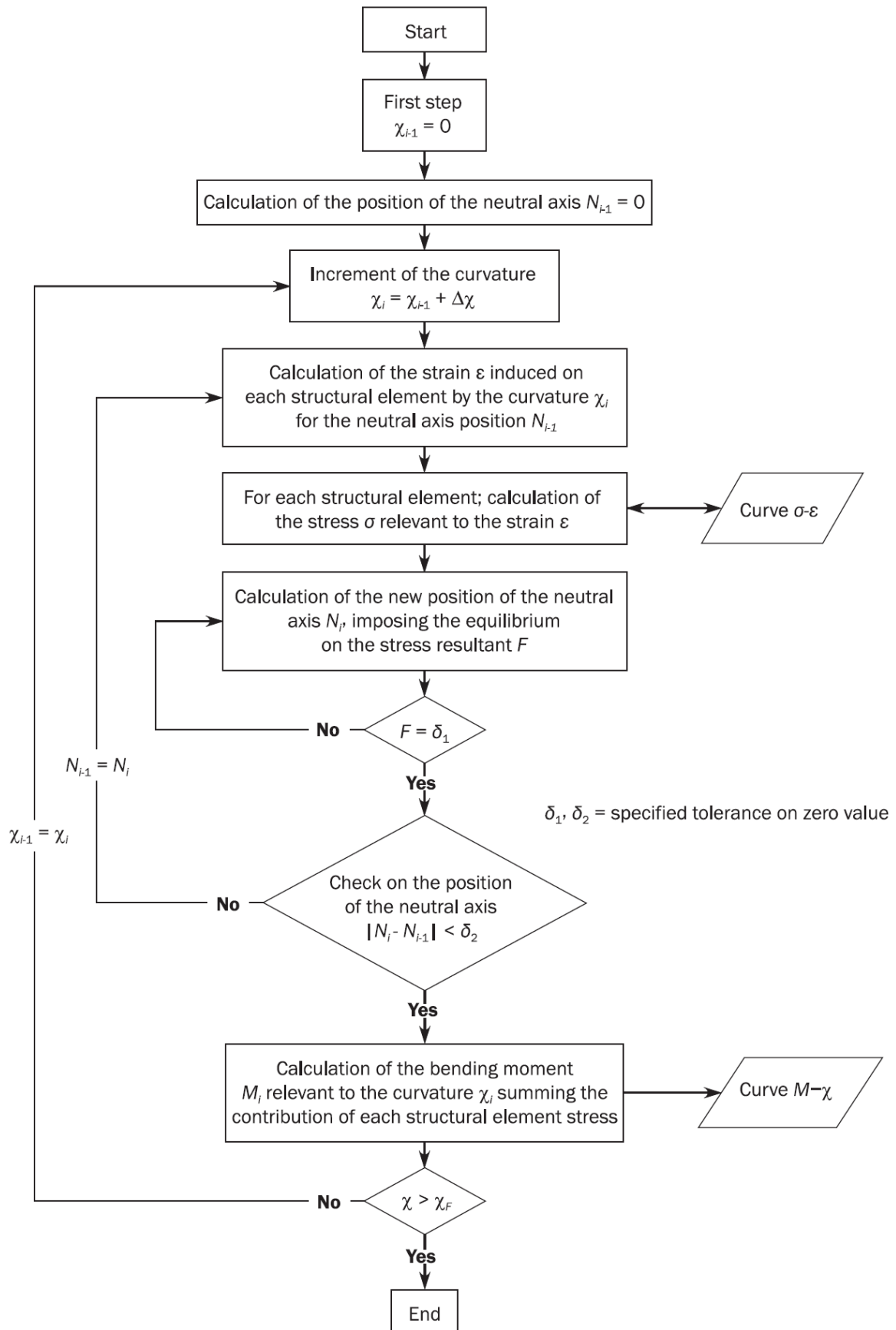

Figure 1: Flow chart of the procedure for the evaluation of the curve $M-\chi$

S11A

(cont)

2.2.2 Modelling of the hull girder cross section

Hull girder transverse sections are to be considered as being constituted by the members contributing to the hull girder ultimate strength.

Sniped stiffeners are also to be modelled, taking account that they do not contribute to the hull girder strength.

The structural members are categorised into a stiffener element, a stiffened plate element or a hard corner element.

The plate panel including web plate of girder or side stringer is idealised into a stiffened plate element, an attached plate of a stiffener element or a hard corner element.

The plate panel is categorised into the following two kinds:

- Longitudinally stiffened panel of which the longer side is in ship's longitudinal direction, and
- Transversely stiffened panel of which the longer side is in the perpendicular direction to ship's longitudinal direction.

a) Hard corner element:

Hard corner elements are sturdier elements composing the hull girder transverse section, which collapse mainly according to an elasto-plastic mode of failure (material yielding); they are generally constituted by two plates not lying in the same plane.

The extent of a hard corner element from the point of intersection of the plates is taken equal to $20 t_{net}$ on a transversely stiffened panel and to $0.5 s$ on a longitudinally stiffened panel, see Figure 2.

where:

t_{net} : Net thickness of the plate, in mm.

s : Spacing of the adjacent longitudinal stiffener, in m.

Bilge, sheer strake-deck stringer elements, girder-deck connections and face plate-web connections on large girders are typical hard corners.

b) Stiffener element:

The stiffener constitutes a stiffener element together with the attached plate.

The attached plate width is in principle:

- Equal to the mean spacing of the stiffener when the panels on both sides of the stiffener are longitudinally stiffened, or
- Equal to the width of the longitudinally stiffened panel when the panel on one side of the stiffener is longitudinally stiffened and the other panel is of the transversely stiffened, see Figure 2.

S11A

(cont)

c) Stiffened plate element:

The plate between stiffener elements, between a stiffener element and a hard corner element or between hard corner elements is to be treated as a stiffened plate element, see Figure 2.

The typical examples of modelling of hull girder section are illustrated in Figure 3. Notwithstanding the foregoing principle, these figures are to be applied to the modelling in the vicinity of upper deck, sheer strake and hatch coaming.

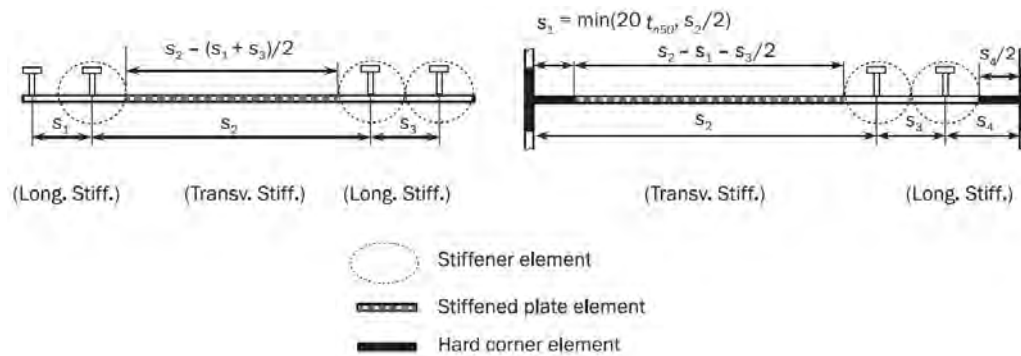

Figure 2: Extension of the breadth of the attached plating and hard corner element

S11A
(cont)

Figure 3: Examples of the configuration of stiffened plate elements, stiffener elements and hard corner elements on a hull section

S11A (cont)

- In case of the knuckle point as shown in Figure 4, the plating area adjacent to knuckles in the plating with an angle greater than 30 degrees is defined as a hard corner. The extent of one side of the corner is taken equal to $20 t_{net}$ on transversely framed panels and to $0.5 s$ on longitudinally framed panels from the knuckle point.
- Where the plate members are stiffened by non-continuous longitudinal stiffeners, the non-continuous stiffeners are considered only as dividing a plate into various elementary plate panels.
- Where the opening is provided in the stiffened plate element, the openings are to be considered in accordance with the requirements of the Classification Society.
- Where attached plating is made of steels having different thicknesses and/or yield stresses, an average thickness and/or average yield stress obtained from the following formula are to be used for the calculation.

$$t_{net} = \frac{t_{1-net}S_1 + t_{2-net}S_2}{S} \quad R_{eH_P} = \frac{R_{eH_P1}t_{1-net}S_1 + R_{eH_P2}t_{2-net}S_2}{t_{net}S}$$

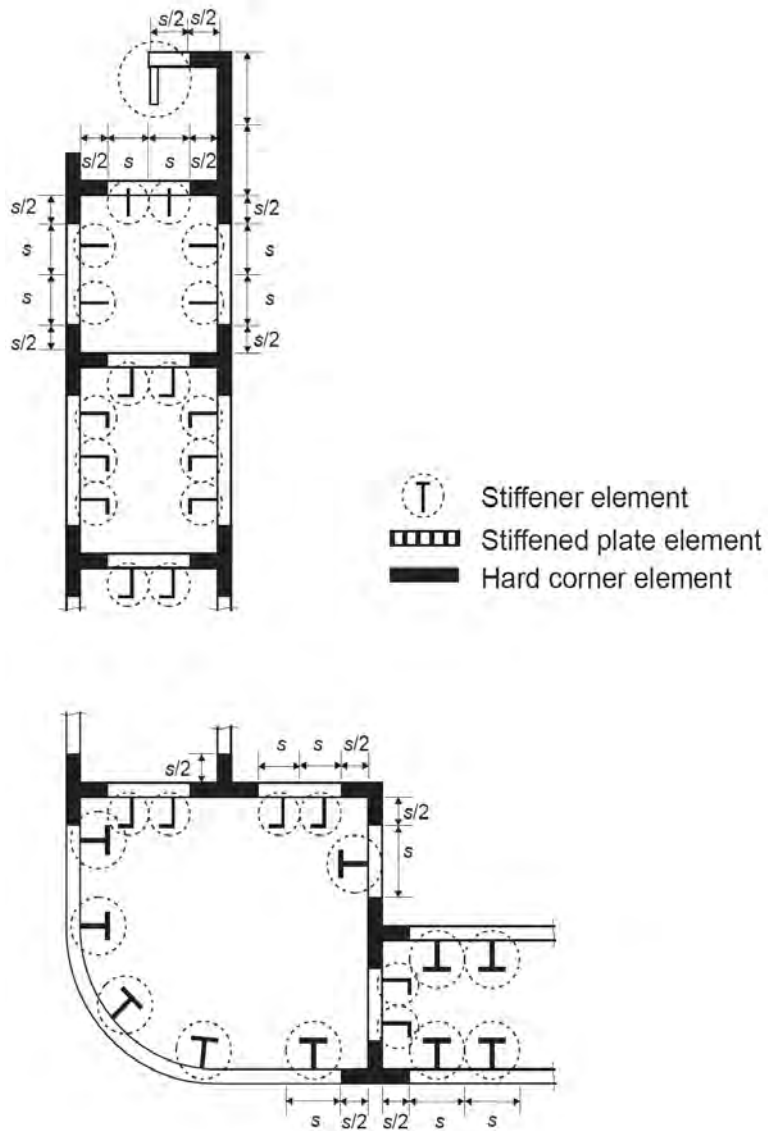
where R_{eH_P1} , R_{eH_P2} , t_{1-net} , t_{2-net} , s_1 , s_2 and s are shown in Figure 5

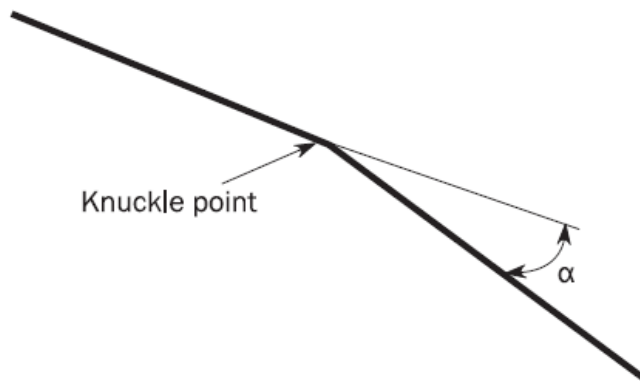

Figure 4: Plating with knuckle point

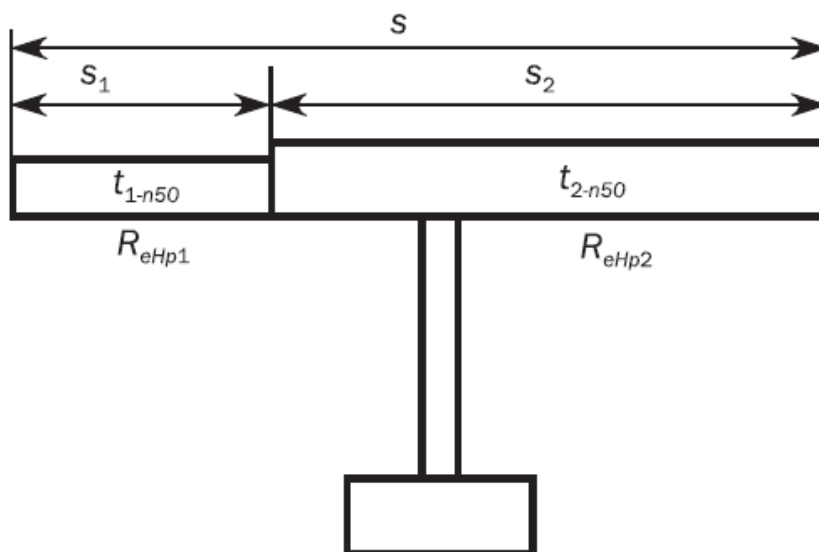

Figure 5: Element with different thickness and yield strength

S11A

(cont)

2.3 Load-end shortening curves

2.3.1 Stiffened plate element and stiffener element

Stiffened plate element and stiffener element composing the hull girder transverse sections may collapse following one of the modes of failure specified in Table 1.

- Where the plate members are stiffened by non-continuous longitudinal stiffeners, the stress of the element is to be obtained in accordance with 2.3.2 to 2.3.7, taking into account the non-continuous longitudinal stiffener.

In calculating the total forces for checking the hull girder ultimate strength, the area of non-continuous longitudinal stiffener is to be assumed as zero.

- Where the opening is provided in the stiffened plate element, the considered area of the stiffened plate element is to be obtained by deducting the opening area from the plating in calculating the total forces for checking the hull girder ultimate strength.
- For stiffened plate element, the effective width of plate for the load shortening portion of the stress-strain curve is to be taken as full plate width, i.e. to the intersection of other plate or longitudinal stiffener – neither from the end of the hard corner element nor from the attached plating of stiffener element, if any. In calculating the total forces for checking the hull girder ultimate strength, the area of the stiffened plate element is to be taken between the hard corner element and the stiffener element or between the hard corner elements, as applicable.

Table 1: Modes of failure of stiffened plate element and stiffener element

Element	Mode of failure	Curve σ - ϵ defined in
Lengthened stiffened plate element or stiffener element	Elasto-plastic collapse	2.3.2
Shortened stiffener element	Beam column buckling Torsional buckling Web local buckling of flanged profiles Web local buckling of flat bars	2.3.3, 2.3.4, 2.3.5, 2.3.6
Shortened stiffened plate element	Plate buckling	2.3.7

2.3.2 Elasto-plastic collapse of structural elements (Hard corner element)

The equation describing the load-end shortening curve σ - ϵ for the elasto-plastic collapse of structural elements composing the hull girder transverse section is to be obtained from the following formula.

$$\sigma = \Phi R_{eHA}$$

where:

R_{eHA} : Equivalent minimum yield stress, in N/mm^2 , of the considered element, obtained by the following formula:

S11A (cont)

$$R_{eHA} = \frac{R_{eH-p} A_{p-net} + R_{eH-s} A_{s-net}}{A_{p-net} + A_{s-net}}$$

Φ : Edge function, equal to:

$$\begin{aligned}\Phi &= -1 \text{ for } \varepsilon < -1 \\ \Phi &= \varepsilon \text{ for } -1 \leq \varepsilon \leq 1 \\ \Phi &= 1 \text{ for } \varepsilon > 1\end{aligned}$$

ε : Relative strain, equal to:

$$\varepsilon = \frac{\varepsilon_E}{\varepsilon_Y}$$

ε_E : Element strain.

ε_Y : Strain at yield stress in the element, equal to:

$$\varepsilon_y = \frac{R_{eHA}}{E}$$

2.3.3 Beam column buckling

The positive strain portion of the average stress – average strain curve $\sigma_{CR1-\varepsilon}$ based on beam column buckling of plate-stiffener combinations is described according to the following:

$$\sigma_{CR1} = \phi \sigma_{C1} \frac{A_{s-net} + A_{pE-net}}{A_{s-net} + A_{p-net}}$$

where:

Φ : Edge function, as defined in 2.3.2.

σ_{C1} : Critical stress, in N/mm², equal to:

$$\sigma_{C1} = \frac{\sigma_{E1}}{\varepsilon} \quad \text{for} \quad \sigma_{E1} \leq \frac{R_{eHB}}{2} \varepsilon$$

$$\sigma_{C1} = R_{eHB} \left(1 - \frac{R_{eHB} \varepsilon}{4 \sigma_{E1}} \right) \quad \text{for} \quad \sigma_{E1} > \frac{R_{eHB}}{2} \varepsilon$$

R_{eHB} : Equivalent minimum yield stress, in N/mm², of the considered element, obtained by the following formula:

$$R_{eHB} = \frac{R_{eH-p} A_{pEI-net} \ell_{pE} + R_{eH-s} A_{s-net} \ell_{sE}}{A_{pEI-net} \ell_{pE} + A_{s-net} \ell_{sE}}$$

$A_{pEI-net}$: Effective area, in cm², equal to:

S11A

(cont)

$$A_{pEI-net} = 10b_{E1}t_{net}$$

l_{pE} : Distance, in mm, measured from the neutral axis of the stiffener with attached plate of width b_{E1} to the bottom of the attached plate

l_{sE} : Distance, in mm, measured from the neutral axis of the stiffener with attached plate of width b_{E1} to the top of the stiffener

ε : Relative strain, as defined in 2.3.2

σ_{E1} : Euler column buckling stress, in N/mm², equal to:

$$\sigma_{E1} = \pi^2 E \frac{I_{E-net}}{A_{E-net} \ell^2} 10^{-4}$$

I_{E-net} : Net moment of inertia of stiffeners, in cm⁴, with attached plate of width b_{E1}

A_{E-net} : Net area, in cm², of stiffeners with attached plating of width b_E

b_{E1} : Effective width corrected for relative strain, in m, of the attached plating, equal to:

$$b_{E1} = \frac{s}{\beta_E} \quad \text{for } \beta_E > 1.0$$

$$b_{E1} = s \quad \text{for } \beta_E \leq 1.0$$

$$\beta_E: \quad \beta_E = 10^3 \frac{s}{t_{net}} \sqrt{\frac{\varepsilon R_{eH-P}}{E}}$$

A_{pE-net} : Net area, in cm², of attached plating of width b_E , equal to:

$$A_{pE-net} = 10b_E t_{net}$$

b_E : Effective width, in m, of the attached plating, equal to:

$$b_E = \left(\frac{2.25}{\beta_E} - \frac{1.25}{\beta_E^2} \right) s \quad \text{for } \beta_E > 1.25$$

$$b_E = s \quad \text{for } \beta_E \leq 1.25$$

2.3.4 Torsional buckling

The load-end shortening curve $\sigma_{CR2-\varepsilon}$ for the flexural-torsional buckling of stiffeners composing the hull girder transverse section is to be obtained according to the following formula:

$$\sigma_{CR2} = \phi \frac{A_{s-net} \sigma_{C2} + A_{p-net} \sigma_{CP}}{A_{s-net} + A_{p-net}}$$

where:

Φ : Edge function, as defined in 2.3.2

S11A

(cont)

σ_{C2} : Critical stress, in N/mm², equal to:

$$\sigma_{C2} = \frac{\sigma_{E2}}{\varepsilon} \quad \text{for } \sigma_{E2} \leq \frac{R_{eH-S}}{2} \varepsilon$$

$$\sigma_{C2} = R_{eH-S} \left(1 - \frac{R_{eH-S} \varepsilon}{4\sigma_{E2}} \right) \quad \text{for } \sigma_{E2} > \frac{R_{eH-S}}{2} \varepsilon$$

ε : Relative strain, as defined in 2.3.2

σ_{E2} : Euler column buckling stress, in N/mm², taken as σ_{ET} defined in Annex 2 4.4.4

σ_{CP} : Buckling stress of the attached plating, in N/mm², equal to:

$$\sigma_{CP} = \left(\frac{2.25}{\beta_E} - \frac{1.25}{\beta_E^2} \right) R_{eH-P} \quad \text{for } \beta_E > 1.25$$

$$\sigma_{CP} = R_{eH-P} \quad \text{for } \beta_E \leq 1.25$$

β_E : Coefficient, as defined in 2.3.3

2.3.5 Web local buckling of stiffeners made of flanged profiles

The load-end shortening curve $\sigma_{CR3-\varepsilon}$ for the web local buckling of flanged stiffeners composing the hull girder transverse section is to be obtained from the following formula:

$$\sigma_{CR3} = \phi \frac{10^3 b_E t_{net} R_{eH-P} + (h_w t_{w-net} + b_f t_{f-net}) R_{eH-S}}{10^3 s t_{net} + h_w t_{w-net} + b_f t_{f-net}}$$

where:

Φ : Edge function, as defined in 2.3.2

b_E : Effective width, in m, of the attached plating, as defined in 2.3.3

h_{we} : Effective height, in mm, of the web, equal to:

$$h_{we} = \left(\frac{2.25}{\beta_w} - \frac{1.25}{\beta_w^2} \right) h_w \quad \text{for } \beta_w \geq 1.25$$

$$h_{we} = h_w \quad \text{for } \beta_w < 1.25$$

β_w :
$$\beta_w = \frac{h_w}{t_{w-net}} \sqrt{\frac{\varepsilon R_{eH-S}}{E}}$$

ε : Relative strain, as defined in 2.3.2

2.3.6 Web local buckling of stiffeners made of flat bars

The load-end shortening curve $\sigma_{CR4-\varepsilon}$ for the web local buckling of flat bar stiffeners composing the hull girder transverse section is to be obtained from the following formula:

S11A (cont)

$$\sigma_{CR4} = \phi \frac{A_{p-net} \sigma_{CP} + A_{s-net} \sigma_{C4}}{A_{p-net} + A_{s-net}}$$

where:

Φ : Edge function, as defined in 2.3.2.

σ_{CP} : Buckling stress of the attached plating, in N/mm², as defined in 2.3.4.

σ_{C4} : Critical stress, in N/mm², equal to:

$$\sigma_{C4} = \frac{\sigma_{E4}}{\varepsilon} \quad \text{for } \sigma_{E4} \leq \frac{R_{eH-S}}{2} \varepsilon$$

$$\sigma_{C4} = R_{eH-S} \left(1 - \frac{R_{eH-S} \varepsilon}{4\sigma_{E4}} \right) \quad \text{for } \sigma_{E4} > \frac{R_{eH-S}}{2} \varepsilon$$

σ_{E4} : Local Euler buckling stress, in N/mm², equal to:

$$\sigma_{E4} = 160000 \left(\frac{t_{w-net}}{h_w} \right)^2$$

ε : Relative strain, as defined in 2.3.2.

2.3.7 Plate buckling

The load-end shortening curve $\sigma_{CR5-\varepsilon}$ for the buckling of transversely stiffened panels composing the hull girder transverse section is to be obtained from the following formula:

$$\sigma_{CR5} = \min \left\{ \Phi R_{eH-P} \left[\frac{s}{\ell} \left(\frac{2.25}{\beta_E} - \frac{1.25}{\beta_E^2} \right) \right]^{R_{eH-P} \Phi} + 0.1 \left(1 - \frac{s}{\ell} \right) \left(1 + \frac{1}{\beta_E^2} \right)^2 \right\}$$

where:

Φ : Edge function, as defined in 2.3.2.

β_E : Coefficient as defined in 2.3.3.

s : Plate breadth, in m, taken as the spacing between the stiffeners.

ℓ : Longer side of the plate, in m.

3. Alternative methods

3.1 General

3.1.1

Application of alternative methods is to be agreed by the Society prior to commencement. Documentation of the analysis methodology and detailed comparison of its results are to be

S11A
(cont)

submitted for review and acceptance. The use of such methods may require the partial safety factors to be recalibrated.

3.1.2

The bending moment-curvature relationship, $M-\chi$, may be established by alternative methods. Such models are to consider all the relevant effects important to the non-linear response with due considerations of:

- a) Non-linear geometrical behaviour.
- b) Inelastic material behaviour.
- c) Geometrical imperfections and residual stresses (geometrical out-of-flatness of plate and stiffeners).
- d) Simultaneously acting loads:
 - Bi-axial compression.
 - Bi-axial tension.
 - Shear and lateral pressure.
- e) Boundary conditions.
- f) Interactions between buckling modes.
- g) Interactions between structural elements such as plates, stiffeners, girders, etc.
- h) Post-buckling capacity.
- i) Overstressed elements on the compression side of hull girder cross section possibly leading to local permanent sets/buckle damages in plating, stiffeners etc. (double bottom effects or similar).

3.2 Non-linear finite element analysis**3.2.1**

Advanced non-linear finite element analyses models may be used for the assessment of the hull girder ultimate capacity. Such models are to consider the relevant effects important to the non-linear responses with due consideration of the items listed in 3.1.2.

3.2.2

Particular attention is to be given to modelling the shape and size of geometrical imperfections. It is to be ensured that the shape and size of geometrical imperfections trigger the most critical failure modes.

End of Document

S34
(May
2015)

Functional Requirements on Load Cases for Strength Assessment of Container Ships by Finite Element Analysis

S34.1 Application

This UR applies to container ships and ships dedicated primarily to carry their cargo in containers.

S34.2 Principles

The requirements in this UR are functional requirements on load cases to be considered on finite element analysis for the structural strength assessment (yielding and buckling).

The procedure for yielding and buckling assessment are to be in accordance with the Rules of the Classification Society. All in-plane stress components (i.e. bi-axial and shear stresses) induced by hull girder loads and local loads as specified in this UR are to be considered.

All aspects and principles not mentioned explicitly in this UR are to be applied according to the procedures of the Classification Society.

S34.3 Definitions

S34.3.1 Global Analysis

A Global Analysis is a finite element analysis, using a full ship model, for assessing the structural strength of global hull girder structure, cross deck structures and hatch corner radii.

S34.3.2 Cargo Hold Analysis

A Cargo Hold Analysis is a finite element analysis for assessing the structural strength of the cargo hold primary structural members (PSM) in the midship region.

Note:

1. This UR is to be uniformly implemented by IACS Societies for ships contracted for construction on or after 1 July 2016.
2. The “contracted for construction” date means the date on which the contract to build the vessel is signed between the prospective owner and the shipbuilder. For further details regarding the date of “contract for construction”, refer to IACS Procedural Requirement (PR) No. 29.

S34
(cont)**S34.3.3 Primary Structural Members (PSM)**

Primary structural members are members of girder or stringer type which provide the overall structural integrity of the hull envelope and cargo hold boundaries, such as:

- (i) double bottom structure (bottom plate, inner bottom plate, girders, floors)
- (ii) double side structure (shell plating, inner hull, stringers and web frames)
- (iii) bulkhead structure
- (iv) deck and cross deck structure

S34.4 Analysis**S34.4.1 Global Analysis**

A Global Analysis is to be carried out for ships of length 290 m or above. Hull girder loads (including torsional effects) are to be considered in accordance with the procedures of the Classification Society. The following methods may be used for Global Analysis:

Method 1: Analysis where hull girder loads only (vertical bending moment, horizontal bending moment and torsional moment) are directly applied to the full ship finite element model

Method 2: Analysis where direct loads transferred from direct load analysis are applied to the full ship finite element model

S34.4.2 Cargo Hold Analysis

Cargo Hold Analysis is to be carried out for ships of length 150 m or above. Local loads such as sea pressure and container loads as well as hull girder loads are to be considered in accordance with the procedures of the Classification Society.

S34.5 Load principles**S34.5.1 Wave environment**

The ship is to be considered sailing in the North Atlantic wave environment for yielding and buckling assessments. The corresponding vertical wave bending moments are to be in line with UR S11A and the other hull girder loads are to be taken in accordance with the Rules of the Classification Society. The corresponding local loads are to be taken in accordance with the Rules of the Classification Society.

S34.5.2 Ship operating conditions

Seagoing conditions are to be considered. Harbour conditions and special conditions such as flooded conditions, tank testing conditions may be considered in accordance with the Rules of the Classification Society.

S34.6 Load components**S34.6.1 Global Analysis**

The load components to be considered in Global Analysis are shown in Table 1.

S34 (cont)

Table 1: Load components to be considered in Global Analysis

	Static load	Dynamic load
Method 1	<ul style="list-style-type: none"> ✓ Still water vertical bending moment ✓ Still water torsional moment 	<ul style="list-style-type: none"> ✓ Wave-induced vertical bending moment ✓ Wave-induced horizontal bending moment ✓ Wave-induced torsional moment
Method 2	<ul style="list-style-type: none"> ✓ Static sea pressure ✓ Static container loads ✓ Static loads for ballast and fuel oil ✓ Self-weight of hull structure 	<ul style="list-style-type: none"> ✓ Wave-induced sea pressure ✓ Dynamic loads for hull structure, containers, ballast and fuel oil

S34.6.2 Cargo Hold Analysis

The load components to be considered in Cargo Hold Analysis are defined in Table 2.

Table 2: Load components to be considered in Cargo Hold Analysis

	Static load	Dynamic load
Hull girder loads	<ul style="list-style-type: none"> ✓ Still water vertical bending moment 	<ul style="list-style-type: none"> ✓ Wave-induced vertical bending moment
Local loads	<ul style="list-style-type: none"> ✓ Static sea pressure ✓ Static container loads ✓ Static loads for ballast and fuel oil⁽¹⁾ ✓ Self-weight of hull structure 	<ul style="list-style-type: none"> ✓ Wave-induced sea pressure ✓ Dynamic loads for hull structure, containers, ballast and fuel oil⁽¹⁾
<p>(1) For the minimum set of loading conditions specified in Table 3, all ballast and fuel oil tanks in way of the cargo hold model are to be empty. If additional loading conditions other than those given in Table 3 are considered, ballast and fuel oil loads may be taken into consideration at the discretion of the Classification Society.</p>		

S34.7 Loading conditions

S34.7.1 Global Analysis

Loading conditions to be considered for the Global Analysis are to be in accordance with the Loading Manual and with the Rules of the Classification Society.

S34.7.2 Cargo Hold Analysis

The minimum set of loading conditions is specified in Table 3. In addition, loading conditions from the Loading Manual are to be considered in the Cargo Hold Analysis where deemed necessary.

S34

(cont)

Table 3: Minimum set of loading conditions for Cargo Hold Analysis

Loading condition	Draught	Container weight	Ballast and fuel oil tanks	Still water hull girder moment
Full load condition	Scantling draught	Heavy cargo weight ⁽¹⁾ (40' containers)	Empty	Permissible hogging
Full load condition	Scantling draught	Light cargo weight ⁽²⁾ (40' containers)	Empty	Permissible hogging
Full load condition	Reduced draught ⁽³⁾	Heavy cargo weight ⁽¹⁾ (20' containers)	Empty	Permissible sagging (minimum hogging)
One bay empty condition ⁽⁴⁾	Scantling draught	Heavy cargo weight ⁽¹⁾ (40' containers)	Empty	Permissible hogging

(1) Heavy cargo weight of a container unit is to be calculated as the permissible stacking weight divided by the maximum number of tiers planned.

(2) Light cargo weight corresponds to the expected cargo weight when light cargo is loaded in the considered holds.

- Light cargo weight of a container unit in hold is not to be taken more than 55% of its related heavy cargo weight (see (1) above).
- Light cargo weight of a container unit on deck is not to be taken more than 90% of its related heavy cargo weight (see (1) above) or 17 metric tons, whichever is the lesser.

(3) Reduced draught corresponds to the expected draught amidships when heavy cargo is loaded in the considered holds while lighter cargo is loaded in other holds. Reduced draught is not to be taken more than 90% of scantling draught.

(4) For one bay empty condition, if the cargo hold consists of two or more bays, then each bay is to be considered entirely empty in hold and on deck (other bays full) in turn as separate load cases.

S34.8 Wave conditions

S34.8.1 Global Analysis

Wave conditions presumed to lead to the most severe load combinations due to vertical bending moment, horizontal bending moment and torsional moment are to be considered.

S34.8.2 Cargo Hold Analysis

The following wave conditions are to be considered:

- Head sea condition yielding the maximum hogging and sagging vertical bending moments.
- Beam sea condition yielding the maximum roll motion. This condition may be disregarded for some loading conditions defined in Table 3 where deemed not necessary.

End of Document
