

LOAD LINE RULES

FOR SEA-GOING SHIPS

ND No. 2-020101-180-E



St. Petersburg

LOAD LINE RULES FOR SEA-GOING SHIPS

The present version of Load Line Rules for Sea-Going Ships of Russian Maritime Register of Shipping (RS, the Register) has been approved in accordance with the established approval procedure and comes into force on 1 January 2026.

The present version is based on the version dated 1 July 2025 and Rule Change Notice No. 25-262653 taking into account the amendments and additions developed immediately before publication (refer to the [Revision History](#)).

REVISION HISTORY¹

Item	Description	Remarks
Para 1.3.1	Description of areas of navigation has been amended	Editorial amendment of 19.02.2026
Table 3.2.5.2.1.1	References to applicable Paras have been corrected	Editorial amendment of 19.02.2026
Table 3.3.2	References to applicable Paras have been corrected	Editorial amendment of 19.02.2026
Para 4.1.3.7	Reference to applicable Para has been amended	Editorial amendment of 19.02.2026

¹ With the exception of amendments and additions introduced by Rule Change Notices (RCN), as well as of misprints and omissions.

1 GENERAL

1.1 SCOPE OF APPLICATION

1.1.1 Application.

1.1.1.1 The requirements of Load Line Rules for Sea-Going Ships¹ cover the following decked ships subject to the Register technical supervision:

.1 ships of 24 m in length and more not engaged in international voyages or engaged in international voyages exclusively in the Caspian Sea, fishing vessels engaged or not engaged in international voyages with the exception of yachts;

.2 all types of new mobile offshore drilling units (MODU) granted with the Load Line Certificate according to [1.4.5.1](#);

.3 ships of less than 24 m in length with the exception of yachts and small craft.

1.1.1.2 Zones, areas and seasonal periods specified in these Rules shall be determined in accordance with the [Annex](#). A port standing on the boundary line between two zones or areas shall be considered as within the zone or area from or into which the ship arrives or departs.

1.1.1.3 Requirements of [Section 3](#) shall apply to every ship to which a minimum freeboard is assigned. Dilution of these requirements may be granted to ships, to which a greater than minimum freeboard is assigned on condition of satisfactory review results of the substantiation provided by the designer, including assessment of stability, unsinkability, seaworthiness, deck flooding and strength analysis.

Where the ship is assigned an excessive freeboard such that the resulting draught is not more than that corresponding to a minimum summer freeboard for the same ship, but with an assumed freeboard deck located at distance below the actual freeboard deck at least equal to the standard superstructure height, the requirements of [3.2.2](#) through [3.2.9](#), [3.2.12](#), [3.2.13](#) and [3.3](#) being applied, the actual freeboard deck may be considered as a superstructure deck.

1.1.1.4 The freeboard for ships, specified in [1.1.1.1.1](#) shall be assigned in accordance with [Section 4](#).

Freeboard of MODUs specified in [1.1.1.1.2](#) shall be assigned in accordance with [Section 6](#).

Freeboard of ships of less than 24 m in length specified in [1.1.1.1.3](#) shall be assigned in accordance with [Section 7](#).

Freeboard of ships carrying timber deck cargoes may be assigned in accordance with [Section 5](#).

1.1.1.5 Ships of wood or composite construction, or of other materials the use of which the Register has approved, or ships whose constructional features are such as to render the application of the requirements of these Rules unreasonable or impracticable, shall be assigned freeboards on the basis of the substantiation provided by the designer, including assessment of stability, unsinkability, seaworthiness, deck flooding and strength analysis.

1.1.1.6 Cargo ships of unrestricted service specified in [1.1.1.1.1](#) may be additionally assigned freeboards to operate within the restricted area of navigation **R1**. Cargo ships of restricted area of navigation specified in [1.1.1.1.1](#), as well as hopper dredgers and hopper barges irrespective of the area of their navigation without soil in hoppers may be additionally assigned the freeboard to operate within the restricted area of navigation **R3**.

1.1.1.7 Cargo ships specified in [1.1.1.1.1](#) may be additionally assigned freeboards to operate within the restricted area of navigation **RN(SCI)** and/or **RN(SCII)**.

¹ Hereinafter referred to as "these Rules".

1.1.1.8 For ships of the restricted area of navigation **R0**, the freeboard is assigned as for ships of the unrestricted area of navigation.

1.2 DEFINITIONS AND EXPLANATIONS

1.2.1 The definitions and explanations concerning general terminology of the Rules are given in Part I "Classification" of the Rules for the Classification and Construction of Sea-Going Ships¹.

For the purpose of these Rules, the following definitions have been adopted.

A **forecastle** is a superstructure which extends from ship's bow or, as a minimum, from forward perpendicular aft to a point which is forward of the after perpendicular.

Watertight means capable of preventing the passage of water through the structure in either direction with a proper margin of resistance under the pressure due to the maximum head of water which it might have to sustain.

A **raised quarter deck** is a superstructure which extends, as a minimum, forward from the after perpendicular, generally has a height less than a normal superstructure, and has an intact front bulkhead (sidescuttles of the non-opening type fitted with efficient deadlights and bolted man hole covers). Where the forward bulkhead is not intact due to doors and access openings, the superstructure then shall be considered as a poop.

Height of superstructure is the least vertical height measured at side from the top of the superstructure deck beams to the top of the freeboard deck beams.

A **flush deck ship** is a ship which has no superstructure on the freeboard deck.

Length of superstructure S is the mean length of that part of the superstructure which lies within the length of the ship L .

Length of ship L is taken as 96 % of the total length on a waterline at 85 % of the least moulded depth, or as the length from the fore side of the stem to the axis of the rudder stock on that waterline, if that be greater.

Where the stem contour is concave above the waterline, the length of the ship shall be measured from the vertical projection to that waterline of the aftermost point of the stem contour (above that waterline) (refer to [Fig. 1.2.1-1](#)).

A ship which is composed of a series of successively and permanently attached rigid sections shall have a length determined by the overall length of the series. A propulsion section shall be included in the total length if it is rigidly attached, otherwise it shall be treated as a separate ship.

In ships designed with a rake of keel, the least moulded depth is measured vertically at the point where the freeboard deck sheer curve line is tangential to a straight line drawn parallel to the keel line. The waterline on which the length of the ship is measured shall be parallel to the designed waterline.

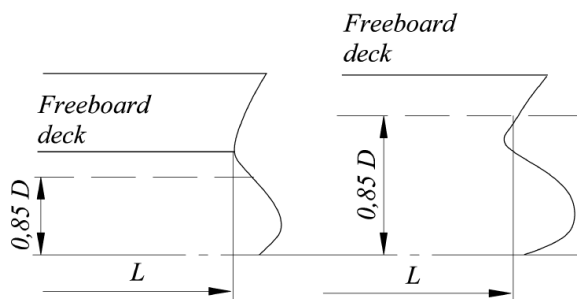

Fig. 1.2.1-1

Anniversary date means the day and the month of each year, which corresponds to the date of expiry of the relevant Certificate.

¹ Hereinafter referred to as the RS Rules/C.

An enclosed superstructure is a superstructure with enclosing bulkheads of adequate strength; access openings, if any, in these bulkheads fitted with doors complying with the requirements of 3.2.2; all other openings in sides or ends bulkheads of the superstructures fitted with efficient weathertight means of closing.

A decked enclosed ship is a ship having over the entire length a deck, openings on the open portions of which have permanent weathertight means of closing and below which openings in sides are fitted with permanent means of watertight closing.

A well is any area on the deck exposed to the weather, where water may be entrapped.

Block coefficient C_b is a coefficient determined by the formula

$$C_b = \frac{\nabla}{LBd_1},$$

where ∇ = the volume of the moulded displacement of the ship, excluding bossing, in a ship with a metal shell, and is the volume of displacement to the outer surface of the hull, excluding bossing, in a ship with a shell of any other material, both taken at a moulded draught of d_1 , m³;

d_1 = 85 % of the least moulded depth, m.

Note. Conventional nature of L definition can result in C_b values exceeding 1, e.g. for the pontoon type ships. In this case $C_b=1$ is assumed.

In calculations of C_b for multi-hull ships the breadth of the whole ship but not of one hull shall be taken into account.

International voyage is a sea voyage from a country to which the International Convention on Load Lines¹, applies to a port outside such country, or conversely.

Amidships is the transverse section at the middle of ship's length L .

Freeboard is the distance measured vertically downwards amidships from the upper edge of the deck line to the upper edge of the related load line.

Superstructure is a decked structure on the freeboard deck, extending from side to side of the ship or with the side plating not being inboard of the shell plating more than 4 % of the breadth B .

A raised quarter deck is regarded as a superstructure.

A bridge or poop shall not be regarded as enclosed unless access is provided for the crew to reach machinery or other working spaces inside superstructures from any point of the uppermost exposed deck or higher than that by alternative means which are available at all times when bulkhead openings are closed.

Weathertight is the term which applies to structures in the above water part of a ship and means that in any sea conditions water shall not penetrate into the ship.

Ship's ends are portions of the ship's length equal to 0,05 L from the forward and after perpendiculars.

Freeboard deck is the deck from which the freeboard is calculated. Normally, it is the uppermost complete deck exposed to weather and sea, which has permanent means of closing all openings in the weather part thereof, and below which all openings in the sides of the ship are fitted with permanent means of watertight closing.

¹ Hereinafter referred to as "the LL-66/88".

In a ship having a freeboard deck with a step of over 1 m in length, which extends over the full breadth of the ship, the lowest line of the exposed deck and the continuation of that line parallel to the upper part of the deck is taken as the freeboard deck, as shown in [Fig. 1.2.1-2](#).

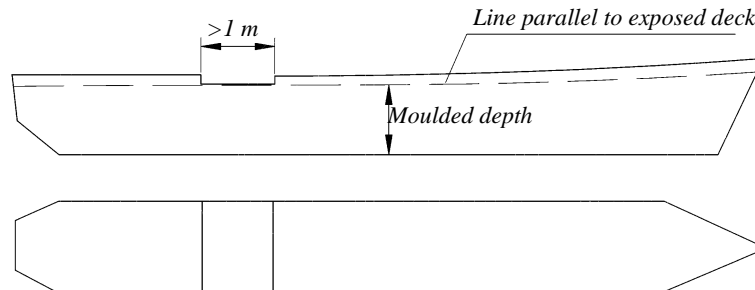

Fig. 1.2.1-2

At the option of the owner and subject to the approval of the Register, a lower deck may be designated as the freeboard deck provided it is a complete and permanent deck continuous in a fore and aft direction at least between the engine room and peak bulkheads and also continuous athwartships.

Such freeboard deck as a minimum shall consist of suitably framed stringers at the ship sides longitudinally and transversely at each watertight bulkhead which extends to the upper deck, within cargo spaces.

The width of these stringers shall not be less than can be conveniently fitted having regard to the structure and the operation of the ship.

When this lower deck is stepped more than 1 m in length and the discontinuity extends over the full ship breadth, the lowest line of the deck and the continuation of that line parallel to the upper part of the deck outside the step is taken as the freeboard deck. When a lower deck is designated as the freeboard deck, that part of the hull which extends above the freeboard deck is treated as a superstructure so far as concerns the application of the conditions of assignment and the calculation of freeboard.

The following deck may be taken for the freeboard deck on lash lighter carriers and similar docklift ships:

the uppermost continuous deck, provided that all openings are fitted with watertight closures complying with requirements of these Rules and the aft cargo port is fitted with a watertight closure;

cargo deck, provided that the cargo space has no relevant closures from top or from aft, meanwhile the watertight structure above cargo deck may be treated considering provisions of [4.2.2.3](#) as a superstructure with the niche in the aft bulkhead in the form of a cargo space;

continuous deck, which doesn't assure waterproof closing of cargo hold from the sea impact, provided that a cargo hold is fitted with watertight closure from the aft up to the level of this deck as well as:

the deck is continuous and uninterrupted in the longitudinal and transverse sections at least beyond the area limited by longitudinal and transverse bulkheads of cargo hold;

the freeboard height is calculated considering adjustment for recess in accordance with provisions of [4.4.9.1 – 4.4.9.3](#) of these Rules;

sufficient safety level is confirmed by model tests and calculations considering possible ingress of water into cargo space as a result of atmospheric precipitation and splashing and relevant means of drainage are provided.

Superstructure deck is a deck forming the upper boundary of a superstructure.

Timber deck cargo is a cargo of timber carried on an uncovered part of a freeboard or superstructure deck. The term does not include wood pulp or similar cargo.

Sailing ship is a ship which has a sail area sufficient for her movement independently of the provision of mechanical means of propulsion.

Perpendiculars are the forward and after perpendiculars which shall be taken at the forward and after ends of the length L . The forward perpendicular shall coincide with the foreside of the stem on the waterline on which the length is measured.

Depth for freeboard D is the moulded depth amidships, plus the freeboard deck thickness at side.

The depth for freeboard in a ship having a rounded gunwale with a radius greater than 4 % of the breadth B or having topsides of unusual form is the depth for freeboard of a ship having a midship section with vertical topsides and with the same round of beam and area of topside section equal to that provided by the actual midship section (refer to [Fig. 1.2.1-3](#)).

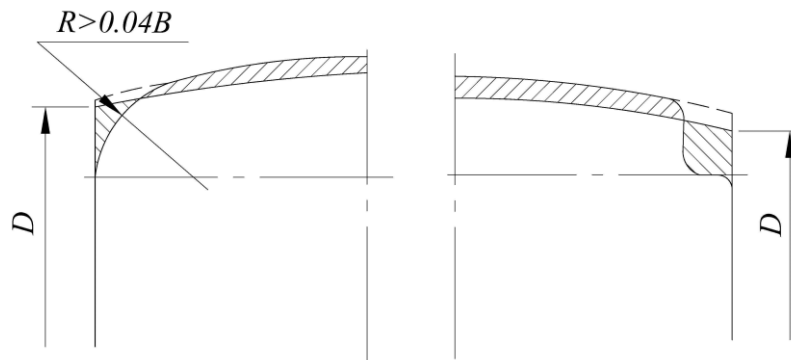

Fig. 1.2.1-3

Deckhouse is a decked structure on the freeboard or superstructure deck which is set in from the any sides of the ship for more than 4 % of the breadth B and has doors, windows or other similar openings in the outer bulkheads.

Full superstructure is a superstructure which, as a minimum, extends from the forward to the after perpendicular.

Bridge is a superstructure located between aft and forward perpendiculars not reaching either of them.

Ship of river-sea navigation is a self-propelled cargo ship intended for carriage of cargoes by sea and inland waterways without transshipping.

Moulded depth is the vertical distance measured from the top of the keel to the top of the freeboard deck beam at side. In wooden and composite ships this distance is measured from the lower edge of the keel rabbet. Where the form at the lower part of the midship section is of a hollow character or where thick garboards are fitted, the moulded depth is measured from the point where the line of the flat of the bottom continued inwards cuts the side of the keel.

In ships having rounded gunwales, the moulded depth shall be measured to the point of intersection of the moulded lines of deck and sides, the lines extending as though the gunwale were of angular design.

Where a step of over 1 m in length exists in the freeboard deck creating a discontinuity over the full breadth of the ship and the raised part of the deck extends over the point at which the moulded depth shall be determined, the moulded depth shall be measured to a line of reference extending from the lower part of the deck along a line parallel with the raised part. A step of 1 m or less in length shall be treated as a recess according to [4.4.9](#).

B r e a d t h o f s h i p *B* is the maximum breadth of the ship, measured amidships to the moulded line of the frame in a ship with a metal shell and to the outer surface of the hull in a ship with a shell of any other material.

P o o p is a superstructure which extends from the stern or, as a minimum, from the after perpendicular forward to a point aft of the forward perpendicular.

T r u n k is a decked structure on the freeboard deck set in from the any sides of the ship for more than 4 % of the breadth *B* and having no doors, windows or other similar openings in the outer bulkheads.

1.3 AREAS OF NAVIGATION

1.3.1 Requirements of these Rules apply to ships of unrestricted and restricted areas of navigation.

Definitions of restricted areas of navigation are given in 2.2.5 of Part I "Classification" of the RS Rules/C.

1.4 SCOPE OF SURVEY AND CERTIFICATES

1.4.1 Technical documentation.

The documents to be submitted to the Register for assigning the freeboard under provisions of these Rules are as follows:

- .1 lines drawing;
- .2 general arrangement plans;
- .3 determination of scantlings of hull members;
- .4 information on stability for master;
- .5 calculation on draught, trim and stability of the ship with the compartments flooded (where the requirements of [4.1.2.2](#), [4.1.3.3](#) — [4.1.3.5](#) shall be complied with);
- .6 information on loading and ballasting (if required in accordance with [3.1.3](#));
- .7 arrangement plan of openings in the hull, super-structures and deckhouses with the specification of the types of closures thereof and the heights of coamings;
- .8 calculation of strength of hatch covers;
- .9 timber deck cargo stowage and securing plans;
- .10 data on the bulwark, guard rails, gangways and walkways, freeing ports and systems (sewage, scupper, ventilation, air pipes, etc.) which shall be in conformity with the requirements of these Rules;
- .11 freeboard calculation and drawings of the load line mark.

1.4.2 Survey and marking of load lines.

Survey and marking of load lines according to the requirements of these Rules is performed by the Register on ships flying the flag of the Russian Federation, as well as on ships having the class of the Register and flying a foreign flag where a respective authorization is issued to the Register by the Flag State Administration.

1.4.3 Initial, renewal and annual surveys.

A ship shall be subjected to the surveys specified below:

- .1 initial survey carried out in the course of technical supervision during construction of the ship, or initial survey of the ship built without technical supervision by the Register or a body authorized by it for substitution.

The survey includes a complete inspection of ship's structure and equipment in so far as the ship is covered by these Rules. This survey shall be such as to ensure that the arrangements, material, and strength of the ship fully comply with the requirements of these Rules.

Record of Conditions of Assignment of Load Lines, freeboard calculation in accordance with the Register Rules and Load Line Certificates specified in [1.4.5](#) are drawn up on the basis of the survey results;

- .2 a renewal survey at intervals not exceed five years, except where [1.4.7.2](#) and [1.4.7.5](#) — [1.4.7.7](#) are applicable, which shall be such as to ensure that the structure and equipment as to their arrangement, design, materials and strength fully comply with the requirements of these Rules.

Ship Survey Statement (Form 6.1.03) and check-list using STORM system or, if applicable, Survey Report are drawn up on the basis of the survey results;

- .3 an annual survey within three months before or after each anniversary date of the Certificate, to ensure that alterations have not been made to the hull or superstructures which shall affect the calculations determining the freeboard and position of the load lines and so as to ensure the maintenance in an effective condition of fittings and appliances for protection of openings, bulwark, guard rails, freeing ports and means of access to crew's and passengers' quarters, the correct indication of freeboard marks and availability on board of the information required by [3.1](#).

The annual survey shall be endorsed on the Load Line Certificate.

1.4.4 Maintenance of conditions after survey.

After any survey of the ship under [1.4.3](#) has been completed, no change shall be made in the structure, equipment, arrangements, materials or scantlings covered by the survey, without the sanction of the Register.

1.4.5 Issue of Certificates.

1.4.5.1 The Load Line Certificate shall be issued to ships which have been surveyed and marked in accordance with [1.1.1.1.1](#), [1.1.1.1.2](#) and [1.1.1.1.3](#) of these Rules.

1.4.6 Forms of Certificates.

The arrangement of the printed part of each model Certificate approved by the Register shall be exactly reproduced in any Certificate issued, and in any certified copies thereof.

1.4.7 Duration and validity of Certificates.

1.4.7.1 A Load Line Certificate shall be issued for a period which shall not exceed 5 years.

1.4.7.2 When determining the period of validity of a Load Line Certificate, consideration shall be given to the following:

.1 notwithstanding the requirements of [1.4.7.1](#), when the renewal survey is completed within 3 months before the expiry date of the existing Certificate, the new Certificate shall be valid from the date of completion of the renewal survey to a date not exceeding 5 years from the date of expiry of the existing Certificate;

.2 when the renewal survey is completed after the expiry date of the existing Certificate, the new Certificate shall be valid from the date of completion of the renewal survey to a date not exceeding 5 years from the date of expiry of the existing Certificate;

.3 when the renewal survey is completed more than 3 months before the expiry date of the existing Certificate, the new Certificate shall be valid from the date of completion of the renewal survey to a date not exceeding 5 years from the date of completion of the renewal survey.

1.4.7.3 If a Certificate is issued for a period of less than 5 years, the Register may extend the validity of a Certificate beyond the expiry date to the maximum period (5 years), provided that the annual surveys, referred to in [1.4.3](#), applicable when a Certificate is issued for a period of 5 years, are carried out as appropriate.

1.4.7.4 If, after the renewal survey referred to in [1.4.3.2](#), a new Certificate cannot be issued to the ship before the expiry date of the existing Certificate, the person or organization carrying out the survey may extend the validity of the existing Certificate for a period which shall not exceed 5 months. This extension shall be endorsed on the Certificate, and shall be granted only where there have been no alterations in the structure, equipment, arrangements, materials or scantlings which affect the ship's freeboard.

1.4.7.5 If a ship at the time when a Certificate expires is not in a port, in which it shall be surveyed, the Register may extend the period of validity of the Certificate, but this extension shall be granted only for the purpose of allowing the ship to complete its voyage to the port, in which it shall be surveyed, and only in cases where it appears proper and reasonable to do so. No Certificate shall be extended for a period more than 3 months, and a ship to which an extension is granted shall not, on its arrival in the port in which it shall be surveyed, be entitled by virtue of such extension to leave that port without having a new Certificate. When the renewal survey is completed, the new Certificate shall be valid to a date not exceeding 5 years from the date of expiry of the existing Certificate before the extension was granted.

1.4.7.6 A Certificate issued to a ship engaged in short voyages, which has not been extended under the foregoing provisions of the above paragraph, may be extended by the Register for a period of grace of up to one month from the date of expiry stated on it. When the renewal survey is completed, the new Certificate shall be valid to a date not exceeding 5 years from the date of expiry of the existing Certificate before the extension was granted.

1.4.7.7 In special circumstances, as determined by the Register, a new Certificate need not be dated from the date of expiry of the existing Certificate as required by [1.4.7.2](#), [1.4.7.5](#)

and [1.4.7.6](#). In these special circumstances, the new Certificate shall be valid to a date not exceeding 5 years from the date of completion of the renewal survey.

1.4.7.8 If an annual survey is completed before the period specified in [1.4.3.3](#) then:

.1 the anniversary date shown in the Certificate shall be amended by endorsement to a date which shall not be more than 3 months later than the date on which the survey was completed;

.2 the subsequent annual survey shall be completed at the intervals prescribed by [1.4.3.3](#) using the new anniversary date;

.3 the expiry date may remain unchanged, provided one or more annual surveys are carried out so that the maximum intervals between the surveys prescribed by [1.4.3](#) are not exceeded.

1.4.7.9 A Load Line Certificate shall cease to be valid if any of the following circumstances exist:

.1 material alterations have taken place in the hull or superstructures of the ship such as shall necessitate the assignment of an increased freeboard;

.2 the fittings and appliances mentioned in [1.4.3.3](#) are not maintained in an effective condition;

.3 the Certificate is not endorsed to show that the ship has been surveyed as provided in [1.4.3.3](#);

.4 the structural strength of the ship is lowered to such an extent that the ship is unsafe.

1.5 GENERAL TECHNICAL REQUIREMENTS

1.5.1 General.

1.5.1.1 For the purpose of establishing uniform principles and requirements with respect to the limits to which ships may be loaded, these Rules set forth minimum freeboards assigned to ships for navigation in certain areas and during certain seasons of the year.

1.5.2 Submersion.

1.5.2.1 The freeboard assigned to a ship shall be indicated on each side of the ship with a deck line, a load line mark and load lines corresponding to maximum draughts to which the ship may be loaded under different conditions of navigation.

1.5.2.2 When assigning a freeboard, it is assumed that the appropriate load lines on the sides of the ship, corresponding to a season of the year and the zone or area in which the ship may be, shall not be submerged at any time when the ship puts to sea, during voyage or on arrival. Exceptions are allowed only for the following cases:

.1 when a ship is in fresh water of unit density the load line corresponding to the season, zone or area of navigation may be submerged by the amount of the fresh water allowance shown on the Load Line Certificate.

Where the density is other than unity, an allowance shall be made proportional to the difference between 1,025 and the actual density;

.2 when a ship departs from a port situated on a river or inland waters, deeper loading shall be permitted corresponding to the mass of fuel and all other materials required for consumption between the port of departure and the sea.

2 LOAD LINE MARKING ON SHIPS

2.1 DECK LINE AND LOAD LINE MARK

2.1.1 Deck line.

The deck line is a horizontal line 300 mm in length and 25 mm in breadth. It shall be marked amidships on each side of the ship, and its upper edge shall normally pass through the point where the continuation outwards of the upper surface of the freeboard deck intersects the outer surface of the side shell.

If the freeboard deck is wood-sheathed amidships, the upper edge of the deck line shall pass through the point where the continuation outwards of the upper surface of the actual deck sheathing intersects the outer surface of the side shell of the ship (refer to [Fig. 2.1.1-1](#)).

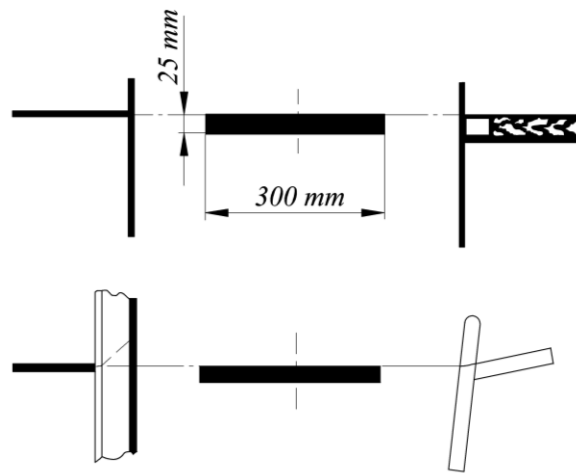

Fig. 2.1.1-1

Where it is impossible or inconvenient to mark the deck line by the above-mentioned method, the deck line may be placed with reference to another fixed point on the ship side in condition that the freeboard is correspondingly corrected. The location of the reference point and the identification of the freeboard deck shall be indicated in the Load Line Certificate. For example, in a ship having a rounded gunwale the upper edge of the deck line may pass through the point *a* and the distance measured from it to the point *b* (where the continuation outwards of the upper surface of the freeboard deck intersects the outer surface of the shell) shall be indicated in the Load Line Certificate (refer to [Fig. 2.1.1-2](#)).

Where a ship has complete superstructure extending along the whole length of the freeboard deck or the lower deck of the ship is taken as a freeboard deck, the assumed minimum freeboard calculated with no correction for the position of the deck line may be such as the deck line shall intersect the ring of the load line mark. In such case, if a ship is assigned a minimum freeboard, the deck line shall be marked on the ship's side in such a manner that it shall be higher than the load line mark and the deepest load line. The appropriate correction for the position of the deck line relative to the freeboard deck shall be taken into account in the calculation and endorsed in the Load Line Certificate.

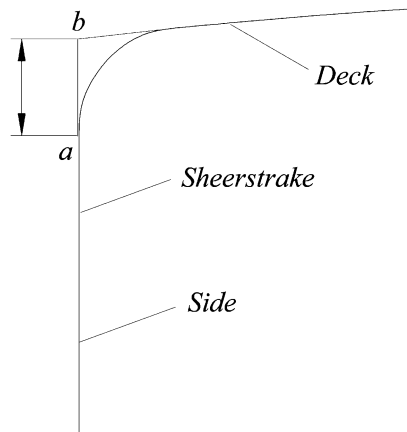

Fig. 2.1.1-2

2.1.2 Load line mark.

The load line mark for each ship shall consist of a ring 300 mm in outside diameter and 25 mm wide divided by a vertical line 25 mm in breadth passing through its centre and intersected by a horizontal line 450 mm in length and 25 mm in breadth, the upper edge of which passes through the centre of the ring.

The centre of the ring shall be placed amidships and at a distance equal to the assigned summer freeboard measured vertically below the upper edge of the deck line (refer to [Fig. 2.1.2](#)).

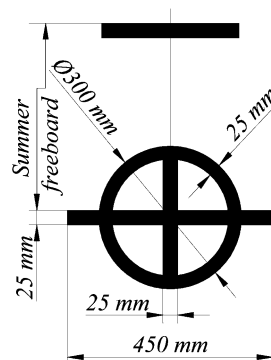

Fig. 2.1.2

2.1.3 Lines to be used with load line mark.

2.1.3.1 Lines on ships assigned minimum freeboards.

The lines which indicate the position of the load waterlines of fishing vessels engaged in international voyages (refer to [Fig. 2.1.3.1-1](#)), ships of 24 m in length and over and fishing vessels not engaged in international voyages (refer to [Fig. 2.1.3.1-2](#)) and ships of restricted area of navigation **R1**, **R2**, **R2-RSN**, **R2-RSN(4,5)**, **R3-RSN** and **R3** (refer to [Fig. 2.1.3.1-3](#)) for loading in different zones, areas and during different seasonal periods of navigation shall be horizontal lines 230 mm in length and 25 mm in breadth which extend forward of, unless expressly provided otherwise, and at right angles to, a vertical line 25 mm in breadth marked at a distance 540 mm forward of the centre of the load line mark ring.

The lines which indicate the position of the load waterlines of restricted areas of navigation **RN(SCI)** and **RN(SCII)** for loading in different zones, areas and during different seasonal periods of navigation, shall be horizontal lines 230 mm in length and 25 mm in breadth marked

at a distance 540 mm and 1200 mm accordingly forward of the centre of the load line mark ring (refer to [Fig. 2.1.3.1-4](#)).

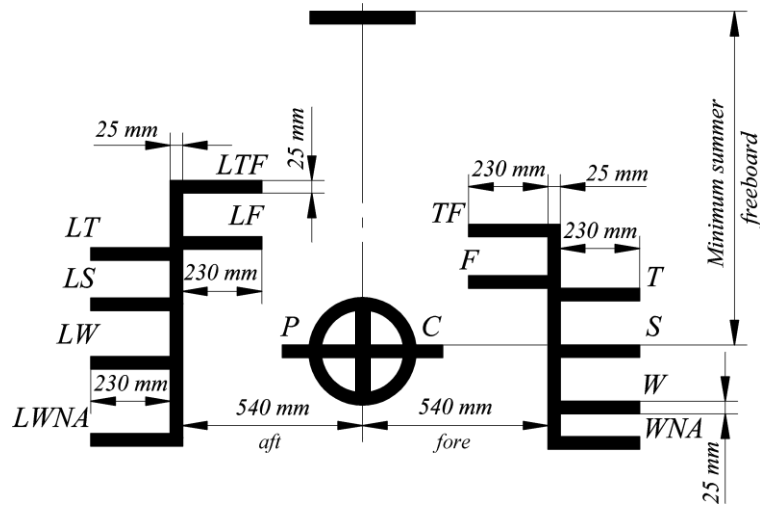

Fig. 2.1.3.1-1

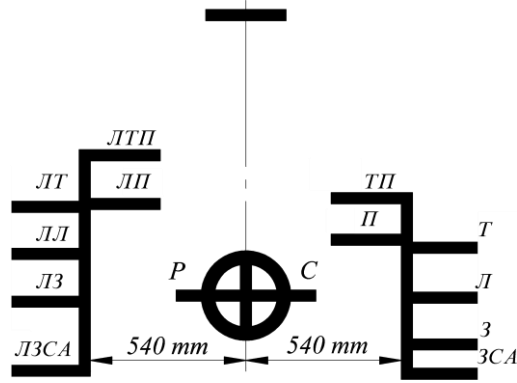

Fig. 2.1.3.1-2

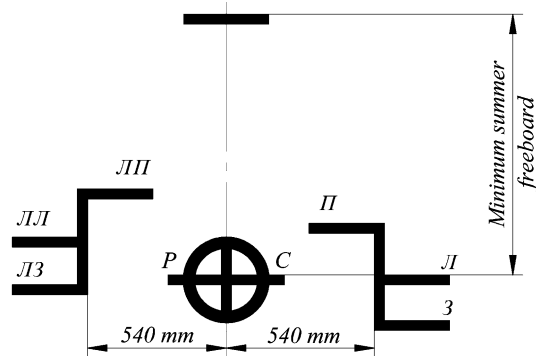

Fig. 2.1.3.1-3

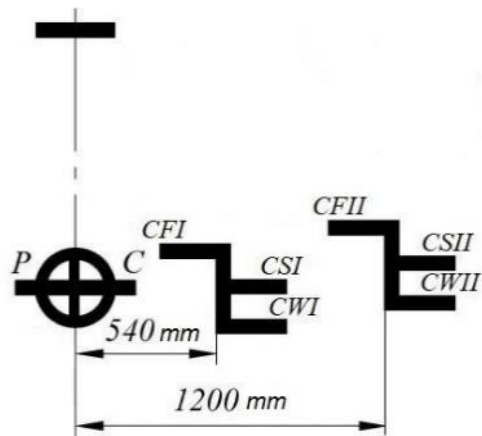

Fig. 2.1.3.1-4

The following load lines shall be used (refer to [Table 2.1.3.1](#)).

Table 2.1.3.1

	Fishing vessels engaged in international voyages	Ships of 24 m in length and more and fishing vessels not engaged in international voyages	Ships of restricted area of navigation R1, R2, R2-RSN, R2-RSN(4,5), R3-RSN and R3
summer load line	indicated by the upper edge of the line which passes through the centre of the ring and also by the upper edge of a line marked <i>S</i>	indicated by the upper edge of the line which passes through the centre of the ring and also by the upper edge of a line marked <i>Л</i>	
winter load line	indicated by the upper edge of a line marked <i>W</i>	indicated by the upper edge of a line marked <i>3</i>	
winter North Atlantic load line	indicated by the upper edge of a line marked <i>WNA</i>	indicated by the upper edge of a line marked <i>3CA</i>	–
tropical load line	indicated by the upper edge of a line marked <i>T</i>	indicated by the upper edge of a line marked <i>T</i>	–
fresh water load line in summer	indicated by the upper edge of a line marked <i>F</i> ¹	indicated by the upper edge of a line marked <i>Л</i> ¹	
tropical fresh water load line	indicated by the upper edge of a line marked <i>TF</i> , and placed abaft the vertical line	indicated by the upper edge of a line marked <i>ТЛ</i> , and placed abaft the vertical line	–

¹ The distance between the fresh water load line in summer and the summer load line is the allowance to be made for loading in fresh water at the other load lines *W(3)* and *WNA(3CA)*.

For ships of the restricted area of navigation **RN(SCI)** the summer load line is applied, which is determined by the upper edge of the line marked with the letters *CSI*, the winter load line, which is determined by the upper edge of the line, marked with the letters *CWI*, and the fresh water load line in summer, which is determined by the upper edge of the line, denoted by the letters *CFI*.

For ships of the restricted area of navigation **RN(SCII)** the summer load line is applied, which is determined by the upper edge of the line, marked with the letters *CSII*, the winter load line, which is determined by the upper edge of the line, marked with the letters *CWII*, and the fresh water load line in summer, which is determined by the upper edge of the line, denoted by the letters *CFII*.

2.1.3.2 Lines on ships assigned minimum timber freeboards.

If timber freeboards are assigned to a cargo ship in accordance with the requirements of [Section 5](#) of these Rules, the timber load lines shall be marked in addition to ordinary load lines. These lines indicating the position of the load waterlines assigned to a ship for loading in different zones, areas and during different seasonal periods of navigation shall be horizontal lines 230 mm in length and 25 mm in breadth which extend abaft, unless expressly provided otherwise, and at right angles to a vertical line 25 mm in breadth marked at a distance 540 mm abaft the centre of the ring of the load line mark (refer to [Figs. 2.1.3.1-1, 2.1.3.1-2 and 2.1.3.1-3](#)).

The following timber load lines shall be used (refer to [Table 2.1.3.2](#)).

Table 2.1.3.2

	Ships of 24 m in length and more not engaged in international voyages	Ships of restricted area of navigation R1, R2, R2-RSN, R2-RSN(4,5), R3-RSN and R3
summer timber load line	indicated by the upper edge of a line marked <i>ЛЛ</i>	
winter timber load line	indicated by the upper edge of a line marked <i>ЛЗ</i>	
winter North Atlantic timber load line	indicated by the upper edge of a line marked <i>ЛЗСА</i>	–
tropical timber load line	indicated by the upper edge of a line marked <i>ЛТ</i>	–
fresh water timber load line in summer	indicated by the upper edge of a line marked <i>ЛП</i>	
tropical fresh water timber load line	indicated by the upper edge of a line marked <i>ЛТП</i>	–

2.1.3.3 Lines on sailing ships assigned minimum freeboards.

On sailing ships only the fresh water load line in summer and the winter North Atlantic load line need be marked associated with the load line mark (refer to [Fig. 2.1.3.3](#)).

Such ships within summer and winter zones, areas and during seasonal periods in salt sea water may be loaded to the upper edge of the horizontal line which passes through the centre of the load line mark ring.

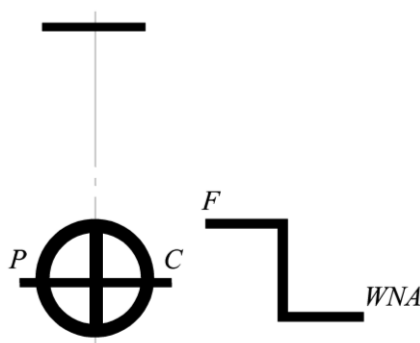

Fig. 2.1.3.3

2.1.3.4 Subdivision load lines.

2.1.3.4.1 The subdivision load line is indicated by the upper edge of the horizontal line 230 mm in length and 25 mm in breadth, marked P and placed at the level of an approved subdivision load line abaft the vertical line mentioned in [2.1.3.1](#).

If the subdivision load line is below the lowest load line referred to in [2.1.3.1](#), it shall be marked abaft the assumed extension of the above vertical line.

2.1.3.4.2 In no case shall any subdivision load line be placed above the deepest load line in salt water as determined for the minimum freeboard of the ship or above the horizontal line of the load line mark on ships with a greater than minimum freeboard.

2.1.3.4.3 The freeboard corresponding to the subdivision load line shall be measured from the deck line mentioned in [2.1.1](#).

2.1.3.5 Load lines on ships assigned a permanent greater than minimum freeboard.

On a ship which is, for some reason, assigned a greater than minimum freeboard, the load line marking shall be carried out as illustrated below (refer to [Fig. 2.1.3.5](#)):

.1 the load line mark (refer to [Fig. 2.1.2](#)) shall be placed below from the deck line at a distance corresponding to a greater than minimum freeboard assigned;

.2 the load line mark shall be indicated together with the fresh water load line as well as with the winter load line and/or with the winter North Atlantic load line (refer to [Table 2.1.3.1](#)) if the winter freeboard and/or the winter North Atlantic freeboard calculated in compliance with these Rules exceed a greater than minimum freeboard assigned to a ship;

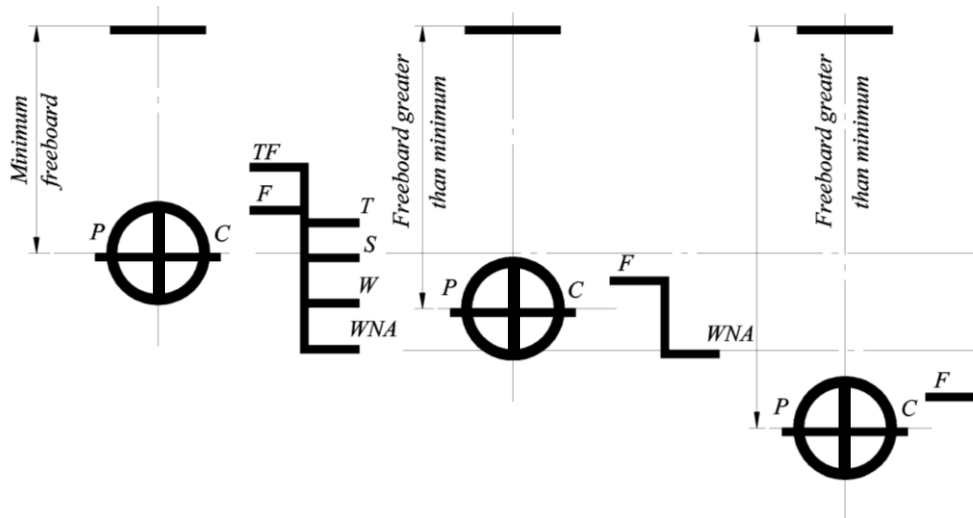

Fig. 2.1.3.5

.3 the allowance for fresh water shall in all cases be based on the draught corresponding to a greater than minimum freeboard assigned to a ship;

.4 except for the fresh water load line no other marks shall be placed above the horizontal line of the load line mark.

2.1.3.6 Subdivision load lines on passenger ships.

The subdivision load line marking for passenger ships shall be carried out as specified below:

.1 on passenger ships intended for carrying the passengers only and whose freeboard corresponding to the deepest subdivision load line is equal to or exceeds the minimum summer freeboard assigned in compliance with these Rules or a greater than minimum freeboard assigned for some other reasons, the load line mark and the subdivision load line are marked at the level of the deepest subdivision load line approved by the Register.

The subdivision load line for these ships is distinguished by the notation P1.

The other load lines are marked as in case for a ship with a greater than minimum freeboard according to [2.1.3.5.2](#) and [2.1.3.5.3](#) (refer to [Fig. 2.1.3.6.1](#));

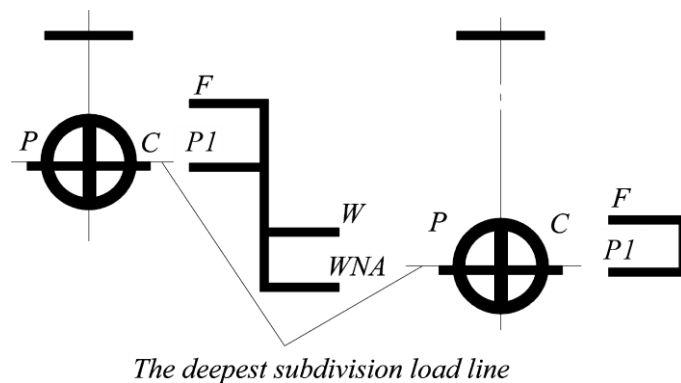

Fig. 2.1.3.6.1

.2 a passenger ship having spaces which are specially adopted for carriage of passengers and cargo alternatively may, if the owners desire, have one or more subdivision load lines assigned and marked to correspond with the subdivision waterlines approved by the Register for the alternative service conditions of the ship.

The subdivision load line marked for the principal condition when carrying passengers is distinguished by the notation P1 and P2, P3, etc. for the rest alternative conditions (refer to [Fig. 2.1.3.6.2](#)).

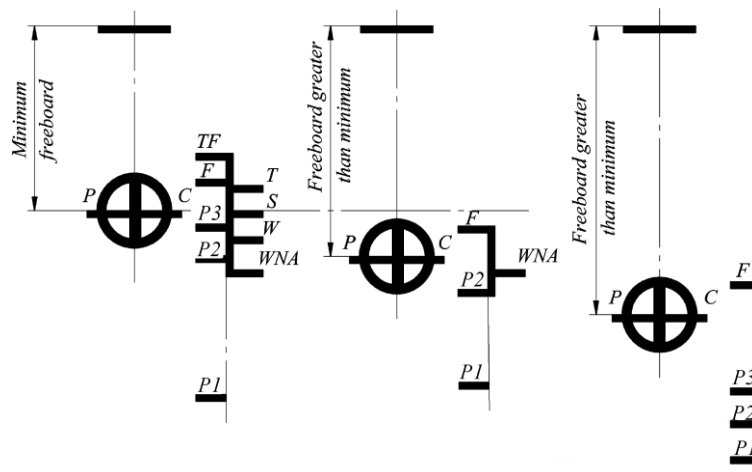

Fig. 2.1.3.6.2

For the case of ship's service with no passengers on board the subdivision marks P1, P2, P3, etc., may be submerged;

.3 the freeboard corresponding to each of the subdivision load lines P1, P2, P3, etc., shall be indicated in the Passenger Ship Safety Certificate.

2.1.3.7 If the ship is assigned doubled freeboard in compliance with [1.1.1.6](#) and/or [1.1.1.7](#), additional load line mark is not indicated on ship's sides.

The additional load lines are marked at a distance of 1200 mm forward including:

for restricted area of navigation **RN(SCII)** (for timber lines, abaft);

for restricted area of navigation **RN(SCI)** at a distance of 540 mm forward from the centre of the ring of the main load line mark (refer to [Figs. 2.1.3.7-1](#) and [2.1.3.7-2](#)).

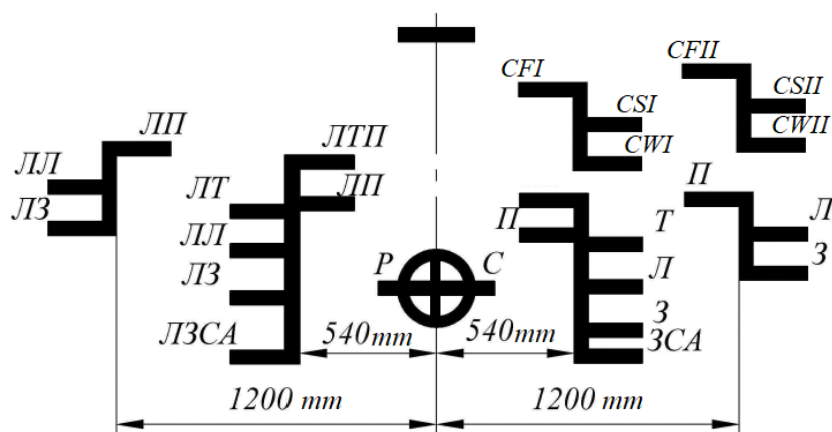

Fig. 2.1.3.7-1

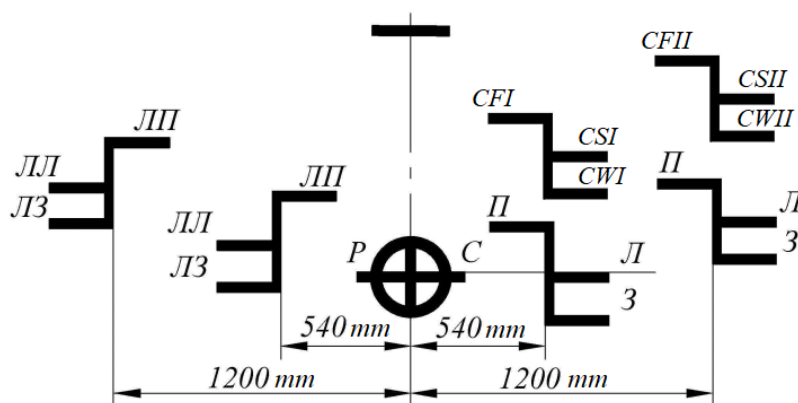

Fig. 2.1.3.7-2

2.1.3.8 Load line designation and marking.

2.1.3.8.1 Seasonal load line designation.

2.1.3.8.1.1 Where the characteristics of a ship or the nature of the ship's service or navigational limits make any of the seasonal load lines inapplicable, these lines may be omitted and the freeboards therefore shall not be indicated in the Load Line Certificate.

2.1.3.8.1.2 Where a winter North Atlantic load line coincides with winter load line at the same vertical line, this load line shall be marked with a letter *W*.

2.1.3.8.1.3 Where subdivision load line coincides with the fresh water load line in summer, this load line shall be marked with letters *PF*.

2.1.3.8.1.4 If assigned a greater than minimum freeboard, a ship shall not be loaded in salt water deeper than the upper edge of the horizontal line of the load line mark when sailing within all the zones, areas and during the seasonal periods except those subject to marking by the appropriate load lines. This line shall not be marked with any letters relating to the navigational conditions.

In the Load Line Certificate the freeboard for load lines corresponding to the zones and seasonal periods (if applicable) not marked on ship's sides shall be that as for the summer load line.

2.1.3.8.1.5 The letters which mark the load lines the outer free ends of which are directed away from the ring shall be placed against these ends of the respective load lines so that the lower edges of the letters are on the level with the upper edges of the lines. It is

recommended that the letters which mark the load lines the free ends of which are directed to the ring, if the distance between load lines permits, shall be placed above the load lines at their free ends. The height of the letters indicating the load lines shall be at least 50 mm.

2.1.3.8.2 Mark of assigning Authority.

The mark of the Authority by whom the load lines are assigned shall be indicated above the horizontal line which passes through the centre of the load line ring. The mark of the Register consists of the letters P and C measuring 115 mm in height and 75 mm in width and placed on ring sides.

2.1.3.8.3 Details of marking.

The ring, lines and letters shall be painted in white or yellow on a dark ground or in black on a light ground. They shall be preliminarily welded to or permanently marked by other method approved by the Register.

On wooden ships they shall be cut into the planking for at least 3 mm depth.

The lines shall be plainly visible and shall be such as to enable freeboard measurements accurate to within ± 2 mm.

3 CONDITIONS OF ASSIGNMENT OF FREEBOARDS

3.1 STRENGTH AND STABILITY OF SHIP

3.1.1 General.

These Rules are framed on the understanding that the nature and stowage of the cargo, ballast, stores, etc. are such as to avoid excessive structural stresses and to provide adequate stability of the ship under any conditions of service.

3.1.2 Strength of ship.

The Register shall be satisfied that the structural strength of the ship is sufficient throughout the entire range of draughts to that draught which corresponds to the assigned summer freeboard in salt water. This applies to the longitudinal and local strength of the hull and superstructures whose scantlings are determined depending on the ship's draught (freeboard), to the strength of bulkheads at the exposed ends of the enclosed superstructures, and also to the strength of the machinery and boiler casings and protective structures thereof, trunks, deckhouses (used for crew's quarters), companionways, etc.

A ship built and maintained in conformity with the Rules of the Register or other recognized classification society shall be considered to possess adequate strength for the particular freeboard.

3.1.3 Information on ship loading.

The master of every new ship to which the provisions of 1.4, Part II "Hull" of the RS Rules/C apply, shall be supplied with sufficient information approved by the Register to enable him to arrange the loading and ballasting of the ship in such a way as to avoid the creation of any unacceptable stresses in the ship's structures.

3.1.4 Stability of ship.

The stability of a ship throughout the entire range of draughts to that draught which corresponds to the least freeboard assigned shall satisfy the requirements of Part IV "Stability" of the RS Rules/C.

3.1.5 Information on ship stability.

The master of every ship shall be supplied with sufficient information approved by the Register to give him guidance as to providing the adequate stability of the ship under different conditions of service. The information shall be drawn up with regard to the provisions of 1.4.11, Part IV "Stability" of the RS Rules/C.

3.2 ARRANGEMENT AND MEANS OF CLOSURE OF OPENINGS IN HULL AND SUPERSTRUCTURES

3.2.1 Position of hatchways, doorways and ventilators.

For the purpose of these Rules, two positions of hatchways, doorways and ventilators are defined as follows:

.1 position 1 – upon exposed freeboard and raised quarter decks, and upon exposed superstructure decks situated forward of a point located a quarter of the ship's length from the forward perpendicular;

.2 position 2 – upon exposed superstructure decks situated outside a quarter of the ship's length from the forward perpendicular located at a height of at least standard superstructure height above the freeboard deck.

Where superstructure height located within a quarter of the ship's length from the forward perpendicular exceeds twice the standard height of the superstructure, the superstructure deck may be related to position 2.

3.2.2 Doors.

3.2.2.1 All access openings in bulkheads at ends of enclosed superstructures shall be fitted with doors of steel or other equivalent material, permanently and strongly attached to the bulkhead, and framed. The doors shall be stiffened and fitted so that the whole structure is of equivalent strength to the unpierced bulkhead and weathertight when closed. The means for securing these doors weathertight shall consist of gaskets and clamping devices or other equivalent means and shall be permanently attached to the bulkhead or to the doors themselves, and the doors shall be so arranged that they can be operated from both sides of the bulkhead.

Doors, which open inwards, shall be allowed on the basis of the substantiation confirming that the hazardous sea exposure thereon is excluded.

3.2.2.2 Except as otherwise provided in these Rules, the height of the sills of access openings in bulkheads at ends of enclosed superstructures shall be at least 380 mm above the deck.

3.2.3 Cargo and other hatchways.

The construction and the means for securing the weathertightness of cargo and other hatchways in positions 1 and 2 shall be at least equivalent to the requirements of [3.2.5](#). The applicability of provisions under [3.2.4](#) to such hatchways shall be determined on the basis of the substantiation provided by the designer, including assessment of seaworthiness and deck flooding.

Where the design specifications stipulate greater assumed loads on hatchway covers than those stated below, the covers shall be calculated for these greater loads. In this case, the requirements concerning the factors of structure strength and deflection, given below, shall be complied with.

These Rules set forth no specific requirements as to coamings and covers of exposed hatchways on decks above the superstructure deck, except for the requirements for non-watertight hatch covers on container ships given in [3.2.14](#).

The possibility to use non-watertight hatch covers for other types of ships shall be determined on the basis of substantiation provided by the designer, including assessment of seaworthiness and deck flooding except for the requirements given in [3.2.14](#).

3.2.4 Hatchways closed by portable covers and secured weathertight by tarpaulins and battening devices.

3.2.4.1 The coamings of hatchways shall be of substantial construction, and their height above the deck shall be at least as follows:

600 mm if in position 1;

450 mm if in position 2.

In fishing vessels, the height of cargo hatchway coamings in position 2 may be reduced down to 300 mm.

3.2.4.2 The width of each bearing surface for hatchways covers shall be at least 65 mm.

3.2.4.3 Where hatchway covers are made of wood the finished thickness shall be at least 60 mm in association with a span of not more than 1,5 m.

3.2.4.4 Where covers are made of steel the strength shall be calculated with assumed loads specified in [3.2.5.2](#) and the product of maximum stress thus calculated and the factor 1,25 shall not exceed the minimum ultimate strength of the material. The design shall be such that the deflection of the covers shall not exceed 0,0056 times the span under these loads.

3.2.4.5 Where portable beams for supporting hatchway covers are made of steel, the strength shall be calculated with the assumed loads not less than 3,5 t/m² on hatchways in position 1, and not less than 2,6 t/m² on hatchways in position 2, and the product of maximum stress thus calculated and the factor 1,47 shall not exceed the minimum ultimate strength of the material. The design shall be such that the deflection of the covers shall not exceed 0,0044 times the span under these loads.

3.2.4.6 For ships less than 100 m in length assumed loads specified in [3.2.4.5](#) may be reduced to the following values: for ships 24 m in length on hatchways in position 1 – to 2,0 t/m² and on hatchways in position 2 – to 1,5 t/m²; for ships of length over 24 m but less than 100 m the values of the assumed loads shall be obtained by linear interpolation, assuming the values specified in [3.2.4.5](#) for ships 100 m in length.

3.2.4.7 Where pontoon covers used in place of portable beams and covers are made of steel, the strength shall be calculated with the assumed loads given in [3.2.5.2](#), and the product of maximum stress thus calculated and the factor 1,47 shall not exceed the minimum ultimate strength of the material. The design shall be such that the deflection of the covers shall not exceed 0,0044 times the span under these loads. Steel plating forming the top of the covers shall be not less in thickness than 1 % of the spacing of stiffeners or 6 mm, whichever is more.

3.2.4.8 The strength and stiffness of covers made of materials other than common carbon steel shall be equivalent to those of carbon steel. Drawings and calculations shall be submitted to the Register for review.

3.2.4.9 Carriers or sockets for portable beams shall be of substantial construction, and shall provide means for the efficient fitting and securing of the beams. Where rolling types of beams are used, the arrangements shall ensure that the beams remain properly in position when the hatchways are closed.

3.2.4.10 Cleats shall be set to fit the taper of the wedges. They shall be at least 65 mm wide and spaced not more than 600 mm centre to centre. The cleats along each side or end shall be not more than 150 mm from the hatch corners.

3.2.4.11 Battens and wedges shall be efficient and in good condition. Wedges shall be of tough wood or other equivalent material. They shall have a cone of not more than 1 : 6 and shall be not less than 13 mm thick at the toes.

3.2.4.12 At least two layers of tarpaulin in good condition shall be provided for each hatchway in position 1 or 2. The tarpaulins shall be waterproof and of ample strength. The tarpaulins shall be of approved standard weight and quality.

3.2.4.13 For all hatchways in position 1 or 2 steel bars or other equivalent means shall be provided in order to secure efficiently and independently each section of hatchway covers after the tarpaulins are battened down. Hatchway covers of more than 1,5 m in length shall be secured by at least two such securing appliances.

Equivalent means for securing used instead of steel bars shall be manufactured from materials which shall provide strength equivalent to, and elasticity of both materials and the whole product not greater than that of, steel. Steel wire ropes cannot be regarded as satisfactory equivalent means for securing.

Where securing devices which do not provide a flat bearing surface are used, care shall be taken that tarpaulins are adequately protected from possible damage.

3.2.5 Hatchways closed by weathertight covers of steel or other equivalent material.

3.2.5.1 All hatchways in position 1 or 2 shall be fitted with covers made of steel or other

equivalent material. Covers shall be weathertight and fitted with gaskets and clamping devices. The means for strengthening and maintaining weathertightness shall comply with the requirements of 7.10.6, Part III "Equipment, Arrangements and Outfit" of the RS Rules/C. The arrangements shall ensure that the tightness can be maintained in any sea conditions. For this purpose, tests for tightness shall be required at the initial surveys, and may be required at annual and renewal surveys or at more frequent intervals.

The coamings of hatchways shall, generally, comply with the requirements of [3.2.4.1](#).

Height of the coamings of hatchways, complying with the requirements of [3.2.5.2 — 3.2.5.3](#), may be reduced as compared to that required by [3.2.4.1](#) and the coamings may be omitted entirely provided that the cover tightness and securing means are found efficient and the following is submitted:

for hatches that are closed at sea — technical background containing operational limitations considering designation and nature of hatch application;

for hatches that may be open at sea — technical background containing assessment of seaworthiness and deck flooding as well as confirmation that the safety of the ship is provided at any sea condition in accordance with the designated area of navigation.

3.2.5.2 Minimum design loads for hatchway covers.

3.2.5.2.1 For ships of 100 m in length and above design loads for hatchway covers shall be calculated in the following way:

.1 position 1 hatch covers located in the forward quarter of the ship's length shall be designed for wave loads, in t/m^2 , at the forward perpendicular, determined by the following formula:

$$Load = 5 + (L_H - 100)a \quad (3.2.5.2.1.1)$$

where L_H is assumed as equal to length L but not exceeding 340 m;

a is given in [Table 3.2.5.2.1.1](#), and reduced linearly to $3,5 t/m^2$ at the end of the forward quarter's length. The design load used for each hatch cover panel shall be such as the one determined at its midpoint location;

Table 3.2.5.2.1.1

	a
Type B freeboard ships	0,0074
Ships assigned reduced freeboard in compliance with 4.1.3.6 or 4.1.3.7	0,0363

.2 all other position 1 hatch covers shall be designed to $3,5 t/m^2$;

.3 position 2 hatch covers shall be designed to $2,6 t/m^2$;

.4 where a position 1 hatchway is located at least one superstructure standard height higher than the freeboard deck, it may be designed to the load specified in [Table 3.2.5.2.3](#) for hatchways located on the superstructure deck.

3.2.5.2.2 For ships 24 m in length, design loads for hatchway covers shall be calculated in the following way:

.1 position 1 hatch covers located in the forward quarter of the ship's length shall be designed for wave loads of $2,43 t/m^2$ at the forward perpendicular and reduced linearly to $2,0 t/m^2$ at the end of the forward quarter's length. The design load used for each hatch cover panel shall be such as the one determined at its midpoint location;

.2 all other position 1 hatch covers shall be designed to $2,0 t/m^2$;

.3 position 2 hatch covers shall be designed to $1,5 t/m^2$;

.4 where a position 1 hatchway is located at least one superstructure standard height higher than the freeboard deck, it may be designed to the load specified in [Table 3.2.5.2.3](#) for hatchways located on the superstructure deck.

3.2.5.2.3 For ships between 24 m and 100 m in length, wave loads shall be obtained by linear interpolation of the values shown in [Table 3.2.5.2.3](#).

Table 3.2.5.2.3

	Longitudinal position		
	Forward perpendicular	0,25L	Aft of 0,25L
<i>L</i> > 100 m			
Freeboard deck	Formula (3.2.5.2.1.1)	3,5 t/m ²	3,5 t/m ²
Superstructure deck	3,5 t/m ²		2,6 t/m ²
<i>L</i> = 100 m			
Freeboard deck	5,0 t/m ²	3,5 t/m ²	3,5 t/m ²
Superstructure deck	3,5 t/m ²		2,6 t/m ²
<i>L</i> = 24 m			
Freeboard deck	2,43 t/m ²	2,0 t/m ²	2,0 t/m ²
Superstructure deck	2,0 t/m ²		1,5 t/m ²

3.2.5.3 All hatch covers shall be so designed as:

.1 the product of the maximum stress determined in accordance with the above loads and the factor of 1,25 does not exceed the minimum upper yield point strength of the material in tension and the critical buckling strength in compression;

.2 the deflection is limited to not more than 0,0056 times the span;

.3 steel plating forming the tops of covers is not less in thickness than 1 % of the spacing of stiffeners or 6 mm, whichever is more;

.4 for the hatch covers of cargo holds the following corrosion additions shall be added to the net thickness required by [3.2.5.3.1](#), [3.2.5.3.2](#) and [3.2.5.3.3](#):

for single skin hatch covers, a corrosion addition is equal to 2,0 mm for all plating and stiffeners of all ship types;

for double skin hatch covers, a corrosion addition is equal to 2,0 mm for top and bottom plating and 1,5 mm for the internal structure for bulk carriers, ore carriers and combination carriers, a corrosion addition is equal to 1,5 mm for top and bottom plating and 1,0 mm for the internal structure of other ship types;

corrosion addition is equal to 1,0 mm for all construction elements of the hatch covers in way of cellular cargo holds intended for containers.

Note. When calculating the stress and deflection of hatchway covers, the design pressure at the hatch cover surface shall be determined proceeding from the above design loads in units of mass by area and from vertical acceleration equal to 1,0g.

3.2.5.4 The means for securing and maintaining weathertightness other than gaskets and clamping devices shall be approved by the Register.

3.2.5.5 Hatch covers which rest on coamings shall be secured in their closed position by means capable of withstanding horizontally acting loads in any sea conditions.

3.2.6 Engine room openings.

3.2.6.1 Engine room openings in position 1 or 2 shall be properly framed and efficiently enclosed by steel casings of ample strength. Where the casings are not protected by any superstructures, trunks or deckhouses approved by the Register, the calculations confirming their strength shall be submitted to the Register for review.

The doors giving access to such casings shall comply with the requirements of [3.2.2.1](#).

The height of the sills shall be at least 600 mm above the deck plating if in position 1, and at least 380 mm if in position 2. Other openings in such casings shall be fitted with equivalent covers, permanently attached in their proper positions.

Where machinery casings are not protected by other structures, double doors complying with the requirements of [3.2.2.1](#) shall be required for ships with assigned reduced freeboards in compliance with [4.1.3.4](#) or [4.1.3.5](#). An inner sill of 230 mm in conjunction with the outer sill of 600 mm shall be provided.

3.2.6.2 Coamings of any fiddley, hatches, funnel, pipes or engine room ventilators in an exposed position on the freeboard or superstructure deck shall be as high above the deck

as is reasonable and practicable. Fiddley hatch openings shall be fitted with strong covers of steel or other equivalent material permanently attached in their proper positions and capable of being secured weathertight.

Where the height of ventilator coamings of an engine room or emergency generator room does not comply with the requirements of [3.2.8.3](#), weathertight closing appliances required under [3.2.8.4](#) shall be used together with other suitable appliances capable to ensure continuous and adequate ventilation of the spaces.

Ventilators necessary to continuously supply the emergency generator room, if this is considered buoyant in the stability calculation or protecting opening leading below, shall have coamings of sufficient height to comply with the requirements of [3.2.8.3](#), without having to fit weathertight closing appliances.

3.2.7 Miscellaneous openings in freeboard and superstructure decks.

3.2.7.1 Manholes and flush scuttles in position 1 and 2 or within superstructures other than enclosed superstructures shall be closed by substantial covers capable of being made watertight. Unless secured by closely spaced bolts, the covers shall be permanently attached with the use of hinges or by another method approved by the Register.

3.2.7.2 Other openings in freeboard decks other than hatchways, engine room space openings, manholes and flush scuttles shall be protected by an enclosed superstructure, or by a deckhouse or companionway of equivalent strength and weathertightness. Any such opening in an exposed superstructure deck or in the top of a deckhouse on the freeboard deck which gives access to spaces below the freeboard deck or spaces within an enclosed superstructure shall be protected by an efficient deckhouse or companionway.

Doorways in such deckhouses or companionways shall be fitted with doors complying with the requirements of [3.2.2](#).

Where the openings within the deckhouses are enclosed by companionways of appropriate strength fitted with doors complying with the requirements of [3.2.2](#), the external doors of the deckhouse need not meet these requirements.

Openings in the top of an efficient deckhouse having a height not less than the standard superstructure height need not be protected by an efficient deckhouse or companionway provided the deckhouse is situated on a raised quarterdeck of at least standard height. These openings shall be provided with closing means approved by the Register.

3.2.7.3 The height of sills the doorways in the bulkheads of the bridge or poop, where the latter comply with the requirements applied to enclosed superstructures, except for provision of additional accesses, shall be at least 600 mm.

The height of the sills to the doorways in the bulkheads of the companionways in position 1, shall be at least 600 mm, and in position 2 – at least 380 mm.

The height of sills to doorways in the bulkheads of the deckhouses leading to the spaces located below the freeboard deck or in the spaces of below located enclosed substructure shall be at least:

600 mm – in position 1, if the deckhouse has no additional access from the above-located deck;

380 mm – in position 1, if such additional access is provided, as well as in position 2.

3.2.7.4 Where superstructures, companionways are not of such a strength as to satisfy the requirements of 3.1.2 or the closing appliances therein do not comply with the requirements of [3.2.2](#), [3.2.7.1](#) — [3.2.7.3](#) and [3.2.12](#), the interior access openings in such superstructures and companionways shall be considered exposed, i.e. situated in the weather deck.

3.2.8 Ventilators.

3.2.8.1 Ventilators in position 1 or 2 to spaces below freeboard deck or decks of enclosed superstructures shall have coamings of steel or other equivalent material, substantially constructed and efficiently connected to the deck.

Ventilators in position 1 shall have coamings of at least 900 mm in height above the deck plating; in position 2 the coamings shall be of a height at least 760 mm above the deck plating.

If a ventilator coaming is more than 900 mm in height, it shall be specially strengthened.

3.2.8.2 Ventilators passing through open superstructures shall have substantially constructed coamings of steel or other equivalent material at the freeboard deck.

3.2.8.3 Ventilators in position 1 the coamings of which extend to more than 4,5 m above the deck, and in position 2 the coamings of which extend to more than 2,3 m above the deck, need not be fitted with closing appliances.

3.2.8.4 Except as provided in [3.2.8.3](#), ventilator openings shall be provided with efficient weathertight closing appliances. In ships of not more than 100 m in length the closing appliances shall be permanently attached. Where not so provided in other ships, they shall be conveniently stowed near the ventilators to which they shall be fitted.

The closing appliances shall be of steel or other equivalent material. The use of wooden plugs and tarpaulin covers in positions 1 and 2 is not acceptable.

3.2.9 Air pipes.

Where air pipes to ballast and other tanks extend above the freeboard or superstructure decks, the exposed parts of the pipes shall be of substantial construction. The height from the deck to the point where liquid may have access below shall be at least 760 mm on the freeboard deck and 450 mm on the superstructure deck. Where these heights may interfere with the working of the ship, a lower height may be approved on the basis of the substantiation provided by the designer, including assessment of seaworthiness and deck flooding. The openings of the air pipes shall be fitted with closing means permanently attached and capable of efficiently preventing sea water from penetrating into the tanks. The closing appliances for the openings of the air pipes situated on exposed decks shall be operated automatically. Pressure-vacuum valves may be accepted on oil tankers and oil tank barges.

3.2.10 Cargo ports and other similar openings.

3.2.10.1 Cargo ports and other similar openings in the sides of ships below the freeboard deck shall be fitted with doors so designed as to ensure watertightness and structural integrity commensurate with the surrounding shell plating.

The number of such openings shall be the minimum compatible with the design and proper working of the ship.

The lower edge of such openings shall generally not be below a line drawn parallel to the freeboard deck at side, which is at its lowest point at least 230 mm above the upper edge of the deepest load line. The lower position of openings may be permitted in exceptional cases, provided that on the basis of the substantiation provided by the designer, including assessment of seaworthiness and deck flooding, the Register makes sure that the ship's safety shall not decrease at any sea condition.

In such cases there shall be provided second inner watertight doors of equivalent strength, leakage detection device and drainage of this compartment to the bilges controlled by an easily accessible screwdown valve or other arrangements approved by the Register. The outer doors shall preferably open outwards.

3.2.10.2 Stern, bow and side doors of large dimensions, when manual devices are not readily accessible or convenient shall be normally secured by means of power systems.

Means of retaining doors watertight shall also be provided for emergency use in case of failure of the power systems.

3.2.11 Scuppers, inlets and discharges and garbage chutes.

3.2.11.1 Discharges led through the shell either from spaces below the freeboard deck or from within superstructures and deckhouses on the freeboard deck fitted with doors complying with the requirements of [3.2.2](#), except as provided in [3.2.11.2](#), shall be fitted with efficient and accessible means for preventing water from passing inboard.

Normally each discharge from piping which have, or may have, open ends within the said spaces shall be fitted with one non-return valve with a positive means of closing it from a position above the bulkhead deck in ships having the subdivision mark in the class notation, and from a position above the freeboard deck in other ships. The means for operating the

positive action valves shall be readily accessible and provided with an indicator showing whether the valve is open or closed.

An equivalent to one non-return valve with a positive means of closing shall be one non-return valve and one sluice valve controlled from above the bulkhead deck or the freeboard deck, respectively.

In ships having no subdivision distinguishing mark in the class notation the valve drives of sanitary discharges and scuppers led overboard through the shell in way of manned engine rooms may be locally operated.

Where, however, the vertical distance from the summer load waterline (for ships with timber freeboard, from the summer timber load waterline), to the inboard open end of the discharge pipe exceeds $0,01L$, the discharge pipe may have two non-return valves without positive means of closing. In this case, one of the valves is installed at side and inboard valve is above the deepest waterline in salt water assigned to the given ship and shall be always accessible under service conditions. Where a locally controlled sluice valve is interposed between the two non-return valves the inboard non-return valve may be situated below the deepest waterline in salt water assigned to the ship.

Where this distance to the inboard open end of the discharge pipe exceeds $0,02L$, a single non-return valve without positive means of closing may be installed at side. In this case, in ships complying with the requirements of Part V "Subdivision" of the RS Rules/C, a single valve may be fitted only where the distance from the inboard end of the discharge pipe to the damage waterline is not less than 300 mm.

The above requirements for the installation of non-return valves do not apply to discharges which shall be compulsorily closed at sea, for example, openings for gravity draining of topside ballast tanks. Sluice valves controlled from the deck are sufficient for such discharges.

Garbage chutes, instead of a non-return valve with positive means of closing from a position above the freeboard deck, may be provided with two gate valves operated from the deck, where the garbage chute is charged, and incorporating an interlocking system. The lower gate valve shall be additionally operated from a position above the freeboard deck. The two gate valves shall be so spaced that the interlocking system cannot be rendered inoperative.

It is recommended that the charging end of the garbage chute rises to a height of at least 1000 mm above the waterline at the ship summer (summer timber, if applicable) load line draught and remains above the waterline when the ship lists up to $8,5^\circ$ either way from this position.

If the charging end of the garbage chute rises above the summer (summer timber, if applicable) waterline to a height exceeding $0,01L$, the gate valve need not be operated from a position above the freeboard deck, provided that the gate valve at the side is accessible at all times under service conditions.

As an alternative to this the upper gate valve may be replaced by hinged cover fitted to the charging end of the garbage chute and impenetrable to ingress of sea water. Coincidentally with such replacement a damper shall be fitted instead of the lower gate valve. The cover and the damper shall be interlocked to prevent them from being simultaneously opened.

Structural components of the garbage chute, including the cover, shall have thickness sufficient to impart strength.

The control gear of the gate valves and/or hinged cover shall be conspicuously marked: "Keep closed when not in use".

The charging end of the garbage chute shall be situated at a height of 300 mm above the margin line in a passenger ship or the deepest damage waterline in a cargo ship covered by the requirements of Part V "Subdivision" of the RS Rules/C. Otherwise the charging end of a garbage chute in such ships shall have a non-return water tight cover/valve fitted in an easily accessible place above the deepest load line with a screw gear operated from a position above the bulkhead deck provided with open/closed indicators and marking "Keep closed when not in use".

3.2.11.2 Scuppers which penetrate the shell and originate from enclosed superstructures intended for cargo may only be fitted on condition the freeboard deck side line is immersed with the ship listed more than 5°. In other cases the drainage shall be led inboard in accordance with the requirements of 7.12, Part VIII "Systems and Piping" of the RS Rules/C.

3.2.11.3 In manned engine rooms spaces main and auxiliary sea inlets and discharges in connection with the operation of machinery may be controlled locally. The controls shall be readily accessible and shall be provided with indicators showing whether the valve is open or closed.

Fully-automated engine rooms shall, as for the control by the said valves, be considered as equivalent to manned engine rooms, provided suitable warning devices are incorporated to indicate leakage of water into these spaces.

3.2.11.4 Scuppers and discharge pipes originating from exposed decks and spaces other than those mentioned in [3.2.11.1](#) and penetrating the shell either more than 450 mm below the freeboard deck or less than 600 mm above the summer load waterline shall be provided with non-return valves at the shell.

These valves may be omitted, when the thickness of piping where it passes through enclosed superstructure and below the freeboard deck, is not less than specified in [3.2.11.8](#).

3.2.11.5 Scuppers leading from superstructures and deckhouses which have access openings not fitted with doors complying with the requirements of [3.2.2](#) shall be led overboard.

3.2.11.6 All shell fittings and valves required by this paragraph shall be of steel, bronze or other ductile material approved by the Register.

Valves of grey cast iron or other similar material are not acceptable.

All pipes which are covered by this paragraph shall be made of steel or other equivalent material approved by the Register.

3.2.11.7 Unless otherwise specified in these Rules, scuppers and discharge pipes shall have wall thickness not less than the following:

4,5 mm, where the external pipe diameter does not exceed 155 mm;

6,0 mm, where the external pipe diameter is 230 mm or more.

Intermediate values shall be determined by linear interpolation.

3.2.11.8 Any scuppers and discharge pipes within the area between the shell and the closest valve thereto required by these Rules shall have wall thickness not less than the following:

7,0 mm, where the external pipe diameter does not exceed 80 mm;

10,0 mm, where the external pipe diameter equals 180 mm;

12,5 mm, where the external pipe diameter is 220 mm or more.

Intermediate values shall be determined by linear interpolation.

[Fig. 3.2.11](#) provides the acceptable arrangements of scuppers, inlets and discharges.

Load Line Rules for Sea-Going Ships (Section 3)

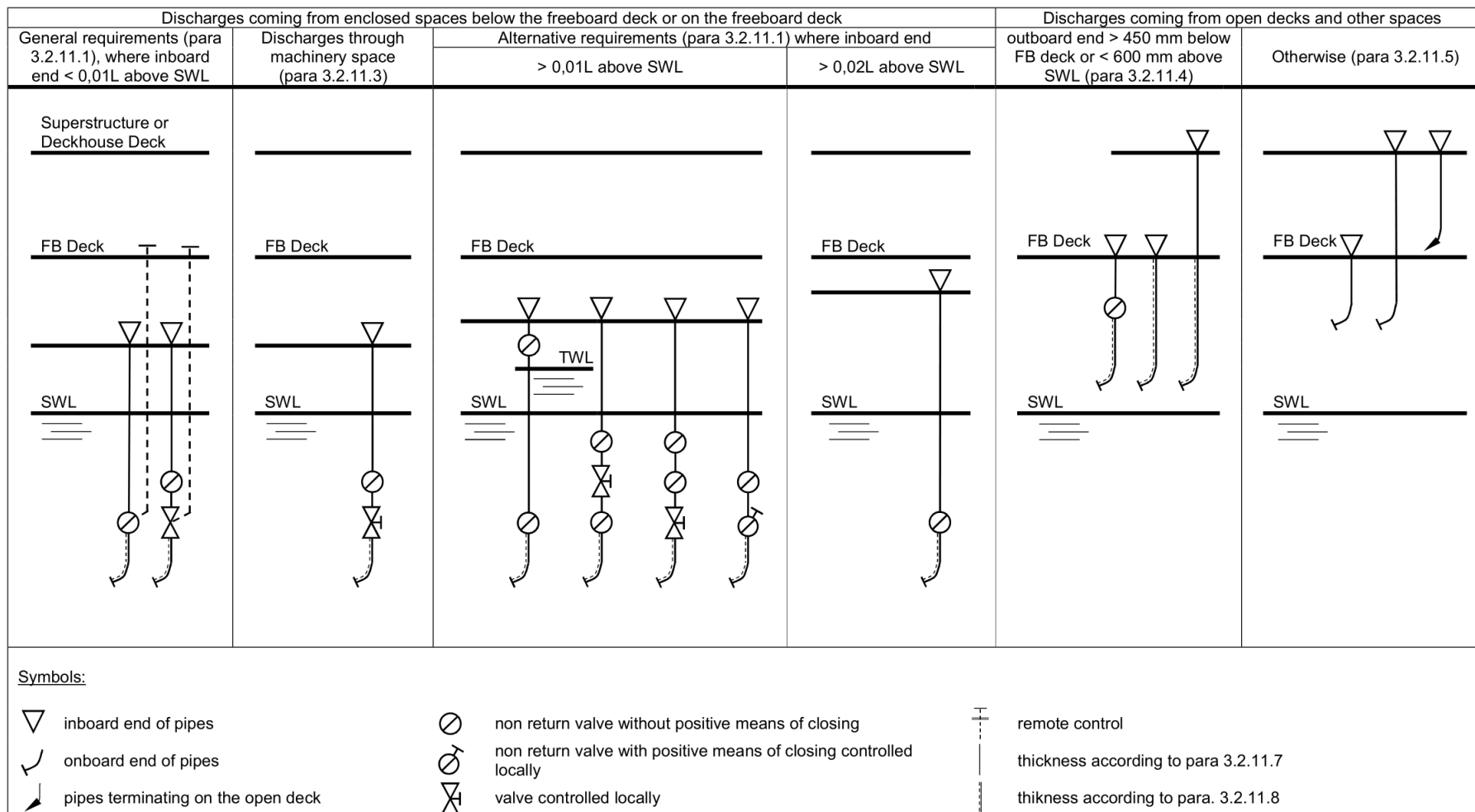

Fig.3.2.11

3.2.12 Side scuttles, windows and skylights.

3.2.12.1 Side scuttles and windows, together with their glasses and deadlights, if fitted, shall be of substantial construction approved by the Register.

Scuttle mean round or oval openings of not more than 0,16 m² in area. Windows are generally rectangular openings with rounded off angles. Round or oval openings of more than 0,16 m² in area are commonly regarded as windows.

3.2.12.2 Side scuttles shall be fitted with efficient hinged inside deadlights, if they are fitted: below the freeboard deck, within enclosed superstructures of the first tier, within deckhouses and companionways on the freeboard deck which protect access openings to spaces situated below or the buoyancy of which is allowed for in the stability calculations.

3.2.12.3 Deadlights required by these Rules shall ensure watertight closure of scuttles fitted below the freeboard deck and weathertight closure of scuttles and windows fitted above the freeboard deck.

3.2.12.4 No side scuttle shall be fitted in a position that its sill is below a line drawn parallel to the freeboard deck at side having its lowest point located 2,5 % of the ship's breadth above the summer load line (or above timber summer load line, if this load line is assigned to the ship) or 500 mm, whichever is the greater distance.

3.2.12.5 In ships assigned freeboard with regard to the damage stability requirements, side scuttles which may immerse at any stage of flooding or equalization of the ship in any damage condition under consideration (except for the case of damage to the compartment where they are fitted) shall be of non-opening type.

3.2.12.6 No window shall be fitted in areas listed in [3.2.12.2](#).

Windows and side scuttles fitted in side plating within superstructure of the second tier which protect direct access downwards or allowed for in the stability calculations shall be fitted with efficient hinged inside deadlights.

Recessed windows and side scuttles fitted within superstructures and deckhouses of the second tier, which protect direct access downwards to spaces listed in [3.2.12.2](#) shall be fitted with deadlights hinged inside, or if an access thereto is provided, with deadlights permanently attached outside.

Deadlights may not be fitted to windows and scuttles in spaces within superstructures of the second tier if cabin bulkheads and doors separate these scuttles or windows from unprotected access downwards and where these spaces are considered buoyant in the stability calculations.

3.2.12.7 Deckhouses situated on a raised quarterdeck, on a superstructure deck or on a deckhouse top having the height less than the standard height, may be treated, with respect to the deadlight requirements, as situated in the second tier, provided that the height of the raised quarterdeck, superstructure or deckhouse is not less than the standard quarterdeck height.

3.2.12.8 The glass for windows in the covers of skylights shall have a thickness consistent with the dimensions of windows and their position on board ship, as it is required for side scuttles and windows. Windows in the covers of skylights, regardless of their position on board ship shall be protected from mechanical damages, and when located in position 1 or 2, they shall be fitted with deadlights permanently attached inside or outside.

3.2.13 Freeing ports.

3.2.13.1 Where bulwarks on the weather portions of freeboard or superstructure decks form wells, ample provision shall be made for rapidly freeing the decks of water and for draining them.

Except as provided in [3.2.13.2](#), [3.2.13.3](#) and [3.2.13.4](#), the minimum freeing port area A , m², on each side of the ship for each well in position 1 shall be that given by the following formulae in cases where the sheer in way of the well is standard or greater than standard. The minimum area for each well on superstructure decks in position 2 shall be one-half of the area given by these formulas

Where the length of bulwark l in the well is 20 m or less

$$A = 0,7 + 0,035l. \quad (3.2.13.1-1)$$

Where l exceeds 20 m

$$A = 0,07l. \quad (3.2.13.1-2)$$

l need in no case be taken as greater than $0,7L$.

If the bulwark is more than 1,2 m in average height, the required area shall be increased by $0,004 \text{ m}^2$ per metre of length of well for each 0,1 m difference in height. If the bulwark is less than 0,9 m in average height, the required area may be decreased $0,004 \text{ m}^2$ per metre of length of well for each 0,1 m difference in height.

3.2.13.2 In ships with no sheer the area calculated in accordance with [3.2.13.1](#) shall be increased by 50 %. Where the sheer is less than standard, the percentage shall be obtained by linear interpolation.

3.2.13.3 In a flush deck ship with a substantial deckhouse amidships, which has a breadth at least $0,8B$ and passageways along the sides of the ship not exceeding 1,5 m, the freeing port area on each side may be calculated in accordance with [3.2.13.1](#) for each part of the well forward of, and abaft, the deckhouse, based upon their length, but not for the whole well with limitation of its length by the value of $0,7L$.

Where an effective screen bulkhead is fitted completely across the ship, at the forward end of a midship deckhouse, the freeing port area may be calculated for the wells forward of, and abaft, this bulkhead without limitations to the deckhouse breadth.

3.2.13.4 Where a ship is fitted with a trunk which does not comply with the requirements of [4.2.4.1.5](#) or where continuous (or substantially continuous) longitudinal hatchway side coamings are fitted between detached superstructures the minimum area of the freeing port openings shall be obtained from [Table 3.2.13.4](#).

Table 3.2.13.4

Breadth of hatchway or trunk in relation to the breadth of ship, %	Area of freeing ports in relation to the total area of the bulwark, %
40 and less	20
75 and more	10

Note. The area of freeing ports at intermediate breadths shall be obtained by linear interpolation.

3.2.13.5 Where passageways formed by interruptions in hatchways side coamings are fitted between detached superstructures, the necessary area of freeing ports shall be determined as follows:

.1 minimum area of freeing ports in a bulwark shall be determined in accordance with [3.2.13.1](#) and [3.2.13.2](#) if limited by the well height the total area of passageways with due regard to equipment fitted between the hatchways is not less than the value calculated in accordance with [3.2.13.4](#) when the hatchway coamings are assumed to be continuous;

.2 minimum area of freeing ports in a bulwark shall be determined in accordance with [3.2.13.4](#) if limited by the well height the total area of the passageways with due regard for the equipment fitted between the hatchways is equal to or less than the value according to [3.2.13.1](#) and [3.2.13.2](#);

.3 minimum area of freeing ports in a bulwark A , m^2 , where the area of passageways between hatchways is less than given in [3.2.13.5.1](#), but more than given in [3.2.13.5.2](#) above can be determined by interpolation using the formula

$$A = A_1 + A_2 - f_p \quad (3.2.13.5.3)$$

- where A_1 = minimum area of the freeing ports calculated in accordance with [3.2.13.1](#) and [3.2.13.2](#), where the coamings are considered to have passageways sufficient for water flowing, m²;
 A_2 = minimum area of the freeing ports calculated in accordance with [3.2.13.4](#), where the coamings are considered to be continuous, m²;
 f_p = limited by the well height the total area of passageways with due regard for the equipment fitted on the deck between hatchways, m².

3.2.13.6 in ships having superstructures which are open at either or both ends, the area of the freeing ports for such superstructures and for the wells formed by the bulwark on the open deck and communicating with the open superstructure shall be calculated according to the following procedure:

.1 the freeing port area in the bulwark which encloses a well communicating with the open superstructure shall be calculated in full compliance with [3.2.13.1](#) and [3.2.13.2](#), except that Formulae ([3.2.13.1-1](#)) or ([3.2.13.1-2](#)) for determination of the minimum area A shall be chosen depending on the common length l_t of the well and open space within the superstructure but the length l_w of the well considered shall be used in the calculation;

.2 minimum area A for the open superstructure shall be calculated by Formula ([3.2.13.1-1](#)) or ([3.2.13.1-2](#)), l_t is used as an assumed length. The area just obtained shall be multiplied by the factor $(b_0/l_t)(1 - (l_w/l_t)^2)$ to adjust the freeing port area for the breadth b_0 of the opening in the bulkhead between the superstructure and the well and the relationship of well and superstructure lengths. The area corrected in compliance with [3.2.13.2](#) is the freeing port area for the open superstructure on the freeboard deck;

.3 where the open superstructure and the well are located in position 2, the areas thus obtained shall be multiplied by the factor

$$0,5h_{st}/h_w$$

- where h_{st} = standard height of the superstructure;
 h_w = distance of the well deck above the freeboard deck.

3.2.13.7 The lower edges of the freeing ports in a bulwark and passageways specified in [3.2.13.5](#) shall be as near the deck as practicable. Two-thirds of the freeing port and passageway area required shall be provided in the half of the well length nearest the lowest point of the sheer curve. In ships with no sheer in way of the wells the freeing port and passageway area shall be uniformly spread along the length of the wells.

3.2.13.8 The freeing port openings in the bulwark shall be protected by guard rails or bars spaced approximately 230 mm apart. If shutters are fitted to freeing ports, ample clearance shall be provided to prevent jamming.

Hinges shall have pins or bearings of non-corrodible material. If shutters are fitted with securing appliances, these appliances shall be of construction approved by the Register.

Freeing ports of tugs, escort tugs and anchor handling ships operating during winter periods and within winter seasonal zones shall not be fitted by shutters.

3.2.14 Non-weathertight hatch covers above superstructure deck.

3.2.14.1 Non-weathertight hatch covers may be used on container ships.

3.2.14.2 Such hatch covers may be fitted to cargo hatchways located on weather decks which are at least two standard superstructure heights above an actual freeboard deck or an assumed freeboard deck to which the minimum freeboard less than or equal to the freeboard actually assigned corresponds. Where a hatchway or a part thereof is forward of a point located one quarter of the ship length ($0,25L$) from the forward perpendicular, that hatchway shall be located on a weather deck at least three standard superstructure heights above the actual or assumed freeboard deck. The assumed freeboard deck is used only for the purpose of measuring the height of the deck on which hatchways are situated and may be an imaginary, or virtual deck.

3.2.14.3 Hatchway comings shall be not less than 600 mm in height.

3.2.14.4 Non-weathertight gaps between hatch cover panels shall be considered as unprotected openings with respect to the requirements of intact and damage stability calculations. The gaps shall be as small as possible and, as a rule, shall not exceed 50 mm.

3.2.14.5 Labyrinths, gutter bars, or equivalents shall be fitted proximate to the edges of each panel in way of gaps to minimize the amount of water that can enter in the hold from the top surface of each panel.

3.2.14.6 Scantlings of hatch cover panels as well as details on securing arrangements shall be equivalent to those for weathertight covers determined in accordance with 7.10, Part III "Equipment, Arrangements and Outfit" of the RS Rules/C. For the cover components, corrosion additions specified in [3.2.5.3.4](#) are applicable.

3.2.14.7 If a fixed gas fire extinguishing system is fitted in the hold, the capacity of the system shall be increased by 10 % over that for the same vessel with weathertight hatch covers, provided gaps between hatches are not more than 50 mm. Alternatively, a fixed pressure water-spraying system shall be provided.

3.2.14.8 The bilge system for cargo holds with non-weathertight hatches shall have sufficient additional capacity for water ingress based on a steady rainfall of 100 mm/h applied through the total area of gaps between panels or the capacity of the sprinkler system where fitted, whichever is the greater.

The inner diameter of the bilge main shall be in accordance with the increased bilge pump capacity. Bilge alarms shall be provided in each cargo hold fitted with non-weathertight covers.

3.12.14.9 Container holds fitted with non-weathertight hatch covers on ships intended to carry dangerous goods shall be considered as open-top container holds with respect to stowage and compatibility of dangerous goods.

3.2.15 Spurling pipes and cable lockers.

3.2.15.1 Spurling pipes and cable lockers shall be watertight up to and including the weather deck.

3.2.15.2 Access openings to cable lockers shall be closed by substantial covers secured by closely spaced bolts.

3.2.15.3 Spurling pipes through which anchor cables are led shall be fitted with permanently attached closing appliances to minimize water ingress.

3.3 PROTECTION OF THE CREW

3.3.1 Guard rails and bulwarks.

Efficient guard rails or bulwarks shall be fitted on all exposed parts of the freeboard deck and the decks of superstructures, trunks and deckhouses.

The height of the bulwarks or guard rails shall be at least 1 m from the deck. However, where this height interferes with the normal operation of the ship, a lesser height may be approved on the basis of the substantiation provided by the designer, confirming protection of the crew.

Guard rails fitted on superstructure and freeboard decks shall have at least three courses. The opening below the lowest course of the guard rails shall not exceed 230 mm. The other courses shall be not more than 380 mm apart. In the case of ships with rounded gunwales, the guard rail supports shall be placed on the flat of the deck.

In other locations guard rails with at least two courses shall be fitted.

Fixed, removable or hinged stanchions shall be fitted about 1,5 m apart. Structure of stanchions, as well as of chains and wire ropes shall comply with the requirements set forth in [Notes 1 — 5](#) of [3.3.2](#).

3.3.2 Means of access.

The protection of crew in getting to and from their quarters, the engine room and all other parts used in the necessary work of the ship shall be provided by at least one of the means of access denoted in [Table 3.3.2](#) depending on the ship type and the assigned summer freeboard.

Table 3.3.2

Type of ship	Locations of access in ship	Assigned summer freeboard, in mm	Acceptable arrangements according to type of ship ¹			
			Type A	Type B-100	Type B-60	Type B, B +
1. All ships other than oil tankers, chemical tankers and gas carriers	1.1 Access to midship quarters 1.1.1 Between poop and bridge, or 1.1.2 Between poop and deck-house containing living accommodation and/or navigating equipment	≤ 3000	a	a	a, b, c(1)	a b c(1) c(2) c(4) d(1) d(2) d(3) e f(1) f(2) f(4)
			b	b	e	
			e	e	f(1)	
		> 3000	a	a	a, b	
			b	b	c(1), c(2)	
			e	e	e	
	1.2 Access to ends 1.2.1 Between poop and bow (if there is no bridge) 1.2.2 Between bridge and bow, or 1.2.3 Between deckhouse containing living accommodation and/or navigating equipment and bow, or 1.2.4 In flush deck vessel, between crew accommodation and forward or after ends of ship	≤ 3000	a	a	a	
			b	b	b	
			c(1)	c(1), c(2)	c(1), c(2)	
			e	e	e	
		> 3000	f(1)	f(1), f(2)	f(1), f(2)	
			a	a	a	
			b	b	b	
			c(1)	c(1), c(2)	c(1), c(2), c(4)	
f(1)	d(1)	d(1), d(2)	d(1), d(2), d(4)			
	e	e	e			
f(1)	f(1)	f(1), f(2)	f(1), f(2), f(4)			
2. Oil tankers, chemical tankers and gas carriers	2.1 Access to bow 2.1.1 Between poop and bow, or 2.1.2 Between a deckhouse containing living accommodation and/or navigating equipment and bow 2.1.3 In flush deck vessel, between crew accommodation and the forward ends of ship	≤ (A _f + h _s) ²	e			
			f(1)			
		> (A _f + h _s) ²	f(5)			
	a					
	2.2 Access to after end 2.2.1 In flush deck vessel, between crew accommodation and the after end of ship	As required in 1.2.4 for other types of ships		e		
		f(1)				
				f(2)		

¹ For the application purpose of this Table the following ship types shall be determined: type A is defined in [4.1.2](#), type B is defined in [4.1.3](#), type B-60 is defined in [4.1.3.6](#), type B-100 is defined in [4.1.3.7](#), type B+ is defined in [4.1.3.8](#).

² A_f is the minimum summer freeboard of type A ship; h_s is the standard height of superstructure.

Acceptable arrangements referred to in [Table 3.3.2](#) are defined as follows:

a – a well lighted and ventilated underdeck passageway (clear opening 0,8 m wide, 2,0 m high) as close as practicable to the freeboard deck, connecting and providing access to the locations in question;

b – a permanent and efficiently constructed gangway fitted at or above the level of superstructure deck on or as near as practicable to the center line of the ship, providing a continuous platform of at least 0,6 m in width with a non-slip surface, with guard rails extending on each side throughout its length. Guard rails shall be of at least 1 m high with courses as required in [3.3.1](#), and supported by stanchions spaced not more than 1,5 m apart; a foot-stop shall be provided;

c – a permanent passageway of at least 0,6 m in width fitted at freeboard deck level consisting of two rows of guard rails complying with the requirements of [3.3.1](#), with stanchions spaced not more than 3 m apart. On type B ships hatchway coamings of not less than 0,6 m in height may be regarded as forming one side of the passageway, provided that two rows of guard rails are fitted between hatchways;

d – a 10 mm minimum diameter wire rope lifeline supported by stanchions spaced about 10 m apart, or a single hand rail or wire rope attached to hatch coamings, continued and adequately supported between hatchways;

e – a permanent and efficiently constructed gangway fitted at or above the level of the superstructure deck on or as near as practicable to the center line of the ship, and:

located so as not to hinder easy access across the working areas of the deck;

providing a continuous platform of at least 1,0 m in width (for oil tankers of less than 100 m in length, and of at least 0,6 m in width);

constructed of fire resistant and non-slip material;

fitted with guard rails of at least 1,0 m in high supported by stanchions spaced not more than 1,5 m apart and complying with the requirements of [3.3.1](#);

provided with a foot-stop on each side;

having openings to and from the deck, with ladders where appropriate, which shall not be spaced more than 40 m apart;

having shelters of substantial construction set in way of the gangway at intervals not exceeding 45 m if the length of the exposed deck to be traversed exceeds 70 m. Every such shelter shall be capable of accommodating at least one person and be constructed so as to afford weather protection on the forward, port and starboard sides;

f – a permanent and efficiently constructed passageway fitted at freeboard deck level or as near as practicable to the center line of the ship having the same specifications as those for a permanent gangway listed in (*e*) except for foot-stops. On type B ships (certified for the carriage of liquid cargoes), with a combined height of hatch coaming and fitted hatch cover together not less than 1 m, hatchway coamings may be regarded as forming one side of the passageway, provided that between hatchways two rows of guard rails are fitted.

Where necessary, alternative transverse locations for (*c*), (*d*) and (*f*) may be the following:

- (1) fitted at the center line of the ship or near to it (on deck or on hatch covers);
- (2) fitted on each side of the ship;
- (3) fitted on one side of the ship, provision being made for fitting on either side;
- (4) fitted on one side only;
- (5) fitted on each side of hatchways as near to the center line as practicable.

Notes: 1. In all cases where wire ropes are fitted, the adequate devices shall be provided to ensure their tautness.

2. Wire ropes may be accepted instead of guard rails only in special cases and then only in limited lengths.

3. Lengths of chain may be accepted instead of guard rails only if fitted between two fixed stanchions.

4. Where stanchions are fitted, every third stanchion shall be supported by a bracket or stay.

5. Removable or hinged stanchions shall be capable of being locked in the upright position.
6. A possibility of passage over obstructions, if any, such as pipes or other permanent fittings shall be provided.
7. As a rule, the width of the gangway or deck-level passageway shall not exceed 1,5 m.

3.3.3 Deck cargo stowage.

Deck cargo carried on any ship shall be so stowed that any opening which is in way of the cargo and which gives access to and from the crew's quarters, the engine room and all other parts used in the necessary work of the ship, can be properly closed and secured against the admission of water. Effective protection for the crew in the form of guard rails or life lines shall be provided above the deck cargo if there are no convenient passages on or below the deck of the ship.

3.4 SPECIAL CONDITIONS OF ASSIGNMENT OF FREEBOARD FOR TYPE A SHIPS

3.4.1 Machinery casings.

Machinery casings on type A ships as defined in [4.1.2.1](#) shall be protected by an enclosed poop or bridge of at least standard height, or by a deckhouse of equal height and equivalent strength. Machinery casings may be exposed if there are no openings in them giving direct access from the freeboard deck to the engine room. A door complying with the appropriate requirements of [3.2.2.1](#) and having a sill not less than 600 mm in height if in position 1 and not less than 380 mm in height if in position 2 may, however, be permitted in the machinery casing, provided that it leads to a space or passageway which is as strongly constructed as the casing and is separated from the stairway to the engine room by a second weathertight door of steel or other equivalent material with a sill not less than 230 mm in height.

3.4.2 Gangway and means of access.

Gangways and means of access shall comply with the requirements of [Table 3.3.2](#) having regard to the type of ship and the summer freeboard.

3.4.3 Hatchways.

Exposed hatchways in position 1 and on the tops of expansion trunks on type A ships shall be provided with efficient watertight covers of steel or other equivalent material.

3.4.4 Freeing arrangements.

Type A ships with bulwarks shall generally have open rails fitted for at least half the length of the exposed parts of the weather deck. If the continuous bulwark is fitted, the area of freeing ports in the lower part of the bulwark shall not be less than 33 % of its total area. The upper edge of the sheer strake shall be kept as low as practicable.

Where superstructures are connected by trunks, open rails shall be fitted for the whole length of the exposed parts of the freeboard deck.

Where the height of bounding coamings fitted on the deck to prevent oil from spillage during cargo handling operations is more than 300 mm, freeing ports complying with the requirements of [3.2.13](#) shall be arranged therein. Freeing port covers shall be stowed and secured when at sea so that not to interfere with drainage of the decks.

3.5 SPECIAL CONDITIONS OF ASSIGNMENT OF FREEBOARDS

3.5.1 The height of door sills, hatchway, ventilator coamings and air pipes may be reduced in ships of restricted area of navigation **R2**, **R2-RSN**, **R2-RSN(4,5)** and **R3-RSN** except for ships of unrestricted service, passenger ships and sailing ships irrespective of their area of navigation as well as ships of restricted area of navigation **R1**, **R2**, **R2-RSN**, **R2-RSN(4,5)** and **R3-RSN** operating in northern seas (the Kara Sea, the Laptev Sea, the East Siberian Sea, the Chukchi Sea), in the Bering Sea and the Sea of Okhotsk.

The extent of this reduction depends on the navigation conditions and design features of the ship and shall be determined in each case on the basis of the substantiation provided by the designer, including assessment of seaworthiness and deck flooding. In no case shall reduced heights be less than those given below for ships of restricted area of navigation **R3**.

3.5.2 In ships of restricted area of navigation **R3**, except for passenger ships, the height of door sills, hatchway and ventilator coamings and air pipes may be reduced as follows:

- .1 the height of door sills, as given in [3.2.2.2](#), down to 230 mm;
- .2 the height of hatchway coamings, as given in [3.2.4.1](#), down to 450 mm in position 1 and to 380 mm in position 2;
- .3 the height of door sills, as given in [3.2.6.1](#) and [3.2.7.3](#), from 600 mm down to 450 mm and from 380 mm down to 230 mm;
- .4 the height of ventilator coamings, as given in [3.2.8.1](#), down to 760 mm in position 1 and to 600 mm in position 2;
- .5 the height of air pipes, as given in [3.2.9](#), down to 600 mm on the freeboard decks and also on the decks of sunken forecastle and poop and to 380 mm on the decks of other superstructures.

3.5.3 In ships of restricted area of navigation **R2**, **R2-RSN**, **R2-RSN(4,5)**, **R3-RSN** and **R3** no side scuttle shall be fitted in a position so that its sill is below a line drawn parallel to the freeboard deck at side and having its lowest point 0,025*B* above the summer load waterline.

3.5.4 The assumed load on the hatchway covers given in [3.2.4](#) and [3.2.5](#) may be reduced for the ships of restricted areas of navigation **R2**, **R2-RSN**, **R2-RSN(4,5)**, **R3-RSN** and **R3** in conformity with 7.10.4.1, Part III "Equipment, Arrangements and Outfit" of the RS Rules/C.

3.5.5 The freeboard of ships of restricted areas of navigation, except for **R3**, may be assigned smaller than that calculated in [Section 4](#), provided that the results of integrated assessment of seaworthiness, which includes assessment of deck wetness, manoeuvrability and loss of speed at heading waves corresponding to the assigned area of ship navigation are positive.

4 ASSIGNMENT OF MINIMUM FREEBOARDS VALUES

4.1 TYPES OF SHIPS AND TABULAR FREEBOARD

4.1.1 For the purposes of freeboard calculation ships shall be divided into type A and type B.

4.1.2 Type A ships.

4.1.2.1 A type A ship is one which:

is designed to carry only liquid cargoes in bulk;

has a high integrity of the exposed deck with only small access openings to cargo compartments closed by watertight gasketed covers of steel or equivalent material; and

has low permeability of loaded cargo compartments.

4.1.2.2 A type A ship (other than oil tanker, oil tank barge, chemical tank barge and gas carrier) if over 150 m in length, to which a freeboard less than type B has been assigned, when loaded to its summer load waterline, shall be capable to withstand the flooding of any one compartment. In this case an assumed permeability shall be as follows:

0,95 for any floodable compartments and spaces (except for engine room);

0,85 for floodable engine room.

For oil tankers, oil tank barges, chemical tankers, chemical tank barges and gas carriers the requirements of Section 3, Part V "Subdivision" of the RS Rules/C shall be met.

4.1.2.3 A type A ship of unrestricted service shall be assigned a freeboard not less than that based on [Table 4.1.2.3](#).

Table 4.1.2.3

Tabular freeboard for type A ships

Length of ship, m	Freeboard, mm	Length of ship, m	Freeboard, mm	Length of ship, m	Freeboard, mm	Length of ship, m	Freeboard, mm
24	200	54	490	84	897	114	1359
25	208	55	503	85	911	115	1376
26	217	56	516	86	926	116	1392
27	225	57	530	87	940	117	1409
28	233	58	544	88	955	118	1426
29	242	59	559	89	969	119	1442
30	250	60	573	90	984	120	1459
31	258	61	587	91	999	121	1476
32	267	62	600	92	1014	122	1494
33	275	63	613	93	1029	123	1511
34	283	64	626	94	1044	124	1528
35	292	65	639	95	1059	125	1546
36	300	66	653	96	1074	126	1563
37	308	67	666	97	1089	127	1580
38	316	68	680	98	1105	128	1598
39	325	69	693	99	1120	129	1615
40	334	70	706	100	1135	130	1632
41	344	71	720	101	1151	131	1650
42	354	72	733	102	1166	132	1667
43	364	73	746	103	1181	133	1684
44	374	74	760	104	1196	134	1702
45	385	75	773	105	1212	135	1719
46	396	76	786	106	1228	136	1736
47	408	77	800	107	1244	137	1753
48	420	78	814	108	1260	138	1770
49	432	79	828	109	1276	139	1787
50	443	80	841	110	1293	140	1803
51	455	81	855	111	1309	141	1820
52	467	82	869	112	1326	142	1837
53	478	83	883	113	1342	143	1853

Load Line Rules for Sea-Going Ships (Section 4)

Length of ship, m	Freeboard, mm	Length of ship, m	Freeboard, mm	Length of ship, m	Freeboard, mm	Length of ship, m	Freeboard, mm
144	1870	200	2612	256	3048	312	3305
145	1886	201	2622	257	3054	313	3308
146	1903	202	2632	258	3060	314	3312
147	1919	203	2641	259	3066	315	3315
148	1935	204	2650	260	3072	316	3318
149	1952	205	2659	261	3078	317	3322
150	1968	206	2669	262	3084	318	3325
151	1984	207	2678	263	3089	319	3328
152	2000	208	2687	264	3095	320	3331
153	2016	209	2696	265	3101	321	3334
154	2032	210	2705	266	3106	322	3337
155	2048	211	2714	267	3112	323	3339
156	2064	212	2723	268	3117	324	3342
157	2080	213	2732	269	3123	325	3345
158	2096	214	2741	270	3128	326	3347
159	2111	215	2749	271	3133	327	3350
160	2126	216	2758	272	3138	328	3353
161	2141	217	2767	273	3143	329	3355
162	2155	218	2775	274	3148	330	3358
163	2169	219	2784	275	3153	331	3361
164	2184	220	2792	276	3158	332	3363
165	2198	221	2801	277	3163	333	3366
166	2212	222	2809	278	3167	334	3368
167	2226	223	2817	279	3172	335	3371
168	2240	224	2825	280	3176	336	3373
169	2254	225	2833	281	3181	337	3375
170	2268	226	2841	282	3185	338	3378
171	2281	227	2849	283	3189	339	3380
172	2294	228	2857	284	3194	340	3382
173	2307	229	2865	285	3198	341	3385
174	2320	230	2872	286	3202	342	3387
175	2332	231	2880	287	3207	343	3389
176	2345	232	2888	288	3211	344	3392
177	2357	233	2895	289	3215	345	3394
178	2369	234	2903	290	3220	346	3396
179	2381	235	2910	291	3224	347	3399
180	2393	236	2918	292	3228	348	3401
181	2405	237	2925	293	3233	349	3403
182	2416	238	2932	294	3237	350	3406
183	2428	239	2939	295	3241	351	3408
184	2440	240	2946	296	3246	352	3410
185	2451	241	2953	297	3250	353	3412
186	2463	242	2959	298	3254	354	3414
187	2474	243	2966	299	3258	355	3416
188	2486	244	2973	300	3262	356	3418
189	2497	245	2979	301	3266	357	3420
190	2508	246	2986	302	3270	358	3422
191	2519	247	2993	303	3274	359	3423
192	2530	248	3000	304	3278	360	3425
193	2541	249	3006	305	3281	361	3427
194	2552	250	3012	306	3285	362	3428
195	2562	251	3018	307	3288	363	3430
196	2572	252	3024	308	3292	364	3432
197	2582	253	3030	309	3295	365	3433
198	2592	254	3036	310	3298		
199	2602	255	3042	311	3302		

N o t e . Freeboards at intermediate lengths of ship shall be obtained by linear interpolation.
 Freeboards, in mm, for ships with lengths between 365 and 400 m shall be determined by the following formula:
 $16,10L - 0,02L^2 + 221$.
 Freeboards for ships with lengths 400 m and above shall be the constant value 3460 mm.

4.1.2.4 A type A ship of restricted area of navigation **R1, R2, R2-RSN, R2-RSN(4,5)** and **R3-RSN** shall be assigned a freeboard not less than that based on [Table 4.1.2.4](#).

Table 4.1.2.4

Tabular freeboards for type A ships of restricted areas of navigation R1, R2, R2-RSN, R2-RSN(4,5) and R3-RSN

Length of ship, m	Freeboard, mm	Length of ship, m	Freeboard, mm	Length of ship, m	Freeboard, mm	Length of ship, m	Freeboard, mm
24	190	69	630	114	1279	159	2031
27	210	72	670	117	1329	162	2075
30	235	75	710	120	1379	165	2118
33	260	78	750	123	1431	168	2160
36	285	81	790	126	1483	171	2201
39	310	84	830	129	1535	174	2240
42	335	87	870	132	1587	177	2287
45	365	90	910	135	1639	180	2313
48	395	93	955	138	1690	183	2348
51	425	96	1000	141	1740	186	2383
54	455	99	1045	144	1790	189	2417
57	490	102	1090	147	1839	192	2450
60	525	105	1135	150	1888	195	2482
63	560	108	1180	153	1936	198	2512
66	595	111	1229	156	1984	201	2542

Note. For ships above 201 m in length the tabular freeboard shall be assigned on the basis of the substantiation provided by the designer, including assessment of seaworthiness and deck flooding, with a wave height with 3 % probability with regard to the area of navigation.

4.1.2.5 A type A ship of restricted area of navigation **R3** shall be assigned a freeboard not less than that based on [Table 4.1.2.5](#).

Table 4.1.2.5

Tabular freeboards for type A ships of restricted area of navigation R3

Length of ship, m	Freeboard, mm	Length of ship, m	Freeboard, mm	Length of ship, m	Freeboard, mm	Length of ship, m	Freeboard, mm
24	190	57	460	90	820	123	1317
27	210	60	490	93	860	126	1369
30	230	63	520	96	900	129	1421
33	250	66	550	99	945	132	1473
36	275	69	580	102	990	135	1525
39	300	72	610	105	1035	138	1586
42	325	75	645	108	1080	141	1626
45	350	78	680	111	1125	144	1676
48	375	81	710	114	1170	147	1725
51	400	84	745	117	1215	150	1774
54	430	87	780	120	1265		

Note. Freeboards at intermediate lengths of ships shall be obtained by linear interpolation. For ships above 150 m in length the tabular freeboard shall be assigned on the basis of the substantiation provided by the designer, including assessment of seaworthiness and deck flooding, with a wave height with 3 % probability with regard to the area of navigation.

4.1.3 Type B ships.

4.1.3.1 All ships which do not come within the provisions regarding type A ships in [4.1.2.1](#) and [4.1.2.2](#) shall be considered as type B ships.

4.1.3.2 Type B ships of unrestricted service, which in position 1 have hatchways fitted with hatch covers complying with the requirements of [3.2.5](#) shall, other than [3.2.5.4](#), and unless provisions of [4.1.3.3 — 4.1.3.5](#) are applied, be assigned freeboards not less than those based on [Table 4.1.3.2](#).

Table 4.1.3.2

Tabular freeboard for type B ships

Length of ship, m	Freeboard, mm	Length of ship, m	Freeboard, mm	Length of ship, m	Freeboard, mm	Length of ship, m	Freeboard, mm
24	200	83	942	142	2151	201	3280
25	208	84	960	143	2171	202	3296
26	217	85	978	144	2190	203	3313
27	225	86	996	145	2209	204	3330
28	233	87	1015	146	2229	205	3347
29	242	88	1034	147	2250	206	3363
30	250	89	1054	148	2271	207	3380
31	258	90	1075	149	2293	208	3397
32	267	91	1096	150	2315	209	3413
33	275	92	1116	151	2334	210	3430
34	283	93	1135	152	2354	211	3445
35	292	94	1154	153	2375	212	3460
36	300	95	1172	154	2396	213	3475
37	308	96	1190	155	2418	214	3490
38	316	97	1209	156	2440	215	3505
39	325	98	1229	157	2460	216	3520
40	334	99	1250	158	2480	217	3537
41	344	100	1271	159	2500	218	3554
42	354	101	1293	160	2520	219	3570
43	364	102	1315	161	2540	220	3586
44	374	103	1337	162	2560	221	3601
45	385	104	1359	163	2580	222	3615
46	396	105	1380	164	2600	223	3630
47	408	106	1401	165	2620	224	3645
48	420	107	1421	166	2640	225	3660
49	432	108	1440	167	2660	226	3675
50	443	109	1459	168	2680	227	3690
51	455	110	1479	169	2698	228	3705
52	467	111	1500	170	2716	229	3720
53	478	112	1521	171	2735	230	3735
54	490	113	1543	172	2754	231	3750
55	503	114	1565	173	2774	232	3765
56	516	115	1587	174	2795	233	3780
57	530	116	1609	175	2815	234	3795
58	544	117	1630	176	2835	235	3808
59	559	118	1651	177	2855	236	3821
60	573	119	1671	178	2875	237	3835
61	587	120	1690	179	2895	238	3849
62	601	121	1709	180	2915	239	3864
63	615	122	1729	181	2933	240	3880
64	629	123	1750	182	2952	241	3893
65	644	124	1771	183	2970	242	3906
66	659	125	1793	184	2988	243	3920
67	674	126	1815	185	3007	244	3934
68	689	127	1837	186	3025	245	3949
69	705	128	1859	187	3044	246	3965
70	721	129	1880	188	3062	247	3978
71	738	130	1901	189	3080	248	3992
72	754	131	1921	190	3098	249	4005
73	769	132	1940	191	3116	250	4018
74	784	133	1959	192	3134	251	4032
75	800	134	1979	193	3151	252	4045
76	816	135	2000	194	3167	253	4058
77	833	136	2021	195	3185	254	4072
78	850	137	2043	196	3202	255	4085
79	868	138	2065	197	3219	256	4098
80	887	139	2087	198	3235	257	4112
81	905	140	2109	199	3249	258	4125
82	923	141	2130	200	3264	259	4139

Length of ship, m	Freeboard, mm	Length of ship, m	Freeboard, mm	Length of ship, m	Freeboard, mm	Length of ship, m	Freeboard, mm
260	4152	287	4478	314	4779	341	5065
261	4165	288	4490	315	4790	342	5075
262	4177	289	4502	316	4801	343	5086
263	4189	290	4513	317	4812	344	5097
264	4201	291	4525	318	4823	345	5108
265	4214	292	4537	319	4834	346	5119
266	4227	293	4548	320	4844	347	5130
267	4240	294	4560	321	4855	348	5140
268	4252	295	4572	322	4866	349	5150
269	4264	296	4583	323	4878	350	5160
270	4276	297	4595	324	4890	351	5170
271	4289	298	4607	325	4899	352	5180
272	4302	299	4618	326	4909	353	5190
273	4315	300	4630	327	4920	354	5200
274	4327	301	4642	328	4931	355	5210
275	4339	302	4654	329	4943	356	5220
276	4350	303	4665	330	4955	357	5230
277	4362	304	4676	331	4965	358	5240
278	4373	305	4686	332	4975	359	5250
279	4385	306	4695	333	4985	360	5260
280	4397	307	4704	334	4995	361	5268
281	4408	308	4714	335	5005	362	5276
282	4420	309	4725	336	5015	363	5285
283	4432	310	4736	337	5025	364	5294
284	4443	311	4748	338	5035	365	5303
285	4455	312	4757	339	5045		
286	4467	313	4768	340	5055		

Note. Freeboards at intermediate lengths of ship shall be obtained by linear interpolation.
 Freeboards for ships with lengths between 365 and 400 m shall be determined by the following formula: $23L - 0,0188L^2 - 587$.
 Freeboards for ships with lengths of 400 m and above shall be the constant value 5605 mm.

4.1.3.3 Type B ships of restricted areas of navigation **R1, R2, R2-RSN, R2-RSN(4,5)** and **R3-RSN** shall be assigned a freeboard not less than that based on [Table 4.1.3.3](#).

Table 4.1.3.3

Tabular freeboards for type B ships of restricted areas of navigation R1, R2, R2-RSN, R2-RSN(4,5) and R3-RSN

Length of ship, m	Freeboard, mm	Length of ship, m	Freeboard, mm	Length of ship, m	Freeboard, mm	Length of ship, m	Freeboard, mm
24	200	69	650	114	1405	159	2340
27	225	72	690	117	1470	162	2400
30	250	75	730	120	1530	165	2460
33	275	78	770	123	1590	168	2520
36	300	81	815	126	1655	171	2575
39	325	84	860	129	1720	174	2635
42	350	87	905	132	1780	177	2695
45	380	90	955	135	1840	180	2755
48	410	93	1005	138	1905	183	2810
51	440	96	1055	141	1970	186	2866
54	470	99	1110	144	2030	189	2920
57	505	102	1165	147	2090	192	2974
60	540	105	1220	150	2155	195	3025
63	575	108	1280	153	2215	198	3075
66	610	111	1340	156	2280	201	3120

Note. For ships above 201 m in length the tabular freeboard shall be assigned on the basis of the substantiation provided by the designer, including assessment of seaworthiness and deck flooding, with a wave height with 3 % probability with regard to the area of navigation.

4.1.3.4 Type B ships of restricted area of navigation **R3** shall be assigned a freeboard not less than that based on [Table 4.1.3.4](#).

Table 4.1.3.4

Tabular freeboards for type B ships of restricted area of navigation R3

Length of ship, m	Freeboard, mm	Length of ship, m	Freeboard, mm	Length of ship, m	Freeboard, mm	Length of ship, m	Freeboard, mm
24	200	57	475	90	880	123	1450
27	220	60	505	93	925	126	1515
30	240	63	535	96	975	129	1580
33	260	66	565	99	1025	132	1640
36	280	69	600	102	1075	135	1700
39	305	72	635	105	1125	138	1765
42	330	75	670	108	1175	141	1830
45	355	78	710	111	1230	144	1890
48	385	81	750	114	1285	147	1950
51	415	84	790	117	1340	150	2015
54	445	87	835	120	1390		

Note. Freeboards at intermediate lengths of ships shall be obtained by linear interpolation. For ships above 150 m in length the tabular freeboard shall be assigned on the basis of the substantiation provided by the designer, including assessment of seaworthiness and deck flooding, with a wave height with 3 % probability with regard to the area of navigation.

4.1.3.5 The assignment of a lesser freeboard than that required under [4.1.3.2](#) to any type B ship over 100 m in length is allowed, provided that, in relation to the amount of reduction granted, the following conditions are maintained:

.1 the measures provided for protection of the crew comply with the requirements of [3.3.2](#) specified for the B-60 type ships;

.2 the freeing arrangements comply with the requirements of [3.2.13](#). The area of the freeing ports in the bulwark forming wells in the freeboard deck is not to be less than 25 % of the total area of the bulwark;

.3 the hatch covers in positions 1 and 2 comply with the requirements of [3.2.5](#), other than [3.2.5.4](#) special care being given to their sealing and securing arrangements.

Hatch covers on ships intended for the carriage of bulk cargoes shall also comply with the requirements of 7.13, Part III "Equipment, Arrangements and Outfit" of the RS Rules/C;

.4 the ship, when loaded to her summer load waterline, shall remain afloat in a satisfactory condition of equilibrium after flooding of any single damaged compartment at an assumed permeability of 0,95, excluding the engine room. Such a ship, if over 150 m in length, shall withstand the flooding of the engine room, taken alone with a coefficient of permeability of 0,85.

4.1.3.6 In calculating the freeboards for type B ships which comply with the requirements of [4.1.3.5](#), the values from [Table 4.1.3.2](#) shall not be reduced by more than 60 % of the difference between the tabular values given in [4.1.3.2](#) and those given in [4.1.2.3](#) for the appropriate ship lengths.

4.1.3.7 The reduction in tabular freeboard allowed under [4.1.3.5](#) may be increased up to the total difference between the values in [Table 4.1.3.2](#) and those in [Table 4.1.2.3](#) on condition that the ship complies with the requirements of [3.4.1](#), [3.4.2](#) and [3.4.4](#), as if it was a type A ship, and further complies with the provisions of [4.1.3.5.1](#) to [4.1.3.5.4](#), except that the reference in [4.1.3.5.4](#) to the flooding of any single damaged compartment shall be treated as a reference to the flooding of any two adjacent fore and aft compartments, neither of which is the engine room.

Also any such ship of 150 m in length and over, when loaded to her summer load waterline, shall remain afloat in a satisfactory condition of equilibrium after flooding of the engine room taken alone.

4.1.3.8 Type B ships, which in position 1 have hatchways fitted with hatch covers which comply with the requirements of [3.2.4](#), other than [3.2.4.7](#) or which are fitted with securing arrangements accepted under [3.2.5.4](#), shall be assigned freeboards based upon the values given in [Table 4.1.3.2](#) increased by the values given in [Table 4.1.3.8](#).

Table 4.1.3.8

Freeboard increase over tabular freeboard for type B ships with hatch covers complying with requirements of 3.2.4 (other than 3.2.4.7)

Length of ship, m	Freeboard increase, mm	Length of ship, m	Freeboard increase, mm	Length of ship, m	Freeboard increase, mm	Length of ship, m	Freeboard increase, mm
108 and less	50	132	136	156	251	180	313
109	52	133	142	157	254	181	315
110	55	134	147	158	258	182	318
111	57	135	153	159	261	183	320
112	59	136	159	160	264	184	322
113	62	137	164	161	267	185	325
114	64	138	170	162	270	186	327
115	68	139	175	163	273	187	329
116	70	140	181	164	275	188	332
117	73	141	186	165	278	189	334
118	76	142	191	166	280	190	336
119	80	143	196	167	283	191	339
120	84	144	201	168	285	192	341
121	87	145	206	169	287	193	343
122	91	146	210	170	290	194	346
123	95	147	215	171	292	195	348
124	99	148	219	172	294	196	350
125	103	149	224	173	297	197	353
126	108	150	228	174	299	198	355
127	112	151	232	175	301	199	357
128	116	152	236	176	304	200	358
129	121	153	240	177	306		
130	126	154	244	178	308		
131	131	155	247	179	311		

Note. Freeboard increase at intermediate lengths of ship shall be obtained by linear interpolation. Freeboard increase for the ships above 200 m in length shall be determined on the basis of the substantiation provided by the designer, including assessment of seaworthiness and deck flooding, confirming that the ship's safety shall not decrease at any sea condition.

4.1.3.9 Ships of the restricted areas of navigation **RN(SCI)** and **RN(SCII)** shall be assigned by a freeboard in accordance with the requirements of 26.2.3.3, Part XVII "Distinguishing Marks and Descriptive Notations in the Class Notation Specifying Structural and Operational Particulars of Ships" of the RS Rules/C.

4.1.3.10 The minimum freeboard of ships of restricted area of navigation **R3** shall be calculated in accordance with the provisions of this Section (except for [4.4.2](#), [4.4.8.1](#), [4.4.8.4](#) and [4.4.8.8](#)).

4.1.4 Non-self-propelled ships.

A lighter, barge or other non-self-propelled ships shall be assigned a freeboard in accordance with the provisions of these Rules.

However, in the case of towed unmanned barges or pontoons the requirements of [3.3](#), [3.4.2](#) and [4.4.8](#) shall not apply. In the case of operating barges or pontoons to perform technological operations at the berth, in closed waters and ports, where onshore personnel ensuring the operation of technological equipment are present only during the work shift, the requirements of [4.4.8](#) shall not apply.

Such barges and which have on the freeboard deck only small access (not over 1,5 m²) openings closed by watertight gasketed covers of steel or other equivalent material may be assigned freeboards 25 % less than those calculated in accordance with these Rules. In this case, for the barges carrying the deck cargo, the above reduction is allowed only for the freeboard calculated as for ordinary type B ship.

Access plates, if provided by the design, shall be so designed that they have structural strength, integrity and watertightness equivalent to the deck plating. They shall be secured to the deck by closely spaced bolts.

4.1.5 Calculations of flooding of compartments.

In carrying out calculations in compliance with [4.1.2.2](#), [4.1.3.3](#), [4.1.3.4](#) and [4.1.3.5](#) the requirements for initial trim and conditions of loading, damage extent and character of flooding, as well as conditions of equilibrium after flooding specified in Section 4 of Part V "Subdivision" of the RS Rules/C shall be met.

For oil tankers, oil tank barges, chemical tankers, chemical tank barges and gas carriers the requirements of Section 3, Part V "Subdivision" of the of the RS Rules/C shall be met.

4.2 SUPERSTRUCTURES AND TRUNKS

4.2.1 Standard height of superstructure.

The standard height of a superstructure shall be as given in [Table 4.2.1](#).

Table 4.2.1

Standard height, m		
Length of ship, m	Raised quarter deck, m	All other super-structures, m
30 or less	0,9	1,8
75	1,2	1,8
125 or more	1,8	2,3

Note. The standard height of superstructure at intermediate lengths of ships shall be obtained by linear interpolation.

4.2.2 Length of superstructure.

4.2.2.1 Except as provided in [4.2.2.2](#) and [4.2.2.3](#) the length of superstructure S shall be equal to the length of these parts of the superstructure which lie within the ship length L .

4.2.2.2 Where the end bulkhead of an enclosed superstructure is of a fair convex form the length of the superstructure may be increased on the basis of replacement of convex bulkhead by an equivalent plane bulkhead. This increase ΔS shall be two-thirds of extent of the bulkhead curvature along the ship's length f . The maximum curvature which may be taken into account in determining this increase is one-half the breadth of the superstructure at the point of intersection of the superstructure bulkhead with its side b_1 ([Fig. 4.2.2.2](#)).

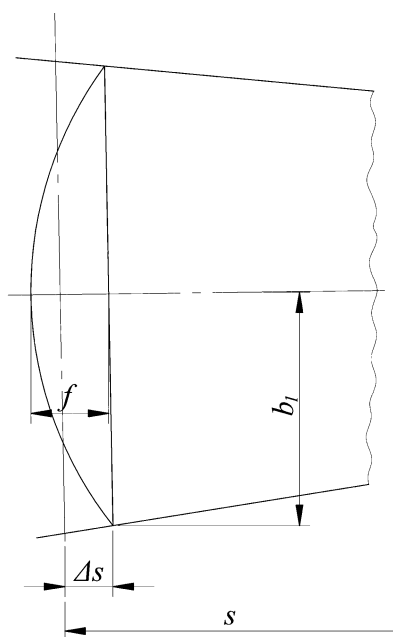

Fig. 4.2.2.2

4.2.2.3 Where a superstructure bulkhead is recessed, the effective length of the superstructure shall be reduced by an amount equal to the area of the recess related to the breadth of the superstructure at the mid-length of the recess.

Where the recess is asymmetrical about the centre line, the largest portion of the recess shall be considered as applying to both sides of the ship.

Such a recess need not be decked over.

Where a cargo hatchway, complying with the requirements of [3.2.5](#) and having a coaming height that extends above the level of the superstructure deck, is fitted in the recess of the superstructure and covering the whole area of the recess, the hatchway may be taken into

account as forming a part of the superstructure, and the effective length of the superstructure need not be reduced for recess. The hatchway coaming height measured from the superstructure deck level shall meet the requirements of [3.2.5.1](#).

Where there is an extension to a superstructure, which extension has a breadth on each side of the centre line at least 30 % of the breadth of the ship, the effective length of the superstructure may be increased in compliance with [4.2.2.2](#), considering an equivalent superstructure bulkhead in the form of a parabola. This parabola shall extend from the extension at the centre line and pass through the junction of the actual superstructure bulkhead with the sides of the extension and extend to the sides of the ship. This parabola shall be completely contained within the boundary of the superstructure and its extensions (refer to [Fig. 4.2.2.3-1](#)).

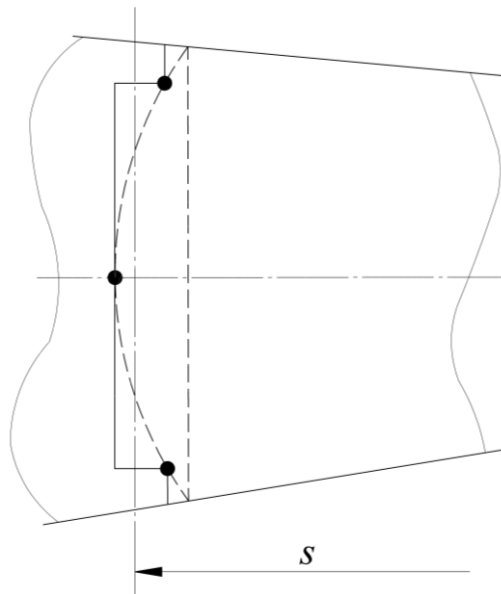

Fig. 4.2.2.3-1

Where a deckhouse adjacent to the end superstructure bulkhead is considered as the extension of it, the vertex of the above parabola may be not at the bulkhead extension, as specified above, but within the extension, on the assumption that the maximum curvature shall not exceed one-half the breadth of the superstructure at the point of intersection of the parabola with the superstructure sides (refer to [Fig. 4.2.2.3-2](#)).

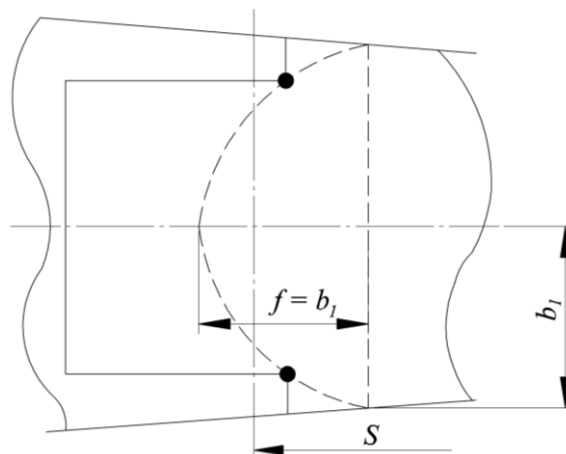

Fig. 4.2.2.3-2

4.2.2.4 The length S of a superstructure which has a sloping end bulkhead shall be determined in the following manner:

.1 when the height of the superstructure, clear of the slope, is equal to or smaller than the standard height, its length S shall be obtained as shown in [Fig. 4.2.2.4-1](#);

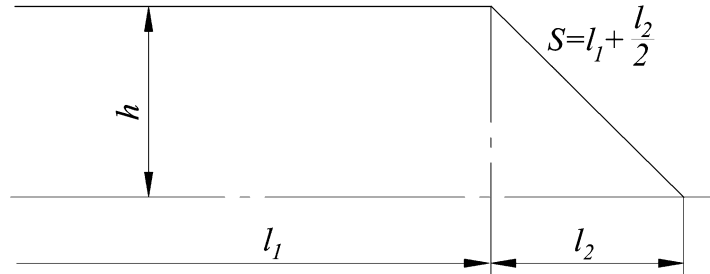

Fig. 4.2.2.4-1

.2 when the height of the superstructure is greater than the standard, its length S shall be obtained as shown in [Fig. 4.2.2.4-2](#);

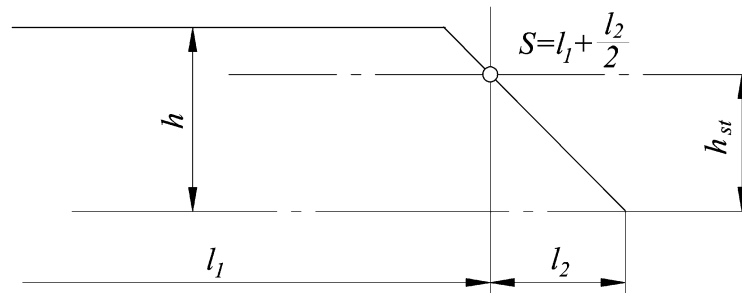

Fig. 4.2.2.4-2

.3 the foregoing shall apply only when the slope related to the base line is 15° or greater. Where the slope is less than 15° , the construction shall be treated as sheer.

4.2.3 Effective length of superstructure.

4.2.3.1 Except as provided in [4.2.3.2](#), the effective length E of an enclosed superstructure of standard height shall be its length.

4.2.3.2 Where an enclosed superstructure of standard height is set in from the sides of the ship for a distance of up to $0,04B$, the effective length shall be the length modified by the ratio of the breadth of the superstructure at the middle of its length to the breadth of the ship in the same section.

Where a superstructure is set in for a part of its length, this modification shall be applied only to the set in part.

4.2.3.3 Where the height of an enclosed superstructure is less than the standard height, the effective length shall be its length reduced in the ratio of the actual height to the standard height. Where the height of the superstructure exceeds the standard, no increase shall be made to the effective length of the superstructure.

4.2.3.4 The effective length of a raised quarter deck, if it is of a height not less than standard and is fitted with an intact front bulkhead, shall be its actual length. Where the quarter deck height is less than standard, the effective length shall be its length reduced in the ratio of the actual height of the quarter deck to its standard height.

The effective length of the raised quarter deck may be taken into account only up to a maximum of $0,6L$ from the after perpendicular. This relates also to those cases when a poop is fitted in conjunction with the raised quarter deck.

Where the bulkhead of the raised quarter deck has openings capable of being secured weathertight, such quarter deck shall be treated as a poop of less than standard height. In a ship with a superstructure which extends over the whole length of the freeboard deck, the part of the superstructure from the after perpendicular up to a maximum of $0,6L$ may be treated as a raised quarter deck. In this respect if no watertight front bulkhead is fitted at a distance of $0,6L$ from the after perpendicular, the bow end superstructure bulkhead may be considered to act as such.

4.2.3.5 Superstructures which are not enclosed shall be omitted in calculation of the effective length.

4.2.4 Trunks.

4.2.4.1 A trunk or similar structure which does not extend to the sides of the ship shall be regarded as efficient on the following conditions:

- .1 the trunk is at least as strong as a superstructure;
- .2 the hatchways are in the trunk deck, and the hatchway coamings and covers comply with the requirements of [3.2.1](#), [3.2.3](#), [3.2.4](#) and [3.2.5](#).

The sides of a trunk included in the calculation of freeboard shall be intact. Side scuttles of the nonopening type and bolted manhole covers may be allowed. The width of the trunk deck stringer provides a satisfactory gangway and sufficient lateral stiffness. Only small access openings fitted with watertight covers may be permitted in the exposed part of the freeboard deck in way of a trunk;

.3 a permanent working platform fore and aft fitted with guard rails is provided by the trunk deck, or by detached trunk decks connected to superstructures by efficient permanent gangways;

.4 ventilators are protected by the trunk and fitted with watertight covers or protected by other equivalent means;

.5 open rails are fitted on the weather parts of the freeboard deck in way of the trunk for at least half their length. If the continuous bulwark is fitted, the area of freeing ports in the lower part of the bulwark shall not be less than 33 % of its total area. The upper edge of the sheer strake shall be kept as low as practicable;

.6 the machinery casings are protected by the trunk, by a superstructure of at least standard height, or by a deckhouse of the same height and of equivalent strength;

.7 the breadth of the trunk is at least $0,6B$;

.8 where there is no superstructure, the length of the trunk is at least $0,6L$.

4.2.4.2 In the freeboard calculation continuous hatchways may be treated as a trunk provided all the conditions specified in [4.2.4.1](#) are complied with.

The trunk deck stringer referred to in [4.2.4.1.2](#) may be fitted outboard the continuous hatchway coaming and shall be of solid plate efficiently supported and stiffened providing a clear walkway of at least 450 mm in width on each side of the ship.

The stringer shall be as high above the freeboard deck as practicable.

Hatch cover securing appliances shall be accessible from the stringer or walkway.

The breadth of the trunk shall be measured between the side hatchway coamings.

4.2.4.3 Where the trunk adjoining the superstructures such as poop, bridge or forecastle is included in the freeboard calculation, the openings shall not be arranged in that part of the bulkhead which is common for the trunk and superstructure. An exemption may be made for small openings, for instance, for piping, cable, manholes with covers attached by means of bolts.

4.2.5 Standard height of trunk.

The standard height of a trunk is the standard height of a superstructure given in [Table 4.2.1](#), but not the height of a raised quarter deck.

4.2.6 Effective length of trunk.

4.2.6.1 The full length of an efficient standard height trunk multiplied by the ratio of its mean breadth to the ship's breadth shall be its effective length.

4.2.6.2 Where the height of a trunk is less than the standard height its effective length shall be reduced in the ratio of the actual to the standard height.

Where the height of a trunk exceeds the standard height, no increase shall be made to the effective length of the trunk.

In those cases where the height of hatchway coamings on the trunk deck is less than that required under [3.2.4.1](#), a reduction from the actual height of trunk shall be made, equal to the difference between the actual and the required height of coaming.

Where the actual height of the trunk is less than the standard one, the required height of coaming shall be in any case assumed equal to 600 mm.

Reduction in the actual height of trunk shall not be required in cases where only small hatches with less than standard height are fitted in the trunk deck for which dispensation from the requirement of standard coaming height may be given by the Register according to [3.2.5.1](#).

Where the cargo hatchway is treated as a trunk, the height of the hatchway coaming reduced by 600 mm or the distance between the hatchway coaming top and the stringer if fitted outboard the hatchway coaming as referred to in [4.2.4.2](#), whichever is the greater, shall be taken as the design height of the trunk.

4.3 SHEER

4.3.1 Measurement of sheer.

4.3.1.1 The sheer shall be measured from the deck at side to a line of reference drawn parallel to the keel through the sheer line amidships. Where the lowest point of the sheer is not amidships, the ordinates of the sheer curve portion below the line of reference shall be taken into account as negative ordinates.

4.3.1.2 In ships designed with a rake of keel, the sheer shall be measured in relation to a reference line drawn parallel to the design load waterline.

4.3.1.3 In flush deck ships and in ships with detached superstructures the sheer shall be measured at the freeboard deck.

4.3.1.4 In ships with topsides of unusual form in which there is a step or break in the topsides, the sheer shall be considered in relation to the moulded depth (refer to [Fig. 1.2.1-3](#)).

4.3.1.5 In ships with a superstructure which extends over the whole length of the freeboard deck, the sheer shall be measured at the superstructure deck.

Where the height of a superstructure exceeds the standard, the least difference Z between the actual and standard heights shall be added to each end ordinate. Similarly, the intermediate ordinates at distances of $1/6 L$ and $1/3 L$ from each perpendicular shall be increased by $0,444 Z$ and $0,111 Z$, respectively (refer to [Fig. 4.3.1.5](#)).

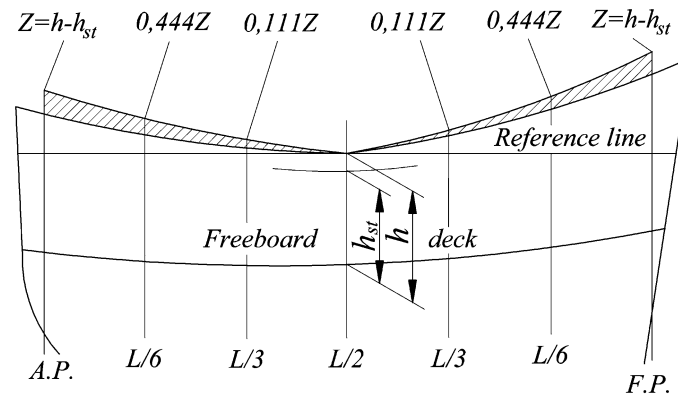

Fig. 4.3.1.5

4.3.1.6 Where the deck of an enclosed superstructure has at least the same sheer as the exposed freeboard deck, the sheer of the enclosed portion of the freeboard deck is not taken into account. The extension of the sheer of the exposed portion of the freeboard deck parallel to the sheer of the superstructure deck is taken at the sheer line in way of such superstructure (refer to [Fig. 4.3.1.6](#)).

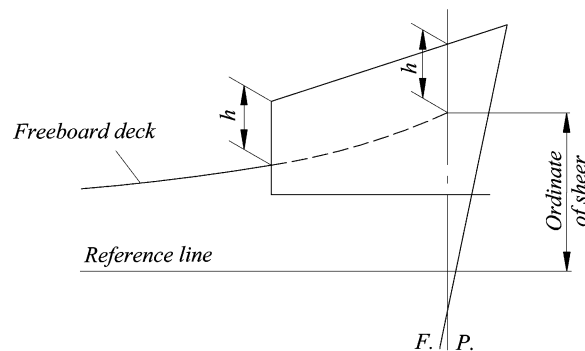

Fig. 4.3.1.6

Where the freeboard deck has no sheer, the sheer of the end superstructure and/or an excess in its height may be taken as the freeboard deck sheer, provided that such superstructure extends over not less than $0,15L$ from the perpendicular. Where the length of the end structure is smaller, the provisions of [4.3.1.7](#) apply.

4.3.1.7 Where an enclosed poop or forecastle has greater sheer than that of the freeboard deck, or is of more than standard height and also is not used [4.3.1.6](#) an addition to the sheer of the freeboard deck shall be made as provided in [4.3.4](#). For the raised quarter deck at ship's ends such sheer credit may be made only where the actual height of the raised quarter deck is greater than the standard height which is required for "other superstructures" as defined in [Table 4.2.1](#).

4.3.1.8 For an enclosed forecastle or poop superimposed on a complete superstructure extending along the whole length of the ship or for the second tier of the enclosed forecastle or poop the sheer credit as provided in [4.3.4](#) may be allowed. Z shall be taken equal to the actual height of the forecastle or poop at the forward or after perpendicular.

Where the height of the complete superstructure on which a forecastle or poop is superimposed is greater than the standard height and its excess is not taken into account as provided in [4.3.1.5](#), the sheer credit may be accounted for according to Formula ([4.3.4](#)) both for the complete superstructure and for the superimposed forecastle or poop. Z for the forward and aft part of the complete superstructure shall be determined as shown in [Fig. 4.3.1.8-1](#) and for the superimposed forecastle or poop the value Z' determined by the formula

$$Z' = Z_v + h - Z \quad (4.3.1.8-1)$$

shall be taken into account.

Where the height of the first tier of the enclosed forecastle or poop is greater than the standard height, then in calculating the sheer credit referred to in [4.3.4](#), Z shall be determined for the first tier of the forecastle or poop as shown in [Fig. 4.3.1.8-2](#), and for the second tier value Z' determined by formula

$$Z' = Z_v + h - Z \quad (4.3.1.8-2)$$

shall be taken into account.

When the length of the first tier or an enclosed poop or forecastle is greater than $0,5L$, the virtual standard parabolic curve shall commence at midships as indicated in [Fig. 4.3.1.8-1](#).

In [Figs. 4.3.1.8-1](#) and [4.3.1.8-2](#) the following designations are accepted:

Z_v = minimum difference between the actual and standard superstructure heights;

Z = end ordinate of a virtual standard parabolic curve with the uppermost point A taken through the point X . If Z is greater than $(Z_v + h)$, Z shall be equal to $(Z_v + h)$.

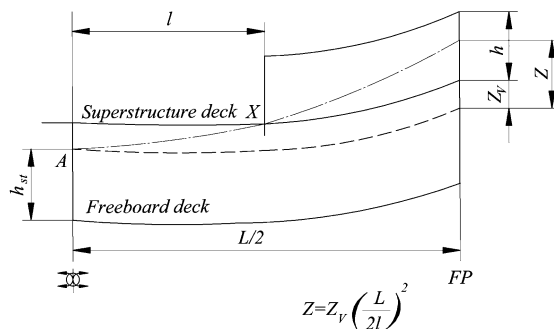

Fig. 4.3.1.8-1

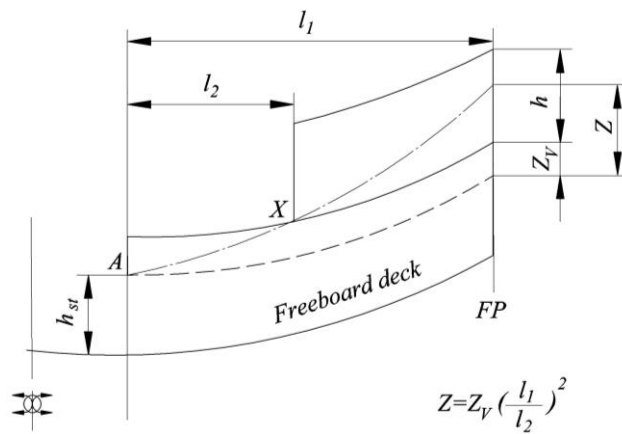

Fig. 4.3.1.8-2

4.3.2 Standard shear profile.

The ordinates of the standard shear profile are given in [Table 4.3.2](#) where the length of ship L is measured in metres.

Table 4.3.2

Station		Ordinate, mm	Factor
After half	After perpendicular	$25\left(\frac{L}{3} + 10\right)$	1
	1/6L from A.P.	$11,1\left(\frac{L}{3} + 10\right)$	3
	1/3L from A.P.	$2,8\left(\frac{L}{3} + 10\right)$	3
	Amidships	0	1
Forward half	Amidships	0	1
	1/3L from F.P.	$5,6\left(\frac{L}{3} + 10\right)$	3
	1/6L from F.P.	$22,2\left(\frac{L}{3} + 10\right)$	3
	Forward perpendicular	$50\left(\frac{L}{3} + 10\right)$	1

4.3.3 Measurement of variation from standard shear profile.

4.3.3.1 Where the shear profile differs from the standard, the four ordinates of each profile in the forward and after half shall be multiplied by the appropriate factors given in [Table 4.3.2](#). The difference between the sums of the respective products and those of the standard divided by 8 measures the deficiency or excess of shear in the forward or after halves. The arithmetical mean of the excess or deficiency in the forward and after halves measures the excess or deficiency of shear of the ship.

4.3.3.2 Where the after half of the shear profile is greater than the standard and the forward half is less than the standard, no credit shall be allowed for the excess shear in the after half and only the deficiency in shear in the forward half shall be measured.

4.3.3.3 Where the forward half of the shear profile exceeds the standard, and the after portion of the shear profile is not less than 75 % of the standard, credit shall be given for the excess shear in the forward half and the deficiency of shear in the after half. Where the after part of the shear profile is less than 50 % of the standard, no credit shall be given for the excess shear forward and only the deficiency in shear in the after half shall be measured. Where the after shear is between 50 % and 75 % of the standard, proportionate correction shall be granted for the excess shear in the forward half and full deficiency in the after half of the shear.

4.3.4 Correction for excess sheer or height of end superstructures.

Where credit is given for the excess sheer or the height of a poop or forecastle, the correction for the excess sheer or the height of the end superstructures shall be determined by the formula

$$\Delta C = ZL'/3L \tag{4.3.4}$$

- where ΔC = sheer credit, to be deducted from the deficiency or added to the excess of ship's sheer, mm;
 Z = difference between actual height of superstructure at the aft or forward perpendicular and standard height of superstructure, mm;
 L' = mean length of enclosed poop or forecastle up to a maximum length of $0,5L$, m.

Above Formula (4.3.4) represents, in relation to the ship's length, the area of a square parabola tangent to the actual sheer curve at the point of intersection of the superstructure bulkhead with the freeboard deck and intersecting the end ordinate at a point below the superstructure deck at a distance equal to the effective height of superstructure. The superstructure deck shall not be less than the accounted height of the superstructure above this curve at any point (refer to Figs. 4.3.4-1, 4.3.4-2 and 4.3.4-3).

Where the sheer credit is determined for the forward or after half of a ship separately, $0,5L$ shall be used to substitute L in the denominator in the above formula.

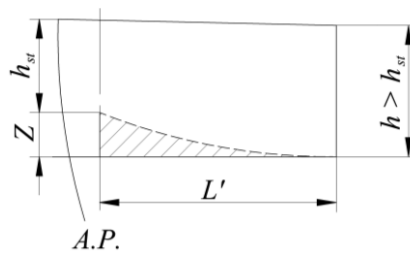

Fig. 4.3.4-1

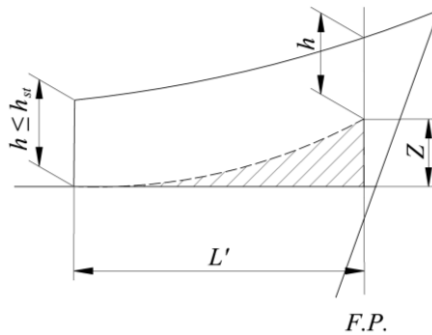

Fig. 4.3.4-2

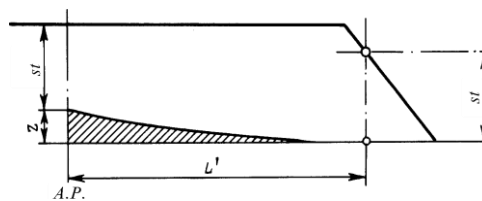

Fig. 4.3.4-3

4.4 CORRECTIONS TO TABULAR FREEBOARD

4.4.1 Determination of freeboard.

The minimum summer freeboard for type A and B ships complying with the requirements of these Rules shall be derived from [Tables 4.1.2.3](#), [4.1.2.4](#), [4.1.2.5](#), [4.1.3.2](#), [4.1.3.3](#) and [4.1.3.4](#) as modified by the corrections given below. These corrections are made for the variation from the standard of the geometrical features of a ship, the standard being covered by the values of the tabular minimum summer freeboard.

4.4.2 Correction to the freeboard for type B ships under 100 m in length.

The tabular freeboard for type B ships of between 24 and 100 m in length having enclosed superstructures with an effective length of less than 35 % of the length of the ship shall be increased by a value, mm,

$$7,5(100 - L)(0,35 - E/L) \quad (4.4.2)$$

where E = the effective length of superstructures, determined excluding the length of trunks, m.

4.4.3 Correction for block coefficient.

Where the block coefficient C_b exceeds 0,68, the tabular freeboard specified in [Tables 4.1.2.3](#), [4.1.2.4](#), [4.1.2.5](#), [4.1.3.2](#), [4.1.3.3](#) and [4.1.3.4](#) as modified by the corrections in [4.1.3.6](#), [4.1.3.7](#), [4.1.3.8](#), [4.4.2](#), if applicable, shall be multiplied by the factor

$$(C_b + 0,68)/1,36. \quad (4.4.3)$$

4.4.4 Correction for depth.

4.4.4.1 Where the depth of freeboard D exceeds $L/15$ the freeboard shall be increased by a value, mm,

$$(D - L/15)R \quad (4.4.4.1)$$

where $R = L/0,48$ at length of ship less than 120 m;
 $R = 250$ at 120 m length of ship and above.

4.4.4.2 Where D is less than $L/15$, no reduction shall be made, except in a ship with enclosed superstructures covering at least $0,6L$ amidships, with a complete trunk, or combination of detached enclosed superstructures and trunks which extend all fore and aft. For such ships the freeboard shall be reduced at the rate prescribed in [4.4.4.1](#).

Where the height of a superstructure, raised quarter deck or that of the trunk is less than their respective standard height, the reduction shall be reduced in the ratio of the actual to the standard height. Where there are several superstructures, trunks and quarter deck of different heights, their common actual height shall be the mean quantity determined on the basis of the actual and standard heights, and also lengths of the individual superstructures and trunks. The superstructures, quarter deck and trunks of greater than standard height are treated as having the standard height.

4.4.5 Correction for position of deck line.

Where the actual vertical distance measured from the top of the keel (in wooden and composite ships this distance is measured from the lower edge of the keel rabbet) to the upper edge of the deck line specified in [2.1.1](#) is greater or less than D , the difference between the depths shall be added to or deducted from the freeboard, respectively.

4.4.6 Deduction for superstructures and trunks.

4.4.6.1 Where the effective length of superstructures and trunks is $1,0L$, the deduction from the freeboard shall be 350 mm at 24 m length of ship, 860 mm at 85 m length of ship, and 1070 mm at 122 m length of ships and above; deductions at intermediate lengths of ships shall be obtained by linear interpolation.

4.4.6.2 Where the total effective length of superstructures and trunks is less than $1,0L$ the deduction shall be a percentage obtained from [Table 4.4.6.2](#).

Percentage deduction of intermediate lengths of superstructures and trunks shall be obtained by linear interpolation.

Table 4.4.6.2

Percentage of deduction for types A and B ships

Total effective length of superstructures and trunks	0	0,1L	0,2L	0,3L	0,4L	0,5L	0,6L	0,7L	0,8L	0,9L	1,0L
Percentage of deduction for all types of superstructures	0	7,0	14,0	21,0	31,0	41,0	52,0	63,0	75,3	87,7	100

4.4.6.3 For type B ships where the effective length of a forecastle is less than $0,07L$, no deduction is allowed.

4.4.7 Correction for variations from standard sheer profile.

4.4.7.1 The correction for variations from the standard sheer profile shall be the deficiency or excess of sheer (refer to [4.3.3](#) and [4.3.4](#)) multiplied by a value, mm,

$$0,75 - S/2L \tag{4.4.7.1}$$

where S = the total length of enclosed superstructures, m. The length of a trunk shall not be taken into account for calculating the total length S .

4.4.7.2 Where the sheer is less than the standard, the correction for deficiency in sheer as calculated under [4.4.7.1](#) shall be added to the freeboard.

4.4.7.3 In ships where an enclosed superstructure covers $0,1L$ before and $0,1L$ abaft amidships, the correction for excess of sheer as calculated under [4.4.7.1](#) shall be deducted from the freeboard.

In ships where no enclosed superstructure covers amidships, no deduction shall be made from the freeboard.

Where an enclosed superstructure covers less than $0,1L$ before and $0,1L$ abaft amidships, the deduction shall be obtained by linear interpolation. In this case, the deduction for excess sheer shall be reduced in the ratio of $(a + b)/0,2L$ where a and b are the distances of the fore and aft bulkheads of enclosed bridge from amidships, m.

Where the value of a or b exceeds $0,1L$, it shall be taken as equal to $0,1L$.

In those cases where the height of the enclosed superstructure or raised quarter deck is less than the respective standard height, the reduction in the freeboard shall be in the ratio of the actual height to the standard one.

In any case, the maximum deduction for excess sheer shall be at the rate of 125 mm per 100 m of the length of the ship.

4.4.8 Minimum bow height and reserve buoyancy.

4.4.8.1 The bow height defined as the vertical distance at the forward perpendicular between the waterline corresponding to the assigned summer freeboard and the maximum designed trim at the bow, and the top of the exposed deck at side shall be not less than:

$$F_b = (6075(L/100) - 1875(L/100)^2 + 200(L/100)^3) \times (2,08 + 0,609C_b - 1,603C_{wf} - 0,0129L/d_1) \quad (4.4.8.1)$$

- where F_b = the calculated minimum bow height, in mm;
- L = the ship's length, as defined in 1.2, in m;
- B = the moulded breadth, as defined in 1.2, in m;
- d_1 = 85 % of the least moulded depth, in m;
- C_b = the block coefficient, as defined in 1.2;
- C_{wf} = the waterline area coefficient forward of $L/2$;
- $C_{wf} = 2A_{wf}(BL)$;
- A_{wf} = the waterline area forward of $L/2$ at draught d_1 , in m^2 .

4.4.8.2 Where the bow height required in 4.4.8.1 is obtained by sheer, the sheer shall extend for at least $0,15L$ abaft the forward perpendicular. No point of the actual sheer shall be below the square parabola tangent at $0,15L$ from the forward perpendicular tangent to a horizontal straight line drawn through the point of the actual sheer amidships and passing through a point at the forward perpendicular, corresponding to the minimum bow height.

4.4.8.3 Where the bow height required in 4.4.8.1 is obtained by fitting a superstructure, such superstructure shall extend from the stem to a point at least $0,07L$ abaft the forward perpendicular and shall be enclosed.

4.4.8.4 When calculating the bow height, the sheer of the forecastle deck may be taken into account, even if the length of the forecastle is less than $0,15L$, but greater than $0,07L$, provided that the forecastle height is not less than one half of standard height of superstructure according to 4.2.1 between $0,07L$ and the forward perpendicular.

Where the forecastle height is less than one half of standard height of superstructure, as defined in 4.2.1, the credited bow height may be determined as follows:

.1 when the freeboard deck has sheer extending from abaft $0,15L$, by a parabolic curve having its origin at $0,15L$ abaft the forward perpendicular at a height equal to the midship depth of the ship, extended through the point of intersection of forecastle bulkhead and deck, and up to a point at the forward perpendicular not higher than the level of the forecastle deck (refer to Fig. 4.4.8.4.1). However, if the value of the height denoted h_t on Fig. 4.4.8.4.1 is smaller than the value of the height denoted h_b , then h_t may be replaced by h_b in the available bow height;

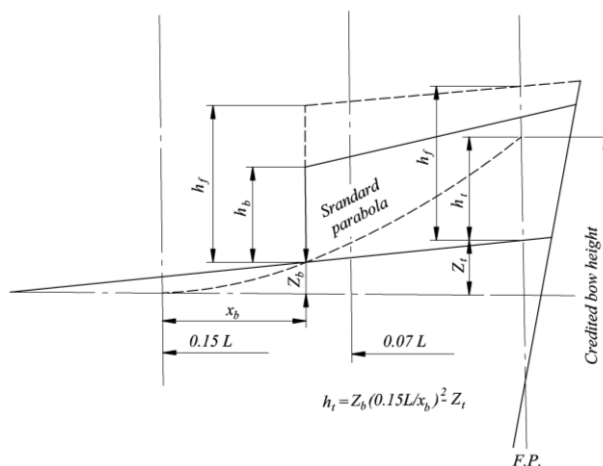

Fig. 4.4.8.4.1

.2 when the freeboard deck has sheer extending for less than $0,15L$ from a forward perpendicular or has no sheer, by a line from a point at the forecastle deck at side at $0,07L$ passing parallel to the base line to the forward perpendicular (refer to [Fig. 4.4.8.4.2](#)).

4.4.8.5 On ships to which timber freeboards are assigned minimum bow height shall be determined not from the timber summer freeboard but as specified in [4.4.8.1](#).

4.4.8.6 The bow height of ships of coastal navigation shall not be less than the value of the tabular freeboard increased by the ordinate of standard sheer at the forward perpendicular.

4.4.8.7 Freeboards for new ships which, to suit exceptional operational requirements, cannot meet the requirements of [4.4.8.1 — 4.4.8.3](#), and also for existing ships which do not comply with these requirements, shall be determined in each case on the basis of the substantiation provided by the designer, including assessment of stability, unsinkability, seaworthiness and deck flooding, confirming that the ship's safety shall not decrease at any sea condition.

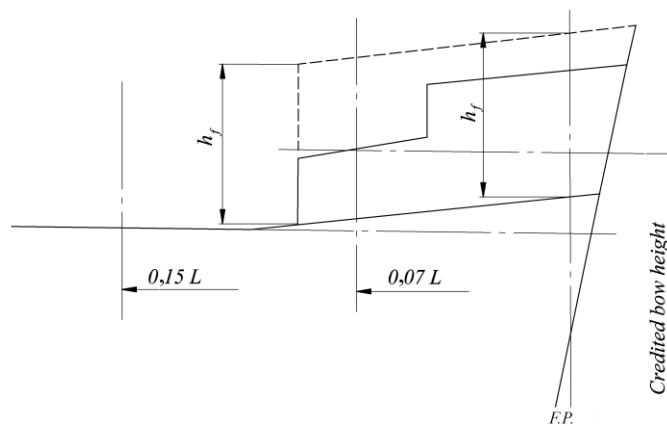

Fig. 4.4.8.4.2

4.4.8.8 All ships assigned a type B freeboard, other than oil tankers, chemical tankers and gas carriers, shall have additional reserve buoyancy in the fore end. Within the range of $0,15L$ abaft of the forward perpendicular, the sum of the projected area between the summer load waterline and the deck at side of an enclosed superstructure, in m^2 , if fitted, shall not be less than

$$(0,15F_{\min} + 4(L/3 + 10))L/1000 \quad (4.4.8.7)$$

where F_{\min} = the tabular freeboard taken from [Table 4.1.3.2](#), [4.1.3.3](#), [4.1.3.4](#) (with regard to [4.1.3.6](#) or [4.1.3.7](#), as applicable) corrected for block coefficient (refer to [4.4.3](#)) and depth (refer to [4.4.4](#)).

4.4.9 Correction for recess in the freeboard deck.

4.4.9.1 Where a recess is arranged in the freeboard deck, and this recess does not extend to the side of the ship, the freeboard calculated without regard to the recess shall be corrected for the consequent loss of buoyancy which is not included in the freeboard calculation. The correction shall be equal to the value obtained by dividing the volume of the recess (lbd_p) by the waterline area of the ship (A_w) at 85 % of the moulded depth (refer to [Fig. 4.4.9.1](#)).

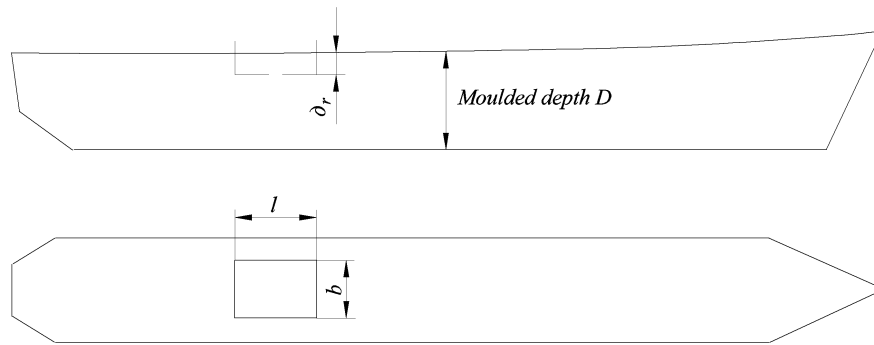

Fig. 4.4.9.1

4.4.9.2 The correction shall be a straight addition to the freeboard obtained after all other corrections have been applied, except bow height correction.

4.4.9.3 Where the freeboard, corrected for lost buoyancy as above, is greater than the minimum geometric freeboard determined on the basis of a moulded depth measured to the bottom of the recess the latter value may be used.

4.4.9.4 Recesses in a second deck, designated as the freeboard deck, may be disregarded provided all openings in the weather deck are fitted with permanent closing appliances.

4.4.9.5 Requirements of [4.4.9.1 — 4.4.9.4](#) are not intended to apply to dredgers, hopper barges or other similar types of ships with large open holds. For these types of ships the correctness value shall be determined in each case on the basis of the substantiation provided by the designer, including assessment of seaworthiness and deck flooding, confirming fulfillment of all safety measures prescribed.

4.4.9.6 Where moonpools are arranged within the ship hull in open communication with the sea, the volume of such moonpools shall not be included in calculations of hydrostatic properties. The correction shall be made to the geometric freeboard, if the moonpool has a larger cross-sectional area above the waterline at 85 % of the moulded depth than below, corresponding to the lost buoyancy. This correction for the excess portion above the waterline at 85 % of the moulded depth shall be made as prescribed for recesses in [4.4.9.1](#).

If an enclosed superstructure contains part of the moonpool, deduction shall be made from the effective length of the superstructure equal to a quotient obtained by dividing the moonpool cross-sectional area by the breadth of superstructure in the middle of the moonpool length.

4.5 DEFINITION OF MINIMUM FREEBOARD

4.5.1 Summer freeboard.

4.5.1.1 The minimum freeboard in summer shall be the freeboard derived from Tables [4.1.2.3](#), [4.1.2.4](#), [4.1.2.5](#), [4.1.3.2](#), [4.1.3.3](#) and [4.1.3.4](#) with regard to provisions of [4.1.2 — 4.1.4](#), if applicable, and corrections in [4.4.2 — 4.4.7](#), and, if applicable, [4.4.8](#) and [4.4.9](#).

4.5.1.2 The freeboard in salt water, as calculated in accordance with [4.5.1.1](#), but without the correction for the position of deck line, as provided by [4.4.5](#), shall not be less than 50 mm. For ships having in position 1 cargo hatchways with covers which do not comply with the requirements of [3.2.4.7](#), [3.2.5](#) or [3.4.3](#), the freeboard shall be not less than 150 mm.

4.5.1.3 For supply vessels the minimum height at the stern measured as a distance at aft perpendicular from the waterline, corresponding to assigned summer freeboard and maximum operating trim by the stern, to the upper edge of the open deck at ship's side shall be at least 0,005L.

4.5.2 Tropical freeboard.

4.5.2.1 The minimum freeboard in the tropical zone shall be the freeboard obtained by a deduction from the summer freeboard of 1/48 of the summer draught measured from the top of the keel to the centre of the ring of the load line mark.

4.5.2.2 The freeboard in salt water, as calculated in accordance with [4.5.2.1](#), but without the correction for the position of deck line, as provided by [4.4.5](#), shall not be less than 50 mm. For ships having in position 1 cargo hatchways with covers which do not comply with the requirements of [3.2.4.7](#), [3.2.5](#) or [3.4.3](#), the freeboard shall be not less than 150 mm.

4.5.3 Winter freeboard.

4.5.3.1 The minimum freeboard in winter shall be the freeboard obtained by an addition to the summer freeboard of 1/48 of summer draught, measured from the top of the keel to the centre of the ring of the load line mark.

4.5.3.2 When the minimum summer freeboard calculated in accordance with [4.5.1.1](#) is less than the freeboard allowed by paragraph [4.5.1.2](#), the correction for winter freeboard shall be added to the allowed minimum summer freeboard.

4.5.4 Winter North Atlantic freeboard.

The minimum freeboard for ships of not more than 100 m in length, which enter any part of the North Atlantic defined in [para 8](#) of the [Annex](#) during the winter seasonal period, shall be the winter freeboard plus 50 mm. For ships of over 100 m in length, the winter North Atlantic freeboard shall be the winter freeboard.

4.5.5 Fresh water freeboard.

4.5.5.1 The minimum freeboard in fresh water of unit density shall be obtained by deducting from the minimum freeboard in salt water the value, in cm, determined by the formula

$$\Delta/40T \quad (4.4.5.1)$$

where Δ = displacement of the ship in salt water at the summer load waterline, t;
 T = tons per 1 cm of immersion in salt water at the summer load waterline.

4.5.5.2 When the minimum summer freeboard calculated in accordance with [4.5.1.1](#) is less than the freeboard allowed by [4.5.1.2](#), the allowance for fresh water freeboard shall be deducted from the allowed minimum summer freeboard.

4.5.5.3 Where the displacement at the summer load waterline cannot be certified, the deduction shall be 1/48 of summer draught, measured from the top of the keel to the centre of the ring of the load line mark.

5 SPECIAL REQUIREMENTS FOR SHIPS WHICH ARE ASSIGNED TIMBER FREEBOARDS

5.1 CONDITIONS OF ASSIGNMENT OF TIMBER FREEBOARDS

5.1.1 Timber load line.

A timber deck cargo may be regarded as giving a ship a certain additional buoyancy and a greater degree of protection against the sea. For that reason, ships carrying a timber deck cargo may be granted a reduction of freeboard calculated according to the provisions of this Chapter and marked on the ship's side in accordance with the provisions of [2.1.3.2](#). However, in order that such special freeboard may be granted, and used, the ship shall comply with certain conditions relating to her construction which are set out in [5.1.2](#), and the stowage of the timber deck cargo shall comply with the conditions laid down in [5.1.3](#).

5.1.2 Construction of ship.

5.1.2.1 Ships shall have a forecastle of at least standard height and a length of at least $0,07L$. In addition, if the ship is less than 100 m in length, a poop of at least standard height, or a raised quarter deck with either a deckhouse or a strong steel hood of at least the same total height shall be fitted aft.

5.1.2.2 Double bottom tanks where fitted within the area extending $0,25L$ forward or abaft the midship shall have adequate watertight longitudinal subdivision.

5.1.2.3 The ship shall be fitted either with permanent bulwarks at least 1 m in height, specially stiffened on the upper edge and supported by strong bulwark stays and provided with necessary freeing ports, or with efficient rails of the same height and of specially strong construction. The bulwark stays shall be securely attached to the deck at beams or at other specially stiffened places.

5.1.3 Stowage of cargo.

5.1.3.1 Openings in the weather deck over which cargo is stowed shall be securely closed and battened down. The ventilators and air pipes shall be efficiently protected.

5.1.3.2 Timber deck cargo shall extend over at least the entire available length which is the total length of the wells between superstructures.

Where there is no limiting superstructure at the after end, the timber shall extend at least to the after end of the aftermost hatchway.

The timber deck cargo shall extend athwartships as close as possible to the ship sides, due allowance being given for obstructions, such as guard rails, bulwark stays, uprights, etc. provided any gap thus created at the side of the ship shall not exceed $0,04B$.

The timber shall be stowed as solidly as possible to at least the standard height of the superstructure, other than a raised quarter deck.

5.1.3.3 The height of the timber deck cargo allowed on a given ship shall be mentioned in the Information of ship's stability. On a ship within a seasonal winter zone in winter, the height of the deck cargo above the weather deck shall not exceed $1/3$ of the extreme breadth of the ship.

Provision shall be made for a safe margin of stability at all stages of the voyage, regard being given to additions in weight of the ship, such as those due to absorption of water by cargo and icing and to losses of weight, such as those due to consumption of fuel and stores.

5.1.3.4 The timber deck cargo shall be compactly stowed, lashed and secured. It shall not interfere in any way with the navigation and necessary work of the ship.

5.1.3.5 Uprights, when required by the nature of the timber carried, shall be of adequate strength considering the breadth of the ship.

The strength of the uprights shall not exceed the strength of the bulwark. The spacing of the uprights shall be suitable for the length and character of timber carried, but shall not exceed 3 m. Strong angles, metal sockets or equally efficient means shall be provided for securing the uprights.

5.1.3.6 Timber deck cargo shall be efficiently secured throughout its length by independent overall lashings.

The spacing of the lashings shall be determined by the maximum height of the cargo above the weather deck in the vicinity of the lashing:

- .1 for a height of 4 m and below the spacing shall be not more than 3 m;
- .2 for a height of 6 m and above the spacing shall be not more than 1,5 m;
- .3 at intermediate heights the average spacing shall be obtained by linear interpolation.

Eye plates for these lashings shall be efficiently attached to the sheer strake or to the deck stringer plate and spaced not more than 3 m apart. The distance from an end bulkhead of a superstructure to the first eye plate shall be not more than 2 m.

Eye plates and lashings shall be provided 0,6 m and 1,5 m from the ends of timber deck cargoes where there is no bulkhead.

5.1.3.7 Lashings shall be a short link chain or a flexible wire rope and a breaking load of a chain or an actual breaking strength of a wire rope shall be not less than 133 kN.

Lashings shall be fitted with sliphooks and turnbuckles which shall be accessible at all times. Wire rope lashings shall have a short length of long link chain to permit the length of lashings to be regulated.

When timber is in length less than 3,6 m, the spacing of the lashings shall be reduced or other suitable provisions made to suit the length of timber.

5.1.3.8 Shackles, stretching devices and all other ancillary components incorporated into a chain or wire rope lashing and its securings shall have a minimum ultimate load 133 kN. Each component shall be proof loaded to 55 kN.

No part shall be damaged or permanently deformed after proof loading.

5.1.3.9 The cargo shall be properly levelled up to permit passage over it. Guard rails or life lines spaced not more than 330 mm apart vertically shall be provided on each side of the timber deck cargo to a height of at least 1 m above the cargo.

Where the cargo is uneven, a safe walking surface of not less than 600 mm in width shall be fitted over the cargo and effectively secured beneath or adjacent to the lifeline.

5.1.3.10 Steering arrangements shall be effectively protected from damage by cargo and, as far as practicable, shall be readily accessible. Efficient provision shall be made for steering in the event of a breakdown in the main steering gear.

5.2 CALCULATION OF MINIMUM TIMBER FREEBOARDS FOR SHIPS OF UNRESTRICTED SERVICE

5.2.1 Summer timber freeboard.

The minimum summer timber freeboard shall be calculated in accordance with [4.1.3.1—4.1.3.4](#) and also as modified by the corrections in [4.4.2—4.4.7](#), and, if applicable, in [4.1.4](#) and [4.4.9](#). In this case, the percentages given in [Table 4.4.6.2](#) shall be replaced for those given in [Table 5.2.1](#).

Table 5.2.1

Total effective length of superstructures	0	0,1L	0,2L	0,3L	0,4L	0,5L	0,6L	0,7L	0,8L	0,9L	1,0L
Percentage of deduction for all types of superstructures	20	31	42	53	64	70	76	82	88	94	100

Note. Percentages at intermediate lengths of superstructures shall be obtained by linear interpolation.

5.2.2 Winter timber freeboard.

The minimum winter timber freeboard shall be obtained by adding to the minimum summer timber freeboard 1/36 of the summer timber draught.

5.2.3 Winter North Atlantic timber freeboard.

The minimum winter North Atlantic timber freeboard shall be the same as the winter North Atlantic freeboard prescribed in [4.5.4](#) (refer to [Fig. 5.2.3](#)).

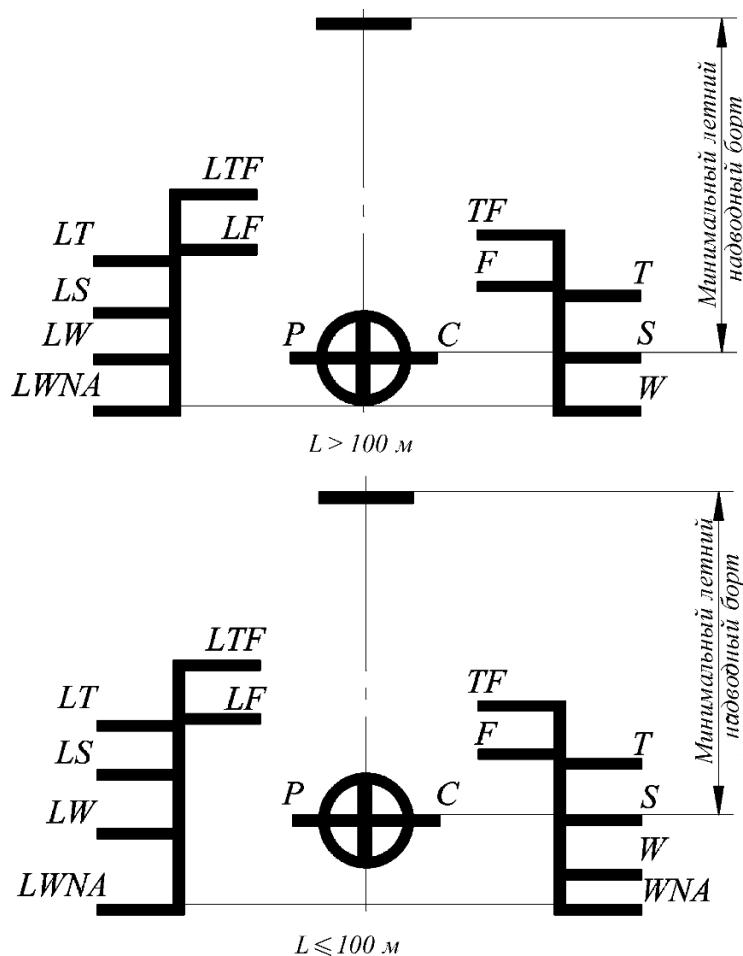

Fig. 5.2.3

5.2.4 Tropical timber freeboard.

The minimum tropical timber freeboard shall be obtained by deducting from the summer timber freeboard 1/48 of the summer timber draught.

5.2.5 Fresh water timber freeboard.

The minimum fresh water timber freeboard shall be calculated in accordance with [4.5.5.1](#) or with [4.5.5.2](#) based on the summer timber draught.

5.2.6 Timber freeboard on type B ships with reduced freeboard.

The timber freeboard on type B ships with reduced freeboard in compliance with [4.1.3.4](#) and [4.1.3.5](#) shall be assigned in conformity with the provisions of the present Chapter on the basis of the ordinary type B ship.

In this case, timber winter freeboard and/or timber winter North Atlantic freeboard shall not be assigned greater than winter freeboard calculated for type B ships having reduced freeboards.

5.3 DETERMINATION OF MINIMUM TIMBER FREEBOARD FOR SHIPS OF RESTRICTED AREA OF NAVIGATION

5.3.1 Conditions of assignment of timber freeboards.

For assigning the timber freeboard the requirements of [5.1](#) shall be met in ships.

5.3.2 Calculation of the minimum timber freeboard.

5.3.2.1 Minimum summer timber freeboard shall be calculated as follows:

.1 for ships of restricted areas of navigation **R1, R2, R2-RSN, R2-RSN(4,5)** and **R3-RSN**, except for ships of unrestricted service, passenger ships and sailing ships irrespective of their area of navigation as well as ships of restricted area of navigation **R1, R2, R2-RSN, R2-RSN(4,5)** and **R3-RSN** operating in northern seas (the Kara Sea, the Laptev Sea, the East Siberian Sea, the Chukchi Sea), in the Bering Sea and the Sea of Okhotsk, in compliance with [4.1.3.1](#) and [4.1.3.3](#);

.2 for ships of restricted area of navigation **R3**, in compliance with [4.1.3.1](#) and [4.1.3.4](#).

The corrections given in [4.4.3 — 4.4.7](#), and, if applicable, in [4.1.4](#) shall be taken into account. When determining the deduction for superstructures and trunks in accordance with [4.4.6](#), [Table 4.4.6.2](#) shall be replaced by [Table 5.2.1](#).

5.3.3 The minimum winter timber freeboard shall be obtained by adding to the minimum summer timber freeboard 1/36 of summer timber draught measured from the top of the flat keel.

5.3.4 The minimum fresh water timber freeboard shall be calculated in accordance with [4.5.5](#) based on the summer timber load waterline.

6 LOAD LINES OF MOBILE OFFSHORE DRILLING UNITS

6.1 GENERAL

6.1.1 Application.

6.1.1.1 These requirements shall apply to drilling ship's and MODU types referred to in 1.2, Part I "Classification" of the Rules for the Classification and Construction of Mobile Offshore Drilling Units¹ and intended for drilling operations for the exploration and/or exploitation of resources beneath the sea bed.

6.1.1.2 Freeboard values for MODU, in the design of which new approaches to MODU structure, supporting forces, etc. are used and to which these Rules cannot be applied, shall be assigned on the basis of the substantiation provided by the designer, including assessment of stability, unsinkability, seaworthiness, deck flooding and strength analysis.

6.1.2 Definitions and explanations.

Unless otherwise provided, definitions and explanations relating to the terminology of this Section are given in [1.2](#).

6.1.3 Scope of technical supervision and Certificates.

Scope of technical supervision and Certificates shall be in compliance with the requirements of [1.4](#).

6.1.4 Application of load lines.

Load lines shall apply to:

drilling ships;

self-elevating units in the field move (transit) condition;

semi-submersible and submersible MODUs in operating condition.

¹ Hereinafter referred to as "the MODU Rules".

6.2 MARKING

6.2.1 Deck line and load line mark.

6.2.1.1 The dimensions of the deck line shall be determined in compliance with [2.1.1](#).

6.2.1.2 The deck line shall be marked on drilling ships and self-elevating units in compliance with [2.1.1](#) and on semi-submersible and submersible units it shall be marked on the columns above the load line mark with indication in the Load Line Certificate of its distance from the lowest hull edge (working platform) of the unit.

6.2.1.3 The dimensions and configuration of the load line mark shall be in compliance with [2.1.2](#).

6.2.2 Lines to be used with the load line mark.

Lines referred to in [2.1.3](#) shall be used for drilling ships and self-elevating units. No lines are marked on semi-submersible and submersible units.

6.2.3 Mark of assigning authority. Details of marking. Marking of draughts.

6.2.3.1 The mark of the authority by whom the load lines are assigned and details of marking shall be in compliance with [2.1.3.8](#).

6.2.3.2 It is recommended that the columns of semi-submersible and submersible units above and below the draught of the unit in the operating condition be painted in different colours.

It is recommended that waterline in severe storm conditions (if such is provided in the design) and that in field move (transit) condition be indicated by a painted strip 100 mm wide. The lower edge of the strip shall be considered as a draught line. The upper and lower edges of the strip shall be punched.

Load lines, waterlines and draught marks shall be readily visible to attending personnel when performing mooring operations, during submersion and raising of the unit.

Figures of draught marks on pontoons show a draught in decimetres, those on the columns – in metres.

6.3 MINIMUM FREEBOARDS AND CONDITIONS OF THEIR ASSIGNMENT

6.3.1 Drilling ships.

6.3.1.1 Minimum freeboards of drilling ships and conditions of their assignment shall meet the requirements of Sections [2](#) and [3](#).

6.3.1.2 Where wells, such as moonpools, trunks for lowering (raising) diving bell and other wells are arranged within the hull, the volume of the wells shall be deducted from the displacement of the unit when determining the block coefficient used for freeboard calculations. An addition shall be made to the freeboard, equal to the volume of the well divided by the waterline area (having no regard to the opening area). The volume of wells or openings shall be deducted where it exceeds 0,5 % of displacement.

Otherwise, deduction from the displacement and correction to the freeboard shall not be made.

6.3.2 Self-elevating units.

6.3.2.1 Freeboard of self-elevating units and conditions of its assignment shall be in compliance with Sections [2](#) and [3](#).

6.3.2.2 The structures of legs, possessing buoyancy shall not be taken into account in determining the displacement for the purposes of freeboard calculation.

6.3.2.3 When self-elevating units are assigned the freeboard and they are expected to be manned when under tow, the requirements of [4.4.8](#) as regards the minimum bow height shall be met.

Where this requirement is difficult to achieve, adequate substantiation confirming safe conditions of the move (transit) of the unit on the predetermined route with indication of allowable wind and sea state for the field move (transit) period shall be submitted.

6.3.3 Semi-submersible units.

6.3.3.1 Freeboard of semi-submersible units is based on the value of clearance assumed in compliance with 3.2.1.2, Part II "Hull" of the MODU Rules, intact and damage stability and strength calculations.

6.3.3.2 Sill and coaming heights and closing appliances of doors, hatches, ventilator openings, air pipe heights, etc. on the working deck, as well as sanitary discharge pipes penetrating the shell and originating from the spaces which were taken into account in the arms of form stability calculations shall meet the requirements of Part III "Equipment, Arrangements and Outfit " and Part VIII "Systems and Piping" of the MODU Rules.

7 LOAD LINES OF SHIPS OF LESS THAN 24 M IN LENGTH

7.1 APPLICATION

7.1.1 The ships specified in [1.1.1.1.3](#) may be assigned the minimum freeboard for operation in allowed restricted areas of navigation **R1**, **R2** or **R3** in compliance with [7.4](#). For assigning the freeboard all the requirements specified in [7.3](#) shall be met in each ship.

7.2 MARKING

7.2.1 Deck line.

The deck line is a horizontal line 200 mm in length and 20 mm in breadth. It shall be marked on each side of the ship in compliance with [2.1.1](#).

7.2.2 Load line mark.

The load line mark shall consist of a ring 200 mm in outside diameter and 20 mm wide divided by a vertical line 20 mm in breadth passing through its centre and intersected by a horizontal line 300 mm in length and 20 mm in breadth, the upper edge of which passes through the centre of the ring.

The centre of the ring shall be placed amidships and at a distance equal to the assigned freeboard measured vertically below the upper edge of the deck line (similar to [Fig. 2.1.2](#)).

7.2.3 Lines to be used with the load line mark.

Ships have no special load lines indicating the position of load waterlines when navigating in various zones, areas and in seasonal periods as well as in fresh water and may be loaded up to the upper edge of the horizontal line passing through the centre of the ring of the load line mark.

On passenger and other ships with greater than minimum freeboard the load line mark shall be positioned as provided in [2.1.3.4—2.1.3.6](#). On passenger ships additional subdivision loadlines shall be marked together with the load line mark.

7.2.4 Load line mark designation and marking.

The load line mark shall be designated and marked in compliance with [2.1.3.8](#). In so doing, the dimensions of the letters specified in [2.1.3.8.2](#) shall be taken equal to 75 mm in height and 50 mm in width.

7.3 CONDITIONS OF ASSIGNMENT OF FREEBOARDS

7.3.1 On each ship the requirements of [Section 3](#) shall be fulfilled as well as the following requirements.

7.3.1.1 On ships of restricted areas of navigations **R2** and **R3** the height of door sills, hatchway and ventilator coamings may be reduced as follows:

- .1** the height of door sills, as given in [3.2.2.2](#), down to 230 mm;
- .2** the height of hatchway coamings, as given in [3.2.4.1](#), down to 380 mm for ships of restricted area of navigation **R2** and down to 300 mm for ships of restricted area of navigation **R3**, whatever the positions of the hatchway on a ship may be;
- .3** the height of hatchway coamings, as given in [3.2.4.1](#), down to 300 mm for fishing vessels, in position 2;
- .4** the height of door sills, as given in [3.2.6.1](#), down to 300 mm;
- .5** the height of door sills, as given in [3.2.7.3](#) – down to 230 mm;
- .6** the height of ventilator coamings, as given in [3.2.8.1](#), down to 300 mm.

7.3.1.2 The assumed loads for hatchways may be reduced by 15 % for ships of restricted area of navigation **R2** and by 30 % for ships of restricted area of navigation **R3** as against the loads specified in [3.2.4.5](#) for ships of 24 m and less in length.

7.3.1.3 In ships of restricted areas of navigation **R2** and **R3** no side scuttle shall be fitted in a position that its lower edge is below the line drawn parallel to the freeboard deck at side and having its lowest point at a distance from the waterline passing through the centre of the ring of the load line mark equal to: 300 mm for ships of restricted area of navigation **R2**, and 150 mm for ships of restricted area of navigation **R3**.

7.3.1.4 The minimum area of freeing ports in the bulwark, as given in [3.2.13.1](#), shall be at least 10 % of the area of each continuous portion of the bulwark, the provisions of [3.2.13.2 — 3.2.13.5](#) being not applied.

7.3.1.5 In ships of restricted area of navigation **R3** the discharges, as defined in [3.2.11](#), may be fitted only with one locally-controlled non-return shut-off valve.

7.3.1.6 On ships with greater than minimum freeboard windows may be fitted in the sides of wheelhouses within area I in case the portable shields are provided for each window in the front bulkhead of the wheelhouse and one for size and type of windows in the side and aft bulkheads of the wheelhouse.

7.3.1.7 Guard rails or bulwarks shall be fitted on all exposed parts of decks where people can be located.

7.4 ASSIGNMENT OF MINIMUM FREEBOARDS

7.4.1 Freeboard table.

A ship shall be assigned the freeboard not less than that based on [Table 7.4.1](#).

Table 7.4.1

Tabular freeboards				
Length of ship, m	10 and less	15	20	24
Freeboard, mm	306	340	375	400
Note. Freeboards at intermediate lengths shall be obtained by linear interpolation.				

7.4.2 Superstructures.

7.4.2.1 Standard height of superstructure.

The standard height of a superstructure is assumed to be equal to 1 m.

7.4.2.2 Effective length of superstructure.

7.4.2.2.1 Except as provided in [7.4.2.2.3](#), the effective length of an enclosed superstructure of standard height shall be its length.

7.4.2.2.2 Where the height of an enclosed superstructure is less than the standard height, the effective length shall be its length reduced in the ratio of the actual height to the standard height. Where the height of the superstructure exceeds the standard, no increase shall be made to the effective length of the superstructure.

7.4.2.2.3 Where the superstructure is a forecastle, the effective length of such superstructure may be increased in 1,5 times.

7.4.3 Corrections of tabular freeboard.

7.4.3.1 Determination of freeboard.

The freeboard of ships complying with the requirements of these Rules shall be derived from [Table 7.4.1](#) as modified by the corrections given below.

7.4.3.2 Correction for depth.

Where the depth for freeboard D exceeds $L/15$, the freeboard shall be increased, in mm, by

$$(D - L/15)L/0,48. \quad (7.4.3.2)$$

where D is less than $L/15$, no reduction shall be made.

7.4.3.3 Deduction for superstructures.

If a ship has enclosed superstructures, her freeboard determined in compliance with [7.4.3.1](#) and [7.4.3.2](#) may be reduced by

5 % with total effective length of superstructures equal to $0,2L$;

20 % with total effective length of superstructures equal to $0,5L$ and more.

Percentages of deduction for intermediate length of superstructures shall be obtained by linear interpolation.

7.4.3.4 Correction for height of coamings.

The freeboard of the ship shall be increased where the height of even one coaming of deck opening leading to the spaces which are treated as independent when subdivision of the ship is checked is less than that required by these Rules.

The increase of freeboard height shall be:

$$\Delta f = h_r - h_a \quad (7.4.3.4)$$

where $h_r - h_a =$ the greatest difference between the required and the actual heights of coamings.

7.4.3.5 Correction for angle of deck edge immersion¹.

Irrespective of the requirements of [7.4.1](#), [7.4.3.2](#), [7.4.3.3](#) and [7.4.3.4](#) the freeboard of fishing vessels shall be such as the angle of deck edge immersion is at least 12° for ships of up to 15 m in length and at least 6° for ships of 24 m in length.

The minimum permissible angle of deck edge immersion for intermediate lengths of ships shall be obtained by linear interpolation.

7.4.3.6 Minimum bow height of freeboard.

7.4.3.6.1 The minimum bow height of freeboard as defined in [4.4.8.1](#) shall be not less than that obtained by the formula, in mm,

$$56L(1 - L/500). \quad (7.4.3.6.1)$$

7.4.3.6.2 The extension of sheer or superstructure due to which the bow height of freeboard required by [7.4.3.6.1](#) is obtained shall be determined in compliance with [4.4.8.2](#) and [4.4.8.3](#).

7.4.3.6.3 Irrespective of [7.4.3.6.1](#) minimum bow height of the "protected freeboard" measured similarly to the bow height of freeboard according to [4.4.8.1](#) but to the top of the bulwark rail or visor shall be not less than 0,1L.

7.4.3.6.4 Where the required bow height of the "protected freeboard" is obtained by provision of a bulwark or visor, it shall extend from the stem to the point situated at a distance equal to at least 0,1L aft of the forward perpendicular.

7.4.3.7 Minimum stern height of freeboard.

7.4.3.7.1 Minimum stern height of freeboard obtained as specified of freeboard in [4.4.8.1](#), but at the after perpendicular at the maximum designed trim by the stern shall be equal to not less than half the bow height of freeboard as given in [7.4.3.6.1](#).

7.4.3.7.2 Where the stern height of freeboard required by [7.4.3.7.1](#) is obtained by sheer or superstructure, the extension thereof shall be not less than half that required by [4.4.8.2](#) and [4.4.8.3](#), respectively.

7.4.3.8 For ships of harbour and roadstead service the bow and stern heights of freeboard may be reduced, the bow height being not less than 0,5 m, and stern height not less than minimum midship height.

7.4.3.9 For ships having such sheer or superstructures that the requirements of [7.4.3.6](#) and [7.4.3.7](#) are fulfilled to excess, the reduction of freeboard as against that required in the present Chapter may be allowed, provided openings in the deck and superstructures are properly arranged and closed.

7.4.3.10 For ships with a recess in the freeboard deck, the freeboard calculated with due regard to [7.4.3.1](#) — [7.4.3.3](#) shall be increased by the correction calculated according to [4.4.9](#). For the ships, to which the above procedure is not applicable due to the large recess, the freeboard shall be assigned on the basis of the substantiation provided by the designer, including assessment of seaworthiness and deck flooding.

7.4.3.11 In the case of towed unmanned barges or pontoons the requirements of [3.3](#), [3.4.2](#), [7.4.3.6](#) and [7.4.3.7](#) shall not apply. In the case of operating barges or pontoons to perform technological operations at the berth, in closed waters and ports, where onshore personnel ensuring the operation of technological equipment are present only during the work shift, the requirements of [7.4.3.6](#) and [7.4.3.7](#) shall not apply.

¹ Angle of deck edge immersion is an angle measured in the midship section between the waterline and a straight line connecting the point of intersection of the waterline with the centre line and the point at the ship's side at the level of the moulded depth.

8 ASSIGNMENT OF REDUCED FREEBOARD FOR VESSELS OF DREDGING FLEET

8.1 GENERAL

8.1.1 Application.

8.1.1.1 Vessels of dredging fleet (refer to [8.1.2](#)) of 500 gross tons (GT) and above (according to the Rules for the Tonnage Measurement of Sea-Going Ships) may be assigned a reduced freeboard provided that the ship complies with the requirements of 3.8, Part IV "Stability", 3.4.13, Part V "Subdivision", 20.12, Part XI "Electrical Equipment", 4.3.2.15 and 5.3.10, Part VIII "Systems and Piping" of the RS Rules/C.

8.1.1.2 Similar ships such as (non-self-propelled) hopper barges which are capable of discharging their cargo as required under 4.3.2.15, Part VIII "Systems and Piping" of the RS Rules/C, may be treated as dredgers. The requirements for unmanned or non-self-propelled ships are given in 8.4, 4.3.2.15 and 5.3.10, Part VIII "Systems and Piping" of RS Rules/C.

8.1.2 Definitions.

Dredgings (spoil) are materials consisting of soil, sand, gravel, or rock.

Cargo means dredgings and entrained water.

8.2 LOAD LINE MARKING ON VESSELS OF DREDGING FLEET

8.2.1 Deck line and load line marks.

8.2.1.1 The dimensions of the deck line shall be determined in compliance with [2.1.1](#).

8.2.1.2 The dimensions and configuration of the load line mark shall be in compliance with [2.1.2](#).

8.2.2 Lines to be used with load line mark.

8.2.2.1 The lines which indicate the position of the load waterlines of vessels of dredging fleet (refer to [8.1.2](#)) for loading in different zones, areas and during different seasonal periods of navigation shall be horizontal lines 230 mm in length and 25 mm in breadth which extend forward of and at right angles to, a vertical line 25 mm in breadth marked at a distance 540 mm forward of the centre of the load line mark ring, as well as lines in operation condition: summer load line *S* and fresh water load line in summer *F* marked abaft and at right angles to a vertical line 25 mm in breadth marked at a distance 540 mm abaft the center of the load line mark ring (refer to [Fig. 8.2.2.1](#)).

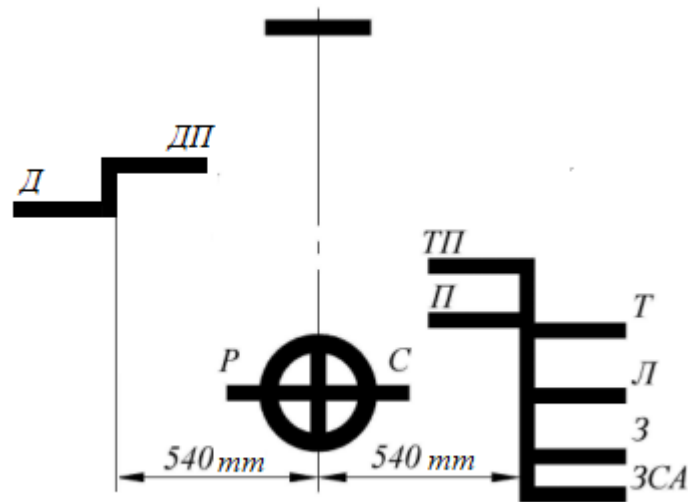

Fig. 8.2.2.1

8.2.3 Mark of assigning authority. Details of marking. Marking of draughts.

The mark of the authority by whom the load lines are assigned and details of marking shall be in compliance with [2.1.3.8](#).

8.3 REDUCED FREEBOARD FOR VESSELS OF DREDGING FLEET AND CONDITIONS OF ITS ASSIGNMENT

8.3.1 Freeboard.

8.3.1.1 The vessels of dredging fleet (refer to [8.1.2](#)) may be assigned a reduced freeboard for loading, carrying or discharging cargo. The reduced freeboard is a minimum summer freeboard calculated for a type B ship reduced by 2/3 of the minimum summer freeboard to be calculated without requirements of [4.4.8](#) taken into account.

8.3.1.2 The minimum bow height is calculated in accordance with [4.4.8](#) and reduced by the reduction as calculated in [8.3.1.1](#).

8.3.1.3 The reserve buoyancy according to [4.4.8.8](#) for the vessels of dredging fleet shall not be verified.

8.3.1.4 The minimum freeboard for the vessels of dredging fleet in fresh water shall be specified similar to [4.5.5](#).

8.3.2 Condition of assignment of freeboards.

8.3.2.1 No bulwarks shall be fitted along the ships' sides abreast of any hopper which is an open hopper.

8.3.2.2 A safe access from the fore end to the aft end of the dredger shall be provided for the protection of the crew. The safe access shall comply with the applicable requirements according to [3.3](#).

Where the access is located above the freeboard deck it shall be at least as high above the freeboard deck as the difference between the summer freeboard and the vessels of dredging fleet load line freeboard.

8.3.2.3 A suitable hopper geometry shall consist of:

.1 the height above the vessels of dredging fleet load line of the spill-out edge of the hopper, exceeding at all points the minimum bow height value calculated according to [8.3.1.2](#);

.2 freeing ports of sufficient area to ensure rapid outflow of sea water, the area of such ports being at least equivalent to the area required by [3.2.13.1](#), when hopper length and height above overflow ducts or spillways are substituted for bulwark length and height above deck;

.3 closed hopper.

8.3.2.4 For openings addressed by [3.2.10](#), [3.2.11](#) and [3.2.12](#), the terms "uppermost load line" and "summer load line" shall be replaced by the term "the vessels of dredging fleet (refer to [8.1.2](#)) load line".

The minimum coaming height of air pipes and ventilators located on the freeboard deck shall be increased by the difference between the summer freeboard and the freeboard at the the vessels of dredging fleet load line.

The coaming of ventilators and air pipes on board of the ship shall not be lower above the waterline than calculated for the coaming height of air pipes and ventilator of the freeboard deck.

8.4 SPECIAL CONSIDERATIONS FOR UNMANNED OR NON-SELF-PROPELLED SHIPS SIMILAR TO DREDGERS

8.4.1 Freeboard.

8.4.1.1 An unmanned ship similar to a vessel of dredging fleet (refer to [8.1.2](#)) is not required to meet the minimum bow height requirement as set forth in [8.3.1.2](#). In these cases, the spill-out edge shall exceed the required bow height as specified in [8.3.2.4](#).

8.4.2 Specific load line provisions.

Unmanned ships similar to the vessels of dredging fleet shall comply with the requirements of [8.3.2.2](#) except for the height of safe access requirement.

ZONES, AREAS AND SEASONAL PERIODS

1 GENERAL

1.1 The zones and areas given in the present Annex are, in general, based on the following criteria:

- .1** summer – not more than 10 % winds force 8 Beaufort (34 knots) or more;
- .2** tropical – not more than 1 % winds of force 8 Beaufort (34 knots) or more. Not more than one tropical storm in 10 years in an area of 5° longitude and 5° latitude in any one separate calendar month.

In certain special areas, for practical reasons, some degree of relaxation has been found acceptable.

A chart is attached to this Annex to illustrate the zones and areas defined below.

2 NORTHERN WINTER SEASONAL ZONES AND AREAS

2.1 NORTH ATLANTIC WINTER SEASONAL ZONES I AND II

2.1.1 The North Atlantic winter seasonal zone I lies within the meridian of longitude 50°W from the coast of Greenland to latitude 45°N, thence the parallel of latitude 45°N to longitude 15°W, thence the meridian of longitude 15°W to latitude 60°N, thence the parallel of latitude 60°N to the Greenwich Meridian, thence this meridian northwards.

Seasonal periods

Winter: 16 October to 15 April;

Summer: 16 April to 15 October.

2.1.2 The North Atlantic winter seasonal zone II lies within the meridian of longitude 68°30' W from the coast of the United States to latitude 40°N, thence the rhumb line to the point latitude 36°N, longitude 73°W, thence the parallel of latitude 36°N to longitude 25°W and thence the rhumb line to Cape Torinana.

Excluded from this zone are the North Atlantic winter seasonal zone 1, North Atlantic winter seasonal area and the Baltic Sea bounded by the parallel of latitude of the Skaw in the Skagerrak. The Shetland Islands shall be considered as being on the boundary line of the North Atlantic winter seasonal zones I and II.

Seasonal periods

Winter: 1 November to 31 March;

Summer: 1 April to 31 October.

2.2 NORTH ATLANTIC WINTER SEASONAL AREA

2.2.1 The boundary of the North Atlantic winter seasonal area is the meridian of longitude 68°30' W from the coast of the United States to latitude 40°N, thence the rhumb line to the southernmost intersection of the meridian of longitude 61°W with the coast of Canada and thence the east coasts of Canada and the United States.

Seasonal periods

- .1** for ships over 100 m in length:
Winter: 16 December to 15 February;
Summer: 16 February to 15 December;
- .2** for ships of 100 m and under in length:
Winter: 1 November to 31 March;
Summer: 1 April to 31 October.

2.3 NORTH PACIFIC WINTER SEASONAL ZONE

2.3.1 The southern boundary of the North Pacific winter seasonal zone is the parallel of latitude 50°N from the east coast of the Russian Federation to the west coast of Sakhalin, thence the west coast of Sakhalin to the southern extremity of Cape Kril'on, thence the rhumb line to Wakkanai, Hokkaido (Japan), thence the east and south coast of Hokkaido to longitude 145°E, thence the meridian of longitude 145°E to latitude 35°N, thence the parallel of latitude 35°N to longitude 150°W and thence the rhumb line to the southern extremity of Dall Island (Alaska).

Seasonal periods

Winter: 16 October to 15 April;
Summer: 16 April to 15 October.

3 SOUTHERN WINTER SEASONAL ZONE

3.1 The northern boundary of the Southern Winter Seasonal Zone is:
the rhumb line from the east coast of the American continent at Cape Tres Puntas to the point latitude 34°S, longitude 50°W, thence the parallel of latitude 34°S to longitude 16°E, thence the rhumb line to the point latitude 36°S, longitude 20°E, thence the rhumb line to the point latitude 34°S, longitude 30°E, thence along the rhumb line to the point latitude 35°30' S, longitude 118°E, and thence the rhumb line to Cape Grim on the north-west coast of Tasmania; thence along the north and east coasts of Tasmania to the southernmost point of Bruny Island, thence the rhumb line to Black Rock Point on Stewart Island, thence the rhumb line to the point latitude 47°S, longitude 170°E, thence along the rhumb line to the point latitude 33°S, longitude 170°W, and thence the parallel of latitude 33°S to the west coast of the American continent.

Seasonal periods

Winter: 16 April to 15 October;
Summer: 16 October to 15 April.

4 TROPICAL ZONE

4.1 NORTHERN BOUNDARY OF THE TROPICAL ZONE

4.1.1 The northern boundary of the tropical zone is the parallel of latitude 13°N from the east coast of the American continent to longitude 60°W, thence the rhumb line to the point latitude 10°N, longitude 58°W, thence the parallel of latitude 10°N to longitude 20°W, thence the meridian of longitude 20°W to latitude 30°N and thence the parallel of latitude 30°N to the west coast of Africa; from the east coast of Africa the parallel of latitude 8°N to longitude 70°E,

thence the meridian of longitude 70°E to latitude 13°N, thence the parallel of latitude 13°N to the west coast of India; thence the south coast of India to latitude 10°30' N on the east coast of India, thence the rhumb line to the point latitude 9°N, longitude 82°E, thence the meridian of longitude 82°E to latitude 8°N, thence the parallel of latitude 8°N to the west coast of Malaysia, thence the coast of South-East Asia, to the east coast of Viet-Nam at latitude 10°N, thence the parallel of latitude 10°N to longitude 145°E, thence the meridian of longitude 145°E to latitude 13°N and thence the parallel of latitude 13°N to the west coast of the American continent.

Saigon shall be considered as being on the boundary line of the tropical zone and the seasonal tropical area.

4.2 SOUTHERN BOUNDARY OF THE TROPICAL ZONE

4.2.1 The southern boundary of the tropical zone is the rhumb line from the Port of Santos, Brazil, to the point where the meridian of longitude 40°W intersects the Tropic of Capricorn; thence the Tropic of Capricorn to the west coast of Africa; from the east coast of Africa the parallel of latitude 20°S to the west coast of Madagascar, thence the west and north coasts of Madagascar to longitude 50°E, thence the meridian of longitude 50°E to latitude 10°E, thence the parallel of latitude 10°S to longitude 98°E, thence the rhumb line to Port Darwin, Australia, thence the coasts of Australia and Wessel Island eastwards to Cape Wessel, thence the parallel of latitude 11°S to the west side of Cape York; from the east side of Cape York the parallel of latitude 11°S to longitude 150°W, thence the rhumb line to the point latitude 26°S, longitude 75°W, and thence the rhumb line to the point latitude 32°47'S, longitude 72°W, and thence to the parallel of latitude 32°47'S to the west coast of South America.

Valparaiso and Santos shall be considered as being on the boundary line of the tropical and summer zones.

4.3 AREAS TO BE INCLUDED IN THE TROPICAL ZONE

4.3.1 The following areas shall be treated as included in the tropical zone:

.1 the Suez Canal, the Red Sea and the Gulf of Aden, from Port Said to the meridian of longitude 45°E. Aden and Berbera shall be considered as being on the boundary line of the tropical zone and the seasonal tropical area;

.2 the Persian Gulf to the meridian of longitude 59°E;

.3 the area bounded by the parallel of latitude 22°S from the east coast of Australia to the Great Barrier Reef, thence the Great Barrier Reef to latitude 11°S. The northern boundary of the area is the southern boundary of the tropical zone.

5 SEASONAL TROPICAL AREAS

5.1 IN THE NORTH ATLANTIC

5.1.1 An area bounded:

in the north by the rhumb line from Cape Catoche (Yucatan), to Cape San Antonio (Cuba), the north coast of Cuba to latitude 20°N and thence the parallel of latitude 20°N to longitude 20°W;

in the west by the coast of the American continent;

in the south and east by the northern boundary of the tropical zone.

Seasonal periods

Tropical: 1 November to 15 July;
Summer: 16 July to 31 October.

5.2 IN THE ARABIAN SEA

5.2.1 An area bounded:
in the west by the coast of Africa, the meridian of longitude 45°E in the Gulf of Aden, the coast of South Arabia and the meridian of longitude 59°E in the Gulf of Oman;
in the north and east by the coasts of Pakistan and India;
in the south by the northern boundary of the tropical zone.

Seasonal periods

Tropical: 1 September to 31 May;
Summer: 1 June to 31 August.

5.3 IN THE BAY OF BENGAL

5.3.1 The Bay of Bengal north of the northern boundary of the tropical zone.

Seasonal periods

Tropical: 1 December to 30 April;
Summer: 1 May to 30 November.

5.4 IN THE SOUTH INDIAN OCEAN

5.4.1 The following areas:
.1 an area bounded:
in the north and west by the southern boundary of the tropical zone and the east coast of Madagascar;
in the south by the parallel of latitude 20°S;
in the east by the rhumb line from the point latitude 20°S, longitude 50°E to the point latitude 15°S, longitude 51°30' E, and thence by the meridian of longitude 51°30' E to latitude 10°S.

Seasonal periods

Tropical: 1 April to 30 November;
Summer: 1 December to 31 March.

.2 an area bounded:
in the north by the southern boundary of the tropical zone;
in the east by the coast of Australia;
in the south by the parallel of latitude 15°S from longitude 51°30' E, to longitude 114°E and thence the meridian of longitude 114°E to the coast of Australia;
in the west by the meridian of longitude 51°30' E.

Seasonal periods

Tropical: 1 May to 30 November;
Summer: 1 December to 30 April.

5.5 IN THE SOUTH CHINA SEA

5.5.1 An area bounded:
in the west and north by the coasts of Viet-Nam and China from latitude 10°N to Hong Kong;
in the east by the rhumb line from Hong Kong to the Port of Sual (Luzon Island) and the west coast of the Islands of Luzon, Samar and Leyte to latitude 10°N;
in the south by parallel of latitude 10°N.
Hong Kong and Sual shall be considered as being on the boundary of the Seasonal Tropical Area and Summer Zone.

Seasonal periods

Tropical: 21 January to 30 April;
Summer: 1 May to 20 January.

5.6 IN THE NORTH PACIFIC

5.6.1 The following areas:
.1 an area bounded:
in the north by the parallel of latitude 25°N;
in the west by the meridian of longitude 160°E;
in the south by the parallel of latitude 13°N;
in the east by the meridian of longitude 130°W.

Seasonal periods

Tropical: 1 April to 31 October;
Summer: 1 November to 31 March.

.2 an area bounded:
in the north and east by the west coast of the American continent;
in the west by the meridian of longitude 123°W from the coast of the American continent to latitude 33°N and by the rhumb line from the point latitude 33°N, longitude 123°W, to the point latitude 13°N, longitude 105°W;
in the south by the parallel of latitude 13°N.

Seasonal periods

Tropical: 1 March to 30 June and 1 November to 30 November;
Summer: 1 July to 31 October and 1 December to 28/29 February.

5.7 IN THE SOUTH PACIFIC

5.7.1 The following areas:
.1 the Gulf of Carpentaria south of latitude 11°s.

Seasonal periods

Tropical: 1 April to 30 November;
Summer: 1 December to 31 March.

.2 an area bounded:
in the north and east by the southern boundary of the tropical zone;
in the south by the parallel of latitude 24°S from the east coast of Australia to longitude 154°E, thence by the meridian of longitude 154°E to the Tropic of Capricorn and

thence by the Tropic of Capricorn to longitude 150°W, thence by the meridian of longitude 150°W to latitude 20°S and thence by the parallel of latitude 20°S to the point where it intersects the southern boundary of the tropical zone;

in the west by the boundaries of the area within the Great Barrier Reef included in the tropical zone and by the east coast of Australia.

Seasonal periods

Tropical: 1 April to 30 November;
Summer: 1 December to 31 March.

6 SUMMER ZONES

6.1 The remaining areas (not stated in [2—5](#) of the present Annex) constitute the summer zones.

However, for ships of 100 m and under in length, the area bounded:
in the north and west by the east coast of the United States;
in the east by the meridian of longitude 68°30' W from the coast of the United States to latitude 40°N and thence by the rhumb line to the point latitude 36°N, longitude 73°W;
in the south by the parallel of latitude 36°N is a winter seasonal area.

Seasonal periods

Winter: 1 November to 31 March;
Summer: 1 April to 31 October.

7 ENCLOSED SEAS

7.1 BALTIC SEA

7.1.1 This sea bounded by the parallel of latitude of The Skaw in the Skagerrak is included in the summer zone.

However, for ships of 100 m and under in length, it is a winter seasonal area.

Seasonal periods

Winter: 1 November to 31 March;
Summer: 1 April to 31 October.

7.2 BLACK SEA AND SEA OF AZOV

7.2.1 The Black Sea and the Sea of Azov are included in the summer zone.
However, for ships of 100 m and under in length, the area north of latitude 44°N is a winter seasonal area.

Seasonal periods

Winter: 1 December to 28/29 February;
Summer: 1 March to 30 November.

7.3 MEDITERRANEAN

7.3.1 This sea is included in the summer zone.
However, for ships of 100 m and under in length, the area bounded:

in the north and west by the coasts of France and Spain and the meridian of longitude 3°E from the coast of Spain to latitude 40°N;

in the south by the parallel of latitude 40°N from longitude 3°E to the west coast of Sardinia;

in the east by the west and north coasts of Sardinia from latitude 40°N to longitude 9°E, thence by the meridian of longitude 9°E to the south coast of Corsica, thence by the west and north coasts of Corsica to longitude 9°E and thence by the rhumb line to Cape Sicié is a winter seasonal area.

Seasonal periods

Winter: 16 December to 15 March;

Summer: 16 March to 15 December.

7.4 SEA OF JAPAN

7.4.1 This sea south of latitude 50°N is included in the summer zone.

However, for ships of 100 m and under in length, the area between the parallel of latitude 50°N and the rhumb line from the east coast of Korea at latitude 38°N to the west coast of Hokkaido (Japan), at latitude 43°12' N is a winter seasonal area.

Seasonal periods

Winter: 1 December to 28/29 February;

Summer: 1 March to 30 November.

7.5 CASPIAN SEA

7.5.1 The Caspian Sea is included in the summer zone.

However, for ships of 100 m and under in length, it is a winter seasonal area.

Seasonal periods

Winter: 1 December to 15 March;

Summer: 16 March to 30 November.

8 WINTER NORTH ATLANTIC LOAD LINE

8.1 The part of the North Atlantic referred to in [4.5.4](#) comprises:

.1 that part of the North Atlantic winter seasonal zone II which lies between the meridians of 15°W and 50°W;

.2 the whole of the North Atlantic winter seasonal zone I, the Shetland Islands to be considered as being on the boundary.

Russian Maritime Register of Shipping

Load Line Rules for Sea-Going Ships

FAI "Russian Maritime Register of Shipping"
7, Litera A, Millionnaya Ulitsa,
St. Petersburg, 191181, Russian Federation
www.rs-class.org/en/