

# RUSSIAN MARITIME REGISTER OF SHIPPING

---

## RULES FOR THE EQUIPMENT OF SEA-GOING SHIPS PART V NAVIGATIONAL EQUIPMENT

ND No. 2-020101-144-E



Saint-Petersburg  
Edition 2021

Rules for the Equipment of Sea-Going Ships of Russian Maritime Register of Shipping have been approved in accordance with the established approval procedure and come into force on 1 January 2021.

The present edition of the Rules is based on the 2020 edition taking into account the amendments developed immediately before publication.

The unified requirements, interpretations and recommendations of the International Association of Classification Societies (IACS) and the relevant resolutions of the International Maritime Organization (IMO) have been taken into consideration.

The Rules are published in the following parts:

Part I "General";

Part II "Life-Saving Appliances";

Part III "Signal Means";

Part IV "Radio Equipment";

Part V "Navigational Equipment".

All parts of the Rules are published in electronic format in Russian and English.

## **REVISION HISTORY**

(purely editorial amendments are not included in the Revision History)

For this version, there are no amendments to be included in the Revision History.

# PART V. NAVIGATIONAL EQUIPMENT

---

## 1 GENERAL

### 1.1 APPLICATION

**1.1.1** The requirements of the present Part apply to ships constructed on or after 1 July 2002 whose navigational equipment is subject to survey by the Register, as well as to items of the above equipment intended for installation in these ships. The requirements of 5.7 of the present Part of the Rules apply to radars installed on or after 1 July 2008.

The requirements of 5.15 of the present Part apply to electronic chart display and information systems installed on or after 1 January 2009.

The requirements of the present Part apply to ships of less than 150 gross tonnage engaged in any voyages, to ships of less than 500 gross tonnage not engaged in international voyages, and to fishing vessels unless the Administration whose flag the ship is flying has decided otherwise to fit these categories of ships with navigational equipment.

**1.1.2** Ships constructed before 1 July 2002 shall comply with the requirements of Part V of the Rules in force prior to 1 July 2002<sup>1</sup>, and the requirements of 1.1.3 to 1.1.5 of the present Part.

**1.1.3** Ships constructed before 1 July 2002 shall be fitted with a radionavigation system or systems receiver complying with the requirements of 5.11 and suitable for use at all times in the ship's service area to establish and update the ship's position by automatic means, not later than the first survey after 1 July 2002.

**1.1.4** All passenger ships irrespective of size and ships of 300 gross tonnage and upwards engaged in international voyages and constructed before 1 July 2002 shall be fitted with an automatic identification system (AIS), as follows:

in the case of passenger ships, not later than 1 July 2003;

in the case of tankers<sup>2</sup>, not later than first survey of equipment and outfit on or after 1 July 2003;

in the case of ships, other than passenger ships and tankers, of 50000 gross tonnage and upwards, not later than 1 July 2004;

in the case of ships, other than passenger ships and tankers, of 300 gross tonnage and upwards but less than 50000 gross tonnage, not later than first survey of equipment and outfit on or after 1 July 2004 or 31 December 2004, whichever is earlier.

All passenger ships irrespective of size and cargo ships, including tankers, of 500 gross tonnage and upwards not engaged in international voyages and constructed before 1 July 2002 shall be fitted with an automatic identification system (AIS) not later than 1 July 2008.

**1.1.5** Passenger ships constructed before 1 July 2002 shall be fitted with a voyage data recorder (VDR) as follows:

ro-ro passenger ships not later than the first survey on or after 1 July 2002;

passenger ships other than ro-ro passenger ships not later than 1 January 2004.

Cargo ships, including tankers, engaged in inter-national voyages and constructed before 1 July 2002 shall be fitted with a simplified voyage data recorder (S-VDR) as follows:

ships of 20000 gross tonnage and upwards, during first planned docking after 1 July 2006, but not later than 1 July 2009;

ships of 3000 gross tonnage and upwards but less than 20000 gross tonnage, during first planned docking after 1 July 2007, but not later than 1 July 2010.

VDRs installed on or after 1 July 2014 shall comply with the performance standards specified in 5.20 of the present Part of the Rules.

---

<sup>1</sup>Rules for the Equipment of Sea-Going Ships, Edition 1999, pp. 211 to 264 (with regard to Notices No. 1 (2000) and No. 2 (2001)).

<sup>2</sup>The definition of a tanker is given in Part I "Classification" of Rules for the Classification and Construction of Sea-Going Ships.

VDRs are considered as installed on or after 1 July 2014 if:  
the contract for construction of a ship was signed on or after 1 July 2014; or  
the ship was constructed on or after 1 July 2014 (refer to the definition "Ships constructed" given in 1.2 of the present Part of the Rules).

For ships other than those ships prescribed above, the VDR is considered as installed on or after 1 July 2014 if:

a contractual delivery date for the VDR is 1 July 2014 or after this date; or  
the actual delivery of the VDR to the ship (when the delivery date is not stated in the contract) is 1 July 2014 or after this date.

VDRs installed before 1 July 2014 shall comply with the performance standards specified in 5.20 of Part V of the Rules in force prior to 1 January 2014.

**1.1.6** Passenger ships, including high-speed passenger craft, irrespective of their size, and cargo ships, including high-speed craft, of 300 gross tonnage and upwards engaged in international voyages constructed on or after 31 December 2008 shall be fitted with a system of long range identification and tracking of ships (LRIT).

Passenger ships, including high-speed passenger craft, irrespective of their size, and cargo ships, including high-speed craft, of 300 gross tonnage and upwards engaged in international voyages constructed before 31 December 2008 and certified for operations in sea areas A1 and A2 or in sea areas A1, A2, и A3 shall be fitted with a LRIT system equipment not later than the first survey of the radio installation after 31 December 2008.

Passenger ships, including high-speed passenger craft, irrespective of their size, and cargo ships, including high-speed craft, of 300 gross tonnage and upwards engaged in international voyages constructed before 31 December 2008 and certified for operations in sea areas A1, A2, A3 and A4 shall be fitted with a LRIT system equipment not later than the first survey of the radio installation after 1 July 2009. However, whilst these ships operate within sea areas A1, A2, A3 and A4, a LRIT system equipment shall be fitted on them not later than the first survey of the radio installation after 31 December 2008.

Ships, irrespective of the date of construction, fitted with an automatic identification system (AIS), and operated exclusively within sea area A1, shall not be required to comply with the provision of this regulation.

**1.1.7** All passenger ships irrespective of size and cargo ships of 150 gross tonnage and upwards constructed on or after 1 July 2011 shall be equipped with a bridge navigational watch alarm system (BNWAS).

**1.1.7.1** All passenger ships irrespective of size and cargo ships of 150 gross tonnage and upwards constructed before 1 July 2011 shall be equipped with a BNWAS as follows:

passenger ships, not later than the first survey after 1 July 2012;  
cargo ships of 3000 gross tonnage and upwards, not later than the first survey after 1 July 2012;  
cargo ships of 500 gross tonnage and upwards, but less than 3000 gross tonnage, not later than the first survey after 1 July 2013;  
cargo ships of 150 gross tonnage and upwards but less than 500 gross tonnage, not later than the first survey after 1 July 2014.

**1.1.7.2** All passenger ships irrespective of size and cargo ships of 150 gross tonnage and upwards constructed before 1 July 2002 shall be equipped with a BNWAS within the following terms:

passenger ships, not later than the first survey after 1 January 2016;  
cargo ships of 3000 gross tonnage and upwards, not later than the first survey of equipment and outfit after 1 January 2016;  
cargo ships of 500 gross tonnage and upwards but less than 3000 gross tonnage, not later than the first survey of equipment and outfit after 1 January 2017;  
cargo ships of 150 gross tonnage and upwards but less than 500 gross tonnage, not later than the first survey of equipment and outfit after 1 January 2018.

**1.1.8** Ships engaged on international voyages shall be fitted with an electronic chart display and information system (ECDIS) as follows:

passenger ships of 500 gross tonnage and upwards constructed on or after 1 July 2012;

tankers of 3000 gross tonnage and upwards constructed on or after 1 July 2012;

cargo ships, other than tankers, of 10 000 gross tonnage and upwards constructed on or after 1 July 2013;

cargo ships, other than tankers, of 3000 gross tonnage and upwards, but less than 10 000 gross tonnage constructed on or after 1 July 2014.

Ships engaged on international voyages shall be fitted with an ECDIS within the following terms:

passenger ships of 500 gross tonnage and upwards constructed before 1 July 2012, not later than the first survey after 30 June 2014;

tankers of 3000 gross tonnage and upwards constructed before 1 July 2012, not later than the first survey after 30 June 2015;

cargo ships, other than tankers, of 50 000 gross tonnage and upwards constructed before 1 July 2013, not later than the first survey after 30 June 2016;

cargo ships, other than tankers, of 20000 gross tonnage and upwards, but less than 50 000 gross tonnage constructed before 1 July 2013, not later than the first survey after 30 June 2017;

cargo ships, other than tankers, of 10 000 gross tonnage and upwards, but less than 20 000 gross tonnage constructed before 1 July 2013, not later than the first survey after 30 June 2018.

**1.1.9** The present Part of the Rules specifies the requirements which navigational equipment shall comply with, as well as defines the compartments in which navigational equipment shall be located and the number of navigational instruments, appliances and devices and their arrangement aboard ship.

**1.1.10** The requirements of the present Part also apply to ships under construction and in service irrespective of their dimensions, gross tonnage and date of construction whose equipment on the navigation bridge permits to ensure safe navigation by one man and for which distinguishing mark **OMBO** has been introduced in accordance with 2.2.7 of Part I "Classification" of the Rules for the Classification and Construction of Sea-Going Ships.

**1.1.11** A rigidly connected composite unit of a pushing vessel and associated pushed vessel, when designed as a dedicated and integrated tug and barge combination, shall be regarded as a single ship for the purpose of the present Part.

## 1.2 DEFINITIONS AND EXPLANATIONS

**1.2.1** Terms, definitions and explanations in relation to the general terminology of the Rules are given in Part I "Classification" of the Rules for the Classification and Construction of Sea-Going Ships.

**1.2.2** The following definitions have been adopted for the purpose of the present Part.

**A c q u i s i t i o n** is the selection of those targets requiring a tracking procedure and the initiation of their tracking.

**A c q u i s i t i o n / a c t i v a t i o n z o n e** is a zone set by operator in which the system shall automatically acquire radar targets and activate AIS targets.

**A c q u i s i t i o n o f a r a d a r t a r g e t** is a process of acquiring a target and initiating its tracking.

**A c t i v a t e d A I S t a r g e t** is a target representing the automatic or manual activation of a sleeping target for the display of additional graphically presented information.

**A c t i v a t i o n o f a n A I S t a r g e t** is activation of a sleeping AIS target for the display of additional graphical and alphanumeric information.

**A I S t a r g e t** is a target generated from an AIS message.

**A l m a n a c** is a set of parameters of the navigation system satellites on the orbit.

**A p p a r e n t w i n d** is an air movement resulting from summation/vectorial addition of true and course wind.

**A p p l i c a t i o n s p e c i f i c m e s s a g e s ( A S M )** is AIS messages in which information content is determined by the application.

**B a c k - u p o f f i c e r** means any person who is to be called if assistance is needed on the navigation bridge.

**B r i d g e w i n g s** are those parts of the bridge on both sides of the ship's wheelhouse which, in general, extend to the ship's side.

**C o n d u c t e d i n t e r f e r e n c e** means interference from equipment at the electric power supply terminals.

**C o n s i s t e n t C o m m o n R e f e r e n c e P o i n t** is a location on own ship, to which all horizontal measurements such as target range, bearing, relative course, relative speed, closest point of approach (CPA) or time to closest point of approach (TCPA) are referenced, typically the conning position of the bridge.

**C o n s i s t e n t c o m m o n r e f e r e n c e s y s t e m ( C C R S )** is a sub-system or function of an integrated navigation system (INS) for acquisition, processing, storage and distribution of data and information providing identical and obligatory reference to sub-systems and subsequent functions within an INS and to other connected equipment, if available.

**C o u r s e w i n d** is an air movement with a direction opposite to the ship's course, and speed equal to the ship's speed.

**$D_{ap}/T_{ap}$**  is distance to the closest point of approach/time to the closest point of approach. Limits are set by the radar operator related to own ship.

**D a n g e r o u s t a r g e t** is a target with a predicted CPA and TCPA that violates the values preset by the operator which is displayed by the relevant symbol (refer to column "Description" of Table 5.7.58-3).

**D a t a m e d i u m** is a means for data storage and reading using appropriate equipment.

**D e p t h** means the vertical distance from a sea level to the bottom.

**D e p t h c o n t o u r** is a contour line connecting points of equal water depths on a chart.

**D e s k** means a device combining control, monitoring, data displaying and communication facilities necessary to carry out one or several tasks at a particular workstation.

**D i s p l a y** is the electronic means presenting visual information in the letter, digital or graphical form.

**D i s p l a y b a s e** means the level of SENC information which cannot be removed from the display, consisting of information which is required at all times in all geographic areas and all circumstances. It is not intended to be sufficient for safe navigation.

**D i s p l a y i n g** means reproducing information from a navigational device, appliance or system on a display or other indicating device.

**Electronic chart display and information system (ECDIS)** means a system which with adequate backup arrangements can be accepted as complying with the up-to-date chart, by displaying selected information from a system electronic navigational chart (SENC) with positional information from navigation sensors to assist the mariner in route planning and route monitoring, and, if required, display additional navigation related information.

**Electronic navigational chart (ENC)** means the database standardized as to content, structure and format, issued for use with ECDIS on the authority of government authorized hydrographic officer. The ENC contains all the chart information necessary for safe navigation and may contain additional navigational information.

**Field of vision** is the horizontal angle within which no obstructions interfere in an observation of environment from a workstation on the navigation bridge.

**Generalized display** means overlapped reproducing on a display of information from several navigational devices or systems.

**Ground stabilization** is the display mode in which speed and course information are referred to the ground, using EPFS as reference.

**Heading** is the direction in which the bow of a ship is pointing expressed as an angular displacement from 0° to 360° from north.

**Homing** is manoeuvring to steer the ship for the course, corresponding to the bearing for the given target, and keeping it to that course.

**Integrity** is an ability of a radionavigational system to give a timely warning about the impossibility of using the system for the purpose of navigation.

**Long range identification and tracking system (LRIT)** is a system that provides for the global identification and tracking of ships on the part of Contracting Governments.

**Lookout** is one of basic duties of the watch officer carried out by sight and hearing as well as by all available equipment so as to make a full appraisal of the situation and of the risk of collision.

**Lost target** is a target representing the last valid position of a target before its data was lost. The target is displayed by a "lost target" symbol.

**Main conning position** means a workstation or the navigation bridge providing the watch officer with a commanding view and equipped with everything necessary for ship's manoeuvring and control.

**Means of data presentation** is a display or another indicator which comprises an integral part of navigational equipment system and provides for presentation of the navigation-related information.

**Navigation** is the process of deciding, executing and maintaining course and speed of the ship in relation to waters and traffic while moving from one place to another.

**Navigation bridge** means an area from which the navigation and control of the ship are exercised, including the wheelhouse and bridge wings.

**Navigational appliance** means the ship facility intended for taking decisions on one or more navigational tasks.

**Navigational device** means a device intended to execute some functions on measuring navigational parameters as well as processing, storage, transmission, displaying and recording of the data while taking decisions on the navigational tasks on board the ship.

**Navigational equipment** means the ship facilities with which the ship is equipped for taking decisions on the navigational tasks.

**Navigational instrument** means the ship's navigational device intended for manual operation while taking decisions on the navigational tasks.

**Navigator (operator)** is a specially trained person navigating and manoeuvring the ship using bridge equipment.

**Normal conditions (for OMBO ships)** means a situation when all systems and equipment on the navigation bridge operate within design limits, and environmental conditions such as weather and traffic do not cause excessive workload to the officer of the watch.



**Observation** means a determination of the ship's position by measuring several navigational parameters.

**OMBO** is a distinguishing mark for class notation, which means a control of a ship by one officer on a bridge.

**OMBO ship** means the one man bridge operated ship.

**Operational display area** is an area of the display used to graphically present chart and/or radar information, excluding the areas allocated to present other information.

**Past positions** is equally time-spaced past position marks of a tracked radar target or activated AIS target and own ship. The past positions' track may be either relative or true.

**Radar plotting** is the whole process of target detection, tracking, calculation of parameters and display of information.

**Radar target** is any object fixed or moving whose position and motion are determined by successive radar measurements of range and bearing.

**Raster chart display and information system (RCDIS)** means an operational mode of the electronic chart display and information system, which provides display of the raster navigational chart (RNC) and information on ships position from navigation sensors to assist the mariner in route planning and route monitoring, and, if required, display of additional navigation related information.

**Raster navigational chart (RNC)** means facsimile copy of a paper chart or chart folio prepared and distributed by authorized hydrographic office.

**Radiated interference** means interference radiated by the casings of equipment (apart from direct radiation of aeriels).

**Receiver autonomous integrity monitoring** is a method or an algorithm by means of which all the information acquired by the receiving part of the radio navigational system(s) is automatically processed to control the integrity of the navigation signals.

**Relative bearing** is a direction of a target position from own ship's reference location expressed as an angular displacement from own ship's heading.

**Relative course** is a direction of motion of a target relative to own ship's direction.

**Relative speed** is a speed of a target relative to own ship's speed data.

**Route monitoring** means actions on navigation control along the pre-planned route.

**Route planning** means actions performed while planning a route or making decisions on attendant navigational tasks.

**Sea stabilization** is the display mode in which speed and course information are referred to the sea, using gyro and water speed log input as reference.

**Selected target** is a target selected manually for the display of detailed alphanumeric information in a separate data display area. The target is displayed by a "selected target" symbol.

**Ships constructed** is definition given in 1.2, Part IV "Radio Equipment" of the Rules.

**Simplified voyage data recorder (S-VDR)** means an appliance, including means for interfacing with the sources of input data, for processing and encoding the data, the final recording medium; the ship's power supply source and built-in reserve power source.

**Sleeping AIS target** is a target indicating the presence and orientation of a vessel equipped with AIS in a certain location. The target is displayed by a "sleeping target" symbol. No additional information is presented until activated.

**Spare magnetic compass** is a stand-by magnetic compass to perform the function of the standard magnetic compass and interchangeable with it.

**Standard display** is the level of information that shall be shown when a chart is first displayed on ECDIS. The level of the information it provides for route planning or route monitoring may be modified by the mariner according to the mariner's needs.

**Standard magnetic compass** is a magnetic compass independent of any ship source of electrical power to determine the ship's heading and display the reading at the main steering position.

**Steady state tracking** is a tracking a target, proceeding at steady motion: after completing of the acquisition process, or without a manoeuvre of target or own ship, or without target swap or any disturbance.

**Suppressed area** is an area set by operator within which targets are not acquired.

**System Electronic Navigational Chart (SENC)** is a database, in the manufacturer's internal ECDIS format, resulting from the lossless transformation of the entire ENC contents and its updates. It is this database that is accessed by ECDIS for the display generation and other navigational functions, and is equivalent to an up-to-date paper chart. The SENC may also contain information added by the mariner and information from other sources.

**System raster navigational chart (SRNC)** means a database incorporating: RNC databases, updates and additional navigational information.

**Tanker** for the purposes of the present Part, is an oil tanker, oil tanker (>60 °C), oil tanker (>55 °C), oil recovery vessel, oil recovery vessel (>60 °C), gas carrier<sup>1</sup>, chemical tanker<sup>1</sup>, combination carrier, whose definitions are given in Part I "Classification" of the Rules for the Classification and Construction of Sea-Going Ships.

**Target bearing** is the direction of a target from own ship's consistent common reference point measured as an angular displacement from 0° to 180° on starboard or portside, between the fore part of the longitudinal axis of the ship and the target direction.

**Target swap** is a situation in which the incoming radar data for a tracked target becomes incorrectly associated with another tracked target or a non-tracked radar echo.

**Target's motion trend** is the indication on a display with permissible errors of a linear extrapolation into the future of a target's motion in a minute after tracking initiation.

**Target's predicted motion** is the indication on a display of a linear extrapolation into the future of a target's motion based on measurements of the target's range and bearing in the recent past.

**Time of image reconstruction on the ECDIS display** means the time interval between moments of image reconstruction starting and new image generation completing.

**Time of image regeneration on the ECDIS display** means the time interval between moments of operator's appropriate actions executing and subsequent reconstruction completing.

**Totally enclosed bridge** is a bridge without bridge wings, with the breadth of the wheelhouse equal to or exceeding the ship's breadth.

**Tracking** is the process of observing the sequential changes in the position of a target to establish the parameters of its motion.

**Transmitting heading device** is an electronic means to receive heading information from the sensor and to transmit it to other navigational equipment.

**Trial manoeuvre** is the facility used to assist the operator to perform a proposed manoeuvre for navigation and collision avoidance purposes, by displaying the predicted future status of all tracked and AIS targets as a result of own ship's simulated manoeuvres.

**True bearing** is a direction of a target from own ship's reference location or from another target's position expressed as an angular displacement from true north.

**True course** is a direction of motion relative to ground or to sea, of a target expressed as an angular displacement from north.

**True motion** is combination of true course and true speed.

**True speed** is a speed of a target relative to ground or to sea.

**True wind** is an actual horizontal air movement over the sea surface which can be detected by recording devices.

**Trunk for log and/or echo sounder** is a special watertight compartment in the ship's hull below waterline provided with a watertight closure.

---

<sup>1</sup> This definition is applicable in the case of carriage of flammable liquid cargo by the ships.

**Voyage data recorder (VDR)** means an appliance intended for collecting, recording and storage of voyage data and comprising: means for information encoding and recording, means for interfacing to data sensors, final recording medium placed in its capsule, ship's source of electrical power supply and built-in reserve power source.

**Watch alarm** means an alarm that is transferred from the navigation bridge to the master and the back-up officer in case of the watch officer unfitness.

**Watch officer** is any person who is responsible for safe navigation, navigates, manoeuvres the ship and operates bridge equipment until he is relieved by another officer.

**Watch officer fitness** means an ability of any person keeping watch to perform his duties unassisted and to the full extent, and timely respond to all alarms/warnings and fitness verification signals as well.

**Waypoint** means a point on the pre-set ship's track whose symbol and co-ordinates are entered in a control program.

**Wheelhouse** is the endorsed area of the navigation bridge where the main conning position of the ship is located.

**Workstation** means a position on the navigation bridge having the relevant equipment where the watch officer as well as the master or pilot carry out one or several tasks.

**1.2.3** Definitions relating to the Recommendations on Bridge Design, Equipment Arrangement and Procedures are set forth in Appendix to the present Part of the Rules.

### 1.3 SCOPE OF SURVEY

**1.3.1** General provisions regarding the procedure of survey of navigational equipment, as well as the requirements for technical documentation to be submitted to the Register for consideration, and indication of documents on navigational equipment issued by the Register are specified in General Regulations for the Classification and Other Activity, Part II "Technical Documentation" of the Rules for Technical Supervision during Construction of Ships and Manufacture of Materials and Products for Ships and Part I "Survey Regulations" of the Rules.

**1.3.2** The Register carries out technical supervision during design and survey during manufacture, installation and operation of the following shipboard navigational equipment:

- .1 standard, spare and lifeboat magnetic compasses, including those with distant reading systems;
- .2 transmitting heading devices;
- .3 gyrocompasses;
- .4 gyromagnetic compasses and gyroazimuths;
- .5 logs (water speed, bottom speed);
- .6 echo sounders;
- .7 rate-of-turn indicators;
- .8 radars, including those with electronic plotting aids (EPA), automatic tracking aids (ATA) and automatic radar plotting aids (ARPA);
- .9 radar reflectors;
- .10 radiobeacon stations;
- .11 various radionavigation system receivers;
- .12 ship control desks;
- .13 integrated navigation systems;
- .14 unified ship's timing systems;
- .15 electronic chart display and information systems (ECDIS) and their electronic duplication means;
- .16 ship's heading control systems;
- .17 ship's track control systems;
- .18 apparatus of automatic identification system (AAIS);
- .19 bridge navigational watch alarm system (BNWAS);
- .20 outside sound signal reception system;
- .21 voyage data recorders/simplified voyage data recorders;
- .22 system of long range identification and tracking of ships (LRIT);
- .23 weather stations;
- .24 analog-digital signal converters;
- .25 digital signal multipliers;
- .26 electronic inclinometer;
- .27 radar ice display;
- .28 other not listed above navigational systems, equipment and devices, upon the Register request.

The navigational appliances and devices indicated in items 21 to 28 of Table 2.2.1 are subject to the Register survey only in the form of checking their availability on board the ship.

**1.3.3** Technical supervision by the Register during design and survey during manufacture of shipborne navigational equipment covers the following:

- .1 review of technical documentation for navigational equipment;
- .2 review of the programme and procedure of the prototype model factory tests;
- .3 survey during the prototype model factory tests;
- .4 review of the programme and procedure of the prototype model shipboard tests;
- .5 survey during the prototype model shipboard tests;
- .6 review of technical documentation reflecting changes made based on results of factory and shipboard tests of the prototype model;

.7 survey during manufacture of series of navigational equipment.

**1.3.4** The technical documentation for navigational equipment submitted to the Register for review shall contain (where applicable) the following information:

- .1 technical description;
- .2 block diagram;
- .3 general view drawing;
- .4 operation manual;
- .5 installation manual;
- .6 list of spare parts.

Together with the technical documentation the records of the tests performed as well as the available certificates may be submitted. Depending on a type of the radio equipment, the Register may require the additional technical documentation to be submitted. Upon review of the technical documentation submitted, the applicant shall agree and submit for approval the test program.

The prototype model of navigational equipment developed and manufactured in compliance with the technical documentation shall be subjected to factory and shipboard tests for the purpose of verifying the performance characteristics being in compliance with the Register Rules and technical documentation. The tests shall be carried out under the Register technical supervision.

On completion of factory and shipboard tests of the navigational equipment prototype model, the test reports and records as well as photos of new navigational equipment shall be submitted to the Register. All these materials are kept at the Register and they serve as the basis for concluding whether this navigational equipment may be applied on ships with the relevant documents being issued.

**1.3.5** After installation on board ship, all navigational equipment shall be properly adjusted and subject to survey, tests in operation and electromagnetic compatibility tests.

After installation of new navigational equipment or renewal of outdated ( which became inoperative and is not subject to repair) on ships in service the technical design of the installation and working drawings shall be submitted to the Register prior to commencement of survey of this equipment.

Upon approval of the technical design and working drawings the navigational equipment installed shall be surveyed on board ship and tested in operation.

On ships under construction tests of navigational equipment under operating conditions and electromagnetic compatibility tests of all radio and navigational equipment, fitted on the bridge or in the vicinity of the bridge, are conducted during mooring and sea trials in compliance with the programs approved by the Register.

**1.3.6** The approval of equipment developed without survey by the Register may be given after detailed review of technical documentation (description, diagrams, test records, etc.) and carrying out the appropriate tests in compliance with the requirements of the present Part.

**1.3.7 Technical documentation for OMBO ships.**

**1.3.7.1** Before the beginning of the construction or conversion of a ship the following technical documentation shall be submitted to the Register for review:

- .1 deck plan of the navigation bridge indicating the arrangement of the relevant equipment.

The plans shall show the dimensions of the wheelhouse as well as the arrangement, sizes and angles of inclination of the windows and spacing between them, the bridge wings and entrances to the wheelhouse;

- .2 arrangement plan of consoles, front panels and their configuration with indication of all instruments and devices;

- .3 drawing of workstations with indication of the equipment located there.

The drawings shall show the blind zones as well as horizontal and vertical field of vision from the workstation. The vertical field of vision shall be shown for the ship in ballast;

- .4 arrangement plan of the equipment which is functionally connected with the navigation bridge but located outside its boundaries;

- .5 arrangement plan of aerials and radio equipment;

- .6 drawing of the navigation bridge communication system with accommodation and service spaces and of a signaling system;

- .7 drawing of power supply of the whole equipment located on navigation bridge;
  - .8 drawing of the system used for calling the back-up officer and/or ship's master (may be replaced by a bridge navigational watch alarm system (BNWAS) with a function of urgent calling the back-up officer and/or ship's master);
  - .9 specifications of the integrated navigation system;
  - .10 drawing of the BNWAS;
  - .11 list of equipment installed on the navigation bridge with indication of the information regarding the manufacturer, model type, valid Register's Type Approval Certificate (if the type approval is required by the Nomenclature of Items of the Register Technical Supervision).
- 1.3.8** Every ship shall be permanently provided with the following technical documentation:
- .1 description and maintenance instructions for each kind of navigational equipment in Russian or in English;
  - .2 circuit diagrams of the navigational equipment, corrected in accordance with all alterations made in the process of operation;
  - .3 the document issued by a firm authorized by the manufacturer or recognized by the Register confirming completion of the radar installation in full accordance with the manufacturer's technical documentation and design approved by the Register. This document shall contain the following information:
    - about blind sectors and possible performance limitations;
    - about radar means of interface with other systems and about displacement of the consistent common reference point.

## **2 NAVIGATIONAL EQUIPMENT OF SELF-PROPELLED SEA-GOING SHIPS**

### **2.1 DIVISION OF SHIPS INTO GROUPS**

**2.1.1** For the purpose of the present Part all self-propelled ships are grouped according to their gross tonnage (refer to Table 2.2.1).

2.2 LIST OF NAVIGATIONAL EQUIPMENT

2.2.1 Navigational devices, appliances and instruments which shall be installed on board ship or with which the ship shall be supplied shall be provided depending on the gross tonnage of the ship, area of navigation and ship's purpose in accordance with Table 2.2.1.

The definitions of the areas of navigation are given in 1.2, Part I "Survey Regulations".

Table 2.2.1

Nos.	Navigational equipment	Number of items for ships of gross tonnage							Remarks
		< 150 <sup>1</sup>	≥ 150 <sup>1</sup>	≥ 300	≥ 500	≥ 3000	≥ 10000	≥ 50000	
1	Standard magnetic compass <sup>2</sup>	1	1	1	1	1	1	1	The compass shall be complete with a bearing device independent of any power supply to take bearings over an arc of the horizon of 360°
2	Spare magnetic compass	—	1	1	1	1	1	1	Shall be interchangeable with the standard magnetic compass. Not required where complete doubling of standard magnetic compass is provided (refer to Note 6)
3	Radionavigation system/systems receiver <sup>3</sup>	1	1	1	1	1	1	1	The ship's position shall be established by automatic means
4	Radar <sup>4</sup> with	—	—	1	1	2	2	2	One radar shall be a 9 GHz radar (wave length of 3 cm)
	.1 electronic plotting aid (EPA)	—	—	1	—	—	—	—	—
	.2 automatic tracking aid (ATA)	—	—	—	1	2	1	1	—
	.3 automatic radar plotting aid (ARPA)	—	—	—	—	—	1	1	—
5	Simplified voyage data recorder (S-VDR)	—	—	—	—	1 <sup>5</sup>	1 <sup>5</sup>	1 <sup>5</sup>	Not required on ships not engaged in international voyages
6	Transmitting heading device <sup>7</sup>	—	—	1 <sup>6</sup>	—	—	—	—	—
7	Gyrocompass <sup>8</sup>	—	—	—	1	1	1	1	The gyrocompass shall be complete with a repeater (repeaters) to take bearings over an arc of horizon of 360° <sup>9</sup>
8	Echo sounder <sup>10</sup>	—	—	1	1	1	1	1	—
9	Speed and distance measuring device through the water (log) <sup>10</sup>	—	—	1	1	1	1	1	Shall measure speed and the distance run through the water
10	Speed and distance measuring device over the ground (absolute log) <sup>10</sup>	—	—	—	—	—	—	1	Shall measure speed and the distance run over the ground in the forward and athwartship directions
11	Automatic identifications system (AIS)	—	—	1 <sup>11</sup>	1	1	1	1	—
12	Heading or track control system	—	—	—	—	—	1	1	—
13	Rate of turn indicator	—	—	—	—	—	—	1	—
14	Sound reception system	1	1	1	1	1	1	1	Required in ships with totally enclosed navigation bridge and OMBO ships
15	Voyage data recorder (VDR) <sup>12</sup>	—	—	—	—	1	1	1	Not required on ships not engaged in international voyages
16	Electronic chart display and information system (ECDIS) <sup>14</sup>	—	—	—	1	1	1	1	Back-up arrangements shall be provided in accordance with 5.15.90 to 5.15.107
17	Equipment of long range identification and tracking system (LRIT system) <sup>14</sup>	—	—	1	1	1	1	1	Not required on ships not engaged in international voyages. Passenger ships engaged in international voyages shall be fitted with this equipment irrespective of size
18	Bridge navigational watch alarm system (BNWAS)	—	1	1	1	1	1	1	Ships shall be fitted with the BNWAS within the time period specified in 1.1.7
19	Indicators of:								The indicators shall be readable from the conning position
	.1 rudder angle	—	—	—	1	1	1	1	—
	.2 propeller revolutions, the force and direction of thrust	—	—	—	1	1	1	1	—
	.3 pitch and operational mode of controllable pitch propeller(s) <sup>15</sup>	—	—	—	1	1	1	1	—
	.4 force and direction of lateral thrust of the thruster(s) <sup>16</sup>	—	—	—	1	1	1	1	—
20	Radar reflector <sup>17</sup>	1 <sup>18</sup>	—	—	—	—	—	—	—



Table 2.2.1 — continued

Nos.	Navigational equipment	Number of items for ships of gross tonnage							Remarks
		< 150 <sup>1</sup>	≥ 150 <sup>1</sup>	≥ 300	≥ 500	≥ 3000	≥ 10000	≥ 50000	
21	Hand lead, set	1	1	1	1	1	1	1	—
22	Navigational sextant	—	—	1	1	1	1	2	—
23	Marine chronometer	—	—	1	1	1	1	1	Two chronometers are required in passenger ships and special purpose ships of more than 300 gross tonnage
24	Stopwatch	—	1	1	2	3	3	3	—
25	Star globe or any equivalent instrument	—	—	—	1	1	1	1	Not required in ships of restricted areas of navigation <b>R2</b> , <b>R2-RSN</b> , <b>R2-RSN(4,5)</b> , <b>R3</b> , <b>R3-RSN</b>
26	Prismatic binocular	1	1	1	2	3	4	4	—
27	Anemometer	—	—	1	2	2	2	2	Not required in ships of restricted area of navigation <b>R3</b>
28	Aneroid barometer	—	1	2	2	2	2	2	—
29	Inclinometer	1	1	1	2	2	2	2	In ships which require the VDR to be fitted and are built after 1 January, 2019, at least one inclinometer shall be electronic

<sup>1</sup> The list of navigational equipment of passenger ships of less than 500 gross tonnage shall be determined according to column 3 (≥ 300) of the Table, at that the requirements of items 15 and 20 of the Table shall be met.

<sup>2</sup> Remote transmission of the standard magnetic compass dial readings to the principal steering position is required.

<sup>3</sup> The radionavigation system used (global navigation satellite system or terrestrial radionavigation system) shall be available for use at all times throughout the intended voyage.

<sup>4</sup> Where two radars are required, they shall operate independently of one another.

<sup>5</sup> Not required on ships constructed on or after 1 July 2002 (refer to 1.1.5 of this Part).

<sup>6</sup> Provision shall be made for transmitting heading information for input to the equipment referred to in items 4, 4.1, 11 of the Table.

<sup>7</sup> Not required provided the ship is fitted with a gyrocompass to transmit heading information for input to the equipment referred to in items 4, 4.1, 11 of the Table.

<sup>8</sup> Provision shall be made for transmitting heading information for input to the equipment referred to in items 4, 4.2, 4.3, 11 of the Table, and for supplying heading information visually at the emergency steering position. The heading information shall be supplied visually at the emergency steering position by a gyrocompass repeater.

<sup>9</sup> Required in ships of less than 1600 gross tonnage as far as practicable.

<sup>10</sup> Bottoms of the echo sounders and Doppler logs to be installed on the ships operating in polar waters (refer to IMO MSC.386(94)) with ice class mark **Icebreaker** or **Arc4** — **Arc9** in the class notation shall be protected from damage by ice.

<sup>11</sup> Not required in cargo ships not engaged in international voyages.

<sup>12</sup> Passenger ships irrespective of size shall be fitted with a voyage data recorder.

<sup>13</sup> Ships engaged on international voyages shall be fitted with an electronic chart display and information system (ECDIS) within the time period specified in 1.1.8. In ships to which paragraph 1.1.8 is inapplicable, fitting of the ECDIS system is not required provided corrected paper nautical charts are available on board to plan and display the ship's route for the intended voyage and to plot and monitor positions throughout the voyage.

<sup>14</sup> Ships, irrespective of their date of construction, fitted with an automatic identification system and operated exclusively within sea area A1 shall be exempted from the requirement for installation of LRIT system equipment.

<sup>15</sup> To be fitted where controllable pitch propeller(s) is/are provided.

<sup>16</sup> To be fitted where thruster(s) is/are provided.

<sup>17</sup> Not required where the ship's effective echoing area is sufficient to enable detection by radar at 9 GHz and 3 GHz (corresponding to a wave length of 3 and 10 cm, respectively).

<sup>18</sup> The provisions for the equipment are set out in Part III "Signal Means".

**N o t e s :** 1. Non-self-propelled ships intended for being towed and pushed at sea, as well as for long period anchorage outside the port aquatorium or the roadstead and having people on board shall be provided with binoculars, hand lead and inclinometer.

2. The ships of river-sea navigation (marks for restricted areas of navigation in the character of classification of a ship are **R2-RSN** and **R3-RSN**) engaged on inland waterways voyages shall be fitted with the additional radar meeting the requirements in 5.7.59. The additional radar is not required in case the radar ultimately complying with the requirements of 5.7 is installed on board such ships.

3. In ships under 3000 gross tonnage the second radar with an effective display diameter not less than that required by 5.7.2 may be installed.

4. In ships fitted with a radar with a plotting aid (EPA, ATA or ARPA) and/or a track control system, a speed and distance measuring device through the water (log) shall be provided.

5. In ships of 500 gross tonnage and upwards but less than 10000 constructed before 1 September 1984 no log is required, provided it has not been fitted according to the ship design during construction of the ship.

6. On ships contracted for construction on or after 1 January 2007, gyrocompass which shall be supplied from the main and emergency source of electrical power as well as from the transitional source of power which may be an accumulator battery may be used as a spare magnetic compass. In this case such gyrocompass cannot be considered as required by item 7 of the present Table for ships of 500 gross tonnage and more.

**2.2.2** In addition to the requirement of 2.2.1, it is recommended that ships shall be fitted with:

- .1 a unified timing system;
- .2 an integrated navigation system (in the case of ships of more than 10000 gross tonnage);
- .3 rate-of-turn indicator (in the case of ships with the navigation bridge located forward as ships provided with an integrated navigation system);
- .4 radiobeacon station (in the case of ships with helicopter equipment);
- .5 weather station (ships of 3000 gross tonnage and upwards).

**2.2.3** All ships having in the class notation the distinguishing marks **Icebreaker6** — **Icebreaker9** (icebreakers), **PC1** — **PC7** (polar class ships according to IACS), in addition to requirements of 2.2.1, shall be fitted with the following equipment:

- transmitting heading device (based on global navigation satellite system (GNSS));
- shipborne equipment of the universal automatic identification system (AIS);
- log for measuring the speed and distance over the ground (use of separate receiver of global navigation satellite system, such as GPS, GLONASS or GPS/GLONASS, providing measurement and display of speed and distance over the ground);
- echo sounder, other than the one installed in accordance with Table 2.2.1;
- radar operating in 3 GHz band (10 cm wavelength);
- navigation display equipment (multifunction display);
- separate indicators of rudder angle for each of the individually controlled rudders;
- receivers of ice and weather charts;
- devices for display of ice information (ice conditions).

**2.2.4** Navigational equipment as required in Table 2.2.1 may be replaced by any recently invented, designed or modified equipment, provided it is equivalent in respect of its application, has the required or better operational and technical characteristics and is approved by the Register.

**2.2.5** Navigational equipment in excess of that required by the present Part may be installed on board ship as additional equipment, provided its arrangement and operation do not interfere with the normal use of required navigational devices and instruments, influence the readings thereof and diminish safety of navigation.

The navigational equipment fitted on board ship additionally to the mandatory equipment specified in Table 2.2.1 shall be of the type approved by the Register and meet the performance requirements imposed upon the mandatory equipment.

**2.2.6** Where a speed and distance measuring device over the ground (absolute log) is fitted in a ship, it shall comply with the requirements of 5.4.

On board the ships of 50000 gross tonnage and above, as well as on other ships where the installation of the speed log measuring speed through the water and speed over the ground, these speed logs shall be provided by two separate devices.

**2.2.7** The electronic inclinometer intended for navigation and/or communication of information to the voyage data recorder (VDR) shall comply with the requirements of 5.27. The requirements of 5.27 shall apply to the electronic inclinometers installed on or after 1 July 2015, and shall not apply to the electronic inclinometers intended for other purposes, e.g. monitoring of cargo status.

**2.3 SOURCES OF POWER**

**2.3.1** All navigational equipment installed on board ship shall be provided with power supply from the main and emergency sources of electrical power.

**2.3.2** The switchboard of navigational equipment shall be supplied from the main and emergency switchboards by two independent feeders (see Part XI "Electrical Equipment" of the Rules for the Classification and Construction of Sea-Going Ships).

**2.3.3** Power supply for the ship navigational equipment shall be provided in accordance with the requirements in Table 2.3.3.

Table 2.3.3

Nos.	Navigational equipment	Source of energy	Minimum number of hours of continuous operation of equipment used for calculating the capacity of accumulator batteries
1	Magnetic compass (standard and spare)	Main and emergency sources of electrical power (power supply from emergency source of electrical power may be substituted by that from accumulator batteries)	6
2	Gyrocompass	Main and emergency sources of electrical power	—
3	Log	Main and emergency sources of electrical power	—
4	Rate-of-turn indicator	Main and emergency sources of electrical power	—
5	Echo sounder	Main and emergency sources of electrical power	—
6	Radar	Main and emergency sources of electrical power	—
7	Automatic radar plotting aids	Main and emergency sources of electrical power	—
8	Radionavigation system receivers <sup>1</sup>	Main and emergency sources of electrical power	1
9	Unified timing system	Main source of electrical power	—
10	Radiobeacon station	Main source of electrical power and accumulator batteries (power supply from accumulator batteries may be substituted by that from the emergency source of electrical power)	6
11	Electronic chart display and information system	Main and emergency sources of electrical power	—
12	Back-up electronic chart display and information system	Main and emergency sources of electrical power	—
13	Sound reception system	Main and emergency sources of electrical power	—
14	Voyage data registrator, simplified voyage data recorder	Main and emergency sources of electrical power, accumulator batteries (integrated) <sup>2</sup>	2
15	Apparatus of the ship automatic identification system	Main and emergency sources of electrical power	— <sup>3</sup>
16	Heading control system	Main source of electrical power	—
17	Ship's track control system	Main source of electrical power	—
18	Transmitting heading device	Main and emergency sources of electrical power	—
19	Equipment of long range identification and tracking system (LRIT system) <sup>4</sup>	Main and emergency sources of electrical power <sup>4</sup>	—
20	Bridge navigational watch alarm system (BNWAS)	Main source of electrical power	6 <sup>5</sup>
21	Ship weather station	Main and emergency sources of electrical power	—
22	Analog-digital signal converter	Main and emergency sources of electrical power	—
23	Digital signal multiplier	Main and emergency sources of electrical power	—
24	Electronic inclinometer	Main and emergency sources of electrical power	—

<sup>1</sup> Radio navigation system receivers used for automatic input into GMDSS radio installations of data concerning ship's position and time when it was fixed shall be also supplied from the reserve source of electrical power required by 2.3.3, Part IV "Radio Equipment".

<sup>2</sup> In VDR/S-VDR provision shall be made for an automatic charging device to maintain the accumulator batteries in charged condition and to enable recharging of the completely discharged batteries during 10 h after the power supply of the VDR from the main source of electrical power has been restored.

<sup>3</sup> Where on ships constructed before 1 July 2002 an accumulator battery is an emergency source of electrical power, the capacity of this battery shall be sufficient to provide operation during at least one hour.

<sup>4</sup> Refer also to 5.23.3.5.

<sup>5</sup> Refer also to 5.22.15.

It is recommended to provide a continuous power supply device on board to ensure operational integrity of navigational equipment and safety of navigational information in case the main and emergency sources of electrical power are out of order or for the time required to change over from the main source of electrical power to the emergency source or vice versa. In this case, audible alarm and visual indication shall be provided at the position from which the ship is normally navigated to indicate the change-over to the source of continuous power supply. It shall not be possible to disable this alarm and indication. Both the alarm condition and indication shall reset automatically when the ship's supply has been restored. Provision shall be made for the manual acknowledgement of audible alarm.

**2.3.4** All electrically operated navigational devices and instruments (except heading or track control systems) shall be supplied by separate feeders from one common switchboard of navigational equipment.

Heading control system and track control system shall be supplied under 5.5.14, Part XI "Electrical Equipment" of the Rules for the Classification and Construction of Sea-Going Ships.

**2.3.5** Where any kinds of navigational equipment are designed for being fed from various primary currents or various primary voltages, such equipment is exceptionally allowed to be fed from other switchboards, provided they are located close to the principal switchboard of the navigational equipment.

**2.3.6** If any kinds of navigational equipment are fed from additional switchboards, such switchboards shall get the supply from the corresponding sources of power through separate feeders.

**2.3.7** The switchboard (switchboards) of navigational equipment shall be provided with switches and fuses or with circuit-breakers. These devices shall be fitted in circuits leading to each kind of navigational equipment.

Connecting of consumers not associated with navigational equipment to the navigational equipment switchboard is not allowed.

**2.3.8** Every accumulator battery, the use of which is allowed for supply of several consumers, shall have a capacity required in Table 2.3.3 which is sufficient for continuous and simultaneous operation of all consumers connected to it without recharging.

**2.3.9** For **OMBO** ships:

**.1** the radio and navigational equipment shall be supplied from the ship's mains in compliance with the requirements of Part XI "Electrical Equipment" of the Rules for the Classification and Construction of Sea-Going Ships;

**.2** the switchboards of radio and navigational equipment shall be supplied from the main and emergency switchboards by two independent feeders equipped with automatic switch in case of stopping the power supply from the main switchboard. In this case, audible and visual alarms shall be operated;

**.3** where computerized equipment are interconnected through a computer network, failure of this network shall not prevent individual equipment from performing their functions;

**.4** bridge navigational watch alarm system (BNWAS) shall be supplied from the navigational equipment switchboard (refer also to 5.22.15).

## **2.4 AERIALS**

**2.4.1** In every ship there shall be erected some types of aerials which provide operation of the following navigational equipment:

- .1** radar;
- .2** radionavigation system receivers;
- .3** radiobeacon station (where required);
- .4** ship automatic identification system (AIS).

**2.5 SPARE PARTS AND SUPPLY**

**2.5.1** Every ship of more than 500 gross tonnage and passenger ship of more than 300 gross tonnage shall be supplied with minimum amount of spare parts, portable measuring instruments, tools and materials assigned for normal operation of navigational equipment installed in these ships.

**2.6 MAINTENANCE OF AND REPAIRS TO NAVIGATIONAL EQUIPMENT**

**2.6.1** Maintenance of and repairs to the shipborne navigational equipment shall be provided to ensure its working ability.

**2.6.2** The manner of navigational equipment technical servicing and of making repairs to it shall be chosen by the Shipowner and agreed with the Register.

**2.6.3** The firms providing technical servicing and repairs to the navigational equipment shall be recognized by the Register for performing such tasks.

### **3 SPACES INTENDED FOR INSTALLATION OF NAVIGATIONAL EQUIPMENT. ARRANGEMENT OF NAVIGATIONAL EQUIPMENT AND CABLING**

#### **3.1 GENERAL**

**3.1.1** Every ship to be fitted with the navigational equipment shall be provided with the following spaces:

- .1** wheelhouse and chartroom (combined or separated);
- .2** spaces intended for installation of individual units of navigational equipment (generator room and/or operating room) — unless provision is made for fitting all navigational equipment directly on the bridge;
- .3** accumulator battery room;
- .4** compartment for installation of master gyrocompass (unless provision is made for installing the master gyrocompass in the wheelhouse);
- .5** trunk for log and/or echo sounder.

**3.1.2** All spaces intended for installation of the navigational equipment shall be provided with electrical lighting, heating (with the exception of trunk for log and/or echo sounder) and the plug sockets shall be fitted therein.

**3.1.3** Navigational devices, appliances, cables and other equipment fitted on the navigation bridge shall be so arranged that the magnetic fields produced by such equipment shall not distort the magnetic compass readings by more than  $\pm 0,5^\circ$ .

**3.1.4** On passenger ships, navigational equipment shall be so arranged as to meet the requirements of 2.2.6 — 2.2.8, Part VI "Fire Protection" of the Rules for the Classification and Construction of Sea-Going Ships, which stipulate that this equipment shall remain operable in case of fire or flooding of any watertight compartment to ensure safety of navigation when the ship is on its way back to a port.

At least the following navigational equipment shall remain operative:

- .1** standard magnetic compass with device for taking bearings and deviation table;
- .2** radionavigation system receiver;
- .3** radar (3 cm);
- .4** ECDIS or portfolio of nautical charts and nautical publications.



### 3.2 NAVIGATION BRIDGE<sup>1</sup>

**3.2.1** Design of the navigation bridge and arrangement of the equipment thereon shall be such as to ensure the possibility of effective steering of the ship and to comply with the applicable requirements of the Appendix to this Part.

**3.2.2** The navigation bridge shall be located above all deck constructions which are at the level of the freeboard deck or higher with exception of smoke funnels.

**3.2.3** The view of the sea surface from the conning position shall not be obscured by more than two ship's lengths or 500 m, whichever is less, forward of the bow to 10° on either side under all conditions of draught, trim and deck cargo, at that the ballast water exchange may result in reduced horizontal fields of vision or increased blind sectors indicated in 3.2.7 — 3.2.9, which shall be taken into consideration by the master when performing navigational functions.

The maximum and minimum values of the forward and aft draught at which the present visibility requirement fails to be fulfilled shall be entered in the Stability Information in accordance with 3.4.1.6.4 of Appendix 1 to Part IV "Stability" of the Rules for the Classification and Construction of Sea-Going Ships.

**3.2.4** Blind sectors, caused by cargo, cargo gear or other obstructions outside of the wheelhouse which obstruct the view of the sea surface ahead (in 180° sector) of the ship as seen from the conning position shall not exceed 10° each. The total blind sector of the obstructed view shall not exceed 20°. The clear sectors between blind sectors shall be at least 5°. However, in the view described in 3.2.3, each individual sector shall not exceed 5°.

**3.2.5** The lower edge of the navigation bridge front windows shall be as low as possible for not to obstruct to the forward view.

The height of the desks arranged immediately adjacent to the fore bulkhead of wheelhouse shall not exceed 1200 mm.

**3.2.6** The upper edge of the navigation bridge front windows shall be at a height not less than 2000 mm above the deck surface to provide a forward view from the conning position for a person with a height of eye of 1800 mm, when the ship is pitching up to 10°.

In ships where the forward view in the centre-line is obstructed by masts, cranes and other deck structures, two additional positions giving a clear view ahead shall be provided, one on the port side and one on the starboard side of the centreline, no more than 5 m apart.

**3.2.7** The horizontal field of vision from the conning position shall be provided over an arc of at least 225°, that is from right ahead to not less than 22,5° abaft the beam on either side of the ship.

**3.2.8** From each bridge wing the horizontal field of vision shall be provided over an arc of not less than 225°, that is from at least 45° on the opposite bow through right ahead and then from right ahead to right astern through 180° on the same side of the ship.

**3.2.9** From the main steering position the horizontal field of vision shall be provided over an arc from right ahead to at least 60° on each side of the ship.

**3.2.10** The ship's side shall be visible from the bridge wing.

**3.2.10.1** The ship side is considered as visible if:

a view from the bridge wing plus a distance corresponding to a reasonable and safe distance of a seafarer leaning over the side of the bridge wing, which needs not to be more than 400 mm, to the location vertically right under the maximum beam of the ship at the lowest seagoing draught is not obstructed (refer to Fig. 3.2.10.1); or

the sea surface at the lowest seagoing draught and with a transverse distance of 500 mm and more from the maximum beam throughout the ship's length is visible from the side of the bridge wing (refer to Fig. 3.2.10.2).

---

<sup>1</sup>The requirements of 3.2.3 to 3.2.14 are applicable to ships with overall length 55 m and more constructed on 1 July 1998 or after this date. The requirements of 3.2.3 to 3.2.14 are applicable as far as practicable and expedient to ships with overall length less than 55 m. Ships of unconventional design, which on the opinion of the Flag State Administration cannot meet the requirements of 3.2.3 to 3.2.14 shall be provided with measures and arrangements to achieve a level of visibility from the bridge that is as near as practical to those requirements.

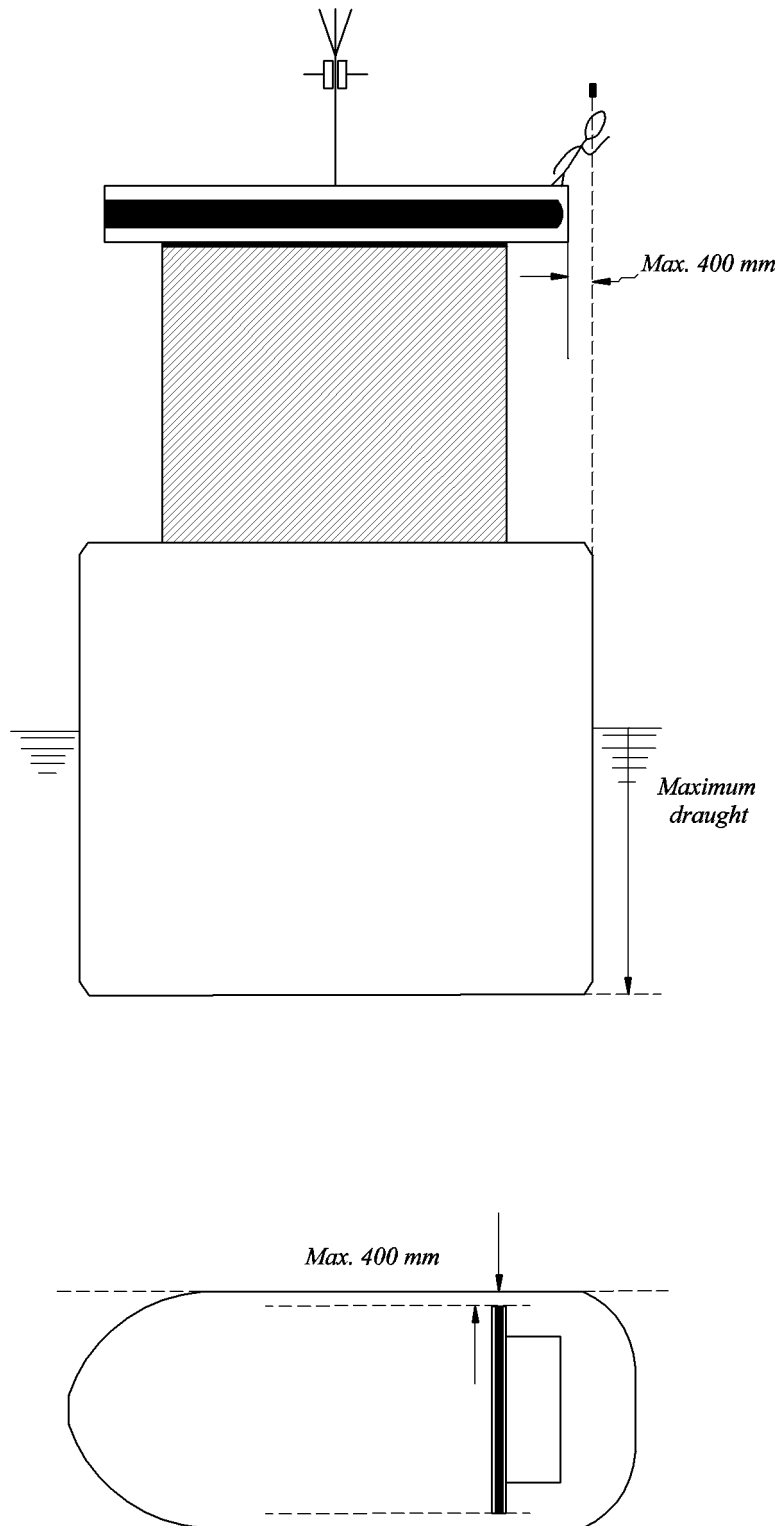
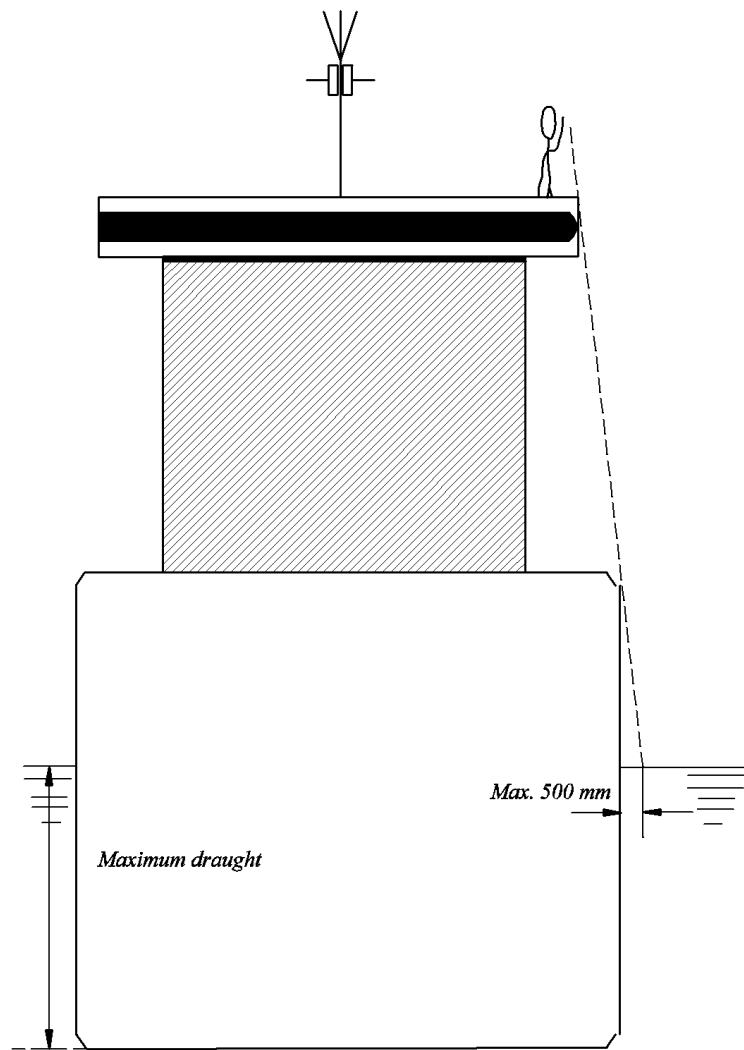

Fig. 3.2.10.1



Where the maximum width of the ship occurs

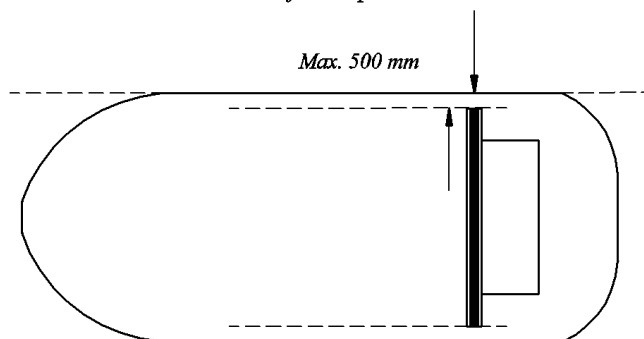

Fig. 3.2.10.2

**3.2.10.2** For particular types of ships as tug/tow boat, offshore supply vessels, salvage ship, floating crane and other similar craft, in ensuring visibility of the ship side, the bridge wings shall at least extend to a location from which the sea surface, at the lowest service draught and at a transverse distance of 1500 mm from the maximum beam throughout the ship's length is visible. If this ship type is changed to a type other than those addressed in this paragraph then the requirement of 3.2.10.1 shall be complied with.

**3.2.10.3** The use of a remote camera system may be accepted for ships of unconventional design as means for achieving the view of the ship's side from the bridge wing, provided the above system meets the following requirements.

**3.2.10.4** The installed remote camera system shall be redundant from the circuit breaker to the camera and screen, including communication cables, i.e. the system shall provide on each side of the ship redundancy of:

- .1 power cables and automatic circuit breakers from the main switchboard to the camera and the screen;
- .2 camera;
- .3 screen;
- .4 transmission lines from the camera to the display screen;
- .5 components associated with these lines and cables.

**3.2.10.5** The remote camera system is powered from the ship's main source of electrical power and is not required to be powered by the emergency source of electrical power.

**3.2.10.6** The remote camera system is capable of continuous operation under environmental conditions as per 5.1 of the present Part.

**3.2.10.7** The view provided by the remote camera system is regarded sufficient for the purpose and is also displayed at locations where the manoeuvring of the ship may take place.

**3.2.10.8** The upper edge of the ship's side abeam shall be viewed visually from all locations where the manoeuvring of the ship may take place.

The solution on the permissibility of the use of remote camera system is accepted by the Flag State Administration (national authority).

**3.2.11** Number of framings between navigation bridge windows shall be minimum and they shall not be installed immediately forward of workstation of watch officer assistant and helmsman.

**3.2.12** For avoiding reflections the bridge front windows shall be inclined from the vertical plane top out, at an angle of not less than 10° and not more than 25°.

It is recommended that bridge rear and side windows shall be inclined in a similar manner (with the exception of doors).

**3.2.13** Polarized and tinted glass for windows shall not be fitted.

To ensure a clear view in bright sunshine, it is recommended that removable sunscreens with minimum colour distortion shall be provided.

**3.2.14** At all times regardless of weather condition, at least two of the navigation bridge front windows shall provide a clear view and depending on the bridge configuration, an additional number of windows shall be fitted with means of effective cleaning, anti-icing and anti-fogging devices.

In ships having distinguishing marks **Icebreaker6** — **Icebreaker9**, **PC1** — **PC7** in the class notation the navigation bridge windows providing the field of vision aft shall be fitted with means of effective cleaning, anti-icing and anti-fogging devices.

**3.2.15** The arrangement of navigational equipment in the wheelhouse and their design shall provide the possibility to effect steering of the ship under all operating conditions including emergency conditions.

**3.2.16** Some navigational devices, instruments and ship manoeuvring control desks may be installed on navigation bridge wings.

**3.2.17** Provision shall be made for free passage of not less than 1200 mm in width from one navigation bridge wing to the other.

**3.2.18** The distance from the fore bulkhead of the wheelhouse to any control desk or device (instrument) located on the navigation bridge shall be not less than 800 mm. The distance between two desks shall be not less than 700 mm.

The combined ship control desk may be installed close to the fore bulkhead of the wheelhouse.

With any of the above arrangements of the desk provision shall be made for observation of the environmental conditions through the windows of the wheelhouse.

The requirements of this paragraph are applicable, as far as practicable and expedient, to the ships of less than 1600 gross tonnage.

**3.2.19** The clear height between the bridge deck surface covering and the underside of the deck head beams shall be at least 2250 mm. The lower edge of deckhead mounted equipment shall be at least 2100 mm above the deck in open areas, passageways and at standing workstations.

**3.2.20** All navigational information shall be presented to the operator in the interpreted and processed form so that he could save time for taking measures.

It is recommended that the integrated electronic indicators of navigational information be used.

**3.2.21** Navigational devices and instruments used for direct steering control of the ship or connected with the controls shall be such that displayed data could be read at a distance not less than 1000 mm under all operating conditions.

All other devices and instruments located on the navigation bridge shall be such that their indications could be read at a distance not less than 2000 mm under normal lighting.

**3.2.22 General requirements to the OMBO ship's navigation bridge.**

**3.2.22.1** The bridge configuration, the arrangement of consoles and equipment location shall enable the watch officer to perform its duties from one or several workstations.

**3.2.22.2** The main conning position of the ship shall be arranged in a way to enable the ship's control and manoeuvring, and a proper lookout by one person under normal operating conditions.

All relevant instrumentation and controls shall be easily visible, audible and accessible from the watch officer workstation.

**3.2.22.3** The field of vision from the ship's main conning position shall be such as to enable observation of all objects which may influence the ship's safety.

The main workstation on the navigation bridge shall have the field of vision according to the requirements in 3.2.3, 3.2.4, 3.2.7 and 3.2.9.

**3.2.22.4** To perform one or several auxiliary functions, other workstations may be arranged on the navigation bridge. The field of vision from these workstations shall also comply with the foregoing.

**3.2.22.5** The bridge layout design and workstations shall provide the coordinated performance of two people if needed under operational conditions.

**3.2.22.6** External sound signals, that are audible on the open deck, shall also be audible inside the wheelhouse. For this purpose, the sound reception system complying with the requirements of 5.19 shall be installed aboard.

**3.2.22.7** The navigation bridge and its equipment design shall comply with the requirements providing the watch officer with a safe performance of its duties related to the ship's control. For this purpose:

- .1 instruments and equipment shall not have sharp edges, corners and protuberances;
- .2 hand-rails shall be fitted inside of the wheelhouse and around consoles;
- .3 the deck in the wheelhouse shall have anti-slip coating;
- .4 doors to the bridge wings shall be easy to open, close and secure at the opened and closed positions;
- .5 chairs at the navigation bridge workstations shall be movable, adjusted by height and secured on a deck at the set place.

**3.2.23 OMBO ship's navigation bridge equipment.**

**3.2.23.1** The instrumentation and controls at the ship's main conning position shall be arranged to enable the watch navigator to:

- .1 determine and plot the ship's position, course and speed;
- .2 analyse the traffic situation in the water area;
- .3 decide on collision avoidance manoeuvres;
- .4 alter course;
- .5 change speed;
- .6 effect internal and external communications related to manoeuvring including communication on the VHF;

- .7 give sound signals;
- .8 hear sound signals being in the wheelhouse;
- .9 monitor course, speed, track, propeller revolutions (pitch), rudder angle and depth of water;
- .10 timely record voyage data.

**3.2.23.2** The following equipment shall be installed on the navigation bridge of **OMBO** ships. The technical parameters of this equipment shall comply with the requirements given in the appropriate sections of the present part of the Rules:

.1 radar equipment which shall give warning on emergence of a dangerous target with a lead of 6 to 30 min depending on the permissible time of closing to a minimum distance;

.2 ship's heading and/or track control system giving alarm when the ship deviates from the pre-set course or track for a value exceeding the limits. An alarm shall be given by a device which is independent from a control system;

.3 pre-warning system to give a signal at the approach of the next waypoint (when following the planned track);

.4 alarm system to give a signal when approaching dangerous soundings (the water depth beneath the ship is less than a predetermined value) or boundaries of a zone prohibited for ship's navigation;

.5 two independent electronic position fixing systems capable of a passing determination in data processed and of a warning alarm generation in case of a malfunction or failure of either system;

.6 electronic chart display and information system (ECDIS);

.7 voyage data recorder;

.8 automatic identification system;

.9 two independent radars; one of them shall operate within 3 cm range;

.10 magnetic compass;

.11 gyrocompass (repeater);

.12 log (repeater);

.13 echo sounder;

.14 propulsion plant remote control system;

.15 whistle control device;

.16 window wipe and wash control device;

.17 main workstation console lighting control device;

.18 steering gear pump selector/control switches;

.19 internal communication system;

.20 radio equipment in accordance with 2.2, Part IV "Radio Equipment";

.21 wheelhouse heating/cooling control system;

.22 weather station display unit.

**3.2.23.3** The alarm/warning and communication system (AWCS) shall be provided on the navigation bridge of the OMBO ships which generates audible and visual alarms in the following cases:

.1 the ship's approach to the pre-set minimum depth under a keel;

.2 detection of a dangerous target;

.3 deviation from a pre-set course and/or track;

.4 an approach to the next waypoint (when following a pre-set track);

.5 a gyrocompass malfunction;

.6 a sharp drop below a permissible level or failure of power supply for navigational equipment;

.7 a malfunction of a system verifying watch officer fitness;

.8 failure of navigation lights.

Devices to acknowledge AWCS signals shall be provided at all workstations on the navigation bridge. Any alarm/warning shall be automatically transferred to the master and, if he deems it necessary, to the back-up officer and to the public rooms, if not acknowledged on the bridge by the watch officer within 30 s. The alarm/warning transfer shall be operated through a fixed system. Acknowledge of alarms/warnings shall only be possible from the bridge.

Under all operational conditions a watch officer shall have a possibility to call the master and back-up officer to the bridge. A bridge call signal given by a watch officer shall be clearly audible in the cabins of the master, back-up officer and all public spaces of the ship.

If the back-up officer may attend a location not connected to the fixed communication system, he shall be provided with a wireless portable device enabling both the alarm/warning transfer and the two way speech communication with the watch officer on the navigation bridge.

In case of loss of main source power supply for an alarm transfer system an automatic changeover to an emergency source shall be provided.

**3.2.23.4** The **OMBO** ship's navigation bridge shall have priority in the service telephone communication system.

**3.2.23.5** The bridge navigational watch alarm system (BNWAS) shall be provided on the navigation bridge of the **OMBO** ship which shall not affect the watch officer's duties performed.

The system shall be capable of setting a time period for fitness verification within 3 to 12 min, and arranged so that only the ship's master had access to the system components for setting appropriate intervals, and also shall have protection against an unauthorized intervention.

The system shall provide for the acknowledgement of a check signal at any workstation on the navigation bridge.

Any attempt to switch off a fitness verification system shall be recorded and if the system and its supply fail the relevant alarm shall be given through the AWCS.

If an integrated navigation system is fitted aboard the ship, the watch officer fitness may be verified with a special program which shall not cause an additional workload for a watch officer.

**3.2.24 Performance standards for bridge alert management.**

**3.2.24.1** Performance standards for bridge alert management (BAM) shall ensure harmonization of the priority, classification, handling, distribution and presentation of alerts, to enable the bridge team and the pilot to devote full attention to the safe operation of the ship and to immediately address and identify any alert situation requiring response actions of the operator to maintain the safe operation of the ship.

The BAM architecture and the acknowledgement/silencing concept shall avoid the unnecessary distraction of the bridge team by redundant and superfluous audible and visible alarm announcements. It reduces the cognitive load on the operator by minimizing the information presented to which is necessary to assess the situation.

**3.2.24.2** The present performance standards have priority over other alert systems and shall be applied to all alerts presented on or transmitted to the navigation bridge of a ship. The performance standards are based on a modular concept which necessitates provision of the following below modules.

**3.2.24.3** Module I — Presentation and handling of alerts on the bridge:

**.1** the BAM shall provide:

the means used to draw the attention of the bridge team and pilot to the existence of alert situations;

the means to enable the bridge team and pilot to identify and address that condition;

the means for the bridge team and pilot to assess the urgency of different alert situations in cases where more than one alert situation shall be handled;

the means to enable the bridge team to handle alert announcements;

the means to manage all alert-related states in distributed system structure in a consistent manner;

If practicable, there shall be not more than one alert for one situation that requires attention;

**.2** as alerts can be displayed at several locations, the presentation of the alert on the bridge equipment shall be consistent as far as practicable with respect to how alerts are displayed, silenced and acknowledged at any workstation;

**.3** it shall be possible to provide the central alert management human machine interface (CAM-HMI) at least on the workstation for navigating and maneuvering, and if provided at the workstation for monitoring;

**.4** if an integrated navigation system (INS) is installed on the bridge, the functionality of the INS alert management HMI and the CAM-HMI shall be integrated;

**.5** the BAM shall distinguish between the four priorities listed:

emergency alarms;

alarms;  
warnings; and  
cautions:

**.5.1** alerts shall be assigned to a priority level using the following criteria for classification of alerts:  
emergency alarms:

alarms which indicate that immediate danger to human life or to the ship and its machinery exists and that immediate action shall be taken;

alarms:

conditions requiring immediate attention and action by the bridge team to avoid any kind of hazardous situation and to maintain the safe operation of the ship;

escalation required as alarm from a not acknowledged warning;

warnings:

conditions or situations which require immediate attention for precautionary reasons to make the bridge team aware of conditions which are not immediately hazardous, but may become so;

cautions:

awareness of a condition which still requires attention out of the ordinary consideration of the situation or of given information;

**.5.2** alerts shall be separated into three categories of alerts: A, B and C.

Category A alerts are specified as alerts where information at a task station directly assigned to the function generating the alert is necessary, as decision support for the evaluation of the alert-related condition, e.g.:

danger of collision; and

danger of grounding.

Where category A alerts cannot be acknowledged at a HMI, this fact shall be clearly indicated to the operator.

Category B alerts are specified as alerts where no additional information for decision support is necessary besides the information which can be presented at the CAM-HMI.

Category C alerts are specified as alerts that cannot be acknowledged on the bridge but for which information is required about the status and treatment of the alerts, e.g. certain alerts from the main engine;

**.6** when complying with the requirements for the BAM, the state of an alert shall be consistently distributed and presented for the BAM and all associated displays:

**.6.1** the presentation of alarms and warnings shall meet the requirements of Section 6;

**.6.2** the handling of emergency alarms shall meet the requirements of the IMO Code of Alerts and Indicators;

**.6.3** the BAM shall distinguish between different alarm states:

unacknowledged alarm; and

acknowledged alarm.

When an alarm condition is detected and an alert is released, it shall be indicated as unacknowledged alarm:

initiate an audible signal, accompanied by the visual alarm announcement;

provide a message of sufficient detail to enable the bridge team to identify and address the alarm condition; and

may be accompanied by speech output presented at least in English, using harmonized alert voice messages.

An unacknowledged alarm shall be clearly distinguishable from those existing and already acknowledged. Unacknowledged alarms shall be indicated by flashing and by an audible signal.

The characteristics of the audible alarm signal, whether used singly or in combination with speech, shall be such that there is no possibility of mistaking it for the audible signal used for a warning.

Means may be provided at an HMI to temporarily silence audible alarm signals, if the alert identification is provided at the HMI. If an alarm, which can be acknowledged on the bridge (categories A and B), is not acknowledged within 30 s the audible signal shall start again or as specified in the equipment performance standards.



It shall be also possible to temporarily silence category C alarms. The alarm shall be retriggered after a specified period of time consistent with the Code on Alerts and Indicators when the alarm is not acknowledged at the specified workplace (e.g. engine room).

The visual indication for an unacknowledged alarm shall continue until the alarm is acknowledged, unless specified otherwise in the equipment performance standards.

The audible indication, if not temporarily silenced, for an unacknowledged alarm shall continue until the alarm is acknowledged or the alarm condition is rectified.

The audible signal of an unacknowledged alarm shall be only ceased when the alarm condition is rectified.

An acknowledged alarm shall be indicated by a steady visual indication.

The visual indication for an acknowledged alarm shall continue until the alarm condition is rectified;

**.6.4** the BAM shall distinguish between different warning states:

unacknowledged warning; and

acknowledged warning.

When a warning condition is detected and warning is released, warning shall be indicated as unacknowledged warning:

initiate a single (momentary) audible signal, accompanied by the visual warning announcement;

provide a message of sufficient detail to enable the bridge team to identify and address the warning condition; and

may be accompanied by speech output presented at least in English, using harmonized alert voice messages.

An unacknowledged warning shall be clearly distinguishable from those existing and already acknowledged. Unacknowledged warnings shall be indicated by flashing and by an audible signal.

The characteristics of the momentary audible warning signal, whether used singly or in combination with speech, shall be such that there is no possibility of mistaking it for the audible signal used for an alarm.

The visualization for an unacknowledged warning shall continue until the warning is acknowledged, unless specified otherwise in the equipment performance standards where the visual indication can be ceased when the alarm condition is rectified.

An acknowledged warning shall be indicated by a steady visual indication.

The visual indication for an acknowledged warning shall continue until the warning condition is rectified;

**.6.5** a caution shall be indicated by a steady visual indication. No acknowledgement shall be necessary for a caution.

A caution shall be automatically removed after the condition is rectified.

A message shall be provided of sufficient detail to enable the bridge team to identify and address the caution condition;

**.6.6** the alert escalation shall be compliant with the alert escalation requirements of the individual performance standards.

An unacknowledged warning shall be repeated as a warning after a limited time period not exceeding 5 min; or shall be changed to alarm priority after a limited time period not exceeding 5 min; or shall be changed to alarm priority after an operator selectable time not more than 5 min, if provided; or shall be changed to alarm priority, as required by specific requirements for the individual equipment and system;

**.6.7** the alert messages presented on the bridge shall be completed with aids for decision-making, as far as practicable.

Audible annunciation of category A signals shall only occur at the task station, system or sensor directly assigned to the function generating the alert.

The audible annunciation of category B and C alerts shall be duplicated at the CAM-HMI.

**3.2.24.4** Module II – Central alert management functionality:

**.1** all alerts shall be displayed on the CAM-HMI as individual alerts or as aggregated alerts;

**.2** the CAM-HMI shall offer the possibility to display aggregated alerts;

**.3** the CAM-HMI shall provide the means to announce and indicate alerts to draw the attention of the bridge team;

.4 the CAM-HMI shall have the capability to duplicate the audible alert annunciation of the individual equipment and displays installed on the bridge for category B and C alerts;

.5 the CAM-HMI shall allow for easy identification of alerts, and the enabling of immediate identification of the alert releasing function or sensor/source;

.6 the CAM-HMI shall be designed that alert messages of the different priorities are clearly distinguishable from each other. The alert messages shall be completed with aids for decision making, as far as practicable. An explanation or justification of an alert shall be available on the operator's request;

.7 the CAM-HMI shall enable an immediate acknowledgement of individual alarms and warnings by a single operator action except for category B alerts;

.8 it shall only be possible to acknowledge alarms and warnings individually;

.9 it shall be possible to temporarily silence all audible alert signals with a single operator action at the CAM-HMI;

.10 the CAM-HMI shall be able to display at least 20 recent alerts at the same time;

.11 if the CAM-HMI is such that it can not display all active alerts simultaneously requiring the bridge team's attention, then there shall be a clear and unambiguous indication that there are additional active alerts requiring attention.

It shall be possible to display the additional active alerts and also to return to the display containing the highest priority alerts by a single operator action.

When information other than the list of active alerts (e.g. the alert history list, configurations) is presented, then it shall still be possible to see the appearance of new alerts.

As default, all the alerts shall be presented grouped in order of priority. Within the priorities the alerts shall be displayed in the order in which they occur (sequence).

Additionally, alerts may be presented in functional groups;

.12 aggregated alerts may be provided at the CAM-HMI.

As the handling of aggregated alerts requires more operator's operations and time to obtain the necessary information, alerts required for presentation on the bridge shall only be aggregated to combine multiple individual alerts of the same kind to provide one alert at the CAM-HMI for which individual presentation is anyway necessary at alert releasing task station or system.

Alerts presented on the bridge which are not required by these Rules may be aggregated for presentation on the CAM-HMI, according to the present requirements:

.12.1 only alerts of the same priority shall be combined in one aggregated alert;

.12.2 it shall not be possible to acknowledge aggregated alerts unless otherwise specified by these Rules;

.12.3 it shall be possible to temporarily silence aggregated alerts;

.12.4 individual alerts shall not trigger more than more than one aggregated alert.

Each additional new individual alert has to retrigger the aggregated alert.

If required by these Rules to be displayed as individual alert, alerts shall not be aggregated;

.13 the CAM-HMI shall support the search and identification of alerts in the alert history list. An operator accessible alert history list shall be provided by the CAM-HMI. The messages of the alert history list shall be displayed in chronological order.

Access to the alert history list and return to the active alert display shall be possible by simple operator action.

When the alert is no longer active, the message shall be kept with its entire content in an alert history list, with the date and time the alert was raised, acknowledged and rectified.

It shall be possible to keep the content of the alert history list at least for 24 h, as well as to provide display of and access to the content of the alert history list:

.13.1 the system shall provide a clear and unambiguous indication when the alert history list is being accessed and displayed;

.13.2 if an INS is installed, the functionality of INS may be extended to include the alert history functionality;

**.14** functional aspects of CAM-HMI:

**.14.1** the CAM shall handle alert information for presentation on the CAM-HMI, including priority, state;

**.14.2** alert information, including priority, state shall be distributed to appropriate functions and equipment carrying out further processing or presentation (e.g. CAM-HMI);

**.14.3** the presentation of the alert on the bridge equipment shall be consistent as far as practicable with respect to how alerts are displayed.

Before presentation of an alert on any HMI, it shall be checked wherever possible, whether the functions and equipment may have the ability to evaluate and process the alert with additional knowledge, regarding its presentation, priority, and state. If this functionality is provided the CAM shall support this further processing. The presentation of an alert shall take place after the result of the processing could have been taken into consideration;

**.14.4** only one CAM shall be active on the bridge at any one time, but it is allowed to display and operate the information on multiple CAM-HMIs. The CAM functions may be centralized or partly centralized in subsystems and interconnected via a standardized alert-related communication;

**.15** back-up and redundancies:

**.15.1** the system configuration shall allow one of the two possibilities for the layout of the back-up and redundancy functionality for the CAM-HMI:

in case of failure of the CAM-HMI, it shall be ensured that the directly connected systems and/or equipment present their alerts individually (a system failure of the CAM-HMI functionality shall not lead directly to the loss of the alert announcement functionality); or

if functionality from systems and/or equipment is transferred to the CAM and CAM-HMI, a back-up shall be provided. The back-up arrangement shall enable a safe takeover of CAM functionality and ensure that a CAM failure does not result in a critical situation. The power supply of the back-up arrangement solution shall be resistant against single failures;

**.15.2** in case of breakdown of one task station, at least one other task station shall be able to take over the CAM-HMI task;

**.16** system failures and fallback arrangements:

**.16.1** system failures shall be alerted according to these performance standards;

**.16.2** loss of system communication between the CAM and connected systems and/or equipment shall be indicated as a warning at the CAM-HMI. The alerts from the systems where the communication is lost shall be removed from the list of active alerts on the CAM-HMI. After reactivation of the communication all active alerts shall be displayed again;

**.16.3** a system/equipment failure of the CAM or the loss of system communication between the CAM and the connected systems and/or equipment shall not lead to the loss of the alert announcement functionality of the individual functions.

**3.2.24.5** Module III — Interfacing:

**.1** the communication protocol shall allow the implementation of the functions specified by these standards;

**.2** connected sources, sensors and systems taking part in the alert-related communication shall follow standardized concept to provide the following functions and operations:

unique identification of alert source identity so that originator component and/or function can be determined, as well as it being possible to differentiate between alerts originating from the same device but at different time;

distribution of alerts with its priority, state and text information;

distribution of acknowledgement, silencing and other commands for alerts from different locations, including operator input and results of system processing;

transmission of aggregated alerts with relevant information (e.g. number of alerts aggregated);

proper reconnection after disconnection or power down at any time and in any alert condition with a result of a consistent alert presentation within recovery time; and

standardized communication shall be used. Individual subsystems may use an alternative internal concept;

**.3** the CAM shall be supplied from both the main and the emergency source of electrical power with automated changeover with provision to preclude inadvertent shutdown.

After an electrical power failure the system shall restart automatically when the power is restored.

**3.2.24.6** Module IV — Requirements for technical documentation:

**.1** the system and equipment and arrangements connected therewith in consistent manner shall be delivered to ship complete with technical documentation.

Operating manual shall include:

an overall description of the CAM functionality;

a description of the redundancy concept;

a description of possible failures and their effects on the system (e.g., by using part of the failure analysis).

The installation manual shall include adequate information to allow the installation of an alert management so that it can meet all requirements of the present Part and shall include the following:

interconnection diagrams and interfacing details, including detailed information on connected systems/equipment and sensors;

instructions for the installation and connection of facilities for alert acknowledgement and cancellation, including the BNWAS;

the details of the power supply arrangements;

**.2** manufacturer or system integrator of CAM shall declare the following information relating to the system configuration:

basic system configuration (system design principles);

data flow schematic diagram and its interpretation;

back-up and redundancy arrangement;

**.3** a failure analysis, at functional level, shall be performed and documented for the CAM. The failure analysis shall verify that a failure of the CAM shall not affect the functionality of the connected systems and sensors including their alert announcement functionality;

**.4** technical documentation enabling onboard familiarization training shall be provided for the CAM. The onboard familiarization material shall explain configuration, functions, limitations, controls, displays, alerts and indications. Furthermore, onboard familiarization with technical documentation shall explain the results of operational actions as acknowledgement, silencing for the CAM-HMI and the connected systems.

### **3.3 GENERATOR ROOM**

**3.3.1** The generator room which is intended for installation of converters used for the navigational equipment shall be located in close proximity to the wheelhouse or the operating room if the latter is available in a ship.

However, the generator room shall be so located that the acoustic noise caused by operating generators shall not be heard on the navigation bridge.

**3.3.2** The generator room shall be provided with heating, ventilation and electric lighting as to ensure effective operation of the equipment installed therein. Steam and hot-water heating is not allowed. The deck of the generator room shall be covered with linoleum or any other durable electric insulating material.

**3.3.3** Rotary converters and various electrical devices shall be installed in the generator room in compliance with the requirements stated in Part XI "Electrical Equipment" of the Rules for the Classification and Construction of Sea-Going Ships.

### **3.4 ACCUMULATOR BATTERY ROOM**

**3.4.1** The accumulator batteries feeding the navigational equipment may be installed in the accumulator battery room of the radio communication facilities provided that they cause no radio interference during radio reception.

**3.4.2** If a ship is equipped with the accumulator battery room which is intended solely for the navigational equipment, it shall comply with the requirements specified in 3.3, Part IV "Radio Equipment".

**3.4.3** It is permitted to place accumulator batteries in special boxes complying with requirements of 3.3.6, Part IV "Radio Equipment".

### **3.5 COMPARTMENT INTENDED FOR INSTALLATION OF MASTER GYROCOMPASS**

**3.5.1** The compartment intended for installation of master gyrocompass shall comply with the following requirements:

**.1** be as close as possible to the centreline of the ship and to the midship section at the level of one of the existing waterlines;

**.2** be insulated against moisture and penetration of dust, soot, steam, water, smoke and noxious exhalations. It is recommended that air conditioning shall be provided;

**.3** in addition to main lighting, be provided with portable and emergency electric lighting, as well as with means of two-way communication with the navigation bridge. The communication shall be of two-way system or be part of the ship's control communication system (automatic telephone station may be used as a duplicate means of communication);

**.4** instruments or equipment not related to the technical aids of navigation shall not be installed in the compartment;

**.5** it is not permitted to lay the pipelines through the compartment excepting the pipeline of gyrocompass cooling system.

### **3.6 LOG TRUNK AND/OR ECHO SOUNDER TRUNK**

**3.6.1** The log trunk and/or echo sounder trunk shall comply with the following requirements:

- .1** the size of the trunk shall be sufficient to allow the access to the converters;
- .2** the trunk shall be closed by a sliding door or have the manhole provided with a cover tightened with folding bolts. Control cock shall be fitted on the cover or on the coaming of the trunk;
- .3** for the purpose of descent, the trunk shall be provided with an ordinary or spar ladder;
- .4** the trunk shall be tested for tightness in compliance with the requirements of Appendix I "Testing procedures of watertight compartments", Part II "Hull" of the Rules for the Classification and Construction of Sea-Going Ships;
- .5** the trunk shall be provided with permanent electric lighting and a socket outlet for a portable electric lamp rated for a voltage of not more than 50 V.

**3.6.2** In oil tankers where the log and/or echo sounder trunks are located in way of cargo tanks, the following requirements shall be complied with (refer also to 3.7.4.6):

- .1** the trunk shall be separated from the cargo tanks by cofferdams;
- .2** feeding cables and wiring inside the space shall be laid in gastight steel pipes (refer also to 3.8.3 of the present Part and 2.2.2.9, Part XI "Electrical Equipment" of the Rules for the Classification and Construction of Sea-Going Ships);
- .3** effective ventilation of the space shall be provided;
- .4** the construction of the tightening gear of the manhole shall not be of spark-formation type.



### **3.7 ARRANGEMENT OF NAVIGATIONAL EQUIPMENT ON BOARD SHIP**

#### **3.7.1 Magnetic compass.**

**3.7.1.1** Magnetic compass shall be so installed and secured that its vertical plane which passes through the lubber lines will not deviate from the centre line of the ship or its parallel plane by more than  $0,2^\circ$ .

**3.7.1.2** The standard magnetic compass shall be installed on the upper bridge in an open place which shall provide for taking visual bearings over an arc of the horizon of  $360^\circ$ .

All-round free access to standard compass shall be provided.

On ships with gross tonnage less than 150 with no compass bridge, installation of the standard magnetic compass shall be provided as far as practicable and expedient.

**3.7.1.3** The place where the standard magnetic compass is installed and the main steering position shall be interconnected by means of a voice pipe or by any other means of two-way communication.

**3.7.1.4** The main and emergency steering positions shall be interconnected by telephone or other means of two-way communication.

**3.7.1.5** Any object in the vicinity of the standard magnetic compass, which was not provided in the original plan of the arrangement of the compass, may be fitted only if specially agreed with the Register (refer to 3.1.3).

**3.7.1.6** A master magnetic compass shall be installed aboard ship when the ship is equipped with the magnetic compass with electric remote transmission of dial readings, operating from a special sensitive element, if the latter cannot be used as a master compass.

**3.7.1.7** Special sensitive element of the magnetic compass with electric remote transmission of dial readings, which is not intended for use as a master compass shall be installed in ship in such a place where the effect of ship's magnetic fields is at its minimum and where the easy maintenance of the sensitive element by the navigator is ensured.

**3.7.1.8** The complete sets of magnetic compasses intended for installation in ships of non-restricted area of navigation shall include spare compensating magnets.

**3.7.1.9** Every ship shall be provided with the magnetic compass residual deviation table drawn up by a competent authorized body.

The Register fulfils no supervision functions of the procedure of timely and qualified determination and compensation of the deviation of magnetic compasses.

**3.7.1.10** A standard magnetic compass with optical remote transmission of dial readings shall be installed on board in compliance with the requirements specified in 3.7.1.1 to 3.7.1.5. In addition, the following requirements shall be complied with:

**.1** the periscope screen shall be preferably at eye level of a helmsman and at a distance not exceeding 1,2 m;

**.2** there shall be no dead angles of visibility in the periscope tube for a helmsman.

#### **3.7.2 Gyrocompass.**

**3.7.2.1** The compartment intended for installation of the master gyrocompass shall comply with the requirements of 3.5.

**3.7.2.2** It is allowed to install the master gyrocompass in the wheelhouse or in the chartroom, provided the overall dimensions of the master gyrocompass are not large.

**3.7.2.3** Free access to the master gyrocompass shall be provided. Easy and unhindered opening of lids and covers, as well as free access to terminal plates shall be provided.

**3.7.2.4** Bearing repeater shall be installed on the upper bridge, the requirements of 3.7.1.2 being strictly complied with, or one repeater shall be installed at each wing of the navigation bridge, thus providing for the field of view at least  $180^\circ$  right ahead on each side of the ship when taking bearings.

**3.7.2.5** Steering repeaters shall be installed at steering position of the ship. The location of steering repeaters shall provide for their convenient use by helmsman.

Where the wheelhouse is provided with the central control desk of the ship's heading and/or track control system with a built-in gyrocompass repeater, the installation of the separate steering gyrocompass repeater is not required.

If emergency rudder control station is provided on board the ship, gyrocompass repeater shall be fitted in close vicinity to it.

**3.7.2.6** The 0 — 180° lines of the master gyrocompass and bearing repeaters shall lie in the ship's centre line plane or parallel to it with an accuracy specified in 3.7.1.1.

**3.7.2.7** Power supply units and their starting and control apparatus shall be installed in the generator room, if any, or in the master gyrocompass compartment in a position which facilitates taking measurements of running speed of these units and maintenance of their bearings. Knobs for starting and remote control of the power supply unit shall be fitted in the same compartment where the master gyrocompass is installed or in the wheelhouse.

**3.7.2.8** It is allowed to install in ships both a gyrocompass and a magnetic compass with electric remote transmission of dial readings and to use the same repeaters for both compasses. In this case, a light signal "Repeaters switched to magnetic compass" shall be provided in the wheelhouse. This signal shall automatically be switched on when the repeaters are connected to the operation from the magnetic compass impulser.

**3.7.2.9** Water-cooled gyrocompasses the design of which provides for their normal functioning at the cooling water temperature up to 30 °C shall be supplied with cooling water from a special cooling arrangement installed on board.

**3.7.2.10** The requirements of 3.5.1.4 do not apply to ships of less than 300 gross tonnage. The compliance with requirements of 3.5.1.1 to 3.5.1.3 is recommended for such ships.

### **3.7.3 Log.**

**3.7.3.1** Primary speed transducers shall be installed in the bottom of the ship, preferably in the vicinity of the place of intersection of the base line and centre line of the ship in such a way that the transducers remain under water at the lightest draught of the ship and when the ship is rolling.

**3.7.3.2** No projecting parts of the hull, suction and discharge openings likely to affect the parallelism of stream lines washing the ship shall be located forward of the primary transducers.

**3.7.3.3** Electromagnetic transducers may be installed in sluice valves or they may be permanently fixed. Electromagnetic transducers shall be so installed that their longitudinal axes are parallel to the centre line of the ship with an accuracy not less than  $\pm 1^\circ$ .

**3.7.3.4** The sluice valves shall be fitted in a special trunk complying with the requirements of 3.6.

On the fishing vessels the primary speed transducers may be installed in the centre line box keel.

**3.7.3.5** Fixed electromagnetic transducers in the openings cut in the ship's bottom shall be adequately secured in the appropriate welded boxes being equivalent in strength to the ship's hull.

Ice protection of the Doppler log bottoms shall be equivalent in strength to or exceed the ship's hull structure in place of their installation.

**3.7.3.6** Speed and distance repeaters shall be installed in the place where the navigational plotting is performed.

Speed repeaters shall be installed in the wheelhouse and in the navigation bridge wings fitted with the steering posts of the main engine.

Where a main machinery control room is provided in the ship's engine room, installation of the speed repeaters in such control room is recommended.

**3.7.3.7** Where the combined indicators of the navigational information of television type are available in the navigation bridge, some speed and distance repeaters need not be installed in the bridge except for the speed repeater in the automatic remote control desk or in close proximity to it.

**3.7.4 Echo sounder.**

**3.7.4.1** The depth indicator shall be installed in the wheelhouse, and the depth recorder in the wheelhouse or in the chartroom, if any, in the place and at a distance providing their most convenient use and operation.

In certain cases, if agreed with the Register, it is allowed to install only one of these devices, it shall then be located in the wheelhouse.

**3.7.4.2** The vibrators of the echo sounder shall be installed in the ship's bottom clear of its sides and ends in places least affected by ship's vibration and at a distance which prevents them from being emerged out of water when the ship is rolling.

It is recommended to install the vibrator at a distance of 0,2 to 0,75 of the ship's length from the bow, as measured along the plane of the waterline, which corresponds to the lightest service draught of the ship and close to the centre line of the ship.

**3.7.4.3** In the vicinity of the vibrator there shall be no supersonic emitting devices of other instruments operating simultaneously with the echo sounder, as well as no projecting parts of the hull, discharge and suction openings, etc., which are likely to disturb the normal operation of echo sounders.

These requirements shall also be taken into consideration when portable vibrators are provided.

**3.7.4.4** Measures shall be taken to prevent corrosion of the ship's hull as a result of the installation of the vibrators.

**3.7.4.5** It is recommended to install vibrators in special spaces (trunks) (refer also to 3.6).

**3.7.4.6** It is allowed to install vibrators of echo sounders in cofferdams of cargo and oil fuel tanks, in double bottom tanks and in ventilated tunnels under cargo tanks of oil tankers, provided they are situated in a special gasproof recess, which is an integral part of the hull structure (refer also to 3.8.3 of the present Part and 2.2.2.9, Part XI "Electrical Equipment" of the Rules for the Classification and Construction of Sea-Going Ships). Feeding cables shall be mounted in gasproof steel pipes.

On the fishing vessels the vibrators of echo sounders may be installed in the centre line box keel.

The vibrators installed in the above spaces shall be of unattended design.

**3.7.4.7** The vibrators shall be so installed that their emitting and receiving surfaces are parallel to the horizontal plane and on one level when the ship is on even keel and is not inclined.

This requirement also applies to portable vibrators.

The deviation from the horizontal plane of not more than  $\pm 3^\circ$  is permissible for vibrators installed in bottom slot.

**3.7.4.8** The vibrators installed in bottom slots shall be so arranged that their emitting surface is on one level with the shell plating of the ship's hull. Where it is impossible to install the vibrators in horizontal plane due to the curvature of the ship's hull, it is recommended to use special stream-liners arranged in bow — stern direction.

**3.7.4.9** Additional strengthening measures shall be applied, where necessary, to increase the rigidity of the shell plating when the vibrators are installed in bottom slot.

**3.7.4.10** Where the vibrators are installed in a special tank, without slotting the ship's bottom, the tank shall be filled up with the liquid having acoustic characteristics as similar to those of sea water as possible.

**3.7.4.11** Special tanks intended for the installation of vibrators shall be, after the latter were fitted on board ships, tested for tightness in compliance with the requirements specified in Appendix 1 to Part II "Hull" of the Rules for the Classification and Construction of Sea-Going Ships.

**3.7.4.12** In no case shall the emitting surface of the vibrators be painted or subjected to any mechanical effects (shocks, hard friction, etc.). Ice protection of the echo sounder bottoms shall be equivalent in strength to or exceed the ship's hull structure in place of their installation.

**3.7.4.13** For the purpose of examining the cable boxes and checking the insulation of the vibrators free access to them shall be provided from the inside of the ship.

**3.7.4.14** Power supply equipment of the echo sounder (converters, transformers, etc.) shall be installed in the generator room or in a special recess located in the interior ship's compartments capable of being heated.

**3.7.5 Rate-of-turn indicator.**

**3.7.5.1** The main instrument of the rate-of-turn indicator shall be fitted on the rigid base in the generator room or in the equipment room in the vicinity of the wheelhouse. The upper surface of the base shall be parallel to the main (horizontal) plane of the ship.

It is allowed to install the main instrument in the wheelhouse provided the requirements of 3.1.3 and the permissible acoustic level are fulfilled.

**3.7.5.2** The repeaters of the rate-of-turn indicator shall be arranged in the wheelhouse in the vicinity of the steering station or in another place in the ship from which steering may be controlled, as well as on the wings of the navigation bridge.

**3.7.5.3** The instruments of the rate-of-turn indicator shall be arranged on the navigation bridge in such a way as to ensure convenient observation of the range scales and easy access to the controls.

**3.7.6 Radar.**

**3.7.6.1** The main radar display (means for presenting radar and additional navigation-related information) shall be installed near the navigation bridge forward bulkhead in such a way as not to impair visual observation ahead of the ship, along the ship's heading, and the display image shall not be impaired by any lighting conditions.

If an additional display is provided on board ship, it shall be installed near the place of performing navigational plotting.

If the radar control panel is a separate device, it shall be possible to monitor the radar equipment from all the work stations where radar displays and additional navigation-related information displays are installed.

**3.7.6.2** It is allowed to install the transmitter and other equipment of the radar on the bridge, provided the flux density of the power of high-frequency emissions, mechanical noise level and the level of electric interference to radio reception caused by this equipment do not exceed the permissible rates. Otherwise, the above-mentioned equipment shall be installed in a special enclosed and well-screened compartment or in the operating room.

**3.7.6.3** The diagrams indicating radar blind sectors shall be located near displays.

**3.7.6.4** If a second radar is provided on the ship, its display shall also be installed on the ship's navigation bridge.

In this case the main radar display shall be placed closer to the ship's starboard, and the second radar display — to portside.

**3.7.7 Bridge Navigational Watch Alarm System (BNWAS).**

**3.7.7.1** A Bridge Navigational Watch Alarm System (BNWAS) with a device intended for the BNWAS to return to its initial state shall be installed on the ship's navigation bridge in accordance with the requirements of the Rules for Bridge Design, Equipment, Arrangement and Procedures (refer to Appendix to this Part of the Rules).

**3.7.7.2** The device structure shall ensure that it can be used only by the watch-keeping officer on the ship's navigation bridge and shall be protected from accidental use by unauthorized persons.

**3.7.7.3** To facilitate ship's navigation and manoeuvring, a special "Emergency Call" key may be installed at the bridge workstation. The key is intended for immediate sounding, in case of necessity, an audible alarm signal of the second, and then, third level to call another watch-keeping officer and/or the master.

**3.7.8 Radar reflector.**

**3.7.8.1** The radar reflector shall be fitted either on a rigid mount or suspended on a proper rigging at places not shaded by the superstructures and other metal structures.

The height of installation shall be not less than that indicated in 5.8.2.

**3.7.8.2** For ships and floating facilities with gross tonnage less than 150 the maximum weight of radar reflector for mounting at 4 m shall not exceed 5 kg.

Radar reflectors designed for mounting at a height greater than 4 m shall be of respective weight recalculated pro rata. The overall dimensions of radar reflector shall be minimized and shall not exceed 0,05 m<sup>3</sup>.

**3.7.9 Universal automatic identification system.**

**3.7.9.1** The universal automatic identification system (AIS) equipment shall be so installed in the wheelhouse that the AIS display (if any) and the controls, and the radar, ARPA, and ECDIS displays, may be used readily, and to allow observation of the situation around the ship.

**3.7.9.2** Separate units comprising the universal automatic identification system which are not used frequently may be installed in the operating room or in a special enclosure in the vicinity of the wheelhouse.

**3.7.9.3** Output contacts of relay initiated at the detection of the AIS failure, shall be connected to the audible alarm device.

As the audible alarm device, a loud speaker integrated in the AIS equipment, an independent external alarm or alarm system located on the navigation bridge may be used.

**3.7.10 Radionavigation system receiver.**

The radionavigation system receiver indicator shall be installed in close proximity to the place where the navigational plotting is maintained.

**3.7.11 Combined ship control desk.**

**3.7.11.1** Combined ship control desks shall be arranged in the wheelhouse. In this case the requirements of 3.2 shall be met.

**3.7.11.2** Depending on the design of the combined ship control desk adopted in compliance with the requirements of 5.12.4, it shall be arranged in the wheelhouse symmetrically to the centre line, or parts or sections of the desks may be installed to the right or to the left from the centre line, provided the requirements of 5.12.13 are met.

**3.7.11.3** One of the steering gear remote controls shall be arranged in the centre line. Course and rudder blade indicators shall be so located that the possibility is provided for taking readings from any point of the wheelhouse.

**3.7.11.4** In addition to the manual controls for whistles provided by 5.12.2.6 and arranged in compliance with 5.12.13, provision shall be made for similar manual controls at the extreme sections of the desk in the wheelhouse and at the sections located on the wings of the navigation bridge (refer also to 4.6.2, Part III "Signal Means").

**3.7.12 Integrated navigation system.**

**3.7.12.1** Control panels of the navigational devices forming a part of the integrated navigation system, display units and input-output devices may be arranged in separate sections of the navigational desk.

**3.7.12.2** Integrated navigation system shall be installed in the wheelhouse or in the chartroom so that the operator can use the navigational equipment and keep a proper look-out.

**3.7.12.3** Separate kinds of navigational equipment forming a part of the integrated navigation system which do not require the constant observation and operational control may be installed in the equipment room or in specially enclosed compartment close to the wheelhouse (chartroom).

**3.7.13 Unified timing system.**

**3.7.13.1** The unified timing system station shall be installed on the navigation bridge in such location as to permit its easy maintenance.

**3.7.13.2** The controllable clock with the digital read-out provided for the service rooms shall be located in the wheelhouse and in the main machinery control room.

**3.7.14 Navigational instruments and appliances.**

The navigational equipment specified in Table 2.2.1, items 21 to 29, shall be arranged and stored in the places from which the steering control of the ship is effected (wheelhouse, chartroom).

**3.7.15 Radiobeacon station.**

Radiobeacon station the emissions of which are intended to enable a mobile station to determine its bearing or direction in relation to itself shall be installed in the space convenient for maintenance, in close proximity to aerial lead-in.

**3.7.16 Electronic chart display and information system (ECDIS).**

The electronic chart display and information system shall be installed in the wheelhouse so as to be convenient to use the system display and controls, radar and ARPA displays and observe the environment.

**3.7.17 Heading and/or track control system (autopilot).**

**3.7.17.1** The control panel of the regular manual steering system shall be connected with manual control panel of a mechanical or electrical transmission and shall be installed next to it.

**3.7.17.2** The combined manual and automatic control panel shall be installed on the navigation bridge in the centreline of the ship so as to provide easy maintenance and quick switching from automatic to manual control and vice versa.

The displacement of the control panel to the right of the centerline is allowed on ships where masts, cranes, other deck structures obscure visibility of the fore end. In this case special mark shall be provided in the fore end visible in the daytime and at night.

**3.7.17.3** The remote control panels of the system shall be installed on the bridge wings or in places convenient for their use.

**3.7.18 Sound reception system.**

**3.7.18.1** The receiving microphones shall be installed in such a way that the acoustic interference level from the ship's noise sources would be minimum.

**3.7.18.2** The system display shall be visible from the ship's main conning position.

**3.7.18.3** The system loudspeakers shall be installed so that incoming sound signals are audible at all positions of a wheelhouse.

**3.7.19 Voyage data recorder/simplified voyage data recorder.**

**3.7.19.1** The voyage data recorder/simplified voyage data recorder units are arranged on the ship's navigation bridge or in close proximity to it.

**3.7.19.2** The place where a special protected detachable container with the data carrier is installed shall be selected on the open deck in close proximity to the navigation bridge and centreline of the ship, as far as practical; thus, the necessity of its maintenance and its accessibility to the divers and remotely operated vehicles (ROV) in case of the ship flooding shall be considered.

The special protected float-free container of a simplified voyage data recorder shall be installed on the ship's open deck so as to ensure its free floating in any conditions of ship's sinking.

The long-term recording medium (refer to 5.20.4.3) shall be capable of being accessed from an internal, easily accessible area of the ship.

**3.7.19.3** Microphones of VDR/S-VDR positioned on the navigation bridge shall be so placed that conversation near the conning stations, radar displays/ARPA, chart tables are adequately recorded. The positioning of microphones shall also capture audible alarms as well as voice orders transmitted through the public address system, intercom systems.

**3.7.20 Weather station.**

**3.7.20.1** The ship weather station display unit shall be so installed in the wheelhouse that convenience of observation of hydro meteorological conditions and management of the weather station is provided.

**3.7.20.2** The weather station sensors shall be so installed on the open deck that the effect of the ship structures on the measured parameters is reduced to the minimum.

**3.7.21 Analog-digital signal converter.**

**3.7.21.1** Analog-digital signal converter shall be so installed that unrestricted access is provided for its setting and maintenance, and the requirements contained in the manufacturer's technical documentation are complied with.

**3.7.22 Digital signal multiplier.**

**3.7.22.1** Digital signal multiplier shall be installed in the wheelhouse in compliance with the requirements stipulated in the manufacturer's technical documentation.

### **3.8 CABLING**

**3.8.1** All outer cabling of the shipboard navigational equipment shall be made by means of screened cables and laid in compliance with the requirements of Part XI "Electrical Equipment" of the Rules for the Classification and Construction of Sea-Going Ships.

**3.8.2** Insulation resistance of every laid cable disconnected at both ends shall be not less than 20 M $\Omega$ , irrespective of the cable length.

**3.8.3** To eliminate electromagnetic interferences in the echo sounder diagram, the line transducer-receiver-amplifier shall be distant from the line vibrator-radiator by not less than 1 m from other electrical equipment and 0,5 m from the cables laid in parallel. Both lines shall be made by means of reliably screened cables. Cables running to the vibrators arranged in spaces below the bulkhead deck shall be laid in steel pipes.

**3.8.4** For radar installation all shielded cables and all shielded coaxial cables shall be laid in accordance with the technical specifications of the radar manufacturer, and the requirements of 3.8.1 shall be considered.

**3.8.4.1** To reduce the signal weakening, the cables shall be as short as possible.

**3.8.4.2** To minimize the electromagnetic interference effect, all cables between the antenna and other radar blocks shall be laid in runs which are as straight as possible and, if necessary, cross each other at right angle.

**3.8.4.3** No cables shall be laid near high voltage sources.

**3.8.4.4** To prevent moist from penetrating into the cables, all connections on the ship's open deck shall be of waterproof (IP56) type.

**3.8.4.5** When laying the cables and microwave transmitting feeders, minimum internal bending radii are to be maintained.

## **4 AERIALS AND EARTHING**

### **4.1 GENERAL**

**4.1.1** It is allowed to fit a ship with aerials of any type which provide the highest operational efficiency of the navigational equipment in accordance with its purpose.

**4.1.2** Aerials of the navigational equipment shall comply with the requirements of Section 4, Part IV "Radio Equipment".

**4.1.3** When choosing a location for installing aerials of the navigation equipment, one shall be guided by the provisions of 4.2 — 4.5, and appendices 5 and 6, unless otherwise provided by the manufacturer of the equipment.



## 4.2 RADAR AERIALS

**4.2.1** To ensure the maximum target location range and 360° observation, the radar antenna, if the ship's structure permits, shall be installed on a special mast.

The height at which the antenna is installed shall ensure the short range target location and minimize sea clutter and interference due to radiowaves reflection from the sea surface.

At the same time the height at which the antenna is installed shall be such that the flow density of its high frequency output signal at the ship's open decks where people can be present does not exceed the maximum permissible level.

**4.2.2** If scanning is effected straight ahead of the ship, it is admissible that the sea surface will not be scanned at a distance of not more than 500 m or double length of the vessel, whichever is shorter, for any type of cargo, ship's draught or trim.

Blind sectors shall be reduced to minimum and shall not be observed along an arch of horizon from straight ahead of the ship to the directions of 22,5° abaft the beam on each side of the ship.

Any two blind sectors separated from each other by an angle of 3° or smaller shall be regarded as one blind sector.

Separate blind sectors, the angle of which exceeds 5°, or the resultant arch of which exceeds 20° shall not be observed in the rest arch of horizon.

On the ships of unconventional design the requirements of this paragraph shall be met, as far as practicable and expedient.

**4.2.3** If two radars are installed on board, their antennas shall be installed in such a way as to minimize blind sectors and eliminate their mutual interference during their simultaneous operation.

**4.2.4** If two radar antennas are installed close to each other, the angle between them in the vertical plane shall be at least 20°, and the minimum distance between them in the vertical plane shall be at least 1 m.

**4.2.5** The radar antenna shall be installed in such a place on board where neither ship's structures nor deck cargo can reflect electromagnetic radiation.

**4.2.6** The radar antenna shall be installed far from the high frequency radiation sources and other transmitting/ receiving radio equipment antennas.

**4.2.7** If the antenna is installed on a special mast, the platform for its technical servicing and repairing shall have an area of at least 1 m<sup>2</sup> and shall be provided with protective rails which do not restrict the antenna rotation. The radar antenna lower edge shall be situated at least 500 mm higher than any rail of the platform.

In all cases it shall be possible to inspect and repair any part of the antenna.

The structure of the mast with the antenna platform shall be designed so as to take into consideration the vessel's operational conditions, possible vibration and impacts.

**4.2.8** If the antenna is installed at an easily accessible place, it shall be placed at least 1800 mm above the deck, ladder or any other place where people can be present.

**4.2.9** The radar antenna shall be installed at a safe distance from the ship's magnetic compass.

**4.2.10** All guys of the radar antenna mast shall be provided with insulators dividing the mast into unequal parts with lengths ranging from 2 to 6 m. If it is impossible to insulate the guys they shall be electrically bonded to the ship's hull.

### **4.3 AERIALS OF UNIVERSAL AUTOMATIC IDENTIFICATION SYSTEM (AIS)**

**4.3.1** The universal automatic identification system (AIS) aerials shall be installed at a maximum height so as to allow effective transmission and reception of signals at all operating frequencies, and to avoid obstructions to electromagnetic field propagation over the entire horizon as far as practicable.

The manufacturer's recommendations shall be taken into consideration.

#### **4.4 AERIALS OF RADIONAVIGATION SYSTEM RECEIVERS**

**4.4.1** Receiver antennas shall not be installed lower than ship's large-size metal structures and shall be situated at a distance of at least 3 m from any transmitting antennas.

**4.4.2** The antennas shall not be installed on the mast tops, at places subject to substantial vibration, under deck structures and rigging or near sources of heat or smoke.

**4.4.3** The position for a GNSS system receiver antennas shall be chosen so as to ensure unrestricted tracking of a satellite constellation signal and be situated at least 1m higher than other horizontal surfaces of the ship's structures.

**4.4.4** The GNSS receiver antennas shall not be installed along the axis of the main lobe of the radar antenna direction diagram, nor shall they be installed in the same plane with the INMARSAT Ship Earth Station antennas.

The distance between the above mentioned antennas shall be at least 10 m.

**4.4.5** If antennas are installed on small tonnage ships, the recommendations of the receiver Manufacturer are to be considered.

#### **4.5 SHIP WEATHER STATION SENSORS**

**4.5.1** Meteorological sensors or a combined weather station sensor shall be installed in the wind flow area not obstructed by the ship structures, on protruding parts of the highest superstructures on the ship's bow or on the mast, as close as possible to the ship centreline.

**4.5.2** Distance from the sensors (combined sensor) to funnels and ventilation system outlets shall be at least 10 m. When the sensors are mounted on the mast yards, the distance between the sensor and the mast shall be not less than three mast diameters if it is a solid structure and not less than two mast diameters if it is a framework structure.

#### **4.6 EARTHING**

**4.6.1** Navigational equipment installed in a ship shall have a protective earthing to the ship's hull which shall be made as short as possible.

**4.6.2** When leading in the cables into the equipment, their screened sheathings shall be electrically connected to the ship's hull.

**4.6.3** All radionavigational devices shall have the operational (high-frequency) earthing as well.

**4.6.4** The total resistance of all electric connections of any earthing shall not exceed 0,02 Ohm.

## **5 PERFORMANCE STANDARDS AND FUNCTIONAL REQUIREMENTS FOR NAVIGATIONAL EQUIPMENT**

### **5.1 GENERAL**

**5.1.1** Navigational equipment shall be in compliance with the requirements specified in IEC standard 60945:2002.

## 5.2 MAGNETIC COMPASS

**5.2.1** Magnetic compass shall be capable of indicating the ship's heading with the following accuracy:

$\pm 1^\circ$  — ship under way, no rolling;

$\pm 5^\circ$  — ship under way, rolling in all directions up to  $\pm 22,5^\circ$  with a period of 6 to 15 s.

**5.2.2** The compass card of the magnetic compass shall be capable of indicating the reading with accuracy up to  $0,5^\circ$ . Graduation division of the compass shall not exceed  $1^\circ$ .

**5.2.3** With the horizontal component of the Earth magnetic field  $H$ , in  $\mu\text{T}$ , at the point of compass installation and the temperature of ambient air  $+20 \pm 3^\circ\text{C}$ , the magnetic compass card stagnation shall not exceed  $(3/H)^\circ$  after deflecting the compass card from the magnetic meridian by  $\pm 2^\circ$ .

**5.2.4** The magnetic compass shall be provided with the relevant devices ensuring the compass card stability under the ship's vibrations and normal position of the compass bowl vertical axis under the ship's service conditions.

**5.2.5** The compass bowl with gimbal suspension shall retain horizontal position at the binnacle inclination to  $45^\circ$  in any direction. The card shall remain free at the bowl inclination in any direction of at least:

$10^\circ$  for compass with gimbal suspension;

$30^\circ$  for compass without gimbal suspension.

**5.2.6** The magnetic compass shall be provided with the devices for compensation of constant, semicircular, intercardinal, inclination and latitude deviation.

Where provision is made on board the ship for degaussing device, the magnetic compass shall be provided with a device for compensation of electromagnetic deviation.

Every such device shall be capable of compensating the corresponding deviation with accuracy up to  $\pm 0,2^\circ$ .

**5.2.7** The design of the devices specified in 5.2.6 shall provide for the compensation of deviation with maximum values of residual deviation not exceeding  $\pm 3^\circ$  for the standard magnetic compass and  $\pm 5^\circ$  for the spare one.

**5.2.8** The magnetic compass shall be provided with binnacles and electric lighting sufficient to make the scale divisions of the compass card distinctly visible. The lighting intensity shall be capable of being adjusted.

Electric lighting of the compass card of the magnetic compass shall be supplied from the main and emergency sources of electrical power.

Power supply from the emergency source of electrical power may be substituted for power supply from the accumulator battery.

**5.2.9** The height of the standard compass binnacle together with the pad it is installed on, shall provide for the plane of the compass bowl glass to be at the height of not less than 1300 mm from the deck.

The maximum height at which the compass may be installed is not restricted, but in any case, it shall not exceed the height providing for the most convenient operation of the compass.

**5.2.10** Standard compass shall be fitted with bearing finders which shall be capable of taking bearing of all visible landmarks, objects and heavenly bodies with reading accuracy of  $\pm 0,5^\circ$ .

Bearing finders of new type shall be capable of direct reading of bearings.

**5.2.11** The magnetic compass card or projection tube periscope shall be capable of ensuring accurate indication of readings at a distance of not less than 1,4 m both at day and artificial lighting. The use of magnifying devices is permitted.

**5.2.12** Magnetic compass with remote electric transmission of compass course shall comply with the requirements of 5.2.1 — 5.2.10. Besides, it shall be capable of transmitting the true course information to other navigational equipment and to repeaters (refer also to 5.10).

**5.2.13** Magnetic compass with remote electric transmission of compass course may consist of:

**.1** a magnetic compass, which does not require electrical power supply to operate the sensing part and is provided with the device for remote electric transmission of compass course.

In case the remote electric transmission of compass course meets the requirements in 5.10, such compass may be used as a standard magnetic compass;

**.2** an electromagnetic compass which requires electrical power supply to operate the sensing part and provided with an electronic device to generate the corrected compass course and transmit it to other navigational equipment.

This compass may be used on board as a magnetic compass additional to the standard one.

**5.2.14** Magnetic compass shall be provided with devices for compensation of deviation within the following limits:

**.1** the vertical component of the ship's magnetic field at the point of compass installation, including the inclination deviation: up to  $\pm 75 \mu\text{T}$ ;

**.2** coefficient *A*: up to  $\pm 3^\circ$ ;

**.3** coefficient *B*: up to  $\pm (720/H)^\circ$ ;

**.4** coefficient *C*: up to  $\pm (720/H)^\circ$ ;

**.5** coefficient *D*: up to  $\pm 7^\circ$ ;

**.6** coefficient *E*: up to  $\pm 3^\circ$ ,

where *H* is the horizontal component of the Earth magnetic field at the point of compass installation, in  $\mu\text{T}$ .

The set positions of controllers of the electronic devices for compensation of deviation shall be clearly marked and constantly active.

The device for compensation of deviation shall be protected against unauthorized access.

Magnetic compass with remote electric transmission of compass course shall have one output channel as a minimum to transmit the course to other navigational equipment in accordance with the requirements of IEC 61162.

**5.2.15** Magnetic compass with remote transmission of compass course shall remain capable of normal operation under the following variations of the ship's movement:

circulation with angular speed up to  $6^\circ/\text{s}$ ;

yawing with period of 10 to 20 s and maximum course deviation by  $\pm 5^\circ$ .

**5.2.16** The design of the magnetic compass fitted with optical remote transmission of the card readings shall provide for the screen to present the direct reflected image of the card dial sector with clearly visible divisions of degrees on the arc of not less than  $30^\circ$  as well as the lubber's line fitted in the casing of the compass bowl.

It is recommended that a device capable of presenting the card dial image from fore and aft sides of the periscope shall be provided.

**5.2.17** The length of the projection tube periscope of the magnetic compass fitted with optical remote transmission of card readings shall provide for the possibility of fitting the screen at eye-level of the helmsman, the height of the compass pad and passage of the periscope tube through the deck being taken into account.

The height of the screen shall be capable of being regulated by 100 to 150 mm up and down from the mean position.

**5.2.18** The screen shall be provided with a device protecting it from bright sunshine or other source of light capable of distorting the image on the compass card screen by floodlighting. The image shall be distinctly visible on the screen by day and by night.

**5.2.19** The design of the optical system shall provide for the image of dial sector to remain distinct and clear both during visual bearing taking and with the compass cap closed.

**5.2.20** A suitable device for adjusting and fixing of the screen position shall be provided.

**5.2.21** The enclosure of optical system shall be of waterproof IP56 design. Adequate measures shall be taken to prevent sweating and condensation of moisture in the enclosure. The easy access shall be provided to the optical system for the purpose of its maintenance.



**5.2.22** The lifeboat magnetic compass shall comply with the following requirements:

- .1 graduation division of compass card shall be  $1^\circ$ ,  $2^\circ$  but shall not exceed  $5^\circ$ , depending on the diameter of the compass card;
- .2 under conditions specified in 5.2.3, the compass card stagnation shall not exceed  $(9/H)^\circ$ ;
- .3 provision shall be made for lighting of the compass card in accordance with the requirements of 6.13.8.1.5, Part II "Life-Saving Appliances";
- .4 fastening gear for securing the compass in the lifeboat and a box for storing the compass shall be provided;
- .5 the diameter of the compass card shall be sufficient to provide normal taking of readings.

### 5.3 GYROCOMPASS

**5.3.1** The gyrocompass positioned on a horizontal and stationary base in latitudes of up to 60° shall conform to the following requirements:

.1 the gyrocompass shall be brought into alignment with meridian within 6 h;

.2 the steady state error at any course shall not exceed  $\pm 0,75^\circ \times \text{secant latitude}$  and the root mean square value of the differences between individual course indications and the mean shall be less than  $0,25^\circ \times \text{secant latitude}$ ;

.3 the permissible error from one run-up to another shall be within  $\pm 0,25^\circ \times \text{secant latitude}$ ;

.4 follow-up system performance speed shall be not less than 6°/s.

**5.3.2** The gyrocompass mounted on board ship under operational conditions in latitudes up to 60° shall conform to the following requirements:

.1 under rolling and pitching harmonic motions of up to 5° with a period of 6 to 15 s at maximum acceleration of 0,22 m/s<sup>2</sup> the gyrocompass shall be brought into alignment with meridian within 6 h;

.2 the error of the master compass readings under service conditions, due to variations in ship's power supply parameters and possible alterations of magnetic fields shall not exceed  $\pm 1^\circ \times \text{secant geographical latitude}$ ;

.3 the error of readings due to a rapid alteration of ship's speed of 20 knots shall not exceed  $\pm 2^\circ$ ;

.4 the error of readings due to a rapid alteration of course of 180° at a speed of up to 20 knots shall not exceed  $\pm 3^\circ$ ;

.5 the residual error at a straight course (after correction for speed and course and, if necessary, latitude influences) at a steady speed of up to 20 knots shall not exceed  $\pm 0,25^\circ \times \text{secant latitude}$ ;

.6 errors of readings due to rolling up to 20 °C, pitching up to 10° and yawing up to 5° with a period 6 to 15 s and the maximum horizontal accelerations not more than 1 m/s<sup>2</sup> shall not exceed  $1^\circ \times \text{secant latitude}$ ;

.7 the divergence in readings between the master compass and repeaters shall not exceed  $\pm 0,5^\circ$ .

*Note.* The errors specified in 5.3.2.3 to 5.3.2.6 are taken to be the difference between the observed and the settle point heading values.

**5.3.3** The complete set of gyrocompass shall be provided with a course recorder and also a corrector used for correction of compass readings in respect to ship's speed and latitude.

**5.3.4** It is advisable to provide a course recording device (a course recorder), capable of recording ship's course in respect of time with accuracy of  $\pm 1^\circ$  in the complete set of gyrocompass.

**5.3.5** The system of gyrocompass readings remote transfer shall be so designed as to ensure simultaneous operation of gyrocompass repeaters, fitted in other navigational equipment, the course recorder (when it is available), as well as transmission of information on the course to other navigational equipment.

**5.3.6** The design of repeater cards, bearing taking devices, lighting fittings and other arrangements shall be capable of ensuring the indication of course and bearing readings in compliance with the requirements of 5.2.2, 5.2.4, 5.2.8 (except for the requirements as regards the reserve self-contained source of lighting, kind of electric current and voltage), 5.2.9 and 5.2.10.

## 5.4 LOG

**5.4.1** Devices to indicate speed and distance (log) are intended for generating and displaying the ship's motion parameters data used for general navigation and ship manoeuvring.

As a compulsory parameter, the log shall be capable of measuring the longitudinal speed component of ship's motion forward speed through water or over the ground as well as the distance run in that direction. Additionally, the log may also measure the other components of ship's motion.

A log transmitting information about the ship's speed to a radar plotting aid (EPA, ATA, ARPA) and to the ship's track control system, shall be capable of measuring the ship's speed through the water in the fore direction.

**5.4.2** The log shall normally function at forward speeds up to the maximum and in water beneath the keel of depth greater than the following values:

3 m for speed and distance measuring devices through the water;

2 m for speed and distance measuring devices over the ground.

**5.4.3** Initial sensitivity of a log shall not be more than 0,1 knot.

**5.4.4** Provided the ship is operating free from shallow effect and from the effects of wind, current and tides, in measuring the ship speed by the log, the error ( $3\sigma$ ) shall not exceed, at normal probability law, the following values:

$\pm 2$  % of the actual speed of the ship, or  $\pm 0,2$  knots, whichever is greater, for a digital display and for output data transmission;

$\pm 2,5$  % of the actual speed of the ship, or  $\pm 0,25$  knots, whichever is greater, for an analogue display.

**5.4.5** In measuring the distance run through the water, the error shall not exceed  $\pm 2$  % of the actual distance run by the ship in one hour or  $\pm 0,2$  miles in each hour, whichever is greater, provided the ship is operating free from shallow effect and from the effects of wind, current and tides.

**5.4.6** The divergence in readings of speed repeaters and the main unit shall not exceed  $\pm 1,5$  % of the upper limit of the measuring range of the log.

The divergence in readings of distance repeaters and the main unit shall not exceed  $\pm 0,01$  of a mile and that of repeaters,  $\pm 0,02$  of a mile.

The distance repeaters and speed repeaters shall be capable of operating simultaneously.

Speed repeaters shall be of self-synchronized type. It is permitted to use digital display as speed repeaters. In this case, the direction of ship's movement shall be indicated unambiguously.

**5.4.7** The logs shall comply with the following design requirements:

**.1** the submerged retractable mechanism of logs shall provide for their quick setting in operation position and retracting inside the ship's hull by one person only;

**.2** log components structure shall be so designed that neither the method of their attachment to the ship's hull, nor the preventive inspection and replacement on the ship afloat, nor damage to any part of the equipment penetrating the hull could result in the disturbance of the longitudinal strength of the ship's hull and in the ingress of water to the ship;

**.3** where the mass of the retractable submerged mechanism exceeds 16 kg, a mechanical gear (winches, tackles, blocks) for lifting the movable parts inside the hull shall be provided. The time required for retracting shall not exceed 2 min.

Provision shall be made for a device for remote setting in operation position and retracting inside the hull of the submerged part of the log, the device being operated from the wheelhouse. In this case, adequate limit switches capable of restricting the lowering and retracting of the sliding tube, sealing in the sluice valves and a visual signal in the wheelhouse indicating the "lifted" or "lowered" position of the sliding tube as well as "sluice valve closed", if this is required by the design of the log, shall be provided;

**.4** materials used for making the submerged parts of logs, their finishing and coating shall ensure longtime operation of the log in sea water;

.5 provision shall be made in the complete set of a log for a necessary number of speed and distance repeaters as required by 3.7.3.6 and 3.7.3.7.

The distance and speed repeaters may be incorporated in one common casing;

.6 logs shall be fitted with devices for adequate adjustments after the installation of these logs on board, as well as for the compensation of the inadmissible errors in log readings;

.7 speed information may be presented in analogue or digital form, or in both forms at the same time.

Where a digital is used, its incremental steps shall not exceed 0,1 knots at data renewal frequency once per second.

An analogue display shall be graduated at least every 0,5 knots and be marked with figures no greater than every 5 knots.

If the display is intended to present the ship's motion different components, the direction of movement shall be indicated unambiguously;

.8 distance run information shall be presented in the digital form. The display shall cover the range from 0 to not less than 9999,9 miles and the incremental steps shall not exceed 0,1 miles. On-line counter may be provided for resetting a read out to zero;

.9 the graduation dials of the main unit and repeaters shall be provided with interior adjustable lighting.

The display shall be easily readable by day and night;

.10 the interconnection of the repeaters shall be effected through appropriate fuses;

.11 it is recommended to provide logs with a signalling system capable of monitoring running by the ship of certain predetermined distances;

.12 it is permitted to use the transducers of logs both of sliding and fixed design.

Sliding and fixed transducers may protrude from the bottom or may be in flush position to the bottom of the ship;

.13 two primary electromagnetic transducers with appropriate changing-over device are permitted to be installed.

**5.4.8** The log translating device shall provide feeding distance run information to other equipment fitted on board. In this regard if the relay contact is used, the information shall be fed to external systems only for forward ship's movement. The information shall be in the form of one contact closure (or its electrical equivalent) for each 0,005 miles run. The minimum time of contact closure or duration of the equivalent impulse signal shall be at least 50 ms.

If the log is intended for feeding external systems with the information on speed, distance run and also on other ship's movement parameters, including directions, its translating device shall be provided with sufficient number of serial digital interfaces (also refer to IEC 61162).

**5.4.9** If the log is capable of being operated in the speed through water and speed over the ground modes, mode selection and mode indication shall be provided.

If the two-component log has provision for indicating the longitudinal and transverse speed components, the unambiguous and clear indication of the operation mode and displayed parameters shall be provided.

As an additional option, the log display may provide information on the resultant speed vector (as to module and direction) of ship's movement at the place of a transducer location and also the calculated data of bow and stern motion parameters.

**5.4.10** The primary electromagnetic transducers of the logs shall not produce interference to operation of other navigational equipment of the ship.

**5.4.11** The log performance shall not deteriorate when the ship is rolling up to  $\pm 10^\circ$  and pitching up to  $\pm 5^\circ$ .

**5.4.12** If the log performance is affected by certain conditions (sea state and its effects, water temperature, water salinity and aeration, sound velocity in water, the depth of water under the keel, heel, trim and draught of ship), details of possible effects shall be included in the ship's technical documentation.

## 5.5 ECHO SOUNDER

**5.5.1** The echo sounder is intended for reliable measuring, visual presentation, recording and transmitting information on the depth of water under a ship to other ship's systems. The echo sounder shall function at all headway ship speeds from 0 up to 30 knots under conditions of heavy water aeration, of brash, broken ice and in areas with a sharp change of the bottom contour, with the rocky, sandy and muddy bottom.

**5.5.2** The echo sounder shall be capable of measuring any clearance under the transducer between 1 m and 200 m.

**5.5.3** The echo sounder shall be provided with:

- .1 shallow range scale covering 0,1 of the depth range (1 to 20 m);
- .2 deep range scale covering the whole depth range (1 to 200 m).

The pulse repetition rate shall not be slower than 36 pulses per minute on the shallow range and 12 pulses per minute on the deep range.

**5.5.4** Based on a sound speed in water of  $C=1500$  m/s, the tolerance of the indicated depth shall not exceed:

- .1  $\pm 0,5$  m on the shallow range scale or  $\pm 2,5$  % of the indicated depth, whichever is greater;
- .2  $\pm 5,0$  m on the deep range scale or  $\pm 2,5$  % of the indicated depth, whichever is greater.

The echo sounder performance shall not deteriorate when the ship is rolling  $\pm 10^\circ$  and pitching  $\pm 5^\circ$ .

Some omissions in readings are permissible when the ship is rolling more than  $10^\circ$  and/or pitching more than  $5^\circ$ , the sea bed has rocky or steeply sloping character (over  $15^\circ$ ).

**5.5.5** The complete set of the echo sounder shall include one or more transducers, the main unit with built-in depth indicator, a depth recording device, remote repeaters and also the translating device for data transmitting to other ship's systems.

The echo sounder design shall provide for a possibility of displaying the immediate depth on the depth indicator and of recording the sounded depth in the depth recording device.

The depth recording device may be built into the echo sounder main unit.

**5.5.6** More than one transducer fitted in different parts of the ship may be used in the echo sounder composition. In doing so, a clear indication of the transducer(s) in use shall be provided.

**5.5.7** The echo sounder design shall simultaneously provide the presentation of depth information:

- .1 in the graphical form displaying the depth profile along the ship's run;
- .2 in the digital form displaying the immediate depth.

The graphical form of depth information display shall provide a visible record of soundings during at least 15 min.

**5.5.8** The scale of depth display in a graphical form shall be not smaller than:

- .1 1 m: 5,0 mm per metre depth on the shallow range scale;
- .2 1 m: 0,5 mm per metre depth on the deep range scale.

The graphical display shall be capable of automatic showing time marks at intervals not exceeding 5 min, and depth marks at intervals not larger than one-tenth of the range of a scale in use.

The indications of digital depth indicators shall be multiples to 0,1 m.

Other forms of depth information display may be used if they do not affect the reliability of graphical and digital information.

**5.5.9** The echo sounder shall be provided with audible and visual alarm signals on ship's approach to the preset depth. Manual setting of the preset depth in the depth range from 1 m up to 100 m shall be continuous or in steps (5, 50, 100 m).

**5.5.10** The echo sounder shall be provided with a device to allow a correction for determination of a depth under the most immersed part of the ship.

**5.5.11** The echo sounder shall be provided with audible and visual alarms to indicate failures, affecting a reliability of information displayed, and also an interruption of power supply and the critical change of ship's mains parameters.

**5.5.12** The echo sounder depth recording device shall provide recording of information about depth with time marks during previous 12 h. Moreover there shall be means for the shore-based retrieval of recorded information.

**5.5.13** Recording of echo sounder indications may be carried out on the paper tape or other media.

If paper tape is used, the relevant marks shall be provided on its right side indicating when the paper remaining is less than 1 m.

**5.5.14** Switching on of the echo sounder shall be effected by one manipulation.

The starting period shall not exceed 30 s.

**5.5.15** Sounding in shoal water may be effected by an individual echo sounder installed on board the ship which is capable of measuring on the shoal water range scale and not less than on the half of the shallow water range scale.

## 5.6 RATE-OF-TURN INDICATORS

**5.6.1** The rate-of-turn indicator shall operate independently of gyrocompass and radar operation and shall be capable of indicating the direction and angular speed of the ships turn.

**5.6.2** The rate-of-turn indicator shall be so constructed as to operate both with the automatic and manual ship steering.

**5.6.3** With due regard for the influence of earth rate the indicated rate of turn shall not deviate from the actual rate of turn of the ship by more than  $0,5^\circ/\text{min} + 5\%$  of measured value.

The rate-of-turn indicator shall meet these accuracy requirements at ship's speed up to 10 knots.

**5.6.4** Yawing of the ship at sea shall not change reliable operation of the rate-of-turn indicator on waves.

Periodic rolling motion of the ship with an amplitude of  $\pm 5^\circ$  and period of up to 25 s and periodic pitching motion with an amplitude of  $\pm 1^\circ$  and period of up to 20 s shall not change the mean value of the indicated rate of turn by more than  $0,5^\circ/\text{min}$ .

**5.6.5** The rate-of-turn indicator shall be ready for operation and shall meet the requirements of the present Chapter within 4 min of being switched on. Its operation shall be indicated on the display.

**5.6.6** The number of repeaters of the rate-of-turn indicator shall meet the requirements of 3.7.5.2.

**5.6.7** The rate of turn shall be indicated by a centre-zero analogue type indicator (preferably circular). Where a circular scale indicator is used, the zero shall be uppermost. Alphanumeric display may be permitted. In this case, positive indication of port and starboard shall be provided.

**5.6.8** A turn of ship to port shall be indicated on the left of the zero point and a starboard turn to the right of the zero point. If the actual rate of turn exceeds full scale deflection, this shall be clearly indicated on the display.

**5.6.9** The length of scale in either direction from zero shall not be less than 120 mm. The sensitivity of the system shall ensure that a change in the rate of turn of  $1^\circ/\text{min}$  is represented by a distance of not less than 4 mm on its scale.

**5.6.10** A linear range scale of not less than  $\pm 30^\circ/\text{min}$  shall be provided. This scale shall be marked in intervals of  $1^\circ/\text{min}$  on both sides of zero and with figures every  $10^\circ/\text{min}$ . Every  $10^\circ/\text{min}$  mark shall be significantly longer than the  $5^\circ/\text{min}$  mark which in turn shall be significantly longer than the  $1^\circ/\text{min}$  mark. The marks and figures shall preferably be red or light colour on a dark background. Additional linear range scales may be provided.

**5.6.11** Damping of the rate-of-turn indicator shall be provided with a time constant which may be varied during operation in the range zero to at least 10 s.

**5.7 RADAR**

**5.7.1** The radar equipment shall assist in avoiding collision and safe navigation by providing a detection and indication of the positions of other ships, shoreline, buoys, surface objects and obstructions as well as navigation marks.

- The radar shall perform the following functions:
- display of radar video;
- indication of position and target tracking information;
- positional data derived from own ship's position (EPFS);
- display of AIS target information.

It is recommended to provide the capability of displaying data of system Electronic Navigation Charts for monitoring own ship's position.

**5.7.2** Regardless of the type of ship on which the radar will be installed, frequency band used and indication device type the radar shall meet the requirements specified in Table 5.7.2.

Table 5.7.2

Gross tonnage of ship	< 500	500 up to < 10000	≥ 10000
Minimum operational display area diameter, mm	180	250	320
Minimum display area	195 × 195	270 × 270	340 × 340
Auto acquisition of targets	—	—	+
Minimum acquired radar target capacity	20	30	40
Minimum activated AIS target capacity	20	30	40
Minimum sleeping AIS target capacity	100	150	200
Trial Manoeuvre	—	—	+

**5.7.3** The radar shall ensure operation in the following frequency bands:

X-band: 9,2 to 9,5 GHz (wave length of 3 cm) for high discrimination, good sensitivity with no clutter;

S-band: 2,9 to 3,1 GHz (wave length of 10 cm) to ensure that target detection and tracking capabilities are maintained in adverse conditions of fog, rain and sea clutter.

The frequency band in use shall be clearly indicated.

**5.7.4** The radar shall be capable of operating satisfactorily in typical interference conditions and of measuring the following parameters:

- range within 30 m or 1 % of the range scale in use, whichever is greater;
- bearing within 1°.

**5.7.5** The capability of the radar of indicating the target in at least 8 out of 10 scans with a probability of radar detection false alarm not more than  $10^{-4}$  shall be determined in the process of the aerial operation within "X-band" (3 cm) and "S-band" (10 cm) under the following conditions:

- absence of clutter;
- aerial height of 15 m above sea level.

The minimum detection ranges for various targets in clutter-free conditions are specified in Table 5.7.5. Minimum range target detection shall be achieved with the use of a regular aerial having the smallest aperture.

**5.7.6** With own ship at the zero speed, absence of clutter, in calm conditions, an aerial height of 15 m above sea level the navigation buoy specified in Table 5.7.5 shall be detected at a minimum horizontal range of 40 m from the aerial position and up to a range of 1 mile, without the setting of control functions other than the range scale selector.

Compensation for any range error shall be automatically applied for each selected aerial, where multiple aerials are installed.



Table 5.7.5

Minimum detection ranges

Target description <sup>1</sup>	Target feature, height above sea level, m	Detection range in NM <sup>2</sup>	
		X-band 3cm	S-band 10cm
Shorelines	Rising to 60 m	20	20
Shorelines	Rising to 6 m	8	8
Shorelines	Rising to 3m	6	6
Ships of > 5000 gross tonnage	10	11	11
Ships of > 500 gross tonnage	5	8	8
Small vessel with radar reflector <sup>3</sup>	4	5	3,7
Navigation buoy with corner reflector <sup>4</sup>	3,5	4,9	3,6
Navigation buoy <sup>5</sup>	3,5	4,6	3,0
Small vessel of length 10m with no radar reflector <sup>6</sup>	2,0	3,4	3,0

<sup>1</sup> Reflectors are taken as point targets, vessels as complex targets and shorelines as distributed targets (typical values for a rocky shoreline, but are dependent on profile).

<sup>2</sup> Detection ranges may be changed by various factors, including atmospheric conditions, target speed and aspect, target material and target structure.

<sup>3</sup> The Radar Cross Section (RCS) for the radar reflector shall be: 7,5 m<sup>2</sup> for X-band, 0,5 m<sup>2</sup> for S-band.

<sup>4</sup> RCS for the corner reflector shall be: 10 m<sup>2</sup> for X-band and 1 m<sup>2</sup> for S-band.

<sup>5</sup> The navigation buoy shall have RCS of 5 m<sup>2</sup> for X-band and 0,5 m<sup>2</sup> for S-band.

For the channel markers with an RCS of 1,0 m<sup>2</sup> (X-band) and 0,1 m<sup>2</sup> (S-band) and height of 1 m their detection range shall be of 2,0 and 1,0 miles respectively.

<sup>6</sup> RCS for 10 m small vessel shall be of 2,5 m<sup>2</sup> for X-band and 1,4 m<sup>2</sup> for S-band.

**5.7.7** The radar shall provide consistent target detection performance on all the working range scales under sleeping clutter conditions.

The radar system shall provide the means to enhance the visibility of targets in adverse sleeping clutter conditions at close range.

Degradation of detection performance (related to the figures in Table 5.7.5) under the following conditions, shall be clearly stated in the technical documentation;

- light rain (4 mm per hour) and heavy rain (16 mm per hour);
- sea state 2 and sea state 5;
- and a combination of these.

Possible degradation in performance due to a long transmission line, actual aerial height or any other factors shall be clearly stated in the technical documentation.

**5.7.8** Means shall be provided in the radar design for the adequate reduction of unwanted echoes, including sea clutter, rain and other forms of precipitation, clouds, sandstorms and interference from other radars.

Effective manual and automatic anti-clutter functions shall be provided. A combination of automatic and manual anti-clutter functions is permitted.

A gain control function shall be provided to set smoothly the system gain and signal threshold level. There shall be clear indication on the radar display of the level for gain and all anti-clutter functions.

**5.7.9** Means shall be available in the radar design to enhance target presentation on the display.

The picture shall be updated in smooth and continuous manner with minimum latency.

The technical documentation shall explain the basic concept, features and limitations of any signal processing.

**5.7.10** The X-band radar system shall be capable of detecting radar beacons, SARTs in the relevant frequency band.

It shall be possible to switch off those signal processing functions, including polarization modes, which may prevent a X-band radar beacon or SART from being detected.

The status of the signal processing mode used shall be indicated.

**5.7.11** Range and bearing discrimination shall be measured in calm conditions, on the range scale of 1,5 miles or less and at between 50 % and 100 % of the range scale selected. In so doing the following requirements shall be met:

the radar system shall be capable of displaying two point targets on the same bearing, separated by 40 m or more in range, as two distinct objects;

the radar system shall be capable of displaying two point targets at the same range, separated by  $2,5^\circ$  in bearing, as two distinct objects.

**5.7.12** The target detection performance of equipment shall not be impaired when own ship is rolling or pitching up to  $\pm 10^\circ$ .

**5.7.13** Means shall be available in the radar to monitor performance of the radar system. In the absence of targets, the possibility of monitoring the performance of the radar system shall be retained.

Where applicable to radar technology, manual tuning shall be provided and, additionally, automatic tuning may be provided.

Means shall be available in the radar to determine a significant drop in system performance relative to a calibrated standard established at the time of installation.

**5.7.14** The radar equipment shall be fully operational (RUN status) within 4 min after switch on from cold.

A STANDBY condition shall be provided, in which there is no operational radar transmission. The radar shall be fully operational within 5 sec from the standby condition.

**5.7.15** Measurements from own ship (e.g. target range, variable range markers, target bearing, cursor, tracking data) shall be made with respect to the consistent common reference point of the own ship (e.g. conning position). Facilities shall be provided to compensate for the offset between the aerial position and the consistent common reference point on installation.

Where multiple aerials are installed, there shall be provision for applying different position offsets for each aerial in the radar system. The offsets shall be applied automatically.

Own ship's scaled outline shall be available on lower range scales. The consistent common reference point and the position of the selected radar aerial from which information is derived shall be indicated on this graphic.

Picture on the radar display shall be centred with respect to the consistent common reference point which shall be at the centre of the bearing scale.

Range measurements shall be in miles. In addition, facilities for metric measurements may be provided on lower range scales. All indicated values for range measurement shall be unambiguous.

Radar targets shall be displayed on a linear range scale and without delay in the display when the target position changes.

**5.7.16** Range scales of 0,25; 0,5; 0,75; 1,5; 3; 6; 12 and 24 miles shall be provided. Additional range scales, including large-sized metric range scales, are permitted outside the mandatory set.

The range scale selected shall be permanently indicated.

**5.7.17** An appropriate number of equally spaced fixed range rings shall be indicated on the radar display. The interval between the fixed range rings shall be continuously presented on the radar display.

The system accuracy of fixed range rings shall be within 1 % of the maximum range of the range scale in use or 30 m, whichever is the greater distance.

**5.7.18** At least two variable range markers shall be provided, each variable range marker shall have a numerical readout.

The variable range marker shall enable the user to measure the range of an object with maximum system error of 1 % of the range scale in use or 30 m, whichever is the greater distance.

**5.7.19** A bearing scale around the periphery of the operational display area shall be provided. The bearing scale shall indicate the bearing as seen from the consistent common reference point of the own ship.

The bearing scale shall be numbered at least every  $30^\circ$  division and have division marks of  $5^\circ$  and  $10^\circ$  which shall be clearly distinguishable from each other.  $1^\circ$  division marks may be presented where they are clearly distinguishable from each other.

**5.7.20** An electronic graphic line from the consistent common reference point to the bearing scale shall indicate the heading of the ship. Means shall be provided to align the electronic heading line to within  $0,1^\circ$ .

If there is more than one radar aerial, the heading skew (bearing offset) shall be retained and automatically applied when each radar aerial is selected.

Provision shall be made to temporarily suppress the image of the heading line by the use of a switch with automatic reset to "on" position. This function may be combined with the suppression of other graphics.

**5.7.21** At least two electronic bearing lines (EBLs) shall be provided to measure the bearing of any point object with a maximum system error of 1 at the periphery of the display.

The EBLs shall be capable of measurement relative to ship's heading and relative to true north. There shall be a clear indication of the bearing reference (i.e. true or relative).

It shall be possible to move the EBL origin from the consistent common reference point to any point of the operational display area and to reset the EBL to the consistent common reference point by a fast and simple action.

It shall be possible to fix the EBL origin at any point of the display or to move the EBL origin at the velocity of own ship.

Means shall be provided to ensure that the user is able to position the EBL smoothly in either direction and to maintain the appropriate system measurement accuracy requirements.

Each EBL shall have a numerical readout with a resolution adequate to maintain the system measurement accuracy requirements.

**5.7.22** A minimum of four independent parallel index lines, with a means to truncate and switch off each individual line shall be provided. Means of setting the bearing and beam range of the parallel index lines shall be provided.

**5.7.23** There shall be a means to measure the range and bearing of one position on the display relative to any other position on the operational display area.

**5.7.24** A user cursor shall be provided to enable designation of any position on the operational display area. The cursor position shall have a continuous readout to provide the range and bearing, measured from the consistent common reference point, and/or the latitude and longitude of the cursor position presented either alternatively or simultaneously.

The cursor shall provide a means to select and deselect targets, graphics within the operational display area. In addition, the cursor may be used to select modes, functions, vary parameters and control menus outside the operational display area.

Means shall be provided to easily locate the cursor position on the display.

The accuracy of the range and bearing measurements provided by the cursor shall meet the relevant requirements for VRM and EBL.

**5.7.25** The own ship's heading information shall be provided by a gyrocompass.

The accuracy of azimuth alignment of the radar presentation shall be within 0,5° with a rate of turn likely to be experienced with the class of ship.

The own ship's heading information shall be referenced to the consistent common reference point and displayed with a numerical resolution to permit accurate alignment with the gyro system.

**5.7.26** A True Motion display mode shall be provided having regard to the motion parameters of the own ship. The automatic reset of own ship may be initiated by its position on the display, or time related, or both.

The reset shall be selected to occur at least on every scan.

North Up and Course Up orientation modes shall be provided.

A clear and continuous indication of the motion and orientation mode shall be provided.

**5.7.27** Manual off-centring shall be provided to locate the selected aerial position at any point within at least 0,5 of the radius from the centre of the operational display area.

On selection of off-centred display, the selected aerial position shall be capable of being located to any point on the display within 0,75 of the radius from the centre of the operational display area.

In True Motion, the selected aerial position shall automatically reset to a location giving the maximum view along own ship's course. Provision for an early reset of selected aerial position shall be provided.

**5.7.28** Two modes of display and graphics stabilization: ground and sea stabilization modes shall be provided.

The stabilization mode in use and information on information sensor enabling implementation of the selected mode shall be clearly indicated.

**5.7.29** Variable length (time) target trails (afterglow) shall be provided with an indication of trail time and mode.

It shall be possible to select true or relative trails.

The trails shall be distinguishable from targets.

Either scaled trails or past positions or both, shall be maintained and available for presentation within 2 scans, following:

- the reduction of increase of one range scale;
- the offset and reset of the radar picture position; and
- a change between true and relative trails.

**5.7.30** Targets shall be presented in accordance with relevant symbols according to the requirements of 5.7.58.

The target information may be provided by the radar tracking function and by the reported target information from the AIS.

The number of targets present shall be as defined in Table 5.7.2.

A warning alarm shall be automatically actuated when the target number (radar tracked or AIS reported targets) is about to be maximum.

As far as practical, the data formats for operating and displaying the radar and AIS targets shall be consistent.

**5.7.31** Radar targets shall be provided by the radar transceiver. The signals shall be filtered with the aid of the associated clutter controls. Radar targets may be automatically or manually acquired and tracked using an automatic target tracking facility.

The automatic target tracking calculations shall be based on the measurement of radar target relative position and own ship motion.

Any other sources of information, when available, may be used to support the optimum tracking performance.

Target tracking facilities shall be available on at least the 3, 6 and 12 miles range scales. Tracking range shall extend to a minimum 12 miles.

The radar system shall be capable of tracking targets having the relative speed equivalent to those at which sea-going ships including high-speed craft can operate.

**5.7.32** In addition to the requirements for processing of targets reported by AIS, it shall be possible to provide presentation for a number of radar targets according to Table 5.7.2. When the established target tracking capacity is about to be exceeded, target overflow shall not degrade the radar system performance.

**5.7.33** Manual and automatic acquisition of radar targets shall be provided with provision for acquiring the number of targets specified in Table 5.7.2. There shall be means for the user to define the boundaries of the auto-acquisition area.

**5.7.34** When a target is acquired, the system shall present the trend of the target's motion within one minute and the prediction of the target's motion within 3 min.

The target tracking system shall be capable of updating the information of all acquired targets automatically and shall continue to track radar targets that are clearly distinguishable on the display for 5 out of 10 consecutive scans.

The target tracking system design shall be such that smoothed target vector is calculated, while target manoeuvres shall be detected as early as possible.

The possibility of tracking errors, including target swap, shall be minimized.

Separate facilities for cancelling the tracking of any one and of all targets shall be provided.

The greatest possible automatic tracking accuracy shall be achieved when the tracked target has achieved a steady state and with the required accuracy performance of the information sensor.

For ships capable of up to and including 30 kn true speed, the tracking facility shall present, within 1 min steady state tracking, the relative motion trend and after 3 min, the predicted motion of a target, within the accuracy values specified in Table 5.7.34.

Accuracy may be significantly reduced under the following conditions:

- shortly after acquisition;
- own ship manoeuvre;
- a manoeuvre of the target;
- any tracking disturbance;

sensor accuracy.

Measured target range and bearing shall be within:

50 m (by range) (or 1 % of target range);

2° (by bearing).

For ships capable of speeds in excess of 30 kn and with speeds of up to 70 kn, the motion accuracy values specified in Table 5.7.34 shall be maintained with target relative speeds of up to and including 140 kn.

Table 5.7.34

Tracked Target Accuracy (95 % probability figures)

Time of steady state (min)	Relative course (deg)	Relative speed (kn)	$D_{ap}$ (NM)	Tap (min)	True course (deg)	True speed (kn)
1min: Trend	11	1,5 or 10 % (whichever is greater)	1	—	—	—
3 min: Motion	3	0,8 or 1 % (whichever is greater)	0,3	0,5	5	0,5 or 1 % (whichever is greater)

A ground referencing function, based of a stationary tracked target, shall be provided . Targets used for this function shall be marked with the relevant symbol.

**5.7.35** Reported targets provided by the AIS shall be displayed according to pre-defined parameters. Targets may be sleeping, or may be activated.

Activated targets shall be treated in a similar way to radar tracked targets.

There shall be an automatic indication when the capacity of display of AIS targets (sleeping and/or activated) is about to be exceeded.

**5.7.36** To reduce display clutter, a means to filter the presentation of sleeping AIS targets shall be provided, together with an indication of the filter status (e. g. by target range, distance and time to the closest point of approach —  $D_{ap}$ ,  $T_{ap}$ , AIS target class: A, B, etc.). It shall not be possible to remove individual AIS targets from the display.

**5.7.37** A means shall be provided to activate a sleeping AIS target and to deactivate the activated AIS targets.

If zones for the automatic activation of AIS targets are provided, they shall be the same as for automatic radar target acquisition.

In addition to the beginning of activation the AIS targets when entered in the established zone, sleeping AIS targets may be automatically activated when meeting user defined parameters: target range, distance and time to the closest point of approach ( $D_{ap}$ ,  $T_{ap}$ ), AIS target class (A, B).

**5.7.38** The AIS target presentation status shall be in accordance with Table 5.7.38.

Table 5.7.38

The AIS presentation status

Function	Cases to be presented		Presentation
AIS On/Off	AIS processing switched on/graphical presentation switched off	AIS presentation switched on/graphical presentation switched on	Alphanumeric or graphical
Filtering of sleeping AIS targets	Filter status	Filter status	Alphanumeric or graphical
Activation of targets		Activation criteria	Graphical
$D_{ap}/T_{ap}$ alarm	Function On/Off Sleeping targets included	Function On/Off Sleeping targets included	Alphanumeric and graphical
Lost target alarm	Function On/Off Lost target filter criteria	Function On/Off Lost target filter criteria	Alphanumeric and graphical
Target association	Function On/Off Association criteria Default target priority	Function On/Off Association criteria Default target priority	Alphanumeric

**5.7.39** Symbols for presentation of AIS target on the radar display shall be in accordance with the requirements of 5.7.58.

AIS targets that are displayed shall be presented as sleeping targets by default.

The course and speed of a tracked radar target or reported AIS target shall be indicated by a predicted vector of adjustable length.

Permanent and clear indication of vector time and stabilization shall be provided.

The consistent common reference point of own ship shall be used for presentation of radar targets and AIS targets on the radar display.

To present activated targets on close range from the own ship, a means to present the true scale outline of an activated AIS target shall be provided.

It shall be possible to display the past track of activated AIS targets.

**5.7.40** It shall be possible to select any tracked radar or AIS target for alphanumeric display of its data. A target selected for display shall be identified by the relevant symbol. If more than one target is selected for data display, the relevant symbols and the corresponding data shall be clearly indicated. There shall be a clear indication to show that the target data is derived from radar or from AIS.

For each selected target, the following data shall be presented in alphanumeric form:

source of data (radar or AIS);

range of target;

bearing of target;

COG (course over ground);

speed over ground;

$D_{ap}$  and  $T_{ap}$ .

Additionally, for each selected tracked AIS target the following data shall be presented:

ship's identification;

navigational status (underway, at anchor, etc.);

position.

Target heading and reported rate of turn of the AIS target may be also made available.

Additional target information may be provided on request.

If the received AIS information is incomplete, the absent information shall be clearly indicated as "MISSING" within the target data field.

The data on selected target shall be displayed and continually updated, until another target is selected for data display or until the window is closed.

Means shall be provided to present own ship AIS data on request.

**5.7.41** A clear indication of the cause for all alarm criteria shall be given.

If the calculated  $D_{ap}$  and  $T_{ap}$  values of a tracked target or activated AIS target are less than the set limits; a  $D_{ap}/T_{ap}$  alarm shall be given;

the alarmed target shall be clearly indicated.

The preset  $D_{ap}/T_{ap}$  limits applied to targets from radar and AIS shall be identical. The  $D_{ap}/T_{ap}$  alarm functionality shall be applied for all activated AIS targets.

On request the  $D_{ap}/T_{ap}$  alarm functionality may also be applied to sleeping AIS targets.

When new targets are detected within the defined acquisition zone for automatic tracking and when new AIS targets are activated, these targets shall be clearly identified and an alarm shall be given.

The system shall alert the user if a tracked radar target is lost, rather than excluded by a pre-determined range or pre-set parameter. The last position of the target removed from tracking shall be clearly indicated on the display.

It shall be possible to enable or disable the lost target alarm function for AIS targets. A clear indication shall be given if the target is lost and if the lost target alarm is disabled.

The last position of the lost AIS target shall be clearly indicated on the display.

**5.7.42** The indication of the lost target shall disappear if the AIS signal is received again, or after the lost target alarm has been acknowledged. A means of recovering limited historical data from previous AIS reports on lost targets shall be provided.

It shall not be possible to display one physical target as two independent targets (radar and AIS targets).

If the association criteria are fulfilled such that the radar and AIS reported information are considered as one physical target, than as a default condition, such target shall be displayed by the activated AIS target symbol and alphanumeric AIS target data.

The user shall have the option to change the default condition to display data and shall be permitted to select target data source ( radar or AIS).

If the AIS and radar information become sufficiently different, the AIS and radar information shall be considered as two distinct physical targets and one activated AIS target and one tracked radar target shall be displayed. No alarm shall be raised.

**5.7.43** On ships of 10000 gross tonnage and upwards the radar system shall be capable of simulating the manoeuvre, namely, shall provide a possibility of simulating the approach situations during the manoeuvre with due regard for own ship's dynamic characteristics.

A trial manoeuvre simulation shall be clearly identified.

The requirements are:

the simulation of own ship course and speed shall be variable;

a simulated time to manoeuvre with a countdown shall be provided;

during simulation, target tracking shall continue and the actual target data shall be indicated;

trial manoeuvre shall be applied to all tracked radar target and all activated AIS targets.

**5.7.44** It shall be possible for the user to manually display sketch maps of the navigation area, various navigation lines, routes referenced to own ship and its geographical position. It shall be possible to remove the display of this data by a simple operator action.

The sketch maps may consist of lines, symbols and reference points, which shall comply with the requirements of 5.7.58.

The displayed additional marks and symbols shall not degrade the radar information. The displayed information shall be retained when the equipment is switched off and restored when a relevant equipment module is replaced.

**5.7.45** The radar system may provide the means to display electronic navigation charts (ENC) to provide real-time sailing conditions monitoring.

The displayed ENC shall comply with International Hydrographic Organization (IHO)'s relevant standards.

It shall be possible to display information derived from ENC updates.

It shall be possible to display ENC by levels or categories of information, but not by individual objects or chart symbols.

The display of ENC shall use the same reference criteria as the AIS, including consistent common reference point of own ship and datum. Scale and orientation of ENC and radar indication shall be identical.

It shall be possible to remove the display of chart data by a single operator action.

The display of radar information shall have priority over all other data which may be displayed. Chart information shall be displayed such that radar information is not obscured or degraded. Chart information shall be clearly perceptible as such.

A malfunction of the source of chart data shall not affect the operation of the radar/AIS system.

**5.7.46** Alarm shall be provided to alert the user of "picture freeze". Failure of any sensor interfaced to the radar, including: gyro, log, aerial position sensor shall be alarmed.

In case of the radar failure, provision shall be made for transfer to the use of accessible standby means or arrangements shall be made to continue the radar operation with some system functionalities being limited in use.

**5.7.47** When multiple radars operate jointly, the system shall safeguard against single point system failure.

When an integrated multiple radar system includes components of the same purpose, provision shall be made for interswitching thereof.

The mode used to receive and process the radar information as well as the operational data on system status shall be indicated at each display position.

**5.7.48** The radar operational controls shall ensure that radar system is simple and convenient to operate. The radar system shall be capable of being switched "on" or "off" at the main system radar display or at an additional control position.

The radar control functions may be realized as an individual control panel or with the use of a programmed access to control (e. g. on-screen menu) or a combination of these.

The primary control functions shall be dedicated hardware controls or control keyboard, with an associated status indication. The following are defined as primary radar control functions:

- radar standby/run;
- range scale selection;
- gain;
- manual tuning function (if applicable);
- anti-clutter rain;
- anti-clutter sea;
- AIS function on/off;
- alarm acknowledge;
- cursor;
- a means to set EBL;
- a means to set VRM;
- display brightness;
- acquisition of radar targets.

The primary functions shall be operated directly at the main system radar display in addition to the remote control positions.

**5.7.49** The radar system shall include a means to record the total operating hours for any components with a limited life.

Provision shall be made to identify the radar failures.

**5.7.50** Provision shall be made to switch off automatically high-frequency radiation within the preset sectors. Indication of these sectors shall be provided.

**5.7.51** The radar aerial shall be designed to operate reliably in wind speeds likely to be encountered on the class of ship on which it is installed.

The rotation rate shall be such as to provide an appropriate information update rate.

There shall be a means to prevent aerial rotation and electromagnetic radiation during servicing, or while personnel are in the vicinity of the aerial or up-mast units.

**5.7.52** The radar design shall ensure that the radar system can be operated by trained users.

A target simulation facility shall be provided for training purposes and for acquiring skills in operation.

**5.7.53** The radar system shall be capable of receiving the required input information (in standard format) from:

- a gyrocompass or transmitting heading device;
- a log;
- radionavigation system receiver;
- AIS equipment;
- other sources of equivalent information.

**5.7.54** Means shall be provided in the radar system to preclude the use of invalid data. If quality and validity of input data are identified as inconsistent with the requirements this shall be clearly indicated.

As far as is practical, the integrity of data coming from external sensors shall be checked. Such check shall be carried out by comparison with other connected sensors or by other accessible checks such as testing to ascertain that the current data do not exceed the allowable data limits.

The latency of processing input data shall be minimized.

**5.7.55** It shall be possible to provide information (in standard format) by any radar output interface to other ship's systems.

The radar system shall provide an output of the display data for the voyage data recorder.

At least one normally closed contact (isolated) shall be provided for indicating failure of the radar.



The radar shall have a bi-directional interface to other systems to facilitate communication so that alarms indicating failure of the radar can be transferred to external systems and so that audible alarms from the radar can be remotely muted from external systems.

**5.7.56** In the event of failure in receiving input data from external information sources maintaining operation of the radar there shall be an appropriate permanent indication. Depending on the nature of failure, the following basic functions shall be performed:

**.1** in the event of failure of information from gyrocompass (transmitting heading device) the radar equipment shall operate satisfactorily in an "unstabilized head-up" mode. The stabilization mode shall be changed automatically within 1 min after a failure in receiving appropriate information from external source.

If automatic anticlutter sea processing could prevent the detection of targets in the absence of azimuth stabilization, the processing shall switch off automatically within 1 min.

An indication shall be given that only relative bearing measurements can be used;

**.2** in the event of failure of speed through water information a means of manual speed input shall be provided;

**.3** in the event of failure of speed or course and speed over ground information the equipment shall be operated with speed through water information;

**.4** in the event of failure of position input information the electronic navigation chart shall be displayed if only at least a single reference point with known position is used or the position is manually entered;

**.5** in the event of failure of radar video input information from the radar components ensuring radiation and reception of radar signals, the equipment shall continue to display target information based on AIS data. The last radar picture shall not be displayed;

**.6** in the event of failure of AIS input information, the equipment shall display the radar video and target database;

**.7** in the event of failure of information from other ship's systems interfaced to the radar, the equipment shall be capable of operating equivalent to stand alone system.

**5.7.57** The radar operating instructions shall contain a detailed information on all possible functions, including: recommended settings of controls for different weather conditions of radar operation;

performance of the radar system;

operator's actions in case of failures;

limitations of the display and tracking process and accuracy, including any delays in processing and presentation of information;

using own ship heading and speed over ground/course over ground information for collision avoidance;

limitations and conditions of target association, separate target presentation;

criteria of selection for automatic acquisition of AIS targets and cancellation of activation;

methods applied to display AIS targets and any limitations;

principles underlying the trial manoeuvre technology, including simulation of own ship's manoeuvring characteristics, if provided;

alarms and indications;

equipment installation and arrangement requirements;

radar range and bearing accuracies;

additional functional capabilities and operator's actions (e. g. for detection of SARTs);

the value of the consistent common reference point of own ship in the information processing and presentation process;

factors affecting the change of radar performance.

The manufacturer's instructions for the radar system installation shall be an integral part of the technical documentation.

**5.7.58** Abbreviations of terms used in displaying the operation modes and other information shall be in accordance with those given in Table 5.7.58-1.

Abbreviations of displayed units shall be in accordance with those given in Table 5.7.58-2.

Symbols used to indicate the radar targets, AIS targets and other marks on the radar display of own ship shall be in accordance with those given in Table 5.7.58-3.

Terms and their abbreviations

Abbreviation	Term used	
	English	Russian
ACK	Acknowledge	Подтверждение
ACQ	Acquire, Acquisition	Захват
AZ	Acquisition zone	Зона захвата
AFT	Aft	Корма
ALARM	Alarm	Тревога
ALT	Altitude	Высота
AM	Amplitude modulation	Амплитудная модуляция
ANCH	Anchor watch	Якорная вахта
ANT	Antenna	Антенна
RAIN	Anti clutter rain	Подавление помех от дождя
SEA	Anti clutter sea	Подавление помех от волнения моря
AUD	Audible	Звуковой
AUTO	Automatic	Автоматическое
AFC	Automatic frequency control	Автоматическое управление частотой
AGC	Automatic gain control	Автоматическое усиление
AIS	Automatic Identification System	Автоматическая идентификационная система
AUX	Auxiliary system/function	Дополнительная система / функция
AVAIL	Available	Доступность
BKGND	Background	Обзор
BRG	Bearing	Пеленг
BWW	Bearing waypoint to waypoint	Пеленг с путевой точки на другую путевую точку
BRILL	Brilliance	Яркость
CAL	Calibrate	Калибровка
CNCL	Cancel	Отмена
CENT	Centre	Центр
CHG	Change	Изменение
CP	Circular polarized	Круговая поляризация
CLR	Clear	Очистка
CPA	Closest point of approach	Точка кратчайшего сближения
CCRS	Consistent common reference point	Общая опорная точка
CONT	Contrast	Контраст
CORR	Correction	Корректурa
CRS	Course	Путевой угол (курс)
COG	Course over the ground	Путевой угол (курс) относительно грунта
CTW	Course through the water	Путевой угол относительно воды (с учетом дрейфа)
CTS	Course to steer	Заданный путевой угол
CUP	Course up	Ориентация по путевому углу
XTD	Cross track distance	Траверзное расстояние
CURS	Cursor	Курсор
DG	Dangerous goods	Опасные грузы
DATE	Date	Дата
DR	Dead reckoning	Счисление пути
DECR	Decrease	Уменьшение
DEL	Delete	Удалить
DEP	Departure	Отшествоие
DPTH	Depth	Глубина
DEST	Destination	Пункт назначения
DEV	Deviation	Девиация
DGNSS	Differential GNSS	Дифференциальный режим ГНСС
DSC	Digital selective calling	Цифровой избирательный вызов (ЦИВ)
DISP	Display	Дисплей
DIST	Distance	Расстояние
DRMS	Distance root mean square	Среднее квадратическое отклонение по расстоянию
DTG	Distance to go	Заданное расстояние
DRIFT	Drift	Дрейф
E	East	Восток
EBL	Electronic bearing lane	Электронная линия пеленга
EPFS	Electronic position fixing system	Электронная система определения местоложения
ENH	Enhance	Увеличение заметности
ERR	Error	Погрешность (ошибка)
EP	Estimated position	Счислимое место с учетом дрейфа
ETA	Estimated time of arrival	Расчетное время прихода
EVENT	Event	Событие

Abbreviation	Term used	
	English	Russian
EXT	External	Внешний
FIX	Fix	Определение места
FM	Frequency modulation	Частотная модуляция
FULL	Full	Полный
GAIN	Gain	Усиление
GDOP	Geometric dilution of precision	Геометрический фактор ухудшения точности
GNSS	Global navigation satellite system	Глобальная спутниковая навигационная система
GC	Great circle	Большой круг
GND	Ground	Поверхность Земли
GRI	Group repetition interval	Групповой интервал повторения
GZ	Guard zone	Охранная зона
GYRO	Gyro	Гирокомпас
HS	Harmful substances	Сообщение об опасных грузах
HUP	Head up	Ориентация по курсу
HDG	Heading	Курс
HCS	Heading control system	Система управления курсом судна
HL	Heading line	Линия курса
HF	High frequency	Высокая частота
HSC	High speed craft (HSC)	Высокоскоростное судно (ВСС)
HDOP	Horizontal dilution of precision	Горизонтальный геометрический фактор ухудшения точности
ID	Identification	Идентификация
INCR	Increase	Увеличение
IND	Indication	Индикация
INFO	Information	Информация
INF RED	Infrared	Инфракрасный
INIT	Initialization	Начало
INP	Input	Ввод
I/O	Input/Output	Ввод/Вывод
IRCS	Integrated Radio Communication System	Интегрированная система радиосвязи
IR	Interference rejection	Подавление помех
ISW	Interswitch	Переключение
INT	Interval	Интервал
LAT	Latitude	Широта
LIM	Limit	Предел (предельное значение)
LOP	Line of position	Линия положения
LOG	Log	Лаг
LR	Long range	Большая дальность
LON	Longitude	Долгота
LOST TGT	Lost target	Потерянная цель
LF	Low frequency	Низкая частота
MAG	Magnetic	Магнитный
MVR	Maneuver	Маневр
MAN	Manual	Ручное
MAP	Map	Карта
MAX	Maximum	Максимум
MMSI	Maritime mobile services identity number	Идентификационный номер морской подвижной службы
MENU	Menu	Меню
MP	Maritime pollutant	Загрязнитель морской среды
MIN	Minimum	Минимум
MSI	Maritime safety information	Информация по безопасности мореплавания
MKR	Marker	Маркер
MSTR	Master	Капитан
MF	Medium frequency	Средние частоты
MISSING	Missing	Ошибки
MUTE	Mute	Тишина (без звука)
NAV	Navigation	Навигация
N	North	Север
NORM	Normal	Нормальный (ое)
N UP	North up	Ориентация по меридиану
OFF	Off	Выключить (ено)
OOW	Officer on watch	Вахтенный офицер
OFFSET	Offset	Сдвиг
ON	On	Включить (ено)
OUT	Out/Output	Ввод/Вывод
OS	Own ship	Ввод/Вывод

Abbreviation	Term used	
	English	Russian
PANEL	Panel illumination	Собственное судно
PI	Parallel index line	Освещение панели
PASSV	Passenger vessel	Линия параллельного индекса
PERM	Permanent	Пассажирское судно
POB	Person overboard	Постоянно
PIN	Personal identification number	Человек за бортом
PILOT	Pilot vessel	Личный номер члена экипажа
PORT	Port/Portside	Лоцманское судно
POSN	Position	Левый борт
PDOP	Positional dilution of precision	Координаты
PWR	Power	Фактор ухудшения точности места
PRED	Predicted	Питание
PPC	Predicted point of collision	Прогнозируемое
PRF	Pulse repetition frequency	Расчетная точка столкновения
PPR	Pulse per revolution	Частота повторения импульсов
RACON	Racon	Число импульсов на оборот
RADAR	Radar	Радиолокационный маяк-ответчик
RAIN	Rain	Радиолокационная станция
RGN	Range	Дождь
RR	Rang rings	Расстояние (дальность)
RCDS	Raster chart display system	Кольца дальности
RNC	Raster navigational chart	Система отображения растровых карт
ROT	Rate of turn	Растровая навигационная карта
RX	Receiver	Угловая скорость поворота
RM	Relative motion	Приемник (приемное устройство)
RPM	Revolution per minute	Относительное движение
RMS	Root mean square	Число оборотов в минуту
ROUTE	Route	Среднее квадратическое отклонение
S	South	Путь
SF CNT	Safety contour	Юг
SAIL	Sailing vessel	Контур безопасности
SAT	Satellite	Парусное судно
S – BAND	S - band	Спутник
SARV	Search and rescue vessel	Полоса частот – S диапазона
SEL	Select	Спасательное судно
SEQ	Sequence	Выбор
SET	Set	Последовательность
TIME	Ship's time	Снос
SP	Short pulse	Судовое время
SNR	Signal to noise ratio	Короткий импульс
SIM	Simulation	Отношение сигнал / помеха
SPD	Speed	Проигрывание
SDME	Speed and distance measuring equipment	Скорость
SOG	Speed over the ground	Устройство измерения скорости и пройденного расстояния
STW	Speed through the water	Скорость относительно грунта
STBY	Stand-by	Скорость относительно воды
STBD	Starboard side	Готовность
STN	Station	Правый борт
SYNC	Synchronization	Станция
TGT	Target	Синхронизация
TT	Target tracking	Цель
TEST	Test	Сопровождение цели
TIME	Time	Проверка (испытание)
TD	Time difference	Время
TOA	Time of arrival	Разница во времени
TOD	Time of departure	Время прибытия
TCPA	Time to CPA	Время отбытия
TTG	Time to go	Время сближения на кратчайшее расстояние
TWOL	Time to wheel over line	Время перехода
TRK	Track	Время подхода к линии поворота
TCS	Track control system	Путь судна
TMG	Track made good	Система управления траекторией судна
TRAIL	Trail	Заданный путь
TPL	Transferred line of position	След
THD	Transmitting heading device	Смещенная линия положения

Table 5.7.58-1 — continued

Abbreviation	Term used	
	English	Russian
TRIAL	Trial	Устройство для передачи курса
TRIG	Trigger pulse	Проигрывание
TM	True motion	Триггерный импульс
TUNE	Tune	Истинное движение
UHF	Ultrahigh frequency	Настройка
UTC	Universal time coordinated	Сверхвысокая частота
VRM	Variable range marker	Универсальное координированное время
VAR	Variation	Подвижный индекс
VECT	Vector	Склонение
VHF	Very high frequency	Вектор
VLF	Very low frequency	Высокая частота
GRND	Vessel aground	Сверхнизкая частота
ANCH	Vessel at anchor	Судно, сидящее на грунте
VCD	Vessel constrained by draught	Судно на якоре
DIVE	Vessel engaged in diving operation	Судно, стесненное своей осадкой
DRG	Vessel engaged in dredging or underwater operation	Судно, занятое водолазными работами
TOW	Vessel engaged in towing operation	Судно, занятое дноуглубительными работами
NUC	Vessel not under command	Судно, занятое буксировкой
RIM	Vessel restricted in maneuverability	Неуправляемое судно
VTS	Vessel traffic service	Судно, ограниченное в возможности маневрирования
VID	Video	Система управления движением судов
VDR	Voyage data recorder	Видео
WARNING	Warning	Регистратор данных рейса
WAT	Water	Предупреждение
WPT	Waypoint	Вода
W	West	Путевая точка
WOL	Wheel over line	Запад
WOT	Wheel over time	Линия подачи команды на перекладку руля
X - BAND	X – band	Время подачи команды на перекладку руля

Table 5.7.58-2

Abbreviation	Term used	
	English	Russian
bl	cable length	кабельтов (расстояние)
ps	cycles per second	частота (число периодов в секунду)
deg	degree (s)	градус (ы)
fm	fathom (s)	сажени
ft	feet / foot	футы
GHz	Gigahertz	гигагерцы (ГГц)
hPa	HectoPascal	гектопаскали (гПа)
Hz	Hertz	герцы (Гц)
hr	hour (s)	час (ы)
kHz	Kilohertz	килогерцы (кГц)
km	Kilometer	километры (км)
kPa	Kilopascal	килопаскали (кПа)
kn	knot (s)	узлы
MHz	Megahertz	мегагерцы (МГц)
min	minute (s)	минуты
NM	nautical mile (s)	морские мили

Symbols







Topic	Symbol	Description
<b>Own Ship Symbols</b>		
Own ship		Double circle, located at common reference position. Use of the symbol is optional, if own ship position is shown by the combination of heading line and beam line.
Own ship true scale outline		The symbol size corresponds to the image scale. The true scale outline is oriented along own ship's heading. The position of the symbol is the common reference point.
Own ship radar aerial position		Cross located at the physical location of the radar aerial that is the current source of displayed radar video.
Own ship heading line		Solid line whose length is limited by bearing scale. If the bearing scale is not displayed the heading line shall have a limited length. Origin is at the common reference point.
Own ship beam line		Solid line of fixed or variable length. Midpoint is at common reference point.
Own ship speed vector		Dashed line — short dashes with spaces approximately twice the line width of heading line. Time increments may optionally be marked along the dashed line using short intersecting lines. To indicate water/ ground stabilization one or two arrowheads, respectively, may be added at the speed vector endpoint.
Own ship path prediction		A curved vector may be provided as a path predictor.
Own ship past track		Thick line for primary source of navigational information. Thin line for secondary source. Optional time marks are allowed.
<b>Tracked Radar Target Symbols</b>		
Tracked target including dangerous target		Solid filled or unfilled circle . The speed vector shall be displayed as dashed line with short dashes with spaces approximately twice the line width. Optionally, time increments may be marked along the vector. For a dangerous target bold red (on colour display) solid circle with speed vector flashing until acknowledged.
Target in acquisition state		Circle segments. For automatic acquisition, bold circle segments, flashing and red (on colour display) until acknowledged.
Lost target		Bold lines across the circle, flashing until acknowledge
Selected target		A square indicated by its corners centred around the target symbol. Dots, equally spaced by time

Table 5.7.58-3 — continued



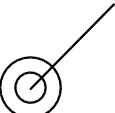
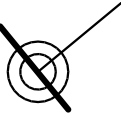
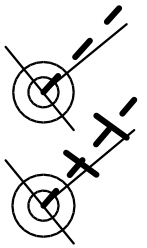

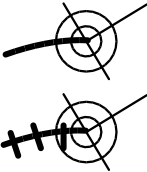
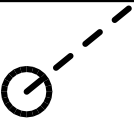

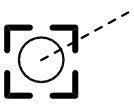



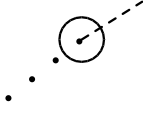



Topic	Symbol	Description
Target past positions		Large R adjacent to designated tracked target.
Tracked reference target	<b>R</b>	Multiple reference targets shall be marked as R1, R2, R3, etc.
<b>AIS Target Symbols</b>		
AIS target (sleeping)		An isosceles, acute-angled triangle shall be used. The triangle shall be oriented by heading or course over ground. The reported position shall be located at half the height of the triangle. The symbol of the sleeping target shall be smaller than that of the activated target.
Activated AIS target including dangerous target		An isosceles, acute-angled triangle shall be used. The triangle shall be oriented by heading or course over ground. The speed over ground vector shall be displayed as a dashed line with short dashes with spaces approximately twice the line width. The heading shall be displayed as a solid line with length twice of the length of the triangle symbol. Origin of the heading line is the apex of the triangle. The turn shall be indicated by a short intersecting line. A path predictor may be provided as curved vector. For a Dangerous AIS Target bold, red (on colour display) solid triangle with speed vector flashing until acknowledged.
AIS target — true scale outline		A true scale outline may be added to the target symbol if the selected range scale makes this action possible.
Selected target		A square indicated by its corners.
Lost target		Triangle with bold solid cross. The cross shall have a fixed orientation. The triangle shall be oriented per last heading value. The symbol shall flash until acknowledged.
Target past positions		Dots, equally spaced by time.
<b>Other Symbols</b>		
Real position of charted object		Diamond with crosshair centred at reported position.
Virtual position		Diamond with crosshair centred at reported position.

Table 5.7.58-3 — continued

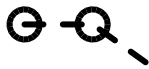
Topic	Symbol	Description
Monitored route		Dashed bold line, waypoints as circles.
Planned or alternate route		Dotted lines, waypoints as circles.
Trial manoeuvre		Large T on screen.
Simulation mode		Large S on screen.
Cursor		Crosshair (two alternatives).
Range rings		Solid circles.
Variable range markers		Circle.
Electronic bearing lines		Dashed line.
Acquisition /Activation area		Solid line boundary for an area.
Event mark		Rectangle with diagonal line, clarified by added text (e.g. "MOB" for man overboard case).

**5.7.59** The radars for ships of river-sea navigation (marks for restricted areas of navigation in the character of classification of a ship are **R2-RSN**, **R2-RSN(4,5)** and **R3-RSN**) engaged on inland waterways voyages shall, in addition to requirements in 5.1, 5.7.1, 5.7.7 to 5.7.9, 5.7.14 comply with the following requirements.

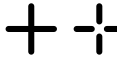
**5.7.59.1** The display unit of the radar installed on board ship with the aerial height above sea level being equal to 10 m shall be capable of giving clear presentation of various objects within the ranges (in kilometers) given below:

Shore of height, m:		
60	.....	37
6	.....	13
Ship of gross tonnage:		
5000	.....	13
20	.....	4
Buoy with reflecting surface of 10 m <sup>2</sup> .	.....	4

The display of all objects shall remain visible when the ship is rolling or pitching up to  $\pm 10^\circ$ .

**5.7.59.2** Basic performance parameters of the shipboard radar with the aerial height of 7 m above sea level shall not be worse than those specified in Table 5.7.59.2.

The equipment performance shall not deteriorate when the ship is rolling and pitching up to  $\pm 10^\circ$ .

Table 5.7.59.2

Basic performance parameters	Value
Minimum radar detection range, m	15
Range resolution on dials 0,4 to 1,2 km, m	15
Range resolution on the rest dials in relation to the maximum value of the range dial established, %	1
Accuracy in range measuring, m	10
Bearing resolution, deg	1,0
Accuracy in measuring bearings, deg	1,0
Accuracy in course indication, deg	0,5



**5.7.59.3** The display shall have an effective diameter of at least:

180 mm for ships from 300 to 1600 gross tonnage;

250 mm for ships from 1600 gross tonnage and over.

The display unit of the radar shall be provided with six range scales from 400 m to 5000 m. In this regard there shall be indicated not less than four fixed electronic range rings and a variable electronic marker range with a numeric read-out of range in meters (kilometers) on each range scale.

The variable electronic marker range shall enable the range of an object to be measured with an error not more than 10 m on range scales of 0,4 to 2,0 km and 0,8 % of the range of the following scale established.

**5.7.59.4** It shall be possible that brightness of the fixed electronic range rings and a variable electronic marker be varied until they are fully removed from the display.

**5.7.59.5** The display unit of the radar shall be fitted with the electronic or mechanical device for taking bearings of the detected objects.

**5.7.59.6** In radar provision be made for clockwise, continuous and automatic scan through 360° of azimuth. The scan rate shall be not less than 18 r.p.m. The aerial shall operate satisfactorily in relative wind speeds up to 50 m/s.

**5.7.59.7** It shall be possible to off-set the radar origin to any display point for a distance of at least 0,5 of the display radius.

**5.7.59.8** The radar display provided with two sets of range scales, in meters (kilometers) and miles, shall have the means of switching-over and the relevant indication of a measurement unit chosen for range measuring.

## **5.8 RADAR REFLECTOR**

**5.8.1** The radar reflector (either active or passive) shall have effective echoing area to enable detection by ships navigating by radar at both 9 GHz and 3 GHz bands whose wavelengths are 3 cm and 10 cm respectively.

**5.8.2** The radar reflector shall have the following nominal level of the effective echoing area when mounted at a minimum height of 4 m above water level:

at least 7,5 m<sup>2</sup> in 9 GHz band;

0,5 m<sup>2</sup> in 3 GHz band.

**5.8.3** The nominal minimum level for reflector effective echoing area, as per 5.8.2, shall be maintained over a total of at least 280° azimuth.

**5.8.4** The radar reflector polar diagram shall be such that any single angle with a response below nominal minimum level would not be greater than 10° (zero range), and the distances between the neighboring zero ranges shall be less than 20°.

**5.8.5** For self-propelled ships and sailing vessels designed to operate with little heel and/or trim (catamaran/trimaran), the requirements of 5.8.2 shall be met through angles of heel 10° either side of vertical. For other sailing vessels, these requirements shall be met through angles of heel 20° or more either side of vertical.

**5.8.6** The radar reflector shall be clearly and respectively marked where it meets the requirements specified in 5.8.2 at ±20° inclination (heel).

**5.8.7** The manufacturer recommended mounting height (not less than 4 m) and any preferred orientation shall be clearly marked directly on the radar reflector.

**5.8.8** Active radar reflectors shall conform to relevant requirements of International Telecommunication Union (ITU).

**5.8.9** The radar reflector shall be capable of maintaining its reflection performance under the conditions of sea states and action of any climatic and mechanical factors specified in 5.1.

**5.9 RADIOBEACON STATION**

**5.9.1** The basic performance parameters of the radiobeacon station are specified in Table 5.9.1.

Table 5.9.1

Nos.	Parameter	Value
1	Frequency range, kHz (four frequencies tuning by clamping method)	315 to 526,5
2	Class of emissions	A2A
3	Modulating frequency under all destabilizing factors, Hz	400 ± 25

The tolerance of frequency of radiobeacon station shall not exceed 100 Hz.

**5.9.2** The transmitter shall be capable of transmitting audio modulated fluctuations of frequencies 400 Hz with continuity of carrier frequency and automatically producing two-letter signal of Morse signals with interval of half a minute and speed of 5 bauds.

Duration of signals:

"dot", ms —  $240 \pm 10$  %;

"dash", ms —  $720 \pm 10$  %.

## **5.10 REMOTE TRANSMITTING HEADING DEVICE**

**5.10.1** The remote transmitting heading device operating together with the sensing part (heading sensor) in latitudes of up to 70° shall ensure an output signal meeting at least the following accuracy (subject to the sensing part remaining operative under the conditions likely to be encountered during the ship's service (including high-speed):

- .1** the transmission and resolution error shall be less than  $\pm 0,2^\circ$ ;
- .2** the static error measured at permanent speed and direction of the ship shall be less than  $\pm 1,0^\circ$ ;
- .3** the dynamic error measured under the conditions of roll, pitch, vibrations or change of speed shall be less than  $\pm 1,5^\circ$ . If the amplitude of the dynamic error exceeds  $\pm 0,5^\circ$ , the dynamic error frequency shall be less than 0,033 Hz equivalent to a period not shorter than 30s;
- .4** the follow-up error for different rates of turn shall be less than:  
 $\pm 0,5^\circ$  at rates up to 10°/s;  
 $\pm 1,5^\circ$  between a rate of 10°/s to 20°/s.

**5.10.2** Any corrective devices to introduce modifications in the true heading information transmitted by the device shall be protected against inadvertent operation.

**5.10.3** Manually settable values used for electronic correction shall be indicated by adequate means.

**5.10.4** An alarm shall be provided to indicate malfunctions of the device or a failure of the power supply.

**5.10.5** At least one output channel shall be provided to transmit the true course information to other navigational equipment in compliance with IEC 61162.

**5.10.6** If a device for remote transmission of the magnetic compass course is provided on board, it shall meet the above requirements of the present Chapter, applicable requirements of 5.2 under the prevailing environmental conditions and ensure the following:

**.1** be capable of indication of deviation and variation values indispensable for calculation of the total compass correction. The said values shall be displayed directly or accounted for in the output.

All the heading data displayed and output, which is generated by the device for remote transmission of magnetic compass course shall be automatically converted into the true ship's heading.

The magnetic system of the standard magnetic compass or special magnetic sensing parts may be used as a sensing part of the compass with remote electrical transmission of card readings.

Where the magnetic system of the standard magnetic compass is used as a sensing part for remote transmission of card readings, the device for electrical transmission of readings to repeaters and remote transmitting heading device shall be so designed that their arrangement and operation will in no way affect taking bearings, indication of course and bearing of the compass card, as well as the work for compensation of deviation;

**.2** divergence between the readings of repeaters of repeaters and those of the sensitive element of the magnetic compass fitted with remote transmission of dial readings shall not exceed 1°;

**.3** the accuracy of readings of the standard compass and the operating repeaters shall not be affected by failure or switching-off of separate repeaters;

**.4** audible alarm indicating failure in the follow-up system of the magnetic compass with remote electric transmission of card readings. The audible alarm shall be supplied from independent source of electrical power;

**.5** the set of magnetic compass with remote electric transmission of card readings shall be provided with a special lighted panel "Repeaters are switched to magnetic compass" shall be included into a complete set of the magnetic compass fitted with remote electric transmission of readings (refer to 3.7.2.8).

## **5.11 RADIONAVIGATION SYSTEM RECEIVERS**

**5.11.1** Radionavigational system receivers shall comply with general requirements of 5.1, as well as provide for the following:

**.1** required accuracy of the ship's positioning in accordance with the type of the employed radionavigational system or systems;

**.2** possibility of its interfacing with navigational equipment and integrated navigation system. The data output shall be in compliance with the International Standard on Digital interfaces for Maritime navigation and radiocommunication equipment and systems;

**.3** check of the system working ability by built-in control system;

**.4** receiver input protection in accordance with 4.6.10 and 4.6.11 of Part IV "Radio Equipment";

**.5** a 5 minute protection interval, for preventing damage to the receiver, its any input and output connections, as well as any receiving equipment input and output;

**.6** continuous work in actual operation conditions;

**.7** use of different number of combined signal receiving channels which receive signals both from the global satellite navigational systems and from radionavigational system earth stations with the use of such wide area differential subsystems as WAAS (Wide Area Augmentation System), EGNOS (European Geostationary Navigation Overlay Service) and MSAS (Multifunctional Satellite Augmentation System), space differential subsystem (Space Base Augmentation System — SBAS), and regional differential subsystems such as Starfix, SkyFix and Eurofix/Scorpio.

**5.11.2** The GNSS GPS (Global Positioning System) receiver intended for navigation purposes on ships of speeds not exceeding 70 knots shall include the following minimum facilities:

antenna capable of receiving GPS signals;

GPS receiver and processor;

means of computing latitude/ longitude position;

data control and interface;

geographical position display and have, if it is required, other forms of output.

**5.11.2.1** The GPS receiver shall comply with the following minimum performance standards and provide for:

**.1** receiving and processing SPS (Standard Positioning Service) signals in SA (Selective Availability) mode of operation, providing position information in latitude and longitude basing on WGS-84 (World Geodetic System 1984) datum in degrees, minutes and thousandths of minutes and time referenced to UTC (Universal Time Coordinated). Means shall be provided for converting the coordinates determined in WGS-84 System into the Reference System of the navigational chart in use. If such a possibility is provided, then the ship's position conversion mode shall be shown on the receiver information display with the indication of the employed system in which the ship's position is determined;

**.2** operation on the L1 (1575,42 MHz) frequency and in C/A (Coarse/Acquisition) code. It is also recommended to provide operation on the L2 (1227,6 MHz) frequency with the use of P (Precise) code;

**.3** static accuracy such that the position of the antenna is determined to within: 100 m (95 %) with HDOP (Horizontal Dilution of Precision) factor equalling 4 or PDOP (Positional Dilution of Precision) factor equalling 6;

**.4** dynamic accuracy such that the position of the ship under the sea states and motion experienced in ships is determined to within: 100 m (95 %) with HDOP factor equalling 4 or PDOP factor equalling 6;

**.5** selecting automatically the appropriate satellite-transmitted signals to determine the ship's position with the required accuracy and update rate;

**.6** acquiring and processing satellite signals with input carrier levels in the range of –130 dBm to –120 dBm. Once the satellite signals have been acquired, the equipment shall continue to operate satisfactorily with satellite signals having carrier levels down to –133 dBm;

**.7** acquiring the first position reading to the required accuracy within 30 min when there is no valid almanac data in the receiver memory;

**.8** acquiring the first position reading to the required accuracy within 5 min when there is valid almanac data in the receiver memory;

**.9** re-acquiring position to the required accuracy within 5 min when there has been a service interruption of 24 h or less, but the energy supply has not been interrupted;

**.10** re-acquiring position to the required accuracy within 2 min when there has been an energy supply interruption of up to 60 s;

**.11** generating and outputting to a display and digital interface a new position solution at least once every 1 s;

**.12** position resolution equal to or better than 0,001 minutes of latitude and longitude;

**.13** COG (Course Over the Ground), SOG (Speed Over the Ground) and UTC outputs, showing these values on the information display and other radio and navigational equipment connected to the receiver. The outputs shall have a validity mark aligned with that on the position output.

The accuracy requirements for COG and SOG shall not be inferior to the relevant performance standards for heading and speed and distance measuring equipment;

**.14** possibility of acquiring and processing correction signals from dGPS (Differential GPS) subsystem in accordance with the ITU (International Telecommunications Union) Recommendations and relevant RTCM (Radio Technical Commission for Maritime Services) Standard. If the GPS receiver is fitted with a facility for acquiring and processing the correction signals from the differential subsystem, its performance standards for static and dynamic accuracy (refer to 5.11.2.1.3 and 5.11.2.1.4) shall be at least 10 m (95 %).

**5.11.2.2** The receiver shall provide indication if the calculated position does not correspond to these operational requirements.

**5.11.2.3** The receiver shall provide a warning within 5 s if:

**.1** HDOP factor exceeds the established limit;

**.2** a new position has not been calculated for more than 1 s.

Under such conditions the last known position and the time of the last valid fix, with the explicit indication of the state so that no ambiguity can exist, shall be output until normal operation is resumed.

**5.11.2.4** If it is impossible to determine the ship's position, an alarm signal shall be given by the receiver.

**5.11.2.5** The receiver shall provide indication of the differential mode of operation in case of:

**.1** receiving differential correction signals;

**.2** considering differential corrections in the displayed ship's position.

**5.11.2.6** The receiver shall provide timely indication if the differential mode of operation cannot be used.

**5.11.2.7** The receiver shall provide the display of the differential mode text message.

**5.11.3** The GNSS GLONASS receiver intended for navigation purposes on ships of speeds not exceeding 70 knots shall include the following minimum facilities:

antenna capable of receiving GLONASS signals;

GLONASS receiver and processor;

means of computing latitude/longitude position;

data control and interface;

geographical position display and have, if it is required, other forms of output.

**5.11.3.1** The GLONASS receiver shall comply with the following minimum performance standards and provide for:

**.1** receiving and processing GLONASS SPS (Standard Positioning Service) signals, providing position information in latitude and longitude basing on PE-90 Reference System in degrees, minutes and thousandths of minutes and time referenced to UTC. Means shall be provided for converting the coordinates determined in PE-90 System into WGS-84 System or into the Reference System of the navigational chart in use. If such a possibility is provided, then the ship's position conversion mode shall be shown on the receiver information display with the indication of the employed system in which the ship's position is determined;

**.2** operation in the Standard Positioning Service mode on the L1 (1602,5625 — 1615,5 MHz) frequencies and in C Code;

.3 static accuracy such that the position of the antenna is determined to within: 45 m (95 %) with HDOP factor equalling 4 or PDOP factor equalling 6;

.4 dynamic accuracy such that the position of the ship under the sea states and motion experienced in ships is determined to within: 45 m (95 %) with HDOP factor equalling 4 or PDOP factor equalling 6 under the sea states and motion experienced in ships;

.5 selecting automatically the appropriate satellite-transmitted signals to determine the ship's position with the required accuracy and update rate;

.6 acquiring and processing satellite signals with input carrier levels in the range of –130 dBm to –120 dBm. Once the satellite signals have been acquired, the equipment shall continue to operate satisfactorily with satellite signals having carrier levels down to –133 dBm;

.7 acquiring the first position reading to the required accuracy within 30 min when there is no valid almanac data in the receiver memory;

.8 acquiring the first position reading to the required accuracy within 5 min when there is valid almanac data in the receiver memory;

.9 re-acquiring position to the required accuracy within 5 min when there has been a service interruption of 24 h or less, but the energy supply has not been interrupted;

.10 re-acquiring position to the required accuracy within 2 min when there has been an energy supply interruption of up to 60 s;

.11 generating and outputting to a display and digital interface a new position solution at least once every 1 s;

.12 position resolution equal to or better than 0,001 minutes of latitude and longitude;

.13 COG (Course Over the Ground), SOG (Speed Over the Ground) and UTC outputs, showing these values on the information display and other radio and navigational equipment connected to the receiver. The outputs shall have a validity mark aligned with that on the position output.

The accuracy requirements for COG and SOG shall not be inferior to the relevant performance standards for heading and speed and distance measuring equipment;

.14 possibility of acquiring and processing correction signals from dGPS (Differential GPS) subsystem in accordance with the ITU Recommendations and relevant RTCM Standard. If the GLONASS receiver is fitted with a facility for acquiring and processing the correction signals from the differential subsystem, its performance standards for static and dynamic accuracy (refer to 5.11.3.1.3 and 5.11.3.1.4) shall be at least 10 m (95 %).

**5.11.3.2** The receiver shall provide indication if the calculated position does not correspond to these operational requirements.

**5.11.3.3** The receiver shall provide a warning within 5 s if:

.1 HDOP factor exceeds the established limit;

.2 a new position has not been calculated for more than 1 s.

Under such conditions the last known position and the time of the last valid fix, with the explicit indication of the state so that no ambiguity can exist, shall be output until normal operation is resumed.

**5.11.3.4** If it is impossible to determine the ship's position, an alarm signal shall be given by the receiver.

**5.11.3.5** The receiver shall provide indication of the differential mode of operation in case of:

.1 receiving differential correction signals;

.2 considering differential corrections in the displayed ship's position.

**5.11.3.6** The receiver shall provide timely indication if the differential mode of operation cannot be used.

**5.11.3.7** The receiver shall provide the display of the differential mode text message.

**5.11.4** The combined GPS GLONASS receiver intended for navigation purposes on ships of speeds not exceeding 70 knots shall include the following minimum facilities:

antenna capable of receiving GPS/GLONASS signals;

GPS/GLONASS combined receiver and processor;

means of computing latitude/ longitude position;

data control and interface;

geographical position display.

**5.11.4.1** The GPS/GLONASS receiver shall comply with the following minimum performance standards and provide for:

**.1** receiving and processing SPS (Standard Positioning Service) signals when the SA (Selective Availability) mode of operation and GLONASS system range determining code are switched on, providing position information in latitude and longitude which is referred to WGS-84 datum in degrees, minutes and thousandths of minutes and time referenced to UTC. Means shall be provided for converting the coordinates determined in WGS-84 Reference System into PE-90 System or into the Reference System of the navigational chart in use.

If such a possibility is provided, then the ship's position conversion mode shall be shown on the receiver information display with the indication of the employed system in which the ship's position is determined;

**.2** operation on the L1 (1575,42 MHz) frequency and in C/A (Coarse/Acquisition) Code of GPS system and on the L1 (1602,5625 — 1615,5 MHz) frequencies and in C Code of GLONASS system;

**.3** static accuracy such that the position of the antenna is determined to within: 35 m (95 %) without considering the differential subsystem signals and — 10 m (95 %) with considering the differential subsystem signals with HDOP factor  $\leq 4$  or PDOP factor  $\leq 6$ ;

**.4** dynamic accuracy such that the position of the ship under the sea states and motion experienced in ships is determined to within: 35 m (95 %) without considering the differential subsystem signals and — 10 m (95 %) with considering the differential subsystem signals with HDOP factor  $\leq 4$  or PDOP factor  $\leq 6$ ;

**.5** selecting automatically the appropriate satellite-transmitted signals to determine the ship's position with the required accuracy and update rate;

**.6** acquiring and processing satellite signals with input carrier levels in the range of  $-130$  dBm to  $-120$  dBm. Once the satellite signals have been acquired, the equipment shall continue to operate satisfactorily with satellite signals having carrier levels down to  $-133$  dBm;

**.7** acquiring the first position reading to the required accuracy within 30 min when there is no valid almanac data in the receiver memory;

**.8** acquiring the first position reading to the required accuracy within 5 min when there is valid almanac data in the receiver memory;

**.9** re-acquiring position to the required accuracy within 5 min when there has been a GPS/GLONASS service interruption of 24 h or less, but the energy supply has not been interrupted;

**.10** re-acquiring position to the required accuracy within 2 min when there has been an energy supply interruption of up to 60 s;

**.11** re-acquiring of a separate satellite signal and using such signal for positioning within 10 s after blocking the signal for a period up to 30 s;

**.12** generating and outputting to a display and digital interface a new position solution at least once every 1 s;

**.13** position resolution equal to or better than 0,001 minutes of latitude and longitude;

**.14** COG, SOG and UTC outputs, showing these values on the information display and other radio and navigational equipment connected to the receiver. The outputs shall have a validity mark aligned with that on the position output.

The accuracy requirements for COG and SOG shall not be inferior to the relevant performance standards for heading and speed and distance measuring equipment;

**.15** possibility of acquiring and processing correction signals from dGPS (Differential GPS) subsystem and dGLONASS (Differential GLONASS) in accordance with the ITU Recommendations and relevant RTCM Standard.

**5.11.4.2** The receiver shall provide indication if the calculated position does not correspond to these operational requirements.

**5.11.4.3** The receiver shall provide a warning within 5 s if:

**.1** HDOP factor exceeds the established limit;

**.2** a new position has not been calculated for more than 1 s.



Under such conditions the last known position and the time of the last valid fix, with the explicit indication of the state so that no ambiguity can exist, shall be output until normal operation is resumed.

**5.11.4.4** If it is impossible to determine the ship's position, an alarm signal shall be given by the receiver.

**5.11.4.5** The receiver shall provide indication of the differential mode of operation in case of:

- .1 receiving differential correction signals;
- .2 considering differential corrections in the displayed ship's position.

**5.11.4.6** The receiver shall provide timely indication if the differential mode of operation cannot be used.

**5.11.4.7** The receiver shall provide the display of the differential mode text message.

**5.11.5** The equipment for receiving signals from the radiobeacons transmitting corrections from the dGPS and dGLONASS differential subsystems intended for navigation purposes on ships of speeds not exceeding 70 knots shall include the following minimum facilities:

- antenna capable of receiving dGPS or dGLONASS correction signals from marine radiobeacons;
- dGPS and dGLONASS correction signals receiver and processor;
- data control and interface.

**5.11.5.1** The equipment for receiving signals from radiobeacons shall comply with the following minimum performance standards and provide for:

.1 reception and processing of dGPS and dGLONASS differential subsystems radiobeacon signals within a frequency range from 283,5 to 325 kHz in compliance with the ITU Recommendations and relevant RTCM Standard;

- .2 facilities for automatic and manual station selection;
- .3 possibility of using data with a delay not exceeding 100 ms after the signal reception;
- .4 acquiring and processing of the signal within 45 s in atmospheric clutter conditions;
- .5 availability of an antenna which is nondirectional in the horizontal plane.

**5.11.6** The Galileo satellite system receiver intended for navigation purposes on ships of speeds not exceeding 70 knots shall include the following minimum facilities:

- antenna capable of receiving Galileo signals;
- Galileo receiver and processor;
- means of accessing the computed latitude/ longitude position;
- data control and interface;
- position display and, if required, other displays/outputs.

If the Galileo satellite system receiver forms part of INS, the composition of the equipment may be reduced and some of the functions may be performed by INS.

**5.11.6.1** The Galileo system receiver shall:

.1 be capable of receiving and processing the Galileo positioning and velocity, and timing signals on: for a single frequency receiver, the L1 frequency alone in the frequency range of 1559 — 1591 MHz (the receiver shall use the ionospheric model broadcast to the receiver by the constellation to generate ionospheric corrections); and for a dual frequency receiver, either on the L1 and E5b frequencies in the ranges of 1164 — 1215 MHz and 1559 — 1591 MHz frequencies or on the L1 and E5a frequencies in the ranges of 1164 — 1215 MHz and 1559 — 1591 MHz frequencies (the receiver shall use dual frequency processing to generate ionospheric corrections).

It is recommended to provide the reception and processing of the Galileo system signal on three frequencies: the L1, E5a and E5b;

.2 provide position information in latitude and longitude which is referred to WGS-84 datum in degrees, minutes and thousandths of minutes and provide time referenced to universal time coordinated UTC;

.3 have static accuracy such that the position of the antenna is determined to within: 15 m horizontal (95 %) and 35 m vertical (95 %) for single frequency operations on the L1 frequency; and 10 m horizontal (95 %) and 10 m vertical (95 %) for dual frequency operations on the L1 and E5a or L1 and E5b frequencies with PDOP factor  $\leq 3,5$ ;

.4 have dynamic accuracy equivalent to the static accuracy under the sea states and motion experienced in ships;

- .5 have position resolution equal or better than 0,001 min of latitude and longitude;
- .6 have timing accuracy such that time is determined within 50 ns of UTC;
- .7 be capable of selecting automatically the appropriate satellite-transmitted signals to determine the ship's position and velocity, and time with the required accuracy and update rate;
- .8 be capable of acquiring satellite signals with input signals having carrier levels in the range of – 128 to – 118 dBm. Once the satellite signals have been acquired, the equipment shall continue to operate satisfactorily with satellite signals having carrier levels down to – 131 dBm;
- .9 be capable of acquiring position, velocity and time to the required accuracy within 5 min when there is no valid almanac data;
- .10 be capable of acquiring position, velocity and time to the required accuracy within 1 min when there is valid almanac data;
- .11 be capable of re-acquiring position, velocity and time to the required accuracy within 1 min when there has been a service interruption of 60 s or less;
- .12 generate and output to a display and digital interface a new position solution at least once every 1 s for conventional craft and at least once every 0,5 s for high-speed craft;
- .13 provide the COG, SOG and UTC outputs, with a validity mark aligned with that on the position output.  
The accuracy requirements for COG and SOG shall not be inferior to the relevant performance standards for the heading and speed and distance measuring equipment and the accuracy shall be obtained under the various dynamic conditions that could be experienced onboard ships;
- .14 provide at least one normally closed contact, which shall indicate failure of the Galileo receiver equipment;
- .15 have a bidirectional interface to facilitate communications so that alarms can be transferred to external systems and so that audible alarms from the Galileo receiver can be acknowledged from external systems.

The interface shall comply with the relevant international standards;

- .16 have facilities to process differential Galileo (dGalileo) data fed to it in accordance with the standards of ITU Recommendations and the appropriate RTCM standard and provide indication of the reception of dGalileo signals and whether they are being applied to the ship's position.

**5.11.6.2** The dGalileo receiver equipment shall also indicate whether the performance of Galileo is outside the bounds of requirements for general navigation in the ocean, coastal, port approach and restricted waters, and in inland waterway phases of the voyage.

**5.11.6.3** The Galileo receiver equipment shall as a minimum:

- .1 provide a warning within 5 s of loss of position or if a new position based on the information provided by the Galileo constellation has been calculated for more than 1 s for conventional craft and 0,5 s for high-speed craft.

Under such conditions the last known position and the time of last valid fix, with explicit indication of the state so that no ambiguity can exist, shall be output until normal operation is resumed;

- .2 use RAIM (Receiver Autonomous Integrity Monitoring) to provide integrity performance appropriate to the operation being undertaken.

**5.11.6.4** For receivers having the capability to process the Galileo Safety of Life Service, integrity monitoring and alerting algorithms shall be based on a suitable combination of the Galileo integrity message and receiver autonomous integrity monitoring (RAIM). The receiver shall provide an alarm within 10 s Time to Alarm (TTA) of the start of an event if an alert limit of 25 m Horizontal Alert Limit (HAL) is exceeded for a period of at least 3 s. The probability of detection of the event shall be better than 99,999 % over a 3-h period (integrity risk  $10^{-5}/3$  h).

**5.11.7 BeiDou satellite navigation system (BDS) receiver.**

**5.11.7.1** The BDS receiver equipment intended for navigation on board the ships having the speed not exceeding 70 knots shall include the following minimum facilities:

- antenna capable of receiving BDS signals;
- BDS receiver and processor;
- means of accessing the computed latitude/longitude position;

data control and interface;  
position display and, if required, other forms of output.

If the BDS receiver forms part of INS, the composition of the equipment may be reduced and some of the functions may be performed by INS.

**5.11.7.2** The antenna design shall be suitable for fitting at a position on the ship which ensures a clear view of the satellite constellation.

**5.11.7.3** The BDS receiver equipment shall conform to the following minimum performance standards:

**.1** be capable of receiving and processing the BDS positioning and velocity, and timing signals, and shall use the ionospheric model broadcast to the receiver by the constellation to generate ionospheric corrections;

**.2** provide position information in latitude and longitude in degrees, minutes and thousandths of minutes.

*Note.* BeiDou uses China Geodetic Coordinate System (CGCS) 2000, which is a realization of the International Terrestrial Reference Frame (ITRF) system and differs from WGS 84 by less than 5 cm worldwide.

Conversion to WGS 84 is not needed for maritime navigation;

**.3** provide time referenced to universal time coordinated UTC (NTSC) (NTSC — China National Time Service Centre);

**.4** be provided with at least two outputs from which position information, UTC, course over ground (COG), speed over ground (SOG) and alarms can be supplied to other equipment. The output of position information shall be based on the World Geodetic System (WGS) 84 datum and shall be transferred in accordance with international standards (refer to IEC 61162). The output of UTC, COG, SOG and alarms shall be consistent with the requirements of 5.11.7.3.15 and 5.11.7.3.17;

**.5** have static accuracy such that the position of the antenna is determined to be within 25 m horizontally (for 95 % probability) and 30 m vertically (for 95 % probability);

**.6** have dynamic accuracy equivalent to the static accuracy under the normal sea states and motion experienced in ships;

**.7** have position information in latitude and longitude in degrees, minutes and thousandths of minutes with a position resolution equal to or better than 0,001 min of latitude and longitude;

**.8** be capable of selecting automatically the appropriate satellite-transmitted signals to determine the ship's position and velocity, and time with the required accuracy and update rate;

**.9** be capable of acquiring satellite signals with input signals having carrier levels in the range of –130 dBm to –120 dBm. Once the satellite signals have been acquired, the equipment shall continue to operate satisfactorily with satellite signals having carrier levels down to –133 dBm;

**.10** be capable of operating satisfactorily under normal interference conditions (refer to 5.1);

**.11** be capable of acquiring position, velocity and time to the required accuracy within 12 min where there is no valid database (almanac data);

**.12** be capable of acquiring position, velocity and time to the required accuracy within 1 min where there is valid database (almanac data);

**.13** be capable of reacquiring position, velocity and time to the required accuracy within 1 min when there has been a service interruption of 60 s or less;

**.14** generate and output to a display and digital interface a new position solution at least once every 1 s for the ships covered by the Rules and at least once every 0,5 s for high-speed craft;

**.15** provide COG, SOG and UTC outputs, with a validity mark aligned with that on the position output. The accuracy requirements for COG and SOG shall not be inferior to the relevant performance standards for heading, speed and distance measuring equipment, and the accuracy shall be obtained under the various dynamic conditions that could be experienced on board ships;

**.16** provide at least one normally closed contact, which shall indicate failure of the BDS receiver equipment;

**.17** have a bidirectional interface to facilitate communication so that alarms can be transferred to external systems and so that audible alarms from the BDS receiver can be acknowledged from external systems. The interface shall comply with the relevant international standards (refer to IEC 61162);

**.18** have the facilities to process differential BDS (DBDS) data fed to it in accordance with the standards of ITU-R9 and the appropriate Radio Technical Commission for Maritime Services (RTCM) standard and provide indication of the reception of DBDS signals and whether they are being applied to the ship's position. When a BDS receiver is equipped with a differential receiver, performance standards for static and dynamic accuracies (refer to 5.11.7.3.5 and 5.11.7.3.6) shall be 10 m (for 95 % probability);

**.19** the BDS receiver equipment shall indicate whether the receiver performance is outside the bounds of requirements for general navigation in the ocean, coastal, port approach and restricted waters, and in inland waterway phases of the voyage.

**5.11.7.4** The BDS receiver equipment shall, as a minimum:

**.1** provide a warning within 5 s of loss of position or if a new position based on the information provided by the BDS constellation has not been calculated for more than 1 s for the ships covered by the Rules and 0,5 s for high-speed craft. Under such conditions the last known position and the time of last valid fix, with the explicit indication of the state allowing for no ambiguity, shall be output until normal operation is resumed;

**.2** use receiver autonomous integrity monitoring (RAIM) to provide integrity performance appropriate to the operation being undertaken;

**.3** provide a self-test function.

**5.11.7.5** Precautions shall be taken to ensure that no permanent damage can result from an accidental short circuit or grounding of the antenna or any of its input or output connections or any of the BDS receiver equipment inputs or outputs for a duration of 5 min.

**5.11.8** The Indian Regional Navigation Satellite System (IRNSS) receiver equipment.

**5.11.8.1** The IRNSS receiver is limited to the following coverage area: area closed by 55°E Longitude, 50°N Latitude and 110°E Longitude, 5°S Latitude.

**5.11.8.2** IRNSS receiver equipment intended for navigation purposes on ships with a speed not exceeding 70 knots, shall include the following minimum facilities:

antenna capable of receiving IRNSS signals;

IRNSS receiver and processor;

means of accessing the computed latitude/longitude position;

data control and interface;

position display and, if required, other forms of output.

If the IRNSS receiver forms part of an approved Integrated Navigation System (INS), then the composition of the equipment can be reduced, and some functions may be provided within the INS.

**5.11.8.3** The antenna design shall be suitable for fitting at a position on the ship which ensures a clear view of the satellite constellation.

**5.11.8.4** The IRNSS receiver equipment shall include the following minimum facilities:

**.1** be capable of receiving and processing the IRNSS positioning and velocity, and timing signals, and shall use the ionospheric model broadcast to the receiver by the constellation to generate ionospheric corrections;

**.2** provide position information based upon WGS-84 coordinates;

**.3** provide time referenced to universal time coordinated UTC;

**.4** be provided with at least two outputs from which position information, UTC, COG, SOG and alarms can be supplied to other equipment. Location data (coordinates) shall be transmitted in accordance with international standards IEC 61162. The output of UTC, COG, SOG and alarms shall be consistent with the requirements of 5.11.8.4.16 and 5.11.8.4.18;

**.5** have static accuracy such that the position of the antenna is determined to be within 25 m horizontally (95 %) and 30 m vertically (95 %);

**.6** have dynamic accuracy equivalent to the static accuracy under the normal sea states and motion experienced in ships;

**.7** have position information in latitude and longitude in degrees, minutes and thousandths of minutes with a position resolution equal to or better than 0,001 min of latitude and longitude;

**.8** have timing accuracy such that time is determined within 100 ns of UTC;

**.9** be capable of selecting automatically the appropriate satellite-transmitted signals to determine the ship's position and velocity, and time with the required accuracy and update rate;

**.10** be capable of acquiring satellite signals with input signals having carrier levels in the range of — 137 dBm to — 127 dBm. Once the satellite signals have been acquired, the equipment shall continue to operate satisfactorily with satellite signals having carrier levels down to — 140 dBm;

**.11** be capable of operating satisfactorily under normal interference conditions (refer to 5.1);

**.12** be capable of acquiring position, velocity and time to the required accuracy within 3 min where there is no valid almanac data;

**.13** be capable of acquiring position, velocity and time to the required accuracy within 2 min where there is valid almanac data;

**.14** be capable of reacquiring position, velocity and time to the required accuracy within 1 min when there has been a service interruption of 60 s or less;

**.15** generate and output to a display and digital interface 22 a new position solution at least once every 1 s for conventional craft and at least once every 0,5 s for high-speed craft;

**.16** provide the COG, SOG and UTC outputs, with a validity mark aligned with that on the position output. The accuracy requirements for COG and SOG shall not be inferior to the relevant performance standards for heading and speed and distance measuring equipment and the accuracy shall be obtained under the various dynamic conditions that can be experienced on board ships;

**.17** provide at least one normally closed contact, which shall indicate failure of the IRNSS receiver equipment;

**.18** have a bidirectional interface to facilitate communication so that alarms can be transferred to external systems and so that audible alarms from the IRNSS receiver can be acknowledged from external systems; the interface should comply with the relevant international standards (refer to IEC 61162);

**.19** have the facilities to process differential IRNSS (D-IRNSS) data fed to it in accordance with the standards of International Telecommunication Union (ITU) and the appropriate Radio Technical Commission for the Marine Services (RTCM) standard and provide indication of the reception of D-IRNSS signals and whether they are being applied to the ship's position. When an IRNSS receiver is equipped with a differential receiver, performance standards for static and dynamic accuracies (refer to 5.11.8.4.5 and 5.11.8.4.6) shall be 10 m (95 %);

**.20** shall timely indicate whether the performance of IRNSS is outside the bounds of requirements for general navigation in the ocean, coastal, port approach and restricted waters, and inland waterway phases of the voyage (refer to IMO resolutions A.1046(27), A.915(22)) and any subsequent amendments, as appropriate.

**5.11.8.5** The IRNSS receiver equipment shall, as a minimum:

**.1** provide a warning within 5 s of loss of position or if a new position based on the information provided by the IRNSS constellation has not been calculated for more than 1 s for conventional craft and 0,5 s for high-speed craft. Under such conditions the last known position and the time of last valid fix, with the explicit indication of the state allowing for no ambiguity, shall be output until normal operation is resumed;

**.2** use receiver autonomous integrity monitoring (RAIM) to provide integrity performance appropriate to the operation being undertaken;

**.3** provide a self-test function.

**5.11.8.6** Precautions shall be taken to ensure that no permanent damage can result from an accidental short circuit or grounding of the antenna or any of its input or output connections or any of the IRNSS receiver equipment inputs or outputs for a duration of 5 min.

**5.11.9** Receiver equipment, capable of combining measurements from multiple GNSS and optional terrestrial radio navigation systems, with or without augmentation, to form position, velocity and time (PVT) solution, can be used for navigation purposes on ships of speeds not exceeding 70 knots.

Performance standards for stand-alone shipborne radionavigation receivers shall be taken into account when conducting type approval for multi-system shipborne radionavigation receiver.

The multi-system shipborne radio navigation receiver determines, as a minimum, the position, COG, SOG and timing either for navigation purposes or as input to other shipboard functions. This information shall be available during static and dynamic operations.

Different methods and techniques are allowed for provision of the PVT data and related integrity information. Where guidelines dealing with the harmonized provision of position, navigation and time (PNT) data as well as integrity monitoring of PNT system in use and provided data products have been approved by IMO, these shall be applied.

**5.11.9.1** Receiver equipment (module A). The equipment shall include the following minimum components and capabilities:

.1 antennas capable of receiving all radio navigation signals required to support the functionality of the receiver equipment;

.2 receiver(s) and processor(s) capable of processing the radio navigation signals required to support the functionality of the receiver equipment;

.3 means of accessing the computed PVT information (e.g. display of latitude, longitude, COG, SOG, time, sources; phase(s) of navigation (refer to IMO resolutions A.915(22) and A.1046(27)));

.4 interface for supplying data controlling/ configuring the receiver;

.5 display;

.6 raw data output, for the provision of additional information (such as range measurements and GNSS navigation data);

.7 indication of the quality and reliability of the computed and distributed PVT data to the user; and

.8 indication of radio navigation system(s) currently used.

**5.11.9.2** The design of the antennas shall be suitable for fitting at position(s) on the ship which provides a satisfactory environment for the reception of all required radio navigation signals. Multi-path compatibility and EMC effects shall be taken into consideration.

**5.11.9.3** The equipment shall be designed:

.1 to mitigate interference from out-of-band sources; and

.2 to provide a means of integrity monitoring for each PVT source employed (e.g. RAIM, CAIM) and multi-source autonomous integrity monitoring.

**5.11.9.4** Operational and functional requirements (module B).

The equipment shall:

.1 operate using civil access navigation signals of at least two independent GNSS recognized by IMO as part of the World-Wide Radio Navigation System (WWRNS), provided in the radio navigation satellite service (space-to-Earth) frequency bands designated in article 5 of the Radio Regulations;

.2 provide the PVT data with the necessary level of resilience and integrity, whether it is used directly as input to other equipment, or provided for use within INS;

.3 where terrestrial radio navigation system(s) signals are provided and used in the protected frequency bands, have the possibility to operate using these signals;

.4 have the facilities to process augmentation data, in accordance with the appropriate methods (refer to ITU-R M.823, RTCM 10410 or other relevant standards);

.5 provide the facility for the user to select or deselect radio navigation and augmentation signals;

.6 be capable of processing the above signals and combining to provide a single PVT solution, including:

position information of the consistent common reference point in latitude and longitude, referenced to an implementation of the International Terrestrial Reference Frame (ITRF), e.g. WGS-84, PZ-90, GTRF, CGCS2000, with coordinates in degrees and minutes to a precision reflective of the accuracy of the position information, up to four decimal places;

COG of the consistent common reference point in degrees to a precision reflective of the accuracy of the calculated course information, relative to true north, up to one decimal place;

SOG of the consistent common reference point in knots to a precision reflective of the accuracy of the calculated speed information, up to two decimal places; and

time, referenced to UTC, to one tenth of one second;

.7 be capable of providing the PVT solution to the required accuracy (refer to IMO resolution A.1046(27)) within:

5 min where there is no valid satellite almanac data (cold start);

1 min where there is valid satellite almanac data (warm start); and

2 min, when subjected to a power interruption or loss of signals of less than 60 s;

**.8** provide time in UTC;

**.9** be capable of meeting the requirements for the phases of navigation outlined in IMO resolution A.1046(27);

**.10** be capable of generating the PVT solution at least once every 0,5 s for high-speed craft (HSC) and at least once every 1 s for conventional ships;

**.11** be capable of assessing whether the performance of the PVT solution (e.g. accuracy and integrity) meets the requirements for each phase of navigation. An alert shall be provided when such assessment cannot be determined;

**.12** provide a caution if after 2 s for HSC or 3 s for conventional ships, equipment is unable to assess the current achieved performance (e.g. accuracy and integrity) with respect to each navigation phase;

**.13** provide a warning, if after 5 s for HSC or 7 s for conventional ships, new PVT data has not been calculated. Under such conditions the last known position and the time of last valid fix, with the explicit indication of the state so that no ambiguity can exist, shall be output until normal operation is resumed;

**.14** if it is not possible to provide a new position update at the next scheduled update, output the last plausible position, SOG, COG, and the time of the last valid fix, with indication of this state so that no ambiguity can exist, until position update is resumed;

**.15** provide an indication of augmentation status, including:

receipt of augmentation signals;

validity of the signals received;

whether augmentation is applied to the position in the PVT solution; and

identification of the augmentation signal(s);

**.16** provide the following information, in alphanumerical form, for the final PVT solution and for each individual source when requested, to a local display (or a separate interfaced display):

position;

COG and SOG;

time;

PVT solution source(s);

assessment of the navigation phase(s), for which performance requirements are supported;

identification of the augmentation signal(s) applied to the position solution; and

any alert information.

**5.11.9.5** Interfacing and integration (module C). The equipment shall provide the following interfaces in accordance with the relevant international standards (IEC 61162):

**.1** at least one interface from which the PVT solution shall be available in the WGS-84 (i.e. including position information, COG, SOG, time, PVT source(s) (available and used), assessment of phase(s) of navigation and augmentation information) can be provided. Means may be provided for transforming the computed position based upon WGS-84 into data compatible with the datum of the navigational chart in use;

**.2** at least one interface from which data from all available sources can be provided (e.g. to INS for enhanced assessment of the PVT information which shall be available in WGS-84);

**.3** an interface for alert management (i.e. with the Bridge Alert Management (BAM)); and

**.4** facilities to accept the input of augmentation signals from at least one source (ITU-R M.823).

No permanent damage can result from an accidental short circuit or grounding of the antenna or any of its input or output connections or any of the inputs or outputs.

**5.11.9.6** Documentation (module D). Documentation for the equipment shall be provided, preferably in an electronic format, and shall include:

**.1** operating manuals, which shall contain an overall function description, including:

multi-system concept and the benefits and limitations of using GNSS and terrestrial radio navigation systems and augmentation (i.e. as source(s) for the PVT solution);

statement, on which GNSS and terrestrial radio navigation systems and augmentation(s) are supported (i.e. as sources for the PVT solution);

statement, on which navigation phases are supported and by which PVT source(s);  
user guidance for receiver adjustments necessary to achieve the navigation phase requirements;  
explanation of the method used for the applied indicators and thresholds;  
an explanation of the fusion process and input selection for multiple systems; and  
description of possible failures and their effects on the receiver equipment;

**.2** installation manuals, which shall contain:

details of the components and the interconnections between them;

details of interfaces and connections for data input/output, and interconnection diagrams;

configuration options and commissioning instructions;

power supply and earthing arrangements; and

recommendations on the physical layout of equipment, including antenna mounting requirements and necessary space for installation and maintenance;

**.3** familiarization material, which shall explain all configurations, functions, limitations, controls, displays, alerts, indications and standard operator checks of the equipment;

**.4** failure analysis (refer to IEC 60182) at the functional level, which shall verify that the equipment is designed using safe design principles and ensuring that the equipment includes "fail-to-safe" actions. The failure analysis shall consider the impact of all failure modes (e.g. those caused by electrical, component, radiofrequency interference or jamming, etc.); and

**.5** information, which shall support maintenance of the equipment.



## **5.12 COMBINED SHIP CONTROL DESKS**

**5.12.1** Controls and indicating instruments of navigational equipment and of other gears for ship handling required by the present or other parts of the Rules and intended for installation in the wheelhouse or in a place from which the ship is operated may be arranged in the combined ship control desks.

**5.12.2** Referred to the controls and indicating instruments mentioned in 5.12.1 are the controls and instruments intended for:

**.1** changing the ship's movement (remote control of main engines, blades of controllable pitch propellers, propeller shaft tachometers, pitch indicators of the CPP, etc.);

**.2** communicating orders and recording commands on changes on ship's movement by electromechanical means (engine telegraphs, reverse recorders, etc.);

**.3** observing navigational features in the area concerned (radar displays, depth indicators, hydrolocators, anchor cable indicators, etc.);

**.4** indicating the values relating to the ship's movement (course, speed, distance, helm, rate of turn, draught indicators, etc.);

**.5** controlling very high frequency radio communication means (remote controls and voice communicating devices);

**.6** external audible and visual signalling (manual controls for whistles, timing units for automatic generation of sound and light signals, remote controls of electric megaphones, masthead flashing light and day signalling lamps keying devices, navigation lights commutators, etc.);

**.7** internal communication and audible signalling (telephones of two-way communication, commutators of service telephone communication, telephones of ship's automatic exchange, commutators of public address system, alarm signalling switches, etc.);

**.8** ensuring survivability of the ship and other essential operations (watertight and fire doors closing, starting of fire fighting systems, control of anchor arrangement, ventilation of accommodation and service spaces and holds, thruster and active rudder, etc.);

**.9** audible and visual signalling to indicate any failure and executive signalling to indicate given command fulfilment (general and individual signalling on failures of essential machinery, systems and gears, signalling on limit values of various parameters, for example, temperature, pressure, revolutions, depths, etc.);

**.10** automated and automatic control of the ship and for making decisions on passing and preventing collisions of ships at sea;

**.11** distribution, switchgear and protection devices provided in Part XI "Electrical Equipment" of the Rules for the Classification and Construction of Sea-Going Ships.

**5.12.3** Provision shall be made in the design of the combined ship control desk for the appropriate panels for free and convenient arrangement of necessary controls and indicating instruments and its inner spaces shall be sufficient for arrangement of inner wiring and devices in accordance with 5.12.2.11, if any.

**5.12.4** The combined ship control desk may be designed both as one common unit and as separate sections, mechanically and electrically connected with one another, the controls and indicating instruments may also be fitted in separately standing desks.

**5.12.5** The dimensions of the combined ship control desk shall be such as to provide the fulfilment of the requirements of 5.12.3 with respect to the devices and instruments built into the desk, as well as the possibility of using controls and observing the instruments, controls and signalling means installed therein when the operator stands facing the ship's bow and to prevent interference for look-outs.

**5.12.6** The requirements of 5.12.5 shall be considered fulfilled, if the following conditions are met:

**.1** the height of the desk vertical panels or boards with controls or indicating and other instruments arranged at the bulkheads with no scuttles therein is such that the above controls and instruments are not lower than 650 mm and not higher than 2000 mm;

.2 the depth of separate sections of the whole desks fitted at the fore bulkhead of the wheelhouse ensures the access to the scuttles.

**5.12.7** The panels of the combined ship control desk may be inclined at any angle ensuring the most exact taking of readings from the indicating instruments and convenient use of controls.

**5.12.8** All controls shall be so installed as to be easily accessible for the personnel and close to the indicators and instruments related thereto or made integral with the latter within the boundaries clearly indicated on the panel. They shall have distinct markings showing the purpose and the direction of the control operation.

**5.12.9** Indicating devices installed on the combined ship control desk shall provide for continuous and automatic information.

The use of indicating devices giving the information only on call of the operator is permitted.

**5.12.10** Where the audible and visual signalling systems capable of indicating any fault in the operation of instruments and machinery are provided, the audible signal shall be clearly heard at any point of the navigation bridge. Signals of various tones shall be used, where necessary.

Controls of emergency systems installed in the desk shall be of red colour. The corresponding portions of scales of instruments intended for indicating emergency and pre-emergency conditions in the systems shall be painted red. In this case:

.1 confirmative signals of starting machinery, systems and arrangements shall function not from the movement or position of controls, but from pulses directly characterizing the working condition of the item of machinery, system or arrangement concerned;

.2 depending on the meaning of light signals, the colour of symbols and letters of indicating inscriptions shall be green for normal operating conditions and red for emergency conditions;

.3 the above colours of light signals shall be used in accordance with the requirements of 5.1.

**5.12.11** Controls arranged in compliance with 5.12.8 shall be so designed that the direction of movement of steering wheel, handle, lever, switch, etc. corresponds to the change of the parameter to be controlled as it is provided by 3.1.3 and 3.1.4, Part VII "Machinery Installations" and Part XI "Electrical Equipment" of the Rules for the Classification and Construction of Sea-Going Ships.

**5.12.12** Controls and devices built in the combined ship control desk shall be fed in compliance with the requirements of 2.3.4 of the present Part or from the distribution gear put in the combined ship control desk and meeting the requirements of Part XI "Electrical Equipment" of the Rules for the Classification and Construction of Sea-Going Ships.

**5.12.13** The combined ship control desk shall be so designed or its separate sections shall be so assembled that controls and indicating instruments vital for the safety of ship's navigation and intended for immediate use under extraordinary circumstances when the ship is under way shall be arranged in the desk to the right from the centre line. This condition will be fulfilled if the controls and indicating instruments listed in 5.12.2.1 to 5.12.2.6 are placed from the starboard to the centre line, in ascending order.

Controls and indicating instruments listed in 5.12.2.7 to 5.12.2.9 as well as in 5.12.2.10 may be arranged to the left from the centre line.

### 5.13 INTEGRATED NAVIGATION SYSTEM

**5.13.1** An integrated navigation system (INS) shall provide proper and safe combining of the ship navigational equipment for joint processing and displaying the obtained information, automatic monitoring of the navigational information integrity and, by taking human factor into consideration, to keep the workload within the capacity of the bridge watch keeping personnel and pilot in order to enhance safe and expeditious navigation and perform functions provided by the INS.

**5.13.2** The performance standards for the INS shall complement the requirements to separate types of the navigational equipment specified in this Part, and each part of the INS shall be in compliance with all applicable requirements of the Rules, including those of this Section.

**5.13.3** The INS shall not impair operational characteristics of the navigational equipment incorporated into the system. The working ability of the navigational equipment shall be ensured in case of malfunction of separate information processing and data exchange units.

If the functions of the equipment connected to the system may be performed with the use of additional units, the impaired working ability and malfunction of these units, shall not, as far as practicable, impair the INS operational characteristics.

**5.13.4** The INS is defined as such if work stations provide multifunctional displays integrating at least the following navigational tasks/functions: route monitoring and collision avoidance, and may provide manual and/or automatic navigation control functions.

The INS comprises navigational tasks such as "route planning", "route monitoring", "collision avoidance", "navigation control data", "navigation status and data display" and "alert management", including the respective sources, data and displays which are integrated into one navigation system.

**5.13.5** It shall be possible to interface the INS with the integrated bridge system.

**5.13.6** These performance standards are based on a modular concept which shall provide for individual configurations and for extensions, if required for meeting the operational requirements and solving navigational tasks. These standards contain at least the following modules:

the module for the requirements for the integration of navigational information (refer to 5.13.7);

the module for the operational/functional requirements for INS based on a task-related structure (refer to 5.13.8);

the module for the requirements of the alert management (refer to 5.13.9);

the module for the documentation requirements (refer to 5.13.10).

**5.13.7 The module for the requirements for integration of navigational information.**

**5.13.7.1** The INS shall combine, process and evaluate data from connected sensors and sources.

**5.13.7.2** The availability, validity and integrity of data exchange within the INS and from connected sensors and sources shall be monitored.

**5.13.7.3** Interfacing to, from, and within the INS shall comply with the International Standard on Interface of Marine Radio and Navigational Equipment and standards for data exchange.

**5.13.7.4** The INS data shall comply with the accuracy and resolution required by applicable performance standards.

**5.13.7.5** Data failing validity checks shall not be used by the INS for functions dependent on these data, unless for cases where the relevant performance standards specifically allow use of invalid data. There shall be no side effects for functions not depending on this data.

**5.13.7.6** When data used by the INS for a function becomes invalid, or unavailable, a warning shall be given.

When data not actually in use by the INS becomes invalid, or unavailable, this shall be indicated at least as a caution.

**5.13.7.7** Received or derived data that is used or distributed by the INS shall be checked for plausible magnitudes of values.

Data which has failed the plausibility checks shall not be used by the INS and shall not affect functions not dependent on this data.

**5.13.7.8** Data latency (timeliness and repetition rate of data) within the INS shall not degrade the functionality specified in the relevant performance standards.

**5.13.7.9** The INS shall ensure that the different types of information are distributed to the relevant parts of the system, applying a "consistent common reference system" (CCRS) for all types of information. Details of the source and the method of processing of such data shall be provided for further use within INS.

**5.13.7.10** The CCRS shall ensure that all parts of the INS are provided with the same type of data from the same source.

**5.13.7.11** The INS shall use a single consistent common reference point for all spatially related information.

For consistency of measured ranges and bearings, the recommended reference location shall be the conning position.

Alternative reference locations may be used where clearly indicated or distinctively obvious. The selection of an alternative reference point shall not affect the integrity monitoring process.

**5.13.7.12** The INS shall support the consistency of thresholds for monitoring and alert functions and, where practicable, shall ensure by automatic means that consistent thresholds are used by different parts of the INS.

A caution may be given when thresholds entered by the bridge team differ from thresholds set in other parts of the INS.

**5.13.7.13** The integrity of data shall be monitored and verified automatically before being used, or displayed.

**5.13.7.14** The integrity of information shall be verified by comparison of the data derived independently from at least two sensors and/or sources, if available.

**5.13.7.15** The INS shall provide manual or automatic means to select the most accurate method of integrity monitoring from available sensors and/or sources.

A clear indication of the sensors and sources of data selected for integrity monitoring shall be provided.

**5.13.7.16** The INS shall provide a warning, if integrity verification is not possible or failed.

**5.13.7.17** Data which fails the integrity monitoring function or data where integrity monitoring is not possible shall not be used for automatic control systems/functions.

The data shall be marked with the source and the results of validity, plausibility checks and integrity monitoring to enable subsequent functions to decide whether their input data complies with their requirements or not.

**5.13.7.18** INS shall provide two user selectable sensor/source selection modes when multiple sensors/sources are available:

- manual sensor/source selection mode;
- automatic sensor/source selection mode.

In manual sensor/source selection mode it shall be possible to select individual sensors/sources for the use in the INS. In case a more suitable sensor/source is available this shall be indicated.

In automatic sensor/source selection mode, the most suitable sensors/sources available shall be automatically selected for the use in the INS. It shall further be possible to manually exclude individual sensors/sources from being automatically selected.

**5.13.8 The module for the operational/functional requirements for INS based on a task-related structure.**

**5.13.8.1** All tasks of the INS shall use the same electronic chart data and other navigational databases such as routes, maps, tide information.

**5.13.8.2** If electronic navigational charts (ENCs) are available, they shall be used as common data source for INS.

**5.13.8.3** The INS shall provide the route planning functions and data as specified in the ECDIS performance standards (refer to 5.15).

The INS shall be capable of supporting procedures for relevant parts of voyage planning and additionally shall provide means for:

- administering the route plan (store and load, import, export, documentation, protection);

having the route check against hazards based on the planned minimum under keel clearance as specified by the mariner;

checking the route plan against manoeuvring limitation, if available in the INS, based on parameters turning radius, rate of turn (ROT), wheel-over and course changing points, speed, time, estimated time of arrival (ETA);

drafting and refining the route plan against meteorological information if available in the INS.

**5.13.8.4** The INS shall provide the route monitoring functions and data as specified in the ECDIS performance standards (refer to 5.15) and shall additionally provide capability for:

optionally overlaying radar video data on the chart to indicate navigational objects, restraints and hazards to own ship in order to allow position monitoring evaluation and object identification;

determination of deviations between set values and actual values for measured under-keel clearance and initiating an under-keel clearance alarm, if fitted;

the alphanumeric display the present values of latitude, longitude, heading, COG, SOG, STW, under-keel clearance, ROT (measured or derived from change of heading);

AIS reports of aids to navigation (AtoNs);

Coastal and NAVAREA navigational warnings;

search and rescue (SAR) warnings;

Coastal and METAREA meteorological warnings;

ice warnings;

Maritime Safety Information overlay functions;

if track control is integrated into the INS, it shall be possible to include the planned track and to provide, monitor and display the track related and manoeuvring data.

**5.13.8.4.1** For navigational purposes, the display of other route-related information on the chart display is permitted, e.g.:

tracked radar targets and AIS targets;

AIS binary and safety-related messages;

initiation and monitoring of man-over-board and SAR manoeuvres (search and rescue and man-overboard modes);

tidal and current data;

weather data;

ice data;

the operator may appropriately filter the display of Maritime Safety Information messages.

**5.13.8.4.2** If available it shall be possible to select on the route monitoring display a predetermined display mode for a "search and rescue" situation that can be accessed upon simple operator command.

In the search and rescue mode a superimposed graphical representation of the datum (geographic point, line or area used as a reference in search planning), initial most probable area for search, commence search point and search pattern chosen by the operator (expanding square search pattern, sector search pattern or parallel track search pattern) with track spacing defined by him shall be presented.

**5.13.8.4.3** If available it shall be possible to select on the route monitoring display a predetermined display mode for a "man-over-board" situation that can be accessed upon simple operator command.

In the man-over-board mode a superimposed graphical presentation of an operator selectable man-over-board manoeuvre shall be presented.

The man-over-board position shall be memorized by a simple operator action.

An urgency manoeuvring procedure shall be available at the display taking set and drift into consideration.

**5.13.8.5** The INS shall provide the collision avoidance functions and data as specified in the radar performance standards (refer to 5.7) and provide additional mandatory functions:

it shall be possible to present less information of ENC database objects than specified in than specified in the standard for the ECDIS display base;

if target information from multiple sensors/sources (radar and AIS; 2 radar sensors) is provided on one task station:

the possibility of target association shall be provided for mutual monitoring and to avoid the presentation of more than one symbol for the same target;

the association of AIS and radar targets shall follow the requirements of 5.7 and Section 6;

common criteria shall be used for raising target related alerts, e.g., CPA/TCPA;

for identical targets unique and identical target identifiers shall be used for presentation on all INS displays.

Where a target from more than one source can be presented on one display the identifier shall be amended as required. Amended target identifiers shall be used for all INS display presentations;

a display may present combined radar signals from more than one radar source. The malfunctions of this additional facility shall not degrade the presentation of the radar source selected as primary. The primary and the other source(s) shall be indicated as such;

optionally, the following information may be displayed:

true scaled ship symbols and CPA/TCPA and bow crossing range (BCR)/bow crossing time (BCT) related to the real dimensions;

chart data from the common database of INS: traffic related object layers.

**5.13.8.6** To support the manual and automatic control of the ship's primary movement the INS navigation control task shall provide the following functionality:

display of data for the manual control of the ship's primary movement;

display of data for the automatic control of the ship's primary movement;

presentation and handling of external safety related messages.

**5.13.8.6.1** For manual control of the ship's primary movement the INS navigation control display shall allow at least to display the following information:

under keel clearance (UKC) and UKC profile;

STW, SOG, COG;

position;

heading, ROT (measured or derived from change of heading);

rudder angle;

propulsion data;

set and drift, wind direction and speed (true and/or relative selectable by the operator), if available;

the active mode of steering or speed control;

time and distance to wheel-over or to the next waypoint;

safety related messages e.g., AIS safety-related and binary messages, Maritime Safety Information messages.

**5.13.8.6.2** For automatic control of the ship's primary movement, the INS navigation control display shall allow at least and as default the display of the following information:

all information listed for manual control;

set and actual radius or rate of turn to the next segment.

**5.13.8.6.3** The navigation control data shall be presented:

in digital and where appropriate in analogue form, e.g., mimic elements, logically arranged on and around a symbolic outline of a ship;

if applicable, together with their "set values";

if applicable and on demand together with a history presentation to indicate the trend of the parameter.

**5.13.8.7** For the task "status and data display" the INS shall provide the following data display functions:

presentation of mode and status information;

presentation of the ship's static, dynamic and voyage-related AIS data;

presentation of the ship's available relevant measured motion data together with their "set values";

presentation of received safety related messages, such as AIS safety-related and binary messages, Application Specific Messages (ASM), Maritime Safety Information messages;

presentation of INS configuration;  
presentation of sensor and source information.

**5.13.8.7.1** The INS may provide optional data display on demand:

tidal and current data;

weather data, ice data;

additional data of the tasks "navigation control" and "route monitoring" and AIS target data.

**5.13.8.7.2** The INS shall provide the following management functions:

setting of relevant parameters;

editing AIS own ship's data and information to be transmitted by AIS messages.

**5.13.8.8** Functional requirements for INS task stations.

**5.13.8.8.1** The number of task stations on the bridge depends on the tasks integrated into the INS. It shall support the simultaneous operation and presentation of at least the minimum set of tasks necessary to meet the carriage requirements of this Part. To specify the required number of task stations the required backup arrangements as mandated by the carriage requirements should be taken into account.

The allocation of the tasks to the task stations shall be sufficiently flexible, to support all navigational situations, and shall be sufficiently simple to support team working and awareness of operator roles. The selection of the task at the task station shall be possible by a simple operator action.

**5.13.8.8.2** A task station shall be provided, if the respective task is part of the INS:

route monitoring;

collision avoidance;

navigation control data.

Means shall be provided to operate the tasks at least at one of the task stations referred to or at least at another task station at the choice of the bridge team and pilot for the tasks of:

route planning;

status and data display;

alert management.

**5.13.8.8.3** For the task of route planning a separate task station may be provided with route planning remote control.

**5.13.8.8.4** If the function of track control is implemented in the INS, it shall be possible to display the planned route graphically on the task stations for:

route monitoring and/or

collision avoidance.

The control and operation of this function by user shall be possible via the same task stations.

**5.13.8.8.5** Only one, clearly indicated task station shall be in control of an automatic function, and only one task station shall at any time be assigned to accept control commands.

It shall clearly be indicated to the bridge team and pilot, if not otherwise obvious, which task station is in control of these functions. It shall be possible to take over the control from a task station. In this case the set control values and limits shall remain unchanged.

**5.13.8.8.5.1** The information relevant for the selected control function shall be available for continuous display, at least upon a single operator command, and shall be presented when an automatic control function is activated or changed.

**5.13.8.8.5.2** It shall be allowed by a single operator action to override or by-pass any automated function, regardless of the operational mode and the failure status of the INS.

**5.13.8.8.5.3** The INS shall resume automatic functions only after an appropriate message and intentional operator action, considering all necessary starting conditions.

**5.13.8.9** Functional requirements for displays of INS.

**5.13.8.9.1** The INS shall comply with the presentation requirements to the ship's displays (refer to Section 6).

**5.13.8.9.2** All essential information shall be displayed clearly and continuously.

Additional navigational information may be displayed, but shall not mask, obscure or degrade essential information required for the display by its primary task, as specified in these performance standards.

**5.13.8.9.3** The INS shall be capable of displaying data available from the sensors.

**5.13.8.9.4** The information shall be displayed together with the indication of its source (sensor data, result of calculation or manual input), unit of measurement and status, including mode.

**5.13.8.9.5** Display and update of essential information available in the equipment as well as safety related automatic functions shall not be inhibited due to operation of the equipment.

**5.13.8.9.6** The INS shall offer default display configurations for the tasks "route monitoring" and "collision avoidance" selectable at each task station to provide the bridge team and pilot with a standardized display.

This configuration shall be accessible by a simple operator action.

The basic requirements for these display configurations are specified in Table 5.13.8.9.6.

Table 5.13.8.9.6

Task "route monitoring"	
Function	Setting
Display category	ECDIS standard display
Selected sea area	Around own ship with appropriate off-set
Range	3 miles
Orientation	True motion, north-up
Manual updates	If applied
Operator's notes	If applied
Position sensor	GNSS (system position provided by INS)
Past track	On
Selected route	Last selected route, including route parameters
Look-ahead time	6 min
Task "collision avoidance"	
Function	Setting
Band	X-band, if selectable
Gain and anti-clutter functions	Automatically optimized
Tuning	Automatically optimized
Range	6 nm
Fixed rings	Off
VRMs	One VRM on
EBLs	One EBL on
Parallel index lines	Off or last setting, if applied
Display mode of the radar picture	True motion, north-up
Off-centering	Appropriate look-ahead
Target trails	On
Past positions	Off
Radar target tracking	Continued
Vector mode	Relative
Vector time	6 min
Automatic radar target acquisition	Off
Graphical AIS reported target display	On
Radar and AIS target fusion	On
Operational alarms (except collision warnings)	Off
Collision warnings	On (limits CPA 2 nm; TCPA 12 min)
Display of maps, navigation lines and routes	Last setting
Display of charts	Off

**5.13.8.9.7** The INS shall provide operational modes for open sea, coastal, confined waters (pilotage, harbour berthing, anchorage).

**5.13.8.9.8** When switching the task from one task station to another, the current display configuration shall be maintained.

It is recommended that the INS provides means to generate pre-defined or operator-defined display modes, that are optimally suitable to the navigation task.



**5.13.8.9.9** The operational mode in use shall be clearly indicated to the bridge team and pilot.

If the mode in use is not the normal mode to fully perform the functions required for the INS, this shall be clearly indicated.

Examples of modes other than the normal mode are:

degraded condition modes, in which the INS cannot fully perform all functions;

"service modes";

simulation mode;

training (familiarization) mode;

other modes, in which the INS cannot be used for navigation.

**5.13.8.9.10** If the system is in a degraded condition this shall be sufficiently clear that the bridge team and pilot can understand the nature of the failure and its consequences.

**5.13.8.9.11** The INS shall indicate the operational status of automated functions and integrated components, systems and/ or subsystems.

**5.13.8.9.12** It shall be possible to display the complete system configuration, the available configuration and the configuration in use.

**5.13.8.9.13** The INS shall provide the means to display:

type of data, source and availability;

type of function and availability;

device identification and its availability.

Ship and system related parameters and settings shall be displayed on demand.

**5.13.8.10** Requirements to the INS human machine interface.

**5.13.8.10.1** For the design and layout of human machine interface of the INS, the requirements of the Rules for Bridge Design, Equipment, Arrangements and Procedures (refer to Appendix) shall be complied with.

**5.13.8.10.2** The design of the system shall facilitate the tasks to be performed by the bridge team and pilot in navigating the ship safely under all operational conditions, avoid potential single point failure by one person during operation and minimize the risk of human error. The operation of the system shall be designed to avoid distraction from the task of safe navigation.

The configuration of the equipment and presentation of information at workstations shall permit observation or monitoring by the bridge team and pilot under all operational conditions.

**5.13.8.10.3** Integrated graphical and alphanumeric display and control functions shall adopt a consistent human machine interface (HMI) philosophy and implementation.

**5.13.8.10.4** The design and implementation of the INS shall ensure that it is simple to operate by a trained user.

**5.13.8.10.5** Information shall be presented consistently within and between different sub-systems. Standardized information presentation, symbols and coding shall be used according to the requirements of Section 6.

**5.13.8.10.6** The INS shall be designed that the basic functions can be easily operated and that the requested manual inputs are consistent throughout the system and can be easily executed. Complex and error-prone interaction within the system shall be avoided.

**5.13.8.10.7** For manual inputs that may cause unintended results, the INS shall request confirmation before acceptance, thus providing a plausibility check.

**5.13.8.10.8** Checks in the dialogue and in the input handling shall be provided to prevent erroneous data or control inputs.

**5.13.8.10.9** Wherever possible, an "undo" function shall be provided.

**5.13.8.11** INS back-up requirements and redundancies.

**5.13.8.11.1** Adequate back-up arrangements shall be provided to ensure safe navigation in case of failure within the INS.

In case of failure of one part or function of the INS, including network failures, it shall be possible to operate each other individual part or function separately. At least the requirements specified for individual equipment adopted by this Part shall be met, as far as applicable.

The back-up arrangements shall enable a safe take-over of the INS functions and ensure that an INS failure does not result in a critical situation.

**5.13.8.11.2** In case of a breakdown of one task station, at least one task station shall be able to take over the tasks.

**5.13.8.11.3** The failure or loss of one hardware component of the INS shall not result in the loss of any one of the INS tasks:

- route planning;
- route monitoring;
- collision avoidance;
- navigation control data;
- status and data display;
- alert management.

**5.13.8.11.4** Where track control is the INS function, this would not require the duplication of heading control or autopilot.

**5.13.8.11.5** The INS shall allow that the back-up component automatically (if possible) takes over the operation of the primary component.

**5.13.8.11.6** For the following sensors/sources of the INS, an approved back-up shall be available:

- electronic position fixing;
- heading measurement;
- speed measurement;
- radar;
- chart database.

**5.13.8.12 System failures and fallback arrangement.**

**5.13.8.12.1** The INS shall, after a failure, and when the back-up activation is not successful support the availability of essential information and functions through the use of appropriate fallback arrangements.

**5.13.8.12.2** In the event of failures of navigational information and to maintain minimum basic operation:

- there shall be a permanent indication of the failed input information and the fallback activated;
- the respective actions of the alert management shall be activated, and;
- the fallback arrangements listed below shall be provided.

In route monitoring mode, in case of failure of heading information (azimuth stabilization), the INS shall display own ship's position and over-ground-motion vector in the chart and not the ship's heading line.

In case of failure of course and speed over ground information, the INS shall display own ship's position and heading line.

In collision avoidance mode, in the case of failure of heading information; speed through the water information; course and speed over ground information; position input information; radar video input information; AIS input information, the INS shall operate as defined by the proposed modular structure for radar performance (refer to 5.7).

In heading/track control modes, the requirements for the applicable control function as specified in the individual performance standards (refer to this Part) shall apply.

**5.13.8.12.3** Normal operation, after use of a fallback arrangement shall only be restored upon confirmation by the operator.

**5.13.8.12.4** The failure or change of a sensor shall not result in sudden changes of control commands or loss of manoeuvring control. This may be accomplished by appropriate integrity checks using the information from several sources.

In case of a sensor or source failure, the system shall provide an alert and indicate (an) alternative sensor(s) or source(s), as available.

If sensors or sources are not able to provide necessary ship status or navigation data for automatic control functions, a dead reckoning procedure shall provide the missing information, as far as practicable.

**5.13.8.12.5** All system related parameters and settings shall be stored in a protected way for reconfiguration of the INS.

The automatic response to malfunctions shall result in the safest possible configuration accompanied by an alert.

**5.13.8.12.6** System failures shall be alerted according to the requirements described in 5.13.9.

Loss of system communication between the alert management and the navigational systems and sensors shall be indicated as a warning at the CAM-HMI.

A system failure of the alert management or the loss of system communication between the alert management and the navigational functions, sources and/or sensors, shall not lead to the loss of the alert announcement functionality of the individual navigational functions, sources/sensors.

**5.13.8.13** Technical requirements to INS.

**5.13.8.13.1** In addition to meeting the relevant requirements of 5.1, the INS shall comply with the following requirements of these performance standards:

**.1** means shall be provided to monitor and to display hardware malfunctions of the INS.

Alerts shall be provided in case of malfunctions;

**.2** processing of raw data from sensors may be part of the INS;

**.3** in case sources perform functions of the INS, these functions and interfaces shall conform with the relevant parts of these performance standards.

An actuator, controller or part thereof is not part of the INS, if it only receives data or commands and does not perform other functions of the INS as required by these standards;

**.4** the operational software shall fulfill the requirements of the relevant international standards related to maritime navigation and communication equipment;

**.5** the INS including the sensors for position, speed, heading and depth shall be supplied: from both the main and the emergency source of electrical power with automated changeover through a local distribution board with provision to preclude inadvertent shutdown; and from a transitional source of electrical power for a duration of not less than 45 s;

**.6** after a power interruption full functionality of the INS shall be available after recovery of all subsystems.

The INS shall not increase the recovery time of individual subsystem functions after power restoration. If subjected to a power interruption, the INS shall, upon restoration of power, maintain the configuration in use and continue automated operation, as far as practicable. Automatic control functions shall only be restored upon confirmation by the operator.

**5.13.9 Alert management.**

**5.13.9.1** The alert management harmonizes the priority, classification, handling, distribution and presentation of alerts, to enable the bridge team to devote full attention to the safe navigation of the ship and to immediately identify any abnormal situation requiring action to maintain the safe navigation of the ship.

The alert management architecture and the acknowledgement concept specified, avoid unnecessary distraction of the bridge team by redundant and superfluous audible and visual alarm announcements and reduces the cognitive load on the operator by minimizing the information presented to which is necessary to assess the situation.

**5.13.9.2** The alert management system shall provide: the means to draw the attention of the bridge team to the existence of abnormal situations, the means to enable the bridge team to identify and address that condition, and also the means to manage all alert related states in a distributed system structure in consistent manner.

Besides, means shall be provided for the bridge team and pilot to assess the urgency of different abnormal situations in cases where more than one abnormal situation has to be handled.

If practicable, there shall be not more than one alert for one situation that requires attention.

**5.13.9.3** The alert management shall have the capability to handle all alerts of navigational equipment comprised by the INS or connected to the INS in identical manner and shall incorporate all alerts that are critical to the safety of navigation.

**5.13.9.4** The logical architecture of the alert management and the handling concept for alerts shall provide the capability to minimize the number of alerts especially those on a high priority level (e.g. using

system knowledge from redundancy concepts inside INS and evaluating inherent necessities for alerts against navigational situations, operational modes or activated navigational functions).

**5.13.9.5** It shall be possible to provide the CAM-HMI at least on the navigating and manoeuvring workstation and allowing the handling by the bridge team.

**5.13.9.6** The audible announcement of alerts shall enhance the guidance of the bridge team to the task stations or displays which are directly assigned to the function generating the alert and presenting the cause of the announcement and related information for decision support, e.g., dangerous target alarms shall appear and have to be acknowledged at the workstation where the collision avoidance function is provided.

**5.13.9.7** As alerts can be displayed at several locations, the system shall be consistent, as far as practicable, with respect to how alerts are displayed, silenced and acknowledged at any one task station of the INS.

**5.13.9.8** The alert management shall distinguish between the three priorities listed:

- alarms;
- warnings and;
- cautions.

Alarms shall indicate conditions requiring immediate attention and action by the bridge team.

Warnings shall indicate changed conditions and shall be presented for precautionary reasons which are not immediately hazardous but which may become so, if no action is taken.

Cautions should indicate a condition which does not warrant an alarm or warning condition, but still requires attention and out of the ordinary consideration of the situation or of given information.

**5.13.9.9** Alerts shall be assigned to a priority level using the criteria for classification:

**.1** criteria for classification of alarms:

conditions requiring immediate attention and action by the bridge team to avoid any kind of hazardous situation and to maintain the safe navigation of the ship; or  
escalation required as alarm from a not acknowledged warning;

**.2** criteria for classification of warnings:

conditions or situations which require immediate attention for precautionary reasons, to make the bridge team aware of conditions which are not immediately hazardous, but may become so;

**.3** criteria for classification of cautions:

awareness of a condition which still requires attention out of the ordinary consideration of the situation or of given information.

**5.13.9.10** Alerts shall be separated for the alert handling in INS into two categories of alerts: A and B.

Category A alerts are specified as alerts where graphical e.g., radar, ECDIS, information at the task station directly assigned to the function generating the alert is necessary, as decision support for the evaluation the alert related condition.

Category A alerts shall include alerts indicating:

- danger of collision;
- danger of grounding.

Category B alerts are specified as alerts where no additional information for decision support is necessary besides the information which can be presented at the CAM-HMI. Category B alerts are all alerts not falling under category A.

A classification in priorities and categories of alerts for INS and for alerts of the individual performance standards is given in Table 5.13.9.10.

**5.13.9.11** The presentation of alarms and warnings shall be in accordance with the requirements of Section 6.

**5.13.9.12** The state of an alert shall be unambiguous for the alert management, the INS and all associated operational and sensor/source displays.

Table 5.13.9.10

Source	Cause	Alarm	Warning	Caution	Category A	Category B
INS	System function lost	+				+
	Integrity verification not possible (5.13.7.16)		+			+
	Invalid information for functions in use (5.13.7.6)		+			+
	Invalid information for functions not in use (5.13.7.6)			+		+
	Different thresholds entered (5.13.7.12)			+		+
	Loss of system communication (5.13.8.12.6)		+			+
Heading control systems	Failure or reduction in power supply	+				+
	Off heading alarm		+		+	
	Heading monitor (deviation from second heading source)		+			+
Track control systems	Early course change indication (track control via waypoints)		+		+	
	Actual course change indication		+	+	+	
	Wheel over line (actual course change indication not acknowledged): alarm back-up navigator alarm	+				
	Failure or reduction in power supply		+			+
	Position monitor		+		+	
	Heading monitor		+		+	
	Sensor failure (heading, position, speed): alarm back-up navigator alarm	+				+
	Cross-track alarm	+			+	
	Course difference (heading deviates from track course)		+		+	
Low speed alarm		+			+	
ECDIS	Positioning system failure		+			+
	Crossing safety contour	+			+	
	Deviation from planned route – off-track alarm	+			+	
	Area with special conditions – cross the boundary		+ <sup>1</sup>	+ <sup>1</sup>	+	
	Approach to critical point		+		+	
	Different geodetic datum		+			+
	System malfunction		+			+
	System malfunction of backup device		+			+
RADAR/ AIS	Target capacity		+			+
	CPA/ TCPA alarm.	+			+	
	Acquisition/activation zone		+		+	
	Lost target alarm		+		+	
	Failure of any signal or sensor in use		+			+

Table 5.13.9.10 — continued

Source	Cause	Alarm	Warning	Caution	Category A	Category B
GNSS	HDOP exceeded			+		+
	No calculation of position					+
	Loss of position		+			+
	Loss of differential signal		+			+
	Differential corrections not applied		+			+
	Differential integrity status			+		
Echo sounder	Depth below keel alarm				+	
	Failure or reduction in power supply		+			+
Gyro compass	System fault		+			+
Bridge watch alarm	Malfunction		+			+
	Power supply failure		+			+
<sup>1</sup> selected by the user.						

**5.13.9.13** The alert management shall distinguish between different announcement states of each individual alarm/warning (unacknowledged or acknowledged alarm/warning).

When an alarm/warning condition is detected, it shall be indicated as unacknowledged alarm/warning and:

initiate an audible signal, accompanied by the visual alarm/warning announcement;

provide a message of sufficient detail to enable the bridge team to identify and address the alarm/warning condition;

may be accompanied by speech output presented at least in English.

An unacknowledged alarm/warning shall be clearly distinguishable from those existing and already acknowledged. Unacknowledged alarms/warnings shall be indicated flashing and by an audible signal.

The characteristics of the audible alarm signal, whether used singly or in combination with speech, shall be such that there is no possibility of mistaking it for the audible signal used for a warning.

It shall be possible to temporarily silence alarms. If an alarm is not acknowledged within 30 s the audible signal shall start again or as specified in the equipment performance standards.

The audible signal, if not temporarily silenced, and the visual signal for an unacknowledged alarm shall continue until the alarm is acknowledged, except specified otherwise in the equipment performance standards.

An acknowledged alarm/warning shall be indicated by a steady visual indication.

The visual signal for an acknowledged alarm/warning shall continue until the alarm condition is rectified.

**5.13.9.14** A caution shall be indicated by a steady visual indication. No acknowledgement shall be necessary for a caution.

A caution shall be automatically removed after the condition is rectified.

A message shall be provided of sufficient detail to enable the bridge team to identify and address the caution condition.

**5.13.9.15** After a time defined by the user, unless otherwise specified by this Part, an unacknowledged alarm shall be transferred to the bridge navigational watch alarm system (BNWAS), if available.

The unacknowledged alarm shall remain visible and audible.

**5.13.9.16** An unacknowledged warning shall be changed to alarm priority, as required by specific requirements for the individual equipment or after 60 s unless otherwise set by the user.

**5.13.9.17** The alert escalation shall be in compliance with the alert escalation requirements of the individual performance standards.

**5.13.9.18** To ensure a consistent presentation of alerts and the presentation of a reduced number of high priority alerts within the INS, the alerts released by navigational functions, sensors, sources shall be presented, as far as practicable, after evaluation with the system knowledge of the INS; the priority of the alert shall be defined in compliance with these performance standards and be assigned and presented consistently for all parts of the INS.

The alert releasing sensor/source or function (system) shall provide the alert related information of the alert message for explanation and decision support, including information for user support.

**5.13.9.19** The audible announcement of category A alerts shall occur at the task stations or displays which are directly assigned to the function generating the alert.

**5.13.9.20** All alerts shall be displayed on the CAM-HMI.

**5.13.9.20.1** The CAM-HMI shall offer the possibility to display category A alerts as "aggravated alerts", i.e., a single visual indication indicates the existence of many alerts on the task station presenting the function, e.g., one alert shall indicate the existence of multiple dangerous target alerts existing at the task station for collision avoidance.

**5.13.9.20.2** The CAM-HMI shall provide the means to announce and indicate alerts to draw the attention of the bridge team, shall have the capability to substitute the audible alert announcement of the individual equipment, except for category A alerts and shall allow to identify alerts, and enable the immediate identification of the alert releasing function or sensor/source.

**5.13.9.20.3** The CAM-HMI shall be designed that alert messages of the different priorities are clearly distinguishable from each other. The alert messages shall be completed with aids for decision making, as far as practicable. An explanation or justification of an alert shall be available on request.

**5.13.9.20.4** The CAM-HMI shall enable an immediate acknowledgement of the alarms and warnings by a single operator's action, except for category A.

**5.13.9.20.5** The CAM-HMI shall be able to display at least 20 recent incidents/faults at the same time.

**5.13.9.20.6** If the CAM-HMI is such that it cannot contain all active messages requiring the bridge team's attention, then there shall be a clear and unambiguous indication that there are additional active messages requiring attention.

It shall be possible to display the additional active messages by a single operator action, and to return to the display containing the highest priority alerts by a single operator action.

**5.13.9.20.7** It shall be possible to temporarily silence all audible alerts at the CAM-HMI.

The audible signal shall be reactivated, if the alert has not been acknowledged within the specified times in 5.13.9.13 and 5.13.9.16 for alarms and warnings.

**5.13.9.20.8** The CAM-HMI shall support the search and identification of alerts in the alert history list. An operator accessible alert history list shall be provided by the CAM-HMI. Access to the alert history list of category B alerts shall be displayed in chronological order.

Access to the alert history list and return to the active alert display shall be possible by a simple operator action.

The system shall provide a clear and unambiguous indication when the alert history list is being accessed and displayed. It shall be possible to keep the content of the alert history list at least for 24 h.

The system shall revert automatically to the active alert display when it detects a new alert condition.

When a category B alert is no longer active, the message shall be kept with its entire content in an alert history list, with the date and time the alert was raised, acknowledged and rectified.

**5.13.9.21** The acknowledgement of alarms and warnings shall only be possible at a HMI (task station) where an appropriate situation assessment and decision support can be carried out.

**5.13.9.22** Provision shall be made for functional testing of alerts, including the system communication between the alert management and the systems and sources/sensors initiating the alerts.

The alert management shall have the capability to provide alerts for failure and loss of functions (systems), sources and sensors. These shall be indicated at the CAM-HMI.

**5.13.9.23** Connected sources, sensors and systems taking part in the alert related communication shall follow a standardized communication concept.

Internal alert related communication within an individual source, sensor and equipment may use an alternative communication concept.

The communication protocol shall allow the implementation of the functions provided by these requirements. In particular, this includes:

transmission of all relevant alert priorities, states, associated quality information, additional alert message information for, e.g., explanation of alert, decision support;

transmission of alert source identity so that originator component and/or function can be determined, as well as it being possible to differentiate between alerts originating from the same device but at different time and also between alerts indicating different conditions from the same device at the same time;

transmission of acknowledgement and silence signals between the device where the alert was silenced or acknowledged and the device where it originates and where it may also have to be silenced/acknowledged;

transmission mechanisms that avoid those signals in one or the other directions are lost (by fully reliable transmissions or by suitable retransmissions);

mechanisms that allow consistent reconnection of a component of the INS system to the system after disconnect at any time and in any alert condition;

in general, mechanisms that allow consistency in the complete INS with regards to alert management.

**5.13.9.24** All systems, sources and sensors incorporated, connected in the INS shall be part of the alert management.

The following equipment and systems, if installed, and not incorporated in the INS, shall be also included in the alert management, as far as possible:

heading information system;

heading/track control system;

electronic position-fixing systems;

speed and distance measuring equipment;

radar with target tracking functions;

ECDIS;

AIS;

echo sounding equipment;

GMDSS equipment;

relevant machinery alarms for early warning.

The bridge navigational watch alarm, if installed, shall be connected to the alert management.

**5.13.10 Documentation requirements module.**

**5.13.10.1** The INS shall be provided on board the ship together with technical documentation.

Operating manual shall include:

an overall functional description of the INS;

the redundancy concept and the availability of functions;

a description of possible failures and their effects on the system (e.g., by using part of the failure analysis);

guidance for the adjustment of the limits for alerts;

the implications of using different reference locations;

details of each data convention and common references: attitude, axis, rotation, reference location of CCRP;

details of the integrity monitoring provided by external sensors or subsystems and their required settings;

details of the mechanism for marking valid, doubtful and invalid data;

for an INS providing automatic control functions (e.g. for heading, track or speed) details of the external override and/or bypassing devices used in the reversionary mode.

The installation manual shall include adequate information to allow the INS to be installed so that it can meet all requirements of this Part and shall include the following:

details of sources, components and the interconnections forming the INS;



details of the interfaces and connections for data import and export and the interconnection diagrams and interfacing details for external parts of the INS and for devices, sensors to be connected;

instructions for the installation and connection of facilities for alert acknowledgement and cancellation including the back-up officer alarm in case of an INS providing automatic control functions (e.g., for heading, track or speed);

the details of the power supply arrangements;

recommendations on the physical layout of equipment and necessary space for maintenance;

for an INS providing automatic control functions (e.g. for heading, track or speed) details of the installation and connection of external override and/or bypassing devices used in the reversionary mode and if rudder angle, heading, propulsion data — e.g, power, propeller pitch, shall not be presented on a display of the INS workstation, the necessary details.

**5.13.10.2** Manufacturer or system integrator of INS shall declare the following information relating to the system configuration, if applicable:

basic system configuration;

interconnecting block diagram (hardware);

sources identification;

override;

priority of control (task stations);

data flow schematic diagram and its interpretation;

default conditions;

back-up arrangement;

redundancy arrangement;

explanation of scope to fulfill requirements of this Part (for one equipment concept);

other useful materials for inspector (such evidence of fulfilled requirements as other means).

**5.13.10.3** A failure analysis, at INS functional level, shall be performed and documented for the INS. The failure analysis shall verify that the INS is designed on "fail-to-safe" principle and that failure of one part of the integrated system shall not affect the functionality of other parts, except for those functions directly dependent on the defective part.

**5.13.10.4** Material enabling onboard familiarization training shall be provided for the INS. The onboard familiarization material shall explain all configurations, functions, limitations, controls, displays, alerts and indications of the INS.

#### **5.14 UNIFIED TIMING SYSTEM**

**5.14.1** The unified timing system station shall ensure:

.1 formation and storage of the time scale and its checking against the International accurate hour's service signals transmitted through the radio channels;

.2 possibility of centralized shifting of displayed readings of the current time within 0 to 23 h with a step of 1 h;

.3 indication of current time readings transmitted to the controllable clock in hours, minutes, seconds.

**5.14.2** The error of the main clock run shall not exceed 0,5 s during twenty-four-hour operation.

## **5.15 ELECTRONIC CHART DISPLAY AND INFORMATION SYSTEM**

**5.15.1** These performance standards shall apply to ECDIS, ECDIS equipment operating in the Raster Chart Display System (RCDS) mode, as well as ECDIS backup arrangements.

**5.15.2** These performance standards shall apply to all ECDIS equipment carried on all ships which are covered by these Rules, as follows:

dedicated standalone workstation;

multifunction workstation as part of integrated navigation system.

**5.15.3** Requirements for structure and format of the chart data, encryption of the chart data as well as the presentation of chart data are within the scope of relevant International Hydrographic Organisation (IHO) standards.

**5.15.4** In addition to the requirements of this Chapter, ECDIS equipment shall meet the applicable requirements of 5.1.

**5.15.5** The Electronic Chart Display and Information System shall be capable of displaying all chart information of the System Electronic Navigational Chart (SENC) originated by the authorized hydrographic offices.

**5.15.6** ECDIS shall facilitate simple and reliable updating of the electronic navigational chart.

**5.15.7** ECDIS shall enable the mariner to execute in a convenient and timely manner all route planning and route monitoring, and it shall be capable of continuously plotting the ship's position.

**5.15.8** The ECDIS display may also be used for the display of radar, radar tracked target information, AIS and other appropriate data layers to assist in route monitoring.

**5.15.9** ECDIS shall have at least the same reliability and availability of presentation as the paper chart published by government authorized hydrographic offices.

**5.15.10** ECDIS shall provide appropriate alarms or indications with respect to the information displayed or malfunction of the equipment.

**5.15.11** ECDIS equipment may operate in the Raster Chart Display System mode.

RCDS mode of operation shall conform to performance standards stipulated in 5.15.108.

**5.15.12** The chart information to be used in ECDIS shall be of the latest edition, as corrected by official updates, of that issued by or on the authority of a Government, government-authorized Hydrographic Office or other relevant government institution, and conform to IHO standards.

**5.15.13** The contents of the SENC shall be adequate and up-to-date for the intended voyage.

**5.15.14** It shall not be possible to alter the contents of the ENC or SENC information transformed from the ENC.

**5.15.15** Updates shall be stored separately from the ENC.

**5.15.16** ECDIS shall be capable of accepting official updates to the ENC data provided in conformity with IHO standards. These updates shall be automatically applied to the SENC. By whatever means updates are received, the implementation procedure shall not interfere with the display in use.

**5.15.17** ECDIS shall also be capable of accepting updates to the ENC data entered manually with simple means for verification prior to the final acceptance of the data.

They shall be distinguishable on the display from ENC information and its official updates and not affect display legibility.

**5.15.18** ECDIS shall keep and display on demand a record of updates including time of application to the SENC. This record shall include updates for each ENC until it is superseded by a new edition.

**5.15.19** ECDIS shall allow the mariner to display updates in order to review their contents and to ascertain that they have been included in the SENC.

**5.15.20** ECDIS shall be capable of accepting both non-encrypted ENCs and ENCs encrypted in accordance with the IHO Data Protection Scheme.

**5.15.21** ECDIS shall be capable of displaying all SENC information. An ECDIS shall be capable of accepting and converting an ENC and its updates into a SENC.

The ECDIS may also be capable of accepting a SENC resulting from conversion of ENC to SENC ashore in accordance with IHO requirements.

**5.15.22** SENC information available for display during route planning and route monitoring shall be subdivided into the following three categories:

- display base;
- standard display;
- all other information.

**5.15.22.1** The display base which shall be permanently shown on the ECDIS display consists of:

- .1** coastline (high water);
- .2** own ship's safety contour;
- .3** isolated underwater dangers of depths less than the safety contour which lie within the safe waters defined by the safety contour;
- .4** isolated dangers which lie within the safe water defined by the safety contour, such as fixed structures, overhead wires, etc;
- .5** scale, range and north arrow;
- .6** units of depth and height; and
- .7** display mode.

**5.15.22.2** The initial standard ECDIS display shall consist of:

- .1** display base;
- .2** drying line;
- .3** buoys, beacons, other aids to navigation and fixed structures;
- .4** boundaries of fairways, channels, etc;
- .5** visual and radar conspicuous features;
- .6** prohibited and restricted areas;
- .7** chart scale boundaries;
- .8** indication of cautionary notes;
- .9** ship's routing systems and ferry routes;
- .10** archipelagic sea lanes.

**5.15.22.3** All other information that can be displayed individually on demand includes:

- .1** spot soundings;
- .2** submarine cables and pipelines;
- .3** details of all isolated dangers;
- .4** details of all aids to navigation;
- .5** contents of cautionary notes;
- .6** ENC edition date;
- .7** most recent chart update number;
- .8** magnetic variation;
- .9** graticule;
- .10** place names.

**5.15.23** ECDIS shall present the standard display at any time by a single operator action.

**5.15.24** When an ECDIS is switched on following a switch off or power failure, it shall return to the most recent manually selected settings for display.

**5.15.25** It shall be easy to add or remove information from the ECDIS display. It shall not be possible to remove information contained in the display base.

**5.15.26** For any operator identified geographical position (e.g. by cursor picking) ECDIS shall display on demand the information about the chart objects associated with such a position.

**5.15.27** It shall be possible to change the display scale by appropriate steps e.g. by means of either chart scale values or ranges in nautical miles.

**5.15.28** It shall be possible for the mariner to select a safety contour from the depth contours provided by the SENC. ECDIS shall emphasize the safety contour over other contours on the display, however:

**.1** if the mariner does not specify a safety contour, this shall default to 30 m.

If the safety contour specified by the mariner or the default 30 m contour is not in the displayed SENC, the safety contour shown shall default to the next deeper contour;

**.2** if the safety contour in use becomes unavailable due to a change in source data, the safety contour shall default to the next deeper contour;

**.3** in each of the above cases, an indication shall be provided.

**5.15.29** It shall be possible for the mariner to select a safety depth. ECDIS shall emphasize soundings equal to or less than the safety depth whenever spot soundings are selected for display.

**5.15.30** The ENC and all updates to it shall be displayed without any degradation of their information content.

**5.15.31** ECDIS shall provide a means to ensure that the ENC and all updates to it have been correctly loaded into the SENC.

**5.15.32** The ENC data and updates to it shall be clearly distinguishable from other displayed information, including those listed below:

**.1** own ship:

past track with time marks for primary track;

past track with time marks for secondary track;

**.2** vector for course and speed made good;

**.3** variable range marker and/ or electronic bearing line;

**.4** cursor;

**.5** event:

dead reckoning position and time (DR);

estimated position and time (EP);

**.6** fix and time;

**.7** position line and time;

**.8** transferred position line and time:

predicted tidal stream or current vector with effective time and strength;

measured tidal stream or current vector with effective time and strength;

**.9** danger highlight;

**.10** clearing line;

**.11** planned course and speed to make good;

**.12** waypoint;

**.13** distance to run;

**.14** planned position with date and time;

**.15** visual limits of lights arc to show rising/ dipping range;

**.16** position and time of "wheel over".

**5.15.33** ECDIS shall provide an indication if:

**.1** the information is displayed at a larger scale than contained in the ENC;

**.2** own ship position is covered by an ENC at a larger scale than provided by the display.

**5.15.34** Radar information and/ or AIS information may be transferred from systems compliant with the relevant standards of this Part. Other navigational information may be added to the ECDIS display. However, it shall not degrade the displayed SENC information and it shall be clearly distinguishable from the SENC information.

**5.15.35** It shall be possible to remove the radar information, AIS information and other navigational information by single operator action.

**5.15.36** ECDIS and added navigational information shall use a common reference system. If this is not the case, an indication shall be provided.

**5.15.37** Transferred radar information may contain a radar image and/ or tracked target information.

**5.15.38** If the radar image is added to the ECDIS display, the chart and the radar image shall match in scale, projection and in orientation.

**5.15.39** The radar image and the position from the position sensor shall both be adjusted automatically for antenna offset from the conning position.

**5.15.40** It shall always be possible to display the SENC information in a "north-up" orientation. Other orientations are permitted (e.g. a "course-up" orientation).

When such orientations are displayed, the orientation shall be altered in steps large enough to avoid unstable display of the chart information.

**5.15.41** ECDIS shall provide for true motion mode (the ship's symbol moves against non-moving chart background). Other modes are permitted.

**5.15.42** When true motion mode is in use, reset and generation of the chart display of the neighbouring area shall take place automatically at own ship's distance from the edge of the display as determined by the mariner.

**5.15.43** It shall be possible to manually change the displayed chart area and the position of own ship relative to the edge of the display.

**5.15.44** If the area covered by the ECDIS display includes waters for which no ENC at a scale appropriate for navigation is available, the areas representing those waters shall carry an indication to the mariner to refer to the paper chart or to the RCDS mode of operation.

**5.15.45** IHO recommended colours and symbols shall be used to represent SENC information.

**5.15.46** The colours and symbols other than those mentioned in 5.15.45, shall comply with the applicable requirements contained in 5.2.

**5.15.47** SENC information displayed at a scale specified in the ENC shall use the specified size of symbols, figures and letters recommended by IHO.

**5.15.48** ECDIS shall allow the mariner to select whether own ship is displayed in true scale or as a symbol.

**5.15.49** ECDIS shall be capable of displaying information for:

- .1 route planning and supplementary navigation tasks; and
- .2 route monitoring.

**5.15.50** The effective size of the chart presentation for route monitoring shall be at least 270 × 270 mm.

**5.15.51** The display shall be capable of meeting colour and resolution recommendations of IHO.

**5.15.52** The method of presentation shall ensure that the displayed information is clearly visible to more than one observer in the conditions of light normally experienced on the bridge of the ship by day and by night.

**5.15.53** If information categories included in the standard display are removed to customize the display, this shall be permanently indicated. It shall be possible to restore the information removed from the standard display. Identification of categories which are removed from the standard display shall be shown on demand.

**5.15.54** It shall be possible to carry out route planning and route monitoring in a simple and reliable manner.

**5.15.55** The largest scale data available in the SENC for the area given shall always be used by the ECDIS for all alarms or indications of crossing the ship's safety contour and of entering a prohibited area, and for alarms and indications according to Table 5.15.84.

**5.15.56** It shall be possible to carry out route planning including both straight and curved segments.

**5.15.57** It shall be possible to adjust a planned route alphanumerically and graphically including:

- .1 adding waypoints to a route;
- .2 deleting waypoints from a route;
- .3 changing the position of a waypoint.

**5.15.58** It shall be possible to plan one or more alternative routes in addition to the selected route. The selected route shall be clearly distinguishable from the other routes.

**5.15.59** An indication is required if the mariner plans a route across an own ship's safety contour.

**5.15.60** An indication shall be given if the mariner plans a route closer than a user-specified distance from the boundary of a prohibited area or a geographic area for which special conditions exist. An indication shall also be given if the mariner plans a route closer than a user-specified distance from a point object, such as a fixed or floating aid to navigation or isolated danger.

The following are the areas for which special conditions exist:

traffic separation zone;  
inshore traffic zone;  
restricted area;  
caution area;  
offshore production area;  
areas to be avoided;  
user defined areas to be avoided;  
military practise area;  
seaplane landing area;  
submarine transit lane;  
anchorage area;  
marine farm/aquaculture;  
PSSA (particularly sensitive sea area).

**5.15.61** It shall be possible for the mariner to specify a cross track limit of deviation from the planned route at which an automatic off-track alarm shall be activated.

**5.15.62** For route monitoring the selected route and own ship's position shall appear whenever the display covers that area.

**5.15.63** It shall be possible to display a sea area that does not have the ship on the display (e.g. for look ahead, route planning), while route monitoring. If this is done on the display used for route monitoring, the automatic route monitoring functions (e.g. updating ship's position, and providing alarms and indications) shall be continuous. It shall be possible to return to the route monitoring display covering own ship's position immediately by single operator action.

**5.15.64** ECDIS shall give an alarm if, within a specified time set by the mariner, own ship will cross the safety contour.

**5.15.65** ECDIS shall give an alarm or indication, as selected by the mariner, if, within a specified time set by the mariner, own ship will cross the boundary of a prohibited area or of a geographical area for which special conditions exist.

**5.15.66** An alarm shall be given when the specified cross track limit for deviation from the planned route is exceeded.

**5.15.67** An indication shall be given to the mariner if, continuing on its present course and speed, over a specified time or distance set by the mariner, own ship will pass closer than a user-specified distance from a danger (e.g. obstruction, wreck, rock) that is shallower than the mariner's safety contour or an aid to navigation.

**5.15.68** The ship's position shall be derived from a continuous positioning system of an accuracy consistent with the requirements of safe navigation. Whenever possible, a second independent positioning source, preferably of a different type, shall be provided. In such cases ECDIS shall be capable of identifying discrepancies between the two sources.

**5.15.69** ECDIS shall provide an alarm when the input from position, heading or speed sources is lost. ECDIS shall also repeat, but only as indication, any alarm or indication passed to it from position, heading or speed sources.

**5.15.70** An alarm shall be given by ECDIS when the ship reaches a specified time or distance, set by the mariner, in advance of a critical point on the planned route.

**5.15.71** The positioning system and the SENC shall be on the same geodetic datum. ECDIS shall give an alarm if this is not the case.

**5.15.72** It shall be possible to display alternative routes in addition to the selected route. The selected route shall be clearly distinguishable from the other routes. During the voyage, it shall be possible for the mariner to modify the selected route or change to an alternative route.

**5.15.73** It shall be possible to display:

**.1** time-labels along a ship's track manually on demand and automatically at intervals selected between 1 and 120 min;

.2 an adequate number of: points, free movable electronic bearing lines, variable and fixed range markers and other symbols required for navigation purposes and specified in 5.15.32.

**5.15.74** It shall be possible to enter the geographical co-ordinates of any position and then display that position on demand. Also, it shall be possible to select any point (features, symbol or position) on the display and read its geographical coordinates on demand.

**5.15.75** It shall be possible to adjust the displayed geographical position of the ship manually. This manual adjustment shall be noted alpha-numerically on the screen, maintained until altered by the mariner and automatically recorded.

**5.15.76** ECDIS shall provide the capability to enter and plot manually obtained bearing and distance lines of position (LOP), and calculate the resulting position of own ship. It shall be possible to use the resulting position as an origin for dead-reckoning.

**5.15.77** ECDIS shall indicate discrepancies between the position obtained by continuous positioning systems and positions obtained by manual observations.

**5.15.78** ECDIS shall store and be able to reproduce certain elements required to reconstruct the navigation and verify the official database used during the previous 12 h.

The following data shall be recorded at one minute intervals:

.1 to ensure a record of own ship's past track: time, position, heading, and speed; and;

.2 to ensure a record of official data used: ENC source, edition, date, cell and update history.

In addition, ECDIS shall record the complete track for the entire voyage, with time marks at intervals not exceeding 4 h.

It shall not be possible to manipulate or change the recorded information.

**5.15.79** ECDIS shall have a capability to preserve the record of the previous 12 h and of the voyage track.

**5.15.80** The accuracy of all calculations performed by ECDIS shall be independent of the characteristics of the output device and shall be consistent with the SENC accuracy.

**5.15.81** Bearings and distances drawn on the display or those measured between features already drawn on the display shall have accuracy no less than that afforded by the resolution of the display.

**5.15.82** The ECDIS system shall be capable of performing and presenting the results of at least the following calculations:

.1 true distance and azimuth between two geographical positions;

.2 geographical position from known position and distance/azimuth;

.3 geodetic calculations such as spheroidal distance, rhumb line, and great circle.

**5.15.83** ECDIS shall be provided with means for either automatically or manually carrying out on-board tests of major functions. In case of a failure, the test shall display information to indicate which module is at fault.

**5.15.84** ECDIS shall provide a suitable alarm or indication of system malfunction, the minimum scope of requirements to which is given in Table 5.15.84.

**5.15.85** ECDIS shall not degrade the performance of any equipment providing sensor inputs. Nor shall the connection of optional equipment degrade the performance of ECDIS below this standard.

**5.15.86** ECDIS shall be connected to the ship's position fixing system, to the gyro compass and to the speed and distance measuring device. For ships not fitted with a gyro compass, ECDIS shall be connected to a marine transmitting heading device.

**5.15.87** ECDIS may provide a means to supply SENC information to external equipment.

**5.15.88** It shall be possible to operate ECDIS and all equipment necessary for its normal functioning when supplied by a main and an emergency source of electrical power.

**5.15.89** Changing from one source of power supply to another or any interruption of the supply for a period of up to 45 s shall not require the equipment to be manually re-initialized.

**5.15.90** Adequate back-up arrangements shall be provided to ensure safe navigation in case of an ECDIS failure.

.1 Facilities enabling a safe take-over of the ECDIS functions shall be provided in order to ensure that an ECDIS failure does not develop into a critical situation.



Table 5.15.84

Section	Requirements	Information
5.15.64	Alarm <sup>1</sup>	Crossing safety contour
5.15.65	Alarm or indication	Area with special conditions
5.15.66	Alarm	Deviation from route
5.15.69	Alarm	Positioning system failure (loss of signal from the system)
5.15.70	Alarm	Approach to critical point
5.15.71	Alarm	Different geodetic datum
5.15.84	Alarm or indication	Malfunction of ECDIS
5.15.28.3	Indication <sup>2</sup>	Default safety contour
5.15.33.1	Indication	Information overscale
5.15.33.2	Indication	Larger scale ENC available
5.15.35	Indication	Different reference systems
5.15.44	Indication	No ENC available
5.15.53	Indication	Customized display
5.15.59	Indication	Route planning across safety contour
5.15.60	Indication	Route planning across specified area
5.15.64	Alarm	The ship is crossing safety contour
5.15.67	Indication	Crossing a danger in route monitoring mode
5.15.83	Indication	System test failure

<sup>1</sup> Alarm — an alarm or alarm system which announces by audible means, or audible and visual means, a condition requiring attention.  
<sup>2</sup> Indication — visual indication giving information about the condition of a system or equipment.

**.2** A back-up arrangement shall provide means of safe navigation for the remaining part of a voyage in case of an ECDIS failure.

**5.15.91** The back-up system shall display in graphical (chart) form the relevant information of the hydrographic and geographic environment which are necessary for safe navigation.

**5.15.92** The back-up system shall be capable of performing the route planning functions, including:

- .1** taking over the route plan originally performed on the ECDIS;
- .2** adjusting a planned route manually or by transfer from a route planning device.

**5.15.93** The back-up system shall enable a take-over of the route monitoring originally performed by the ECDIS, and provide at least the following functions:

- .1** plotting own ship's position automatically, or manually on a chart;
- .2** taking courses, distances and bearings from the chart;
- .3** displaying the planned route;
- .4** displaying time labels along ship's track;
- .5** plotting an adequate number of points, bearing lines, range markers, etc., on the chart.

**5.15.94** If the back-up is an electronic device, it shall be capable of displaying at least the information equivalent to the standard display as defined in this performance standard.

**5.15.95** The chart information to be used in the backup arrangements shall be the latest edition, as corrected by official updates, of that issued by or on the authority of a Government, authorized Hydrographic Office or other relevant government institution, and conform to IHO standards.

It shall not be possible to alter the contents of the electronic chart information.

The chart or chart data edition and issuing date shall be indicated.

**5.15.96** The information displayed by the ECDIS back-up arrangements shall be up-to-date for the entire voyage.

**5.15.97** If an electronic device is used, it shall provide an indication if:

- .1** the information is displayed at a larger scale than that contained in the database;
- .2** own ship's position is covered by a chart at a larger scale than that provided by the system.

**5.15.98** If radar and other navigational information are added to an electronic back-up display, all the corresponding requirements for radar information and other navigation information of this performance standard shall be met.

If an electronic device is used, the display mode and generation of the neighbouring area shall be in accordance with 5.15.40 — 5.15.44.

**5.15.99** The back-up arrangement shall be able to keep a record of the ship's actual track, including positions and corresponding times.

**5.15.100** The back-up arrangement shall provide reliable operation under prevailing environmental and normal operating conditions.

**5.15.101** Accuracy shall be in accordance with requirements from sections 5.15.80 — 5.15.82.

**5.15.102** If an electronic device is used, it shall provide a suitable alarm or indication of system malfunction.

**5.15.103** If an electronic device is used, it shall be designed in accordance with the ergonomic principles of ECDIS.

**5.15.104** If an electronic device is used, colours and symbols shall be in accordance with the colours and symbols requirements of ECDIS, and the effective size of the chart presentation shall be not less than 250 × 250 mm or 250 mm diameter.

**5.15.105** The back-up power supply of an electronic device shall be separate from the ECDIS.

**5.15.106** If an electronic device is used, it shall be connected to systems providing continuous position-fixing capability and not degrade the performance of any equipment providing sensor input.

**5.15.107** If radar with selected parts of the ENC chart information overlay is used as an element of the back-up, the radar shall comply with requirements of section 5.7.

**5.15.108** If ECDIS is used for displaying raster navigation charts (Raster Chart Display System — RCDS) the performance standards specified in this Chapter shall be followed with the exception of 5.15.20, 5.15.22, 5.15.26 — 5.15.29, 5.15.47, 5.15.51, 5.15.53, 5.15.55, 5.15.59, 5.15.60, 5.15.64, 5.15.65 and 5.15.67.

**5.15.108.1** When operating in RCDS-mode, an appropriate portfolio of up-to-date paper charts (APC) shall be carried on board and be readily available to the mariner.

The APC is a suite of paper charts of a scale to show sufficient detail of topography, depths, navigational hazards, aids to navigation, charted routes, and routing measures to provide the mariner with information on the overall navigational environment.

The APC shall provide adequate look-ahead capability.

**5.15.108.2** The RNC used in RCDS shall be of the latest edition of that originated by, or distributed on the authority of, a government authorized hydrographic office and conform to IHO standards. RNCs not on WGS-84 or PE-90 shall carry meta-data (i.e., additional data) to allow geo-referenced positional data to be displayed in the correct relationship to SRNC data.

**5.15.108.3** The contents of the SRNC shall be adequate and up-to-date for that part of the intended voyage not covered by ENC.

**5.15.108.4** It shall not be possible to alter the contents of the RNC.

**5.15.108.5** RCDS shall be capable of displaying all SRNC information.

**5.15.108.6** SRNC information available for display during route planning and route monitoring shall be subdivided into two categories:

**.1** the RCDS standard display consisting of RNC and its updates, including its scale, the scale at which it is displayed, its horizontal datum, and its units if depth and heights;

**.2** any other information such as mariner's notes.

**5.15.108.7** It shall be easy to add to, or remove from the RCDS display any information additional to the RNC data, such as mariner's notes. It shall not be possible to remove any information from the RNC.

**5.15.108.8** There shall always be an indication if the ECDIS equipment is operating in RCDS mode.

**5.15.108.9** It shall always be possible to display the SRNC in "chart-up" orientation. Other orientations are permitted.

**5.15.108.10** IHO recommended colours and symbols shall be used to represent SRNC information.

**5.15.108.11** RCDS shall be capable of displaying, simply and quickly, chart notes which are not located on the portion of the chart currently being displayed.

**5.15.108.12** It shall be possible for the mariner to enter points, lines and areas which activate an automatic alarm. The display of these features shall not degrade the SRNC information and it shall be clearly distinguishable from the SRNC information.

**5.15.108.13** It shall be possible to display a sea area that does not have the ship on the display (e.g. for look ahead, route planning), while route monitoring. If this is done on the display used for route monitoring, the automatic route monitoring functions in 5.15.63 shall be continuous. It shall be possible to return to the route monitoring display covering own ship's position immediately by single operator action.

**5.15.108.14** The RCDS shall only accept positional data referenced to the WGS-84 or PE-90 geodetic datum. RCDS shall give an alarm if the positional data is not referenced to one of these datum. If the displayed RNC cannot be referenced to the WGS-84 or PE-90 datum then a continuous indication shall be provided.

**5.15.108.15** RCDS shall allow the user to manually align the SRNC with positional data. This can be necessary, for example, to compensate for local charting errors.

**5.15.108.16** It shall be possible to activate an automatic alarm when the ship crosses a point, line, or is within the boundary of a mariner entered feature within a specified time or distance.

**5.15.108.17** RCDS shall be capable of performing transformations between a local datum and WGS 84 datum.

**5.15.108.18** RCDS shall provide a suitable alarm or indication of system malfunction, the minimum scope of requirements to which is given in Table 5.15.108.18.

Table 5.15.108.18

Paragraph	Requirement	Information
5.15.66	Alarm	Deviation from route
5.15.108.16	Alarm	Approach to mariner entered feature, e.g. area, line
5.15.69	Alarm	Position system failure (loss of signal from the system)
5.15.70	Alarm	Approach to critical point
5.15.71	Alarm or indication	Different geodetic datum
5.15.84	Alarm or indication	Malfunction of RCDS mode
5.15.108.8	Indication	ECDIS operating in the raster mode
5.15.33.1	Indication	Larger scale information available, or overscale
5.15.33.2	Indication	Larger scale RNC available for the area of the vessel
<p>Note. The definitions of alarms and indicators are given in the Note to Table 5.15.84.</p>		

## **5.16 HEADING CONTROL SYSTEM**

**5.16.1** The heading control system shall enable the ship to keep a preset heading with minimum operation of the ship's steering gear.

**5.16.2** The heading control system shall automatically keep the ship on a preset heading with an accuracy at which an average heading value may differ from the preset value not more than by  $\pm 1^\circ$  at a speed providing ship's normal manoeuvrability. The maximum amplitude of yaw shall not exceed that allowed under manual control.

**5.16.3** The heading control system may be able to perform turns based either on a preset turning radius or a preset rate of turn.

The heading control system may work together with a track control system adjusting its heading for total drift.

**5.16.4** The heading control system shall change to a preset heading without significant overshoot (yaw).

**5.16.5** Provision shall be made in the heading control system for manual change of the heading in the automatic mode without change-over to manual steering.

Two remote stations for manual steering are recommended for the heading control system to make possible an emergency change of the ship's heading from these stations when the system operates in the automatic mode. A single change in the ship's heading in either direction shall not be limited, up to a complete turning. The design of the remote stations for manual steering shall be such that after putting the manual control at the station in the neutral position the ship shall keep the preset heading and further operation of the system in the automatic mode shall be maintained.

The steering wheel, handle or push-button may be used as a manual control.

**5.16.6** A repeater of the gyrocompass or magnetic compass, indicators of the rudder preset and true positions, controls for switching on power supply to the entire heading control system and steering gear motors, sensitivity switches and steering mode change-over controls, controls for presetting ship's turning radius or rate of turn, signal lamps and other controls required for operation of the system shall be installed on the control desk of the system.

It shall be possible to vary illumination of the controls and indicators installed on the control desk of the system.

**5.16.7** The heading control system shall be capable of adapting manually or automatically to different steering characteristics of the ship under various speed and loading conditions depending on weather, and to provide reliable operation under normal operating conditions.

**5.16.8** The heading control system shall prevent unnecessary activation of the rudder due to normal yaw motion in a seaway and enable to preset the maximum rudder angle with indication when the angle of limitation has been reached.

**5.16.9** Any inadvertent alteration of the preset heading shall be prevented.

**5.16.10** The system shall enable change-over from automatic to manual steering and vice versa by a single control located in an easily accessible position.

The following requirements shall be met:

**.1** change-over shall be possible at any position of the rudder, including any failure in the automatic control system;

**.2** change-over shall be effected by one manual control within 3 s;

**.3** adequate indication shall be provided to show which method of steering is in operation.

**5.16.11** When changing over from manual to automatic control the heading control system shall take over the actual heading as the preset heading.

**5.16.12** If the heading control system works as part of a track control system, then switching from track control to automatic heading control shall be provided in the event of any failure in the track control system. The actual heading at the moment of switching shall be taken as the preset heading.

Any inadvertent switching back to track control shall be prevented.

**5.16.13** The heading control system shall be totally self-synchronizing and shall not require any adjustments when a steering mode is changed-over.

The manual steering system built in the control desk of the heading control system shall be simple, reliable, capable of ensuring follow-up mode of the system operation, and shall not use elements of the automatic steering system.

**5.16.14** An alarm both audible with mute function and visual shall be provided in order to indicate failure or reduction in the power supply to the heading control system or heading monitor, as well as when the actual heading deviates from the preset heading beyond a preset limit.

**5.16.15** In case two independent compasses are available, the following shall be provided:

**.1** an alarm both audible with mute function and visual when the pre-set value of permissible discordance between readings of operating and back-up heading monitors is reached;

**.2** a clear indication on the actual heading source.

The heading monitor may be a separate device and is not required to be an integral part of the heading control system.

**5.16.16** The heading control system shall provide an alarm on a failure of any information sensor used in the steering process. All emergency alarms likely to be activated in connection with sensor operation shall be duplicated on the control desk of the heading control system.

**5.16.17** Where the system is not capable for adapting automatically to different environmental conditions and steering characteristics, adequate means for manual adjustments shall be provided on the front panel of the system control desk.

**5.16.18** Normal alterations of heading shall be possible by adjustment of one control only (steering wheel, handle, push-button):

**.1** alteration of the preset heading to starboard shall be effected by turning the heading setting control clockwise or titling it to the right-hand side.

**.2** alteration of the present heading to port side shall be effected by turning the heading setting control counter-clockwise or titling it to the left-hand side. Actuation of any other control shall affect the preset heading of the ship.

**5.16.19** Where remote control stations are provided, facilities for the delegation of control to remote station shall be incorporated in the master station.

Controls at remote positions shall be similar to those on the master station and have illumination which may be varied as required by 5.16.6.

**5.16.20** Provision shall be made for connection of the heading control system with suitable source of speed information.

Connection of the heading control system with information sources shall comply with 5.1.

### **5.17 SHIP'S TRACK CONTROL SYSTEM**

**5.17.1** The ship's track control system in conjunction with their sensors of position, heading and speed information shall, regarding manoeuvring characteristics, provide automatic keeping a ship on a pre-planned track over ground under various operational conditions and at ship's speed from minimum manoeuvring speed up to 30 knots, and at ship's rate of turn not greater than 10°/s.

**5.17.2** A track control system shall be automatically able to steer the ship from her position to a preset waypoint or along a preset sequence of waypoints.

**5.17.3** The system shall allow the watch navigator to start automatic track control only if the safe approach manoeuvre to the pre-set track is provided by the following:

- .1 the ship's position;
- .2 the difference between track course and actual heading;
- .3 ship's manoeuvrability.

**5.17.4** The radio and navigation systems receiver used by the ship's track control system shall meet requirements in 5.11.

**5.17.5** Means shall be provided for continuous monitoring the ship's position by another independent positioning system.

**5.17.6** When following along the pre-set sequence of waypoints, an alarm shall be given not later than 1 min before the course change and at the moment of manoeuvre starting.

**5.17.7** The ship's track control system shall provide means for the watch navigator to confirm the course change at wheel-over. Without the confirmation, the ship shall follow automatically the preset track.

An alarm actuation shall be provided if a wheel over alarm was not confirmed within 30 s.

**5.17.8** A sequence of waypoints of a pre-set track shall not be modified until:

- .1 the pre-planning of the new track is completed; and
- .2 the requirements of 5.17.3 are fulfilled.

**5.17.9** The track control system shall ensure the automatic manoeuvre of the ship when sailing from one leg of a pre-set track to another basing:

- .1 on a pre-set turn radius;
- .2 on a pre-set rate of turn and manoeuvrability of the ship.

**5.17.10** The ship's track control system shall provide its adaptation (manual or automatic) to different steering characteristics of the ship under various weather, speed and loading conditions, and also ensure reliable functioning in service.

**5.17.11** The ship's track control system may be operated in heading control mode. In this case, the requirements in 5.16 shall be fulfilled.

When changing over from track control to heading control, the actual heading shall be taken over by the system as the pre-set heading.

Changing over of system functioning modes shall be performed by a single operator action from the convenient and readily accessible position.

A possibility of changing the system functioning modes by chance shall be excluded.

Clear indication on the system control panel shall be provided to show which method of ship's steering is in operation.

**5.17.12** The system shall provide the change over from track control to manual steering and back by a single operator action from the convenient and readily accessible position. In this case the following requirements shall be fulfilled:

- .1 possibility of change over at any rudder angle and under any conditions including failure in the automatic steering system;
  - .2 carrying out the change over by a single action within time not exceeding 3 s;
  - .3 provision of clear indication on the system control panel of functioning mode in use.
- A possibility of return to ship's track control mode by chance shall be excluded.

**5.17.13** When changing over from manual steering to automatic steering, the system shall ensure bringing the ship to the preset track.

**5.17.14** The separate or built-in repeater shall be provided to indicate the actual value of ship's heading.

**5.17.15** An audible alarm, that can be cancelled, and a visual one shall be provided to warn about failure or reduction in power supply of the ship's track control system and of the course indication system, and also about an excess of a pre-set values of the ship's permissible deviation from a pre-set track or course depending on the system functioning mode in use.

**5.17.16** The ship's track control system shall provide:

.1 an alarm with an acknowledgement function in case of failure or fault of the position fixing and course indication system;

.2 a preparation of guidance for changing over to a safe steering mode.

An actuation of an alarm shall be provided if warning signal about fault or failure of the position fixing and course indication systems was not acknowledged within 30 s.

It shall not be possible for the system to use information from faulty sensors.

**5.17.17** The system shall provide an alarm in case when:

.1 the actual position of the ship deviates from the preset track beyond a preset cross track limit;

.2 the ship's speed through the water is lower than a predefined limit necessary for steering the ship.

**5.17.18** The track control system shall provide a possibility to calculate heading between subsequent pre-set waypoints, and also a turn radius or rate of turn. In this case the system shall regard all pre-set track control related limits, conditions of alarm actuation and other ship's steering parameters.

**5.17.19** The following information shall be continuously displayed on the system control panel:

.1 mode of ship's steering (heading or track control);

.2 sensors of actual position of the ship, its heading and speed;

.3 status and failure of sensors;

.4 track course and actual heading;

.5 actual ship's position, cross track distance and speed;

.6 TO-waypoint (waypoint which the ship is approaching) and NEXT-waypoint (waypoint following the TO-waypoint);

.7 time and distance to TO-waypoint;

.8 calculated track course following turn performance;

.9 selected track identification.

Items 5.17.19.4, 5.17.19.5, 5.17.19.7 and 5.17.19.8 shall be displayed numerically.

**5.17.20** The following information shall be provided on demand:

.1 a list of pre-planned waypoints including waypoints numbers, co-ordinates, courses and distances between waypoints, calculated turn radii or rates of turn;

.2 all track control related pre-set limits and other steering parameters. In this case, functionally related values (such as pre-set and actual, etc.) shall be displayed as a pair of data.

**5.17.21** In case of failure of the track control mode or the position fixing system in use, the track control system shall:

.1 automatically switch over to the heading control mode if it is available. In doing so the actual heading at the instant of switching over shall be taken as the pre-set heading;

.2 maintain the rudder angle if the heading control is not available.

**5.17.22** In case of the course indication system failure, the track control system shall ensure actuating alarms required in 5.17.15 to 5.17.17 and maintaining the rudder angle.

## **5.18 UNIVERSAL SHIPBORNE AUTOMATIC IDENTIFICATION SYSTEM (AIS)**

**5.18.1** The universal shipborne automatic identification system (AIS) shall be capable of operating in the following modes:

**.1** an autonomous mode for operation in all areas of the ship's service ensuring continuous automatic self organizing mutual exchange of static and dynamic (navigational) information between ships and between ships and shore-based stations. This mode shall be capable of being switched to/from one of the following alternate modes;

**.2** an assigned mode for operation in an area subject to a competent authority responsible for traffic monitoring such that the static and dynamic information transmission interval and time slots may be set by that authority and/or scheduled;

**.3** a polling mode for automatic transfer of static and dynamic information, as well as voyage related information in response to interrogation from a ship or competent authority.

**5.18.2** For the purpose of identification, the Maritime Mobile Service Identity (MMSI) number assigned to the ship shall be used in the AIS.

**5.18.3** The AIS shall comprise:

**.1** a communication processor, capable of operating over a range of maritime frequencies, with an appropriate channel selecting and switching method, in support of both short (VHF) and long range applications;

**.2** at least one transmitter, two time-division multiple access (TDMA) receivers using a universal time scale, and one digital selective call (DSC) receiver tuned to Maritime Mobile Service's VHF channel 70;

**.3** a means of processing data from an electronic position-fixing system which provides a resolution of one ten thousandth of a minute of arc and uses the WGS-84 datum;

**.4** a means to automatically input data from the dynamic information sensors;

**.5** a minimum keyboard and display (MKD) to enable manual input, updating and retrieving of data;

**.6** a means of error checking the transmitted and received data;

**.7** built-in test equipment;

**.8** internal Global Navigational Satellite System (GNSS) receiver to determine the Universal Coordinated Time (UTC) for synchronization purposes.

**5.18.4** The AIS shall be capable of:

**.1** providing the ship's manoeuvring and positional information (dynamic information) at intervals specified in Table 5.18.17;

**.2** providing static information periodically and automatically to a competent authority and other ships fitted with AIS;

**.3** receiving and processing information from a competent authority and other ships;

**.4** responding to high priority or safety related calls with a minimum of delay.

Additionally, in the event of failure of the main source of ship's positional information, it is recommended to provide for automatic switching to the internal Global Navigational Satellite System receiver for positional information. In this case, an appropriate built-in integrity tests (BIIT) indication shall be output and the position data shall be continuously available on the minimum display.

**5.18.5** The AIS shall be capable of operating in the VHF frequency band of Maritime Mobile Service (156,025 to 162,025 MHz) with the frequency spacing between 25 kHz and 12,5 kHz channels.

After switching on, the AIS shall by default be capable of operating on two international simplex channels: AIS 1 — 161,975 MHz (channel 2087), AIS 2 — 162,025 MHz (channel 2088).

The AIS shall be capable of switching over to other channels by one of the following three methods:

**.1** manual switching;

**.2** automatic switching as required by shore-based station in the TDMA format;

**.3** automatic switching as required by shore-based station in the DSC format.



**5.18.6** The AIS shall be capable of transmitting and receiving the following information:

**.1** static:

- IMO number assigned to the ship;
- call sign and name;
- length and beam;
- type of ship;
- location of position-fixing antenna on the ship (aft of bow and port or starboard of centerline);

**.2** dynamic:

- ship's position with accuracy indication and integrity status;
- time in UTC;
- course over ground (COG);
- speed over ground (SOG);
- heading (according to gyrocompass);
- rate of turn (where rate of turn indicator is available);
- navigational status (underway, at anchor, not under command (NUC), limited freedom to manoeuvre, at berth, grounded, trawling, etc. — manual input);

**.3** voyage related:

- ship's draught;
- hazardous cargo and its type (as required by a competent authority);
- destination and estimated time of arrival (ETA) (at master's discretion). The name of the port of destination shall comply with the International Code — UN/LOCODE;

**.4** safety-related messages (short messages relevant to maritime safety and containing important navigational and meteorological notices).

**5.18.7** In the autonomous mode, the AIS shall be capable of transmitting information at the following intervals, depending on the information type and the ship's navigational status:

**.1** static information:

- every 6 min;
- on request;

**.2** dynamic information:

dependant on the navigational status of own ship according to Table 5.18.7.2;

Table 5.18.7.2

Ship's navigational status	Dynamic information reporting interval
Ship at anchor or moored and not moving faster than 3 knots	3 min
Ship at anchor or moored and moving faster than 3 knots	10 s
Ship with a speed of between 0 to 14 knots	10 s
Ship with a speed of between 0 to 14 knots and changing course	3,3 s
Ship with a speed of between 14 to 23 knots	6 s
Ship with a speed of between 14 to 23 knots and changing course	2 s
Ship with a speed of greater than 23 knots	2 s
Ship with a speed of greater than 23 knots and changing course	2 s

**.3** voyage-related information:

- every 6 min;
- when data have been amended;
- on request;

**.4** safety-related messages:

as required.

The AIS shall be able to handle up to 4500 reports per min when operating on two channels.

**5.18.8** The input and transmitted data shall be protected against unauthorized alteration.

**5.18.9** The AIS installation shall be operational within 2 min of switching on.

**5.18.10** Means shall be provided to automatically record all periods when the AIS installation is non-functioning in a non-volatile memory.

**5.18.11** The minimum keyboard and display (MKD) of the AIS shall comply with the following requirements:

**.1** display of at least 3 lines of data. Each line shall clearly display at least the ships' name, bearing and range;

**.2** horizontal scrolling of bearing and range is not allowed;

**.3** the displayed information shall be clearly visible under all possible conditions of illumination at the place where it is located. Where needed, display lighting shall be provided;

**.4** provision shall be made for manual input of voyage-related information and safety-related messages;

**.5** provision shall be made for displaying the alarms information, indications as a result of built-in integrity test, received safety related messages and received long range interrogations.

### **5.19 SOUND RECEPTION SYSTEM**

**5.19.1** The sound reception system shall be capable of receiving outside sound signals from all directions in the audio band 70 Hz to 820 Hz, of reproducing those signals acoustically inside the wheelhouse indicating therewith the direction of the sound signals source.

Reception of outside sound signals in the extended frequency audio band from 70 Hz to 2100 Hz may be permitted.

**5.19.2** The volume of outside sound signals reproduced in the wheelhouse shall be adjusted. In this case, the minimum sound pressure level shall be 10 dB(A) above the bridge noise level.

**5.19.3** The visual indicator of a sound signals reception system shall indicate a direction not later than in 3 s after reception of the incoming sound signal by the system.

**5.19.4** The sound reception system may be provided with self-test program to ensure functional test of microphones and the system itself.

When transmitting the warning via public address system or tyfon the microphones of sound reception system may be automatically switched off.

## **5.20 VOYAGE DATA RECORDER (VDR)**

**5.20.1** VDR shall continuously and automatically maintain sequential records of preselected data items obtained from the ship devices and systems relating to the status and operational modes of the ship's equipment, command and control of the ship, and environment.

**5.20.2** The method of recording shall ensure that the various data items can be co-related in date and time during playback on suitable equipment.

**5.20.3** The VDR shall include functions to perform a performance test at any time (annually, following repair or maintenance work) to the VDR or any signal source providing data to the VDR, as well as to check the recorded data. This test shall ensure that all the required data items are being correctly recorded.

**5.20.4** The final recording medium is an integral part of the VDR and shall consist of the following items on which the data is recorded such that access to any one of them will enable the data to be recovered and played back:

- fixed recording medium;
- float-free recording medium; and
- long-term recording medium.

**5.20.4.1** The fixed recording medium shall be installed in a fixed protective capsule which shall meet the following requirements:

- .1** be fixed to the open deck of the ship;
- .2** be capable of being accessed following an incident but secure against a physical or electronically manipulated change or deletion of recorded data;
- .3** maintain the recorded data for a period of at least two years following termination of recording;
- .4** maximize the probability of survival and recovery of the recorded data after any incident, including survival against the following:

- shock (a half sine-wave pulse of 50 g, with a duration of 11 ms);
- penetration (a mass of 250 kg with a pin of 100 mm diameter, dropped from a height of 3 m);
- low temperature fire of 260 °C nominal for 10 h);
- high temperature fire of 1100 °C for 1 h);
- 3 m sea water immersion for 30 days;
- 6000 m deep-sea water immersion for 24 h;

**.5** be fitted with an appropriate device to aid location under water, e.g. an acoustic underwater beacon attached to the case of the fixed protective capsule and indicating location thereof, and operating in the frequency band of 37,5 kHz (frequency band of 25 to 50 kHz) with battery life of at least 90 days.

The protective capsule case shall be of a highly visible colour and marked with retro-reflective materials, as well as with a clearly seen inscription in English: "VOYAGE DATA RECORDER — DO NOT OPEN — REPORT TO AUTHORITIES".

**5.20.4.2** The float-free recording medium shall be installed in float-free capsule which shall meet all the following requirements:

- .1** be capable of being accessed following an incident but secure against a physical or electronically manipulated change or deletion of recorded data;
- .2** be fitted with means to facilitate grappling and recovery;
- .3** be so constructed as to minimize risk of damage during recovery operations;
- .4** maintain the recorded data for a period of at least six months following termination of recording;
- .5** be constructed as to comply with the requirements to COSPAS-SARSAT satellite emergency position-indicating radio beacons specified in 9.1 and 9.2, Part IV "Radio Equipment";
- .6** be provided with automatically activated flashing light with a luminous intensity of 0,75 cd and installed on the capsule, as well as with a device capable of transmitting an initial locating signal and further locating homing signal for at least 48 h over a period of not less than seven days/168 h.

**5.20.4.3** The long-term recording medium shall provide access via the standard interface to the data held on it but be secured against a physical or electronically manipulated change or deletion of recorded data.

The operating manual of the long-term recording medium and instruction describing the means of interfacing with it shall be kept at a prominent position as close to the long-term recording medium as practicable.

**5.20.5** The VDR shall provide recording and storage of data items. The time for which all stored data items are retained shall be the following:

- at least 30 days (720 h) on the long-term recording medium;
- at least for 48 h on the fixed recording medium; and
- at least for 48 h on the float-free recording medium.

When the periods of data recording and storage exceed the prescribed ones, the data items which are older than those mentioned above may be overwritten with new data.

**5.20.6** It shall be possible to record, as a minimum, the following data items:

**.1** date and time in steps ensuring a reconstruction of events sequence. Date and time, referenced to Universal Time Coordinate (UTC), shall be obtained from a source external to the ship and an internal clock (synchronized with valid date and time data) with indication, which source is in use. During times of a loss of the external source, the internal clock shall be used;

**.2** latitude and longitude of ship's position derived from a receiver of radio navigation systems with indication of its type and operational mode, as well as the datum used;

**.3** ship's heading as indicated by the ship's gyrocompass or magnetic compass;

**.4** ship's speed as indicated by the ship's log(s) including an indication if it is through the water or over the ground;

**.5** conversations, commands and sound signals on the bridge, and also announcements over public address system;

Microphones shall be positioned on the bridge covering all work stations so that conversation is recorded. The recording shall be such that, on playback, a normal speaking voice shall provide adequate intelligibility while the ship is performing its normal operations.

This shall be achieved through the use of at least two channels of audio recording to ensure selection of valid signal from any noise, including noise from faulty equipment or mounting, or wind. Microphones positioned outside on bridge wings, shall be recorded on at least one additional separate channel;

**.6** communications with other ships, objects and shore-based services using VHF radio equipment shall be recorded on an additional separate channel to those referred to in 5.20.6.5;

**.7** radar and auxiliary navigational data displayed on both radar display units. The recording method shall be such that, on playback, it is possible to present a faithful replica of the entire radar display that was on view at the time of recording, albeit within the limitations of any bandwidth compression techniques that are essential to the working of the VDR;

**.8** the ECDIS screen display in use at the time as the primary means of navigation (where a ship is fitted with ECDIS). The recording method shall be such that, on playback, it is possible to present a faithful replica of the entire ECDIS display that was on view at the time of recording, albeit within the limitations of any bandwidth compression techniques that are essential to the working of the VDR and in addition the source of the chart data and the version used;

**.9** depth under keel, the depth scale currently being displayed and other status information;

**.10** all mandatory alarms on the bridge or as received from the bridge alert management system (BAM), if installed, recorded as individually identified alarms;

**.11** rudder and steering gear order and response. This shall include status and settings of heading or track control system, if fitted, and indicate the control station, mode, and power unit(s) in use;

**.12** engine and thruster order and response. This shall include the positions of any engine telegraphs or direct engine/propeller controls and feedback indications on the bridge, if fitted, including ahead/astern indicators and indicate the control station in use.

This shall also include any thrusters, if fitted, and indicate the control station in use.

**.13** status of sea openings of ship's hull. This shall include all mandatory status information required to be displayed on the bridge;

**.14** watertight and fire door status. This shall include all mandatory status information required to be displayed on the bridge;

**.15** accelerations and hull stresses (where a ship is fitted with suitable sensors, as well as with hull stress and response monitoring equipment);

**.16** wind speed and direction (where a ship is fitted with suitable sensors) including its true or relative status;

**.17** all automatic identification system (AIS) data;

**.18** rolling motion (where a ship is fitted with an electronic inclinometer). The recording method shall be such that the rolling motion can be reconstructed during playback;

**.19** data block defining the configuration of the VDR and the sensors to which it is connected. This data shall be written into the final recording medium during commissioning of the VDR. The data block shall be maintained up to date with respect to the vessel installation. It shall include details on the manufacturer, type and version number of a sensor, the identification and location of the sensor and the interpretation of the sensor data. The possibility of changes in the data block shall be avoided except the cases related to data corrections due to actual changes in the VDR configuration and sensors. This configuration data shall be permanently retained in the final recording media and protected from modification other than by a duly authorized person following any change to the configuration;

**.20** the ship's log book data (where a ship is fitted with an electronic log book).

**5.20.7** Optionally, additional items may be recorded provided that the requirements for the recording and storage of the specified selections are not compromised.

**5.20.8** The equipment shall be so designed that, as far as is practical, it is not possible to manipulate the amount of data being recorded by the VDR, the data itself nor the data which has already been recorded.

Any attempt of an unauthorised access to VRD operation shall be recorded.

**5.20.9** The recording method shall be such that each item of the recorded data is checked for integrity and an alarm given if a non-correctable error is detected.

**5.20.10** If the ship's source of electrical power supply fails, the VDR shall continue to record bridge audio from the dedicated reserve power source (e.g. using its own accumulator batteries) for a period of 2 h. At the end of this 2-h period all recording shall cease automatically.

**5.20.11** Malfunctions or failure of VDR shall not affect the operation of the data sensors interfaced thereto.

**5.20.12** The VDR shall provide an interface for downloading the stored data and playback the information to an external computer. The interface shall be compatible with an internationally recognized format, such as Ethernet, USB, Fire Wire or equivalent. It shall be possible to perform a download of the recorded data for a user-defined period of time.

**5.20.13** A copy of the software programme providing the capability to download the stored data and playback the information onto a connected external laptop computer and for the playback of the data shall be provided for each VDR installation.

The software shall be compatible with a standard operating system available with commercial-off-the-shelf laptop computers and provided on a portable storage device such as CD-ROM, DVD, USB-memory stick, etc.

**5.20.14** In the technical documentation delivered together with VDR the instructions for connecting the external laptop computer to the S-VDR and for executing the software shall be provided.

**5.20.15** The portable storage device containing the software, the instructions and any special (not commercial-off-the-shelf) parts necessary for the physical connection of the external laptop computer, shall be stored within the main input of the VDR.

**5.20.16** Where non-standard or proprietary formats are used for storing the data in the VDR, the software for converting the stored data into open industry standard formats shall be provided on the portable storage device or resident in the VDR.

## **5.21 SIMPLIFIED VOYAGE DATA RECORDER (S-VDR)**

**5.21.1** The simplified voyage data recorder (S-VDR) shall continuously and automatically maintain sequential record of preselected data items obtained from the ship devices and systems, relating to the status and operational modes of the ship's equipment, command and control of the ship and environment. The recorded data shall be maintained for a period of at least 2 years following termination of recording.

**5.21.2** The method of recording shall ensure that the various data items can be co-related in date and time during playback on suitable equipment.

**5.21.3** The final recording medium shall be installed in a protective capsule, which may be fixed to the open deck of the ship or be of float-free type and shall meet the following requirements:

be capable to continue data recording during accident and of being accessed and of maintaining the recorded data;

be secure against tampering with data recorded;

be of a highly visible colour and marked with retro-reflective material;

be fitted with an appropriate device to aid location;

be marked with clearly seen inscription in English: "VOYAGE DATA RECORDER — DO NOT OPEN — REPORT TO AUTHORITIES".

**5.21.4** The special protective capsule designed to be fixed to open deck shall comply with all the requirements of 5.20.4.1 with the exception of the requirements for withstanding penetration (pin dropping). An acoustic underwater beacon ensuring location of the protective capsule shall operate in the frequency band of 25 to 30 Hz with battery life at least 30 days.

**5.21.5** The float-free type special protective capsule shall be fitted with means to facilitate grappling and recovery, after free ascent thereof, and meet the applicable requirements (as they relate to the mechanical and climatic effects) for the emergency position-indicating radio beacons defined in 9.1, Part IV "Radio Equipment". The device ensuring location of the float-free type protective capsule, after being automatically switched on, shall be capable of transmitting signal for at least:

48 h — an initial locating signal;

168 h — a locating homing signal.

**5.21.6** It shall be possible to record, as a minimum, the following data items:

date and time in steps ensuring a reconstruction of events sequence. Date and time referenced to UTC, may be obtained from a source external to the ship or from an internal clock with indication, which source is in use;

latitude and longitude of ship's position obtained from a receiver of radio navigation systems with indication of its type and operational mode, as well as the datum used;

ship's speed as indicated by the ship's log including an indication if it is through the water or over the ground;

ship's heading as indicated by the ship's gyrocompass or magnetic compass;

conversations, commands and sound signals on the bridge and also, if possible, announcements over intercom and public address system;

communications with other ships, objects and shore-based services using VHF radio equipment;

radar and auxiliary navigational data displayed on the radar display unit. The recording method shall ensure the possibility to playback an image as it was during recording regarding possible distortions connected with data compression during recording. If radar data is recorded, AIS information may be recorded additionally as a secondary source of information on both other and own ship;

if it is technically impossible to connect the radar installed on board ship to the simplified voyage data recorder, then the AIS target data shall be recorded as a source of information regarding both own and other ships.

**5.21.7** It may be possible to record other additional information derived from the items of ship's equipment listed in 5.20.6 and having appropriate outputs to provide the possibility of interfacing these items to S-VDR. In this case, recording of additional data shall not distort main data or affect their preservation.

**5.21.8** It shall not be possible to tamper with the selection of data being recorded nor the data, which has already been recorded. Any attempt of an unauthorised access to S-VDR operation shall be recorded.

**5.21.9** The recording method shall provide an actuation of alarm when a non-correctable error is detected during recording.

**5.21.10** S-VDR shall provide recording and storage of information of at least previous 12 h of a voyage.

**5.21.11** If the ship's source of electric power supply fails, the simplified voyage data recorder shall continue to record bridge audio for a period of 2 h using its own accumulator batteries. At the end of this 2 period, all recording shall cease automatically.

**5.21.12** Any interfacing to any data sensor shall be such that the operation of that sensor suffers no deterioration, even if the S-VDR system develops faults.

**5.21.13** The S-VDR shall provide an interface for downloading the stored data and playback the information to an external computer. The interface shall be compatible with an internationally recognized format, such as Ethernet, USB, Fire Wire or equivalent.

**5.21.14** A copy of the software programme providing the capability to download the stored data and playback the information onto a connected external laptop computer and for the playback of the data shall be provided for each S-VDR installation.

The software shall be compatible with an operating system available with commercial-off-the shelf laptop computers and provided on a portable storage device such as CD-ROM, DVD, USB-memory stick, etc.

**5.21.15** Instructions for executing the software and for connecting the external laptop computer to the S-VDR shall be provided.

**5.21.16** The portable storage device containing the software, the instructions and any special (not commercial-off-the-shelf) parts necessary for the physical connection of the external laptop computer, shall be stored within the main input of the S-VDR.

**5.21.17** Where non-standard or proprietary formats are used for storing the data in the VDR, the software for converting the stored data into open industry standard formats shall be provided on the portable storage device or resident in the S-VDR.



## **5.22 BRIDGE NAVIGATIONAL WATCH ALARM SYSTEM (BNWAS)**

**5.22.1** The BNWAS shall monitor the functioning of the main conning position and identify the watch officer unfitness, which may result in accident.

The system shall give visual and audible alarms to warn the watch officer and, if ignore, shall alert the ship's master or back-up officer.

**5.22.2** Provisions shall be made for three functioning modes of the watch officer fitness verification system:

**.1** automatic mode to ensure the automatic activation of the system when the heading or track control system is activated and the automatic deactivation of the system when the heading or track control system terminates.

In ships fitted with the BNWAS required in this Part, this system shall be in operation whenever the ship is underway at sea. Use of automatic mode in such ships is not allowed, and connection of the BNWAS to the heading or track control system is not required;

**.2** continuous mode of functioning;

**.3** total deactivation mode when, under any conditions, the system does not function.

**5.22.3** When activated, the BNWAS shall give visual and audible alarms in the following sequence:

**.1** immediately after the activation, the system shall remain dormant for a period 3 to 12 min set by the ship's master, where upon the visual alarm shall be actuated;

**.2** if the receipt of the visual alarm is not acknowledged by the watch officer within 15 s, the system shall initiate the first stage audible alarm on the bridge;

**.3** if the receipt of the first stage audible alarm is not acknowledged by the watch officer within 15 s since its actuating on the bridge, the second stage audible alarm shall additionally be activated in the back-up officer and/or ship's master accommodation;

**.4** if the second stage audible alarm is not acknowledged by the watch officer, back-up officer or ship's master within 90 s since its actuating, the third stage audible alarm shall be activated in all the spaces of officers' location;

**.5** in ships others than passenger ones, the second stage audible alarm may simultaneously be sounded in all the spaces where officers are located. In this case, the third stage audible alarm may be redundant;

**.6** in large ships the time interval between the second and third stage audible alarms may be increased up to 3 min necessary for the back-up officer and ship's master to get to the navigation bridge.

**5.22.4** The reset of the BNWAS to the initial state (acknowledgement of visual alarm receipt and deactivation of the audible alarm) shall be possible on the navigation bridge only, be carried out by one action of an operator, whereupon the countdown of the next dormant period shall start.

When the system is reset to the initial state before the termination of the dormant period, the system shall start the countdown of the next dormant period since that moment.

Reusable actions to reset the system to the initial state shall not prolong the duration of the dormant period or alter the sequence and time intervals between visual and audible alarms.

**5.22.5** The device for alarm (visual and audible) acknowledgement and system reset to the initial state shall be illuminated at night and may be integral with the BNWAS or designed as a separate block.

This device and its arrangement at the work station on the navigation bridge shall ensure its use by the watch officer only and prevent an unauthorized intervention of other people.

**5.22.6** The navigation bridge shall be provided with the means for prompt actuating the second and third stage audible alarm to urgently call the back-up officer and/or ship's master.

The function of such means shall be effected with a special button marked "Emergency Call".

**5.22.7** Under all operational conditions the BNWAS shall assure the time countdown with an accuracy of 5 % or 5 s, whichever is less.

**5.22.8** The BNWAS shall be provided with the following controls:

**.1** means for selection of a operational mode and duration of the dormant period protected against an unauthorized access;

**.2** means for prompt actuating the second and third stage audible alarm, if fitted;

.3 devices for alarm acknowledgement and system reset to the initial state, which shall be readily accessible and located on bridge wings, and all the workstations of the navigation bridge.

**5.22.9** The indication of the operational mode of the BNWAS for the watch officer shall be provided.

**5.22.10** The visual alarm activated on termination of the dormant period shall be flashing and visible from any workstation on the navigation bridge. The visual alarm colour shall not impair the conditions of environmental observations at night, and its brilliance shall be regulated. In this case, an opportunity to completely switch off the visual alarm shall be excluded.

**5.22.11** The first stage audible alarm activated on the navigation bridge in 15 s after visual alarm activation shall be of a distinctive tonality or modulation and be heard by the watch officer at all the workstations on the navigation bridge. The function of the first stage audible alarm may be engineered using one or more sounding devices.

Fitting the BNWAS, provision shall be made for selection of the tonality or modulation, as well as of the audible alarm volume. The follow-up alterations of these characteristics by the watch officer are not allowed.

**5.22.12** The second and third stage audible alarms activating sequentially if the first stage audible alarm was not acknowledged, shall be of distinctive sounding and loud enough to wake up a sleeper in spaces where the ship's master, back-up officer and officers are accommodated.

**5.22.13** All the blocks being part of the BNWAS shall be protected against unauthorized modifications in its operation introduced by the crew.

**5.22.14** Standard connectors for connecting visual and audible alarm activating devices, as well as additional devices for alarm acknowledgement and system reset to the initial state shall be used in the BNWAS.

**5.22.15** The BNWAS shall be powered from the ship's main power supply in compliance with the requirements of Part XI "Electrical Equipment" of the Rules for the Classification and Construction of Sea-Going Ships. The malfunction indication, and all elements of the Emergency Call facility, if incorporated, shall be powered from a battery maintained supply for a period of 6 h.

**5.23 LONG-RANGE IDENTIFICATION AND TRACKING (LRIT) SYSTEM EQUIPMENT**

**5.23.1** The equipment of a Long-Range Identification and Tracking System (LRIT system) shall provide automatic transmission of the following LRIT information:

- .1 the identity of the ship;
- .2 the position of the ship (latitude and longitude);
- .3 the date and time of the position provided.

**5.23.2** The LRIT system equipment shall conform to the performance standards and functional requirements of this Chapter and applicable standards 5.1 and 5.2 of Part IV "Radio Equipment".

**5.23.3** The LRIT system equipment shall comply with the following minimum requirements:

.1 be capable of automatically and without human intervention on board the ship transmitting the ship's LRIT information at 6-hour intervals to an LRIT Data Centre;

.2 be capable of being configured remotely to transmit LRIT information at variable intervals;

.3 be capable of transmitting LRIT information following receipt of polling commands;

.4 interface directly to the shipborne global navigation satellite system equipment, or have internal positioning capability;

.5 be supplied with energy from the main and emergency source of electrical power.

This provision shall not apply to ships using for the transmission of LRIT information any of the radio communication equipment provided for compliance with the provisions of Part IV "Radio Equipment". In such cases, the shipborne equipment shall be provided with sources of energy as specified in 2.3, of the mentioned Part;

.6 be tested for resistance to mechanic and climatic effects as well as for electromagnetic compatibility with other electronic and electric shipborne equipment.

**5.23.4** The LRIT equipment shall provide the functionality specified in Table 5.23.4.

Table 5.23.4

Parameter	Comments
Shipborne equipment identifier	The identifier used by the shipborne equipment
Positional data	The GNSS position (latitude and longitude) of the ship (based on the WGS-84 datum). Position: the equipment shall be capable of transmitting the GNSS position (latitude and longitude) of the ship (based on WGS-84 datum) without human interaction on board the ship. On-demand position reports <sup>1</sup> : the equipment shall be capable of responding to a request to transmit LRIT information on demand without human interaction on board the ship, irrespective of where the ship is located. Pre-scheduled position reports <sup>2</sup> : the equipment shall be capable of being remotely configured to transmit LRIT information at intervals ranging from a minimum of 15 min to periods of 6 h to the LRIT Data Centre, irrespective of where the ship is located and without human interaction on board the ship
Time stamp 1	The date and time <sup>3</sup> associated with the GNSS position The equipment shall be capable of transmitting the time <sup>3</sup> associated with the GNSS position with each transmission of LRIT information
<sup>1</sup> On-demand position reports — means transmission of LRIT information as a result of either receipt of polling command or of remote configuration of the equipment so as to transmit at interval other than the preset ones. <sup>2</sup> Pre-scheduled position reports — means transmission of LRIT information at the preset transmit intervals. <sup>3</sup> All times shall be indicated as Universal Co-ordinated Time (UTC).	

**5.23.5** The shipborne equipment shall transmit the LRIT information using a communication system which provides coverage in all areas where the ship operates.

**5.23.6** The shipborne equipment shall be set to automatically transmit the ship's LRIT information at 6-hour intervals to the LRIT Data Centre identified by the Flag State Administration, unless the LRIT Data User requesting the provision of LRIT information specifies a more frequent transmission interval.

**5.23.7** The LRIT equipment design shall provide for the possibility of working ability periodic check without the LRIT information transmission.

**5.23.8** It shall be possible to switch off the LRIT equipment or to stop the transmission of the LRIT information (with the corresponding record in the ship's Log Book) in the following cases:

**.1** if, according to the international agreements, rules and standards, the navigational information is to be protected; or

**.2** in exceptional circumstances, and, as far as possible, for a short period of time, if the captain of the ship thinks that the LRIT equipment operation threatens the ship's safety or security level.

**5.23.9** Where a ship is undergoing repairs, modifications or conversions in dry-dock or in port or is laid up for a long period, the master or the Flag State Administration may reduce the frequency of the transmission of LRIT information to one transmission every 24-hour period, or may temporarily stop the transmission of such information with the relevant note in the log book. The LRIT equipment shall be capable of ensuring such reduction of the LRIT information transmission frequency and temporary stop of its transmission.

## 5.24 WEATHER STATION

**5.24.1** The ship weather station, depending on the ship's purpose and sensors availability, shall provide continuous monitoring of the following parameters:

**.1** atmospheric pressure within the range from 0,9 to 1,1 bar (675 — 825 millimeters of mercury) with an error limit of 0,5 millimeter of mercury;

**.2** air temperature within the range from  $-40\text{ }^{\circ}\text{C}$  to  $+60\text{ }^{\circ}\text{C}$  with an error limit of  $0,5\text{ }^{\circ}\text{C}$ ;

**.3** relative air humidity with an error limit of  $\pm 3\%$  (measurement shall be made at an ambient air temperature from  $-20\text{ }^{\circ}\text{C}$  to  $+50\text{ }^{\circ}\text{C}$ );

**.4** apparent and true wind directions within the range of course angles from  $0$  to  $360^{\circ}$  with an error limit of  $5^{\circ}$  (with the apparent wind speed  $5\text{ m/s}$  and more);

**.5** apparent and true wind speeds within the range from  $1\text{ m/s}$  to  $50\text{ m/s}$  with an error limit of  $\pm 3\%$  of the current wind speed;

**.6** velocity and direction of currents:

velocity range:  $0 - 300\text{ cm/s}$ ;

horizontal accuracy  $- 1\text{ cm/s}$ ;

vertical accuracy  $- 2,0\text{ cm/s}$ ;

direction range:  $0 - 360^{\circ}$ ;

accuracy:  $\pm 8^{\circ}$ .

**.7** water temperature:

range of water temperature measurements depending on an area of navigation:

from  $-3\text{ }^{\circ}\text{C}$  to  $+37\text{ }^{\circ}\text{C}$ ;

accuracy:  $\pm 0,1\text{ }^{\circ}\text{C}$ ;

**.8** sea state recorded parameters: (maximum wave height, average period, wave steepness);

If the ship is fitted with a helideck, the following sensors shall be added to the weather station:

sensor of meteorological visibility range providing the visibility range measurements within the range from  $10$  to  $7500\text{ m}$  and with an accuracy not more than  $20\%$  of the measured value;

sensor of the cloud base providing measurement of the height to the cloud base within the range from  $10$  to  $8000\text{ m}$ , with a resolution up to  $10\text{ m}$  and accuracy not less than  $\pm 20\text{ m}$ .

**5.24.2** It shall be possible to interface the ship weather station with the heading control system and log in accordance with the International Standard on Interface of Marine Radio and Navigational Equipment, and within the range from  $0$  to  $50$  knots the weather station shall provide the calculation and display of true wind speed and direction on the basis of the information supplied from the heading control system and log.

**5.24.3** The readings of the weather station indicator(s) shall be distinct and clearly visible under any lighting conditions at the place of installation.

**5.24.4** The weather station shall provide the possibility of sending all measured parameters to other devices for their processing and recording. Data transfer formats shall comply with the International Standard on Interface of Marine Radio and Navigational Equipment.

**5.24.5** The weather station shall provide measurement of parameters and their transfer to other devices at a frequency of not less than  $0,5\text{ Hz}$ .

**5.24.6** Current values of the measured parameters shall be displayed in digital format with refresh interval not exceeding  $15\text{ s}$ .

**5.24.7** The weather station display shall provide the possibility of graphical representation of the measured parameters, at that the measured values obtained for the last  $24\text{ h}$  shall be displayed.

**5.24.8** The weather station shall provide measurement and display of the measured parameters in digital format in  $15$  minutes after switching on.

**5.24.9** In case of malfunction of one or two sensors, the weather station shall remain operative with the failure-free sensors.

**5.24.10** The weather station sensors shall be calibrated in compliance with the procedures stipulated in the manufacturer's documentation, and the intervals between calibrations shall not exceed two years.

## **5.25 ANALOG-DIGITAL SIGNAL CONVERTER**

**5.25.1** The analog-digital signal converter shall provide:

acquisition of navigational information on the ship's course and/or speed and/or depth under a keel received from the equipment not fitted with a standard digital interface;

conversion of signals from analog gyrocompass and log repeaters into digital form corresponding to a certain standard format;

generation of standard messages HDT, THS, HDG, VHW, VTG, VBW, ROT, DPT, DBT in accordance with the International Standard on Interface of Marine Radio and Navigational Equipment and their transfer at a speed not less than 4800 bit/s (data transfer rate may be changed by the hardware depending on the normal operation of the information user) with intervals not exceeding 1 s via RS232, RS422 or CAN interfaces (with power supply support).

The analog-digital signal converter shall be provided with a function of calculating the checksum of output statement, which shall be set during installation of the converter taking into account the particulars of the equipment connected.

**5.25.2** The analog-digital signal converter shall be interfaced with the following devices:

gyrocompass having selsyn (sine voltage of selsyn windings) or step (successions of voltage impulses) outputs and/or

log having pulse outputs and also open contact outputs and/or

echo-sounder having analog output.

**5.25.3** The analog-digital converter shall provide a galvanic or optical isolation with the windings of the rate-of-turn indicators, an optically coupled isolation with the network of rate-of-turn indicators, log, echo sounder and optically coupled isolation with the navigational equipment outputs.

**5.25.4** The analog-digital converter shall automatically determine availability and accessibility of information from the connected navigational information sensors (equipment and systems).

In the absence of automatic synchronization, the converter shall provide for a possibility of synchronization and subsequent check of correspondence of the analog source readings to the converter output data (input and check of the initial values).

**5.25.5** Design and structure of the analog-digital converter shall provide for the visual alarm, which is activated when the information received from the connected equipment is missing or unavailable.

When the visual alarm is activated, data transfer to the connected users shall be terminated until the normal operation of the converter is restored.

**5.25.6** The analog-digital converter shall be supplied from the same source(s) of electrical power, which provide(s) power supply to the equipment providing input information for the converter, at that the analog-digital converter shall have visual indication of electrical power supply.

## **5.26 DIGITAL SIGNAL MULTIPLICATOR**

**5.26.1** The digital signal multiplier shall provide:

receipt, multiplication to the output channels and transfer (without distortion) of digital signals to users;  
optically coupled isolation of the navigational equipment outputs and inputs of digital signal users;  
automatic operation immediately after power-up;  
possibility of changing data exchange interfaces: RS232, RS422, RS485.

**5.26.2** When the receiving part of the information user requires, the multiplier may provide the possibility to change digital signal transfer rate, at that the signal distortion shall be excluded.

**5.26.3** The digital signal multiplier is recommended to provide visual indication of input and output data.

**5.26.4** The digital signal multiplier shall be supplied from the same source(s) of electrical power, which provide(s) power supply to the equipment providing input information for the multiplier, at that the digital signal multiplier shall have visual indication of electrical power supply.

## **5.27 ELECTRONIC INCLINOMETER**

**5.27.1** The electronic inclinometer shall:

- .1** determine the actual heel angle, roll amplitude and roll period;
- .2** present the information on a bridge display;
- .3** provide a standardized interface to instantaneous heel angle to VDR.

**5.27.2** Electronic inclinometers shall be capable of measuring the actual heel angle and determining the amplitude of the rolling oscillation of the ship over a range of  $\pm 90^\circ$ .

**5.27.3** Electronic inclinometers shall be capable of measuring the time between the maximum values of the rolling oscillation and determining the roll period over a minimum range of 4 to 40 s.

**5.27.4** Minimum accuracy of the measurements shall be 5 % of reading or  $\pm 1^\circ$ , whichever is the greater for angle measurements and 5 % of reading or  $\pm 1$  s, whichever is the greater for time measurements.

Actual heel angle and time measurement accuracy shall not be unduly affected by other linear or rotational movements of the ship (e.g. surging, swaying, heaving, pitching, yawing) or by transverse acceleration ranging from  $-0,8g$  to  $+0,8g$ .

**5.27.5** The actual heel angle to port or starboard shall be indicated in an analogue form between the limits of  $\pm 45^\circ$ .

**5.27.6** Electronic inclinometers shall display the roll period with a minimum resolution of 1 s and the roll amplitude to both port and starboard side with a minimum resolution of  $1^\circ$ .

The display may be implemented as a dedicated display or integrated into other bridge systems.

**5.27.7** Electronic inclinometers may optionally provide a warning for indicating that a set heel angle had been exceeded.

**5.27.8** Electronic inclinometers shall internally check and indicate to the user if all components are operative and if the information provided is valid or not.

**5.27.9** Electronic inclinometers shall comprise a digital interface providing actual heel angle information to other systems like, e.g. VDR, with an update rate of at least 5 Hz. Electronic inclinometers shall also comprise a digital interface providing the displayed information of roll period and roll amplitude (refer to 5.27.6).

Electronic inclinometers shall have a bidirectional interface to facilitate communication, to transfer alerts from inclinometers to external systems and to acknowledge and silence alerts from external systems.

The digital interface shall comply with the relevant international standards.

**5.27.10** The installation position of the sensors of the electronic inclinometer shall be recorded and made available for the configuration of the VDR.



## **5.28 RADAR ICE DISPLAY**

**5.28.1** Radar Ice Display shall provide receiving, processing and displaying radar signals in order to obtain information about ice conditions.

**5.28.2** Requirements for displaying:

**.1** the equipment shall display the ice conditions based on radar data in luminance gradations of the same color or in a color palette;

**.2** it shall be possible to adjust the brightness and contrast of the radar image of the ice condition;

**.3** the image of the ice condition shall allow to evaluate the types of ice, its parameters and characteristics, such as the following:

ice concentration;

forms of ice and size floes;

dynamic processes;

open water areas;

hummocking;

large ice formations (icebergs);

ice edge;

**.4** it shall be possible to measure the coordinates and dimensions of selected objects of ice conditions;

**.5** the radar image of the ice condition shall have a resolution no worse than the radar's resolution in direction and range;

**.6** it shall be possible to select the orientation of the radar image relative to the true meridian (North Up) or to the heading (Course Up);

**.7** it shall be possible to change the scale of the radar image of the ice conditions;

**.8** the maximum range of the display of the conditions shall be not less than 8 miles;

**.9** it shall be possible to indicate the position of the ship and the heading line against the background of the radar image;

**.10** it shall be possible to suppress the image of the heading line;

**.11** if a radar image and an electronic map are simultaneously displayed in the indicator, their images shall use the constant common reference point of their own ship and coincide in scale, projection and orientation;

**.12** it shall be possible to further process radar signals in order to distinguish small objects and increase the signal-to-interference ratio in the image to be displayed. Processing parameters shall be adjustable;

**.13** it shall be possible to suppress interference from extended meteorological formation (rain);

**.14** there shall be an alarm for the absence of signals from the radar and navigation sensors;

**.15** there shall be no radar image of the ice conditions in the absence of signals from the radar.

**5.28.3** Connection requirements:

**.1** connection to the radar shall be carried out via digital standard interfaces or in using analog radar video signal and synchronization signals (separate or mixed). The manufacturer shall describe the connection interface and the characteristics of the radar to which connection is possible;

**.2** the equipment shall not interfere with the radar's operability and the integrity of its design;

**.3** the equipment shall automatically consider changes in radar operation modes;

**.4** it shall be possible to connect to the navigation sensors of ship's position, course and speed;

**.5** it shall be possible to adjust the radar image by angle and distance.

## **6 PERFORMANCE STANDARDS FOR THE PRESENTATION OF NAVIGATION-RELATED INFORMATION ON SHIPBORNE NAVIGATION DISPLAYS**

**6.1** These Performance Standards specify the presentation of navigational information on the bridge of a ship, including the consistent use of navigational terms, abbreviations, colours and symbols, as well as other presentation characteristics.

These performance standards shall be applied in addition to the requirements for presentation of navigational information by other navigational equipment and systems, the performance standards of which are covered by this Part of the Rules.

Any additional means of information display, not specified by this Part of the Rules, shall present the navigational information in accordance with these performance standards.

**6.2** The presentation of information shall be consistent with respect to screen layout and arrangement of information.

Data and control functions shall be logically grouped.

Priority of information shall be identified for each application, permanently displayed and presented to the user in a prominent manner by, for example, use of position, size and colour.

**6.3** The presentation of information shall be consistent with respect to values, units, meaning, sources, validity, and if available, integrity.

**6.4** The presentation of information shall be clearly separated into an operational display area (e. g. radar, chart) and one or more user dialogue areas (e. g. menus, data, control functions).

**6.5** The presentation of alphanumeric data, text, symbols and other graphical information (e.g. radar image) shall support readability from typical user positions under all ambient light conditions likely to be experienced on the bridge of a ship, and with due consideration to the night vision of the officer of the watch.

Alphanumeric data and text shall be presented using a clearly legible non-italic, sans-serif font. The font size shall be appropriate for the viewing distance from user positions likely to be experienced on the bridge of a ship. Text shall be presented using simple unambiguous language that is easy to understand.

Navigation terms and abbreviations shall be presented using the nomenclature defined in Table 5.7.58-1.

**6.6** When icons are used, their purpose shall be intuitively recognized by appearance, placement and grouping.

**6.7** The colours used for the presentation of alphanumeric data, text, symbols and other graphical information shall provide sufficient contrast against the background under all lighting conditions likely to be experienced on the bridge of a ship.

The colours and brightness shall take into account the light conditions of daylight, dusk and night.

The presentation shall support night viewing by showing light foreground information on a dark non-reflecting background at night.

The background colour and contrast shall be chosen to allow presented information to be easily discriminated without degrading the colour coding aspects of the presentation.

**6.8** Symbols used for the presentation of operational information are defined in Table 5.7.58-3.

Symbols used for the display of charted information shall comply with relevant IHO standards.

**6.9** When colour coding is used for discrimination of conspicuousness of alphanumeric text, symbols and other information, all colours in the set shall clearly differ from one another.

**6.10** When colour coding is used, the red colour shall be used for coding of alarm related information.

**6.11** When colour coding is used, it shall be used in combination with other symbol attributes, such as size, shape, and orientation.

**6.12** Flashing of information shall be reserved for unacknowledged alarms.

**6.13** The source, validity, and, where possible, the integrity of information shall be indicated.

Invalid information or information with low integrity shall be clearly marked, qualitatively and/or quantitatively. Invalid information or information with low integrity may be quantitatively indicated by displaying absolute or percentage values.

**6.14** When colour coding is used, information with low integrity shall be qualitatively marked by using yellow, and invalid information shall be qualitatively marked by using red.

**6.15** In order to show that the screen is being refreshed, means shall be provided to immediately make the user aware of a presentation failure on an operational display (e.g. "picture freeze").

**6.16** The operational status of information shall be indicated as shown in Table 6.16.

Table 6.16

Status	Visual indication	Audible signal
Alarm, not acknowledged	Red, flashing	Accompanied by an audible signal
Alarm, acknowledged Invalid information	Red	Suppression of audible signal
Important indications/warnings (e. g. low integrity)	Yellow	Silence unless otherwise specified by the Organization
Normal state	None required, optionally green	Silence

**6.17** A list of alarms shall be provided based on the sequence of occurrence. Additional indication of priority, as set by the user, shall be provided on displays showing alarms from multiple sources.

Alarms that have been acknowledged and are no longer relevant shall be deleted from the list of alarms, but may be retained in an alarm history list.

**6.18** When a single display is used to present information from multiple navigation systems and equipment, the presentation of alarms and indications shall be consistent for the display of the time of alarm occurrence, the cause of the alarm, the source of the alarm and the status of the alarm (e.g. acknowledged, not acknowledged).

**6.19** If displays are capable of presenting information in different mode(s), there shall be a clear indication of the mode in use, for example, orientation, stabilization, motion, and chart projection.

**6.20** When a graphical representation of own ship is provided, it shall be possible for the user to select either a scaled ship's outline or a simplified symbol as specified in Table 5.7.58-3.

The size of the ship's outline or the simplified symbol in the graphical presentation shall be the true scale size of the ship or 6 mm, whichever is greater.

**6.21** A heading line and, where appropriate, a velocity vector shall be associated with own ship symbol and shall originate at the position of the consistent common reference point (CCRP).

**6.22** The presentation of charted information shall comply with the relevant IHO standards.

**6.23** The presentation of proprietary charted information shall comply with relevant IHO standards, as far as practical. There shall be a clear indication when the presentation is not in accordance with IHO standards.

**6.24** The presentation of user-added information shall comply with the relevant IHO standards, as far as practical.

**6.25** If chart data derived from different scales appear on the display, the scale boundary shall be clearly indicated.

**6.26** Radar images shall be displayed by using a basic colour that provides optimum contrast. Radar echoes shall be clearly visible when presented on top of a chart background.

The relative strength of echoes may be differentiated by tones of the same basic colour.

The basic colour may be different for operation under different ambient light conditions.

**6.27** Target trials shall be distinguishable from targets and clearly visible under all ambient light conditions.

**6.28** Target information may be provided by radar tracking and/ or by reported target information from the Automatic Identification System (AIS).

**6.29** The operation of the radar target tracking and the processing of reported AIS information, including the number of targets presented, related to screen size, shall be in compliance with standards as defined in 5.7.

The presentation of radar target tracking and AIS information is defined within these performance standards.

**6.30** As far as practicable, the user interface and data format for operating, displaying and indicating radar tracking and AIS information shall be consistent.

**6.31** There shall be an indication when the target tracking and/or reported target processing/display capacity is about to be exceeded.

**6.32** There shall be an indication when the target tracking and/or reported target processing/display capacity has been exceeded.

**6.33** To ensure that the clarity of the total presentation is not substantially impaired, it shall be possible to filter the presentation of sleeping AIS targets (e.g. by target range, CPA/TCPA or AIS target class A/B, etc.).

Sleeping AIS targets shall be automatically activated when meeting user defined parameters (e.g. target range, CPA/TCPA or AIS target class A/B).

**6.34** If a filter is applied, there shall be a clear and permanent indication.

The filter criteria in use shall be readily available.

**6.35** It shall not be possible to remove individual AIS targets from the display.

**6.36** If zones for the automatic activation of AIS targets are provided, they shall be the same as for automatic radar target acquisition, if available.

Any user defined zones (e.g. acquisition/activation zones) in use shall be presented in graphical form.

**6.37** Targets shall be presented with symbols according to Table 5.7.58-3.

**6.38** AIS information shall be graphically presented either as sleeping or activated targets.

**6.39** The course and speed of a tracked radar target or reported AIS target shall be indicated by a vector that clearly shows the predicted motion. The vector time (length) shall be consistent for presentation of any target regardless of its source.

**6.40** The presentation of vector symbols shall be consistent irrespective of the source of information.

The presentation mode shall be clearly and permanently indicated, including for example: True/Relative vector, vector time and vector stabilisation.

**6.41** The orientation of the AIS target symbol shall indicate its heading.

If the heading information is not received, the orientation of the AIS symbol shall be aligned to the COG.

When available, the turn or rate of turn (ROT) indicator and/ or the path prediction shall indicate the manoeuvre of an activated AIS target.

**6.42** A consistent common reference point shall be used for the alignment of tracked target symbols and AIS target symbols with other information on the same display.

**6.43** On large scale/low range displays, a means to present a true scale outline of an activated AIS target shall be provided.

**6.44** It shall be possible to display the past positions of activated targets.

**6.45** A target selected for the display of its alphanumeric information shall be identified by the relevant symbol.

If more than one target is selected for data display, the symbols and the corresponding data shall be clearly identified.

**6.46** There shall be a clear indication to show that the target data is derived from radar or AIS or from a combination of these.

**6.47** For each selected tracked radar target the following data shall be presented in alphanumeric form: source(s) of data, measured range of target, measured bearing of target, predicted target range at the closest point of approach (CPA), predicted time to CPA (TCPA), true course of target, true speed of target. Additional target information shall be provided on request.

**6.48** For each selected AIS target the following data shall be presented in alphanumeric form: source of data, ship's identification, position and its quality, calculated range of target, calculated bearing of target, CPA, TCPA, COG, SOG, navigational status. Additional target information shall be provided on request.

**6.49** If the received AIS information is incomplete, the absent information shall be clearly indicated in the target data field as missing.

**6.50** The data shall be displayed and continually updated, until another target is selected for data display or until the window is closed.

**6.51** Means shall be provided to present own ship AIS data on request.

**6.52** The alphanumeric displayed data shall not obscure graphically presented operational information.

**6.53** A clear indication of the status of the alarms and of the alarm criteria shall be given.

**6.54** A CPA/TCPA alarm of a tracked radar or activated AIS target shall be clearly indicated and the target shall be clearly indicated and the target shall be clearly marked by a dangerous target symbol.

**6.55** If a user defined acquisition/ activation zone facility is provided, a target entering the zone shall be clearly identified with the relevant symbol and for tracked radar targets an alarm shall be given. The zone shall be identified with the relevant symbology, and shall be applicable to tracked radar and AIS targets.

**6.56** The last position of a lost target shall be clearly marked by a lost target symbol on the display, and the lost target alarm shall be given.

The lost target symbol shall disappear if the signal is received again, or after the alarm has been acknowledged.

There shall be a clear indication whether the lost target alarm function for AIS targets is enabled or disabled.

**6.57** An automatic target association function serves to avoid the presentation of two target symbols for the same physical target.

If target data from AIS and radar tracking are both available and if the AIS and radar information are considered as one target, then as a default condition, the activated AIS target symbol and the alphanumeric AIS target data shall be automatically selected and displayed.

The user shall have the option to change the default condition to the display of tracked radar targets and shall be permitted to select either radar tracking or AIS alphanumeric data.

**6.58** If the AIS and radar information are considered as two distinct targets, one activated AIS target and one tracked radar target shall be displayed. No alarm shall be raised.

**6.59** The AIS presentation status shall be indicated according to Table 6.59.

Table 6.59

Function	Cases to be presented		Presentation
AIS ON/OFF	AIS processing switched ON/ graphical presentation switched OFF	AIS processing switched ON/ graphical presentation switched ON	Alphanumeric or graphical
Filtering of sleeping AIS targets (6.33 — 6.35)	Filter status	Filter status	Alphanumeric or graphical
Activation of targets (6.33, 6.36)		Activation criteria	Graphical
CPA/TCPA (6.53 — 6.56)	Function ON/OFF CPA/ TCPA Criteria Sleeping targets included	Function ON/OFF CPA/TCPA Criteria Sleeping targets included	Alphanumeric and graphical
Lost target alarm (6.56)	Function ON/OFF Lost target filter criteria	Function ON/OFF Lost target filter criteria	Alphanumeric and graphical
Target association (6.57 — 6.58)	Function ON/OFF Association criteria Default target priority	Function ON/OFF Association criteria Default target priority	Alphanumeric

**6.60** A trial manoeuvre simulation shall be clearly identified by the relevant symbol positioned astern of own ship within the operational display area of the screen.

**6.61** If the display equipment is capable of supporting the presentation of multiple functions then there shall be a clear indication of the primary function supported by the presentation (e.g. Radar, ECDIS).

It shall be possible to select the Radar presentation or the ECDIS presentation by a simple operator action.

**6.62** If a radar image and an electronic chart are displayed together, the chart and the radar image shall use a consistent common reference point and match in scale, projection and orientation. Any offset shall be indicated.

**6.63** Range scales of 0,25; 0,5; 0,75; 1,5; 3; 6; 12 and 24 miles shall be provided. Additional range scales are permitted. These range scales do not apply when presenting raster chart data.

The range scale shall be permanently indicated.

**6.64** When range rings are displayed, the range ring scale shall be indicated.

**6.65** No part of the operational display area shall be permanently used for presentation of information that is not part of the navigation presentation (e.g. pop up displays, drop down menus and information windows).

Temporary, limited and relevant alphanumeric data may be displayed adjacent to a selected symbol, graphic or target within the operational display area.

**6.66 RADAR display.**

**6.66.1** Radar video, tracked radar targets and AIS targets shall not be substantially degraded, masked or obscured by other presented information.

**6.66.2** It shall be possible to temporarily suppress all graphical information from the display, retaining only radar video and trails.

**6.66.3** The brightness of radar echoes and associated graphic symbols for tracked radar targets shall be variable. It shall be possible to control the brightness of all displayed information. There shall be independent means to adjust the brightness of groups of displayed graphics and alphanumeric data. The brilliance of the heading line shall not be variable to extinction.

**6.66.4** Vector chart information may be displayed on a radar presentation. This shall be accomplished using layers selected from the chart database. As a minimum, the elements of the ECDIS standard display shall be available for individual selection by category or layer, but not as individual objects. As far as practical, chart information shall be presented in accordance with the ECDIS performance standards and with these presentation standards.

**6.66.5** If chart information is displayed within the operational display area, the display of radar information shall have priority. The chart information shall be clearly perceptible as such. The chart information shall not substantially degrade, mask or obscure the radar video, tracked radar targets and AIS targets.

**6.66.6** When chart information is displayed, there shall be permanent indication of its status. Source and update information shall also be made available.

**6.66.7** Map graphics may be displayed, but not substantially degrade, mask or obscure the radar video, tracked radar targets and AIS targets.

**6.67 ECDIS display.**

**6.67.1** The ENC and all updates to it shall be displayed without any degradation of their information content.

**6.67.2** Chart information shall not be substantially degraded, masked or obscured by other presented information.

**6.67.3** It shall be possible to temporarily suppress all supplemental information from the display, retaining only chart related information contained in the display base.

**6.67.4** It shall be possible to add or remove information from the ECDIS display. It shall not be possible to remove information contained in the Display Base from the ECDIS display.

**6.67.5** It shall be possible to select a safety contour from the depth contours provided by the ENC. The safety contour shall be emphasized over other contours on the display.

**6.67.6** It shall be possible to select a safety depth. Soundings equal to or less than the safety depth shall be emphasized whenever spot soundings are selected for display.

**6.67.7** An indication shall be provided if the information is displayed at a larger scale than that contained in the ENC, or if own ship's position is covered by an ENC at a larger scale than that provided by the display.

**6.67.8** Overscaled areas shown on the ECDIS display shall be identified.

**6.67.9** Radar and target information may be displayed on ECDIS but shall not substantially degrade, mask or obscure the chart information. As far as practical, radar and target information shall be presented in accordance with the radar performance standard and with these presentation standards.

**6.67.10** Radar and target information shall be clearly distinguishable from the chart information. It shall be possible to remove this information by a simple operator action.

**6.67.11** Information from additional sources may be displayed on ECDIS but shall not substantially degrade, mask or obscure the chart information.

**6.67.12** Additional information shall be clearly distinguishable from the chart information. It shall be possible to remove this information by a simple operator action.

**6.68** The user may configure a presentation for a specific task at hand. The presentation may include radar and/ or chart information, in combination with other navigation or ship related data. When not fully compliant with the Radar or ECDIS performance standards, such a presentation shall be identified as an auxiliary presentation.

**6.69** As far as practical, the presentation of any radar and/or ECDIS related functions shall be compliant with the requirements of the relevant performance standards and of these presentation standards, with the exception of size requirements for the operational area. Chartlets or windows or radar information may be presented along with other information associated with the task at hand.

**6.70** It shall be possible to adjust the contrast and brightness of the display provided, as applicable to the display technology. It shall not be possible to dim the display. The range of control shall permit the display to be legible under all ambient light conditions.

**6.71** It shall be possible for the navigator to reset the values of contrast and/ or brightness to a preset or default condition.

**6.72** Where magnetic fields degrade the presentation of navigation information, a means to neutralise the effect of magnetic fields shall be provided.

**6.73** Display equipment shall be of sufficient size to support the requirements of the relevant performance standards specified in this Part.

**6.74** The operational display area of the chart presentation for route monitoring shall be at least 270 × 270 mm.

**6.75** The operational display area of the radar presentation shall be at least a circle of diameter of:  
180 mm — for ships smaller than 500 gross tonnage;  
250 mm — for ships larger than 500 gross tonnage and High-Speed Craft (HSC) less than 10000 gross tonnage;

320 mm — for ships larger than 10000 gross tonnage.

**6.76** Multicoloured display equipment shall be used except where monochrome displays are permitted within individual performance standards specified in this Part of the Rules.

**6.77** Multicoloured operational displays including multifunction displays (e.g. conning displays) shall provide a minimum of 64 colours except where permitted or not required, or when used for a single specific purpose (e. g. speed log, echo sounder).

**6.78** Operational display equipment including multifunction displays (e.g. conning displays) shall provide a minimum screen resolution of 1280 × 1024 or equivalent for a different aspect ratio, except where permitted or not required, or when used for a single specific purpose (e. g. speed log, echo sounder).

**6.79** The display shall support the reading of information under all ambient conditions, simultaneously, by at least two users, from standing and sitting operator positions likely to be found on the bridge of a ship.

**6.80** Technical specifications, operational and maintenance instructions of the means of presentation of navigational information shall be constantly available on each ship in English (Russian) language. This information shall contain the list of all relevant terms, abbreviations, symbols and definitions.

**RECOMMENDATIONS ON BRIDGE DESIGN, EQUIPMENT ARRANGEMENT  
AND PROCEDURES (BDEAP)**

The present Appendix is applied to ships contracted for construction on or after 1 January, 2006.

**Contents**

**Foreword**

**1 General**

1.1 Scope and approach

1.2 Structure and application

1.3 Normative references

1.4 Informative references

1.5 Definitions

1.6 Volume of documentation to be submitted by the shipbuilder for approval

1.7 Volume of documentation to be submitted by the shipbuilder for information

1.8 Volume of documentation to be submitted by the shipowners for approval

1.9 Volume of documentation to be submitted by the shipowners for information

1.10 On board tests

**2 Bridge design**

2.1 Functions, tasks and means

2.2 Types and range of workstations

2.3 Working environment

2.4 Bridge passageways

2.5 Workstations arrangements and required fields of vision

2.6 Fields of vision and bridge window arrangement

2.7 Workstations layout, consoles and chair arrangement

**3 Design and arrangement of navigational systems and equipment**

3.1 Design and quality of navigational systems and equipment

3.2 Bridge alarm management

3.3 Arrangement of navigational systems and equipment

**4 Bridge procedures**

4.1 Bridge team management

4.2 Other bridge procedures

**Annex 1.** Analysis and details of bridge design principles and equipment arrangement

**Annex 2.** Examples of arrangement of bridge main equipment

Table of tasks and related means for safe operations

Separate workstations

Standby workstations.



## **RECOMMENDATIONS ON BRIDGE DESIGN, EQUIPMENT ARRANGEMENT AND PROCEDURES (BDEAP)**

### **INTRODUCTION**

The present Recommendations on Bridge Design, Equipment Arrangement and Procedures (BDEAP) set forth a set of requirements for compliance with the principles and aims of the International Convention for the Safety of Life at Sea (SOLAS-74) and other international documents relating to the bridge design.

The requirements include guidance notes that are recommendations on how the requirements may be met by acceptable technical solutions, which shall be considered examples only and do not in any way exclude alternative solutions that may fulfill the purpose of the requirements.

The requirements, which affect bridge design, design and arrangement of navigational equipment and systems on the bridge and bridge procedures shall be taken with the aim of:

**.1** facilitating the tasks to be performed by the bridge team and the pilot in making full appraisal of the situation and in navigating the ship safely under all operational conditions;

**.2** promoting effective and safe bridge resource management;

**.3** enabling the bridge team and the pilot to have convenient and continuous access to essential information, which is presented in a clear and unambiguous manner, using standardized symbols and coding systems for controls and displays;

**.4** indicating the operational status of automated functions and integrated components, systems and/or sub-systems;

**.5** allowing for expeditious, continuous and effective information processing and decision-making by the bridge team and the pilot;

**.6** preventing or minimizing excessive or unnecessary work and any condition or distraction on the bridge, which may cause fatigue or interfere with the vigilance of the bridge team and the pilot;

**.7** minimizing the risk of human error and detecting such error, if it occurs, through monitoring and alarm systems, in time for the bridge team and the pilot to take appropriate action.

Overview of design principles of the present requirements is given in Figure.

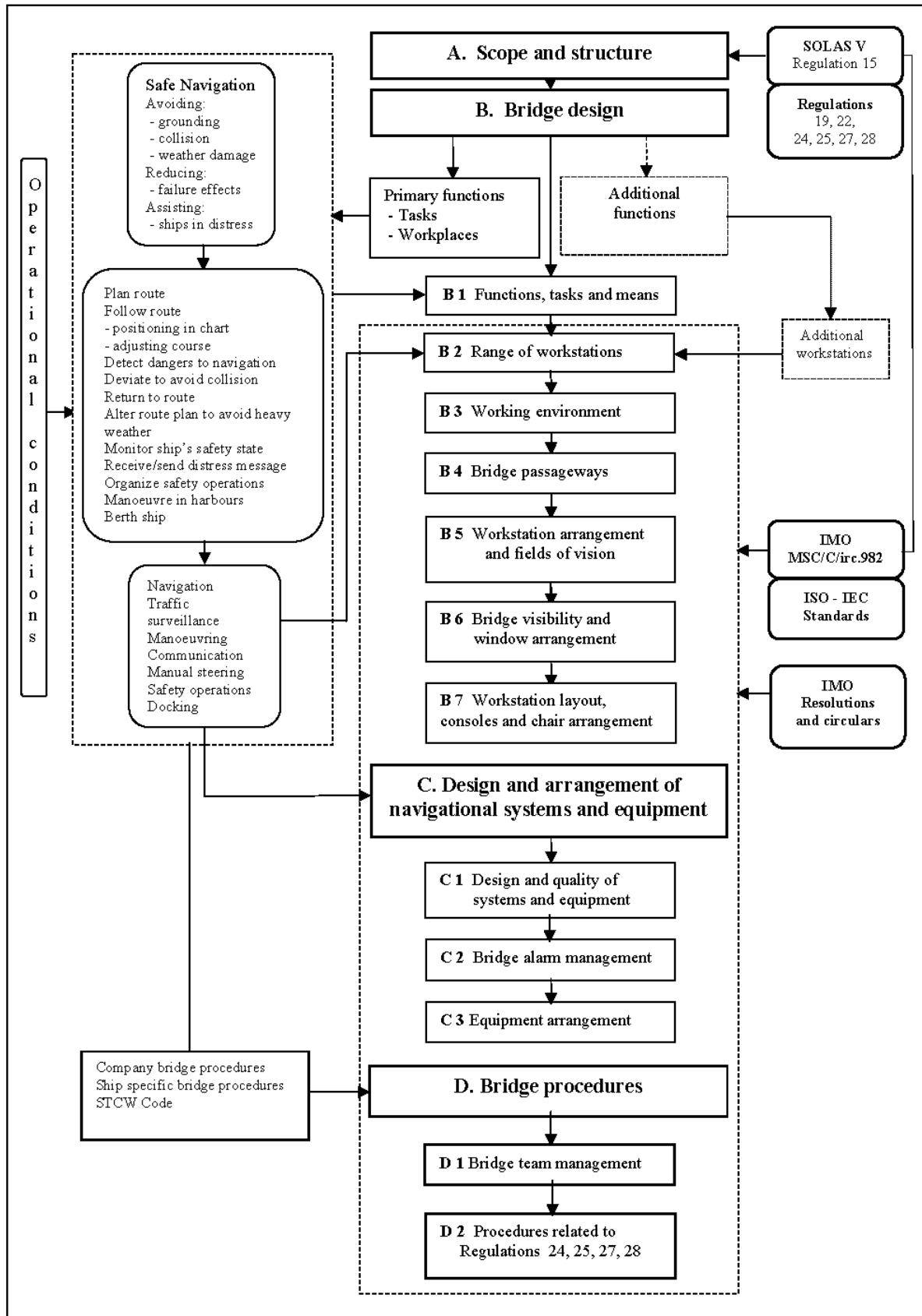

Fig. Design principles of the requirements

## **1 GENERAL**

### **1.1 APPLICATION**

**1.1.1** The present Recommendations contain a set of requirements for compliance with the principles and aims of SOLAS regulation V/15, when applying the requirements of the following regulations of SOLAS Chapter V:

- 19 "Carriage requirements for shipborne navigational systems and equipment";
- 22 "Navigation bridge visibility";
- 24 "Use of heading and/or track control systems";
- 26 "Steering gear: testing and drills";
- 27 "Nautical charts and nautical publications";
- 28 "Records of navigational activities" taking regulations 18 and 20 into consideration.

The requirements of these regulations are harmonized with the guidelines of MSC/Circ.982 and the relevant ISO and IEC standards.

Note. Refer to Annex 1.

### **1.2 STRUCTURE AND APPLICATION**

**1.2.1** The present Recommendations are structured to reflect the areas and aims addressed by regulation 15.

#### **1.2.1.1 Requirements.**

The requirements cover the provisions of Chapter V of SOLAS-74 and applicable parts of MSC/Circ.982, enabling the present Recommendations to be used as a stand-alone document for the purpose of development and subsequent approval of the appropriate technical documentation relating to the following areas of:

- bridge design;
- design and arrangement of navigational systems and equipment;
- bridge procedures.

#### **1.2.1.2 Guidance note.**

Guidance notes as how the requirements may be met by the acceptable technical solutions or other remedies are given when applicable. A guidance note given does not in any way exclude the alternative solutions that may fulfill the purpose and intention of the said requirements, providing other requirements and the overall bridge functionality are not adversely affected.

#### **1.2.1.3 Annexes.**

There are two annexes attached to the present Recommendations. Annex 1 contains three individual parts for clarification and consideration of:

- application of SOLAS regulation V/15;
- documents referred to by regulation 15 and the SOLAS regulations to be applied cross-referencing the individual aims of regulation 15 and the regulations affected;
- the effect of MSC/Circ.982 on the requirements of SOLAS regulation V/22 "Navigation bridge visibility" by comparison and harmonization of content.

Annex 2 contains examples of arrangement of main equipment on the bridge.

**1.2.2** The content of separate parts of the present Recommendations are structured with the aim of enabling it to serve as a rational checklist through the different levels of development and approval of the technical documentation.

**1.2.3** Approval of the technical documentation developed on the basis of the present Recommendations prove compliance with the requirements of SOLAS regulation V/15 when applying SOLAS regulations V/19, V/22, V/24, V/25, V/27 and V/28 at the time of delivery of the newbuilding.

Verification of compliance with regulations V/19 and V/22 addressing technical requirements for bridge equipment and design, includes verification of the ability of the bridge design, layout and equipment arrangement to promote effective and safe bridge resource management.

Procedures established for bridge resource management and for the purposes specified in SOLAS regulations V/24, V/25, V/27 and V/28 shall be verified in compliance with the requirements of the ISM Code prior to delivery of the ship and becoming part of the ship's safety management system and included in the ISM certification.

### **1.3 NORMATIVE REFERENCES**

**1.3.1** Applicable parts of MSC/Circ.982 — Guidelines on ergonomic criteria for bridge equipment and layout;

MSC/Circ.603 — Guidelines on display sizes and techniques for navigational purposes;

IMO resolution A.694(17) — General requirements for shipborne radio equipment forming part of the global maritime distress and safety system (GMDSS) and for electronic navigational aids;

IMO resolution A.708(17) — Navigation Bridge Visibility and Functions — Annex: Guidelines on Navigation Bridge Visibility and Functions;

IMO resolution A.830(19) — Code on alarms and indicators, 1995.

### **1.4 INFORMATIVE REFERENCES**

**1.4.1** ISO and IEC standards referred to in MSC/Circ.982 for relevant additional information:

ISO 8468, Ship's bridge layout and associated equipment — Requirements and guidelines;

ISO 14612, Additional requirements and guidelines for centralized and integrated functions;

IEC 60945, Maritime navigation and radio communication equipment and systems — General requirements – Methods of testing and required test results;

IEC 61174, Electronic Chart Display and Information System (ECDIS) — Operational and performance requirements, methods of testing and required test results.

**1.4.2** International Management Code for the Safe Operation of Ships and for Pollution Prevention (ISM Code).

**1.4.3** Company and Ship Specific Bridge Procedures Manual.

**1.4.4** International Convention on Standards of Training, Certification and Watchkeeping for Seafarers, 1978, as amended (STCW Convention-78/95).

### **1.5 DEFINITIONS**

For the purpose of this document:

**1.5.1** **Alarm** means an alarm or alarm system, which announces by audible and visual means a condition requiring attention.

**1.5.1.1** **Accept** means manual silencing of an audible alarm.

**1.5.1.2** **Acknowledge** means action for silencing of audible alarm and bringing visual alarm to steady state.

**1.5.1.3** **Cancel** means manual stopping of a visual alarm after the cause has been eliminated.

**1.5.2** **Bridge** means the area, from which the navigation and control of the ship is exercised, including the wheelhouse and bridge wings.

**1.5.2.1** **Bridge wings** mean those parts of the bridge on both sides of the ship's wheelhouse, which, in general, extend to the ship's side.

**1.5.2.2** **Navigation bridge** means area of a wheelhouse or enclosed bridge allocated navigating functions and control of the ship, and which includes any additional bridge workstation to be used by the officer of the watch.

**1.5.2.3** **Totally enclosed bridge** means a bridge without open bridge wings, meaning that bridge wings form an integral part of an enclosed wheelhouse.

**1.5.2.4** **Wheelhouse** means enclosed area of the bridge.

**1.5.3** **Bridge functions** mean functions comprising tasks related to operation of the ship and carried out on the bridge.

**1.5.3.1** **Primary bridge functions** mean functions related to determination, execution and maintenance of safe course, speed and position of the ship in relation to the waters, traffic and weather conditions.

Such functions are:

route planning functions;

navigation functions;

collision avoidance functions;

maneuvering functions;

docking functions;

monitoring of safety systems;

external and internal communication related to safety in bridge operations including distress situations;

pilotage functions.

**1.5.3.2** **Additional bridge functions** mean functions related to ship operations, which shall be carried out on the bridge in addition to primary functions, but not necessarily by the watch officer. Examples of such functions are:

extended communication functions;

monitoring and control of ballasting and cargo operations;

monitoring and control of machinery;

monitoring and control of domestic systems.

**1.5.4** **Close to** means within functional reach (inside the wheelhouse).

**1.5.5** **Collision avoidance functions** mean detection and plotting of other ships and moving objects; determination and execution of course and speed deviations to avoid collision.

**1.5.6** **Commanding view** means view without obstructions, which could interfere with the navigator's ability to perform his main tasks, covering at least the field of vision required for safe performance of collision avoidance functions (225°).

**1.5.7** **Conning station or position** means place in the wheelhouse with a commanding view, providing the necessary information for conning and which is used by navigators, including pilots, when monitoring and directing the ship's movements.

**1.5.8** **Docking** means maneuvering the ship alongside a berth while controlling mooring operations.

**1.5.9** **Maneuvering** means operation of steering systems and propulsion machinery as required to move the ship into predetermined directions, positions or tracks.

**1.5.10** **Monitoring** means act of constantly checking information from instrument displays and environment in order to detect any irregularities.

**1.5.11** **Navigation** means planning of the ship's route and determination of position and course of the ship, execution of course alterations and speed changes.

**1.5.12** **Operating conditions:**

**1.5.12.1** **Normal operating conditions** when all shipboard systems and equipment related to primary bridge functions operate within design limits, and weather conditions or traffic do not cause excessive operator workloads.

**1.5.12.2** Irregular operating conditions when external conditions cause excessive operator workloads.

**1.5.12.3** Abnormal operating conditions when malfunction of technical system requires operation of backup systems on the bridge, or when it occurs during an irregular operating condition, or when the officer of the watch becomes unfit to perform his duties and has not yet been replaced by another qualified officer.

**1.5.12.4** Emergency situations when incidents seriously affect internal operating conditions of the ship and the ability to maintain safe course and speed (fire, ship system technical failure, structural damage).

**1.5.13** Waters:

**1.5.13.1** Ocean areas mean waters that encompass navigation beyond the outer limits of coastal waters. Ocean areas do not restrict the freedom of course setting in any direction for a distance equivalent to 30 minutes of sailing with the relevant ship speed.

**1.5.13.2** Coastal waters mean waters that encompass navigation along a coast at a distance less than the equivalence of 30 minutes of sailing with the relevant ship speed. The other side of the course line allows freedom of course setting in any direction for a distance equivalent to at least 30 minutes of sailing with the relevant speed.

**1.5.13.3** Narrow waters mean waters that do not allow the freedom of course setting to any side of the course line for a distance equivalent to 30 minutes of sailing with the relevant ship speed.

**1.5.14** Route planning means pre-determination of course lines, radius turns and speed in relation to the waters to be navigated.

**1.5.15** Workstation means a workplace, at which one or several tasks constituting a particular activity are carried out, and which provides the information and equipment required for safe performance of the tasks.

**1.5.16** Workstation for monitoring means a workstation facilitating equipment and a commanding view for observation of the ship's heading and speed, the waters and traffic, incorporating means as required for positioning of the ship, and if located close to the front windows may serve as conning station for the master and a pilot carrying out control and advisory functions.

**1.5.17** Workstation for navigating and maneuvering means a workstation with commanding view used by navigators when carrying out navigation, route monitoring, traffic surveillance and maneuvering functions, and which enables monitoring of the safety state of the ship.

**1.5.18** Workstation for radio communication means a workplace for operation and control of equipment for Global Maritime Distress and Safety System (GMDSS), and shipboard communication for ship operations.

**1.5.19** Workstation for safety operations means a workplace-dedicated organization and control of internal emergency and distress operations, and which provides easy access to information related to the safety state of the ship.

## **1.6 DOCUMENTATION TO BE SUBMITTED BY THE SHIPBUILDER FOR APPROVAL**

**1.6.1** Fields of vision drawings showing:

**.1** the horizontal field of vision from the various workstations, including the arc of individual blind sectors and the sum of blind sectors forward of the beam (over an arc of 180° from side to side right ahead);

**.2** the vertical field of vision over the bow from the conning station and the workstation for navigation and maneuvering, including the line of sight under the upper edge of the window from standing working position at the workstation;

**.3** window arrangement, including inclination, dimensions, framing and height of lower and upper edge above bridge deck surface as well as the height of the deckhead.

**1.6.2** Bridge layout drawings showing:

.1 the bridge layout, including the configuration and location of all bridge workstations, including workstations for additional bridge functions (refer also to 7.1);

.2 configuration and dimensions of workstation consoles including console foundations.

**1.6.3** Equipment location drawings showing:

.1 location of instruments and equipment in all workstation consoles;

.2 location of equipment located elsewhere on the bridge (refer also to 7.1).

**1.6.4** List of equipment showing:

all relevant bridge equipment with specification of type, model, manufacturer, supplier and type approval reference with extension date or copy of valid certificates, when applicable.

**1.7 DOCUMENTATION TO BE SUBMITTED BY THE SHIPBUILDER FOR INFORMATION**

**1.7.1** Manuals or instructions for equipment installed for the use of bridge personnel shall be submitted for information upon request.

**1.8 DOCUMENTATION TO BE SUBMITTED BY THE SHIPOWNERS FOR APPROVAL**

**1.8.1** Ship specific bridge procedures covering:

the use of the heading and/or track control system, operation of steering gear, updating of nautical charts and recording of navigational activities proving compliance with SOLAS regulations V/24, V/25, V/27 and V/28.

**1.8.2** Paragraph 1.8.1 shall be included in the ship's management plan for the ISM certification.

**1.9 DOCUMENTATION TO BE SUBMITTED BY THE SHIPOWNERS FOR INFORMATION**

**1.9.1** If navigational functions and bridge team management shall be carried out or organized other than as indicated in these Recommendations (refer to 2.1 and 4.1), documentation describing the differences and operational procedures shall be submitted in conjunction with relevant drawings of bridge layout and equipment location submitted by the shipbuilder for approval (refer to 1.5.2, 1.5.3).

**1.9.2** Description of functions to be performed at workstations, which are additional to workstations for primary bridge functions, shall be submitted.

**1.9.3** Ship specific bridge procedures covering:

distribution of bridge functions and tasks (refer to 2.1);

manning and training requirements on the bridge at identified operating conditions taking into account the requirements in 2.1.

Note. Paragraph 1.9.3 shall be included in the ship's safety management system (SMS) under the ISM Code.

**1.10 ON BOARD TESTS**

**1.10.1** A program for the on board testing of the bridge equipment and systems required to be carried, as well as additional navigation equipment installed, shall be submitted for approval at the earliest possible stage before sea trials.

**1.10.2** Equipment and systems shall be subject to the tests required to ascertain that all controls, indicators, displays, etc., operate in accordance with their specifications and meet IMO requirements.

**1.10.3** Failure conditions shall be simulated on equipment and systems.

The bridge shall be designed and arranged with the aim of:

- facilitating the tasks to be performed by the bridge team and the pilot in making full appraisal of the situation and in navigating the ship safely under all operational conditions;
- promoting effective and safe bridge resource management;
- allowing for expeditious, continuous and effective information processing and decision-making by the bridge team and the pilot;
- preventing or minimizing excessive or unnecessary work and any condition or distraction on the bridge, which may cause fatigue or interfere with the vigilance of the bridge team and the pilot.

The design of bridge is governed by:

- the functions and related tasks to be carried out on the bridge, systems used and methods of task performance;
- the range, layout and location of workstations required for performance of bridge functions;
- the fields of vision required for visual observations from each of the workstations;
- composition of the bridge team and the procedures required for safe operations under all identified conditions;
- the type and range of equipment to be provided for performance of the tasks at the individual workstations and elsewhere on the bridge.

## **2 BRIDGE DESIGN**

### **2.1 FUNCTIONS, TASKS AND MEANS**

**2.1.1** Table 2.1 shows the main bridge functions and tasks to be carried out on the bridge. The types of approved equipment that are related to the performance of different tasks are indicated. The list may serve as basis for outfitting of workstations. The type of equipment installed on the individual bridge, the system configurations and automation level may affect the method of navigation, operational procedures and qualification levels.

It is regarded as the responsibility of the shipowners and users that procedures, knowledge and training of the bridge personnel are related to the individual ship's bridge system, including the task and means defined below, for safe and efficient task performance. Such issues shall be documented in the company and ship specific bridge procedures manual and documented in the ISM Code procedures manual for the vessel (refer to 1.8.1 and 1.8.2).

### **2.2 TYPE AND RANGE OF WORKSTATIONS**

**2.2.1** The ship's navigation bridge shall not be used for purposes other than navigation, communications and other functions essential to the safe operation of the ship, its engines and cargo, and workplaces shall be arranged with the aim of:

- facilitating the tasks to be performed by the bridge team and the pilot in making full appraisal of the situation and in navigating the ship safely under all operational conditions;
- promoting effective and safe bridge resource management.

**2.2.2** Individual workstations for performance of primary bridge functions including conning position for pilotage shall be provided for:

- navigating and maneuvering (and traffic surveillance);
- monitoring;
- manual steering;
- docking on bridge wings;



Table 2.1.1

Tasks and means			
Tasks to be performed	Equipment to be operated	Information to be viewed	Remarks
<i>Navigation</i> – <i>Grounding avoidance</i>			
Planning			
Plan route prior to departure	Paper chart/table Nautical publications GNSS		
Alter route while under way	ECDIS* ECDIS backup**		*Optional installation **If replacing paper
In Transit			
Monitor route-keeping: - Determine position by bearings - Read position on display - Plot position	Pelorus/gyro repeater* Radar GNSS Paper chart/table		*Analogue Bearings 360° around the horizon, (one on each bridge wing)
- Determine and plot position automatic	ECDIS		Optional installation
Maintain route/alter course by - manual steering - using autopilot - automatic route-keeping	Manual steering control Heading control system Track control system* (ECDIS)		*Alternative to heading control Interfaced to ECDIS, gyro, speed, radar when part of INS
Give sound signals	Whistle control		Fog – traffic
Receive sound signals	Sound reception system	Loudspeakers	Totally enclosed bridge
Monitor/Take action: - operational warnings - system failure alarms	Alarm panel		
- ship's safety state	Alarm systems		
Monitor heading, turn, rudder angle, speed, propulsion		Gyro repeater Indicators: - rudder angle - rate-of-turn - RPM, Pitch - speed log	
Adjust lighting	Dimmer buttons		
Monitor shallow water areas	Echo Sounder system	Water depth	(Anchoring)
Monitor performance automatic route-keeping system		Conning info display	Organizing indicator info providing situation awareness when in automatic route-keeping mode
Effect internal communication	Intercom (auto telephone)		
Effect external communication	VHF		Related to navigation
Receive/send distress message	GMDSS equipment or remote control		

Table 2.1.1 — continued

Tasks and means			
Tasks to be performed	Equipment to be operated	Information to be viewed	Remarks
<i>Traffic surveillance</i> - <i>Collision avoidance</i>			
Detect floating targets Analyse traffic situations Observe visually  Decide on collision avoidance measures	Radar with ETP* (may incl. AIS) Binoculars Window wiper -cleaning - heating control AIS (automatic identification system)	Targets' relative position, course, speed. Expected passing distance Time Target true position, course, speed	*Electronic target plotting ("historical" data)  Regarded additional info (means)
Manoeuvring			(For route-keeping)
Change steering mode	Steering mode switch		
Alter heading	Heading control	Heading (Gyro)	
Observe rudder angle		Rudder angle	
Override steering	Override control		
Manual steering control			
Change speed	Propulsion control	RPM/Pitch	
Give sound signals	Whistle control		
Receive sound signals	Sound reception system	Loudspeaker	Totally enclosed bridges
Navigate back to route	Paper chart/table GNSS		
Maintain track of traffic	Radar with route and navigable waters ECDIS*		*May replace paper
Harbour manoeuvring	Thruster		Optional
Anchoring			
Manoeuvre  Positioning (Identify anchor position)	Manual steering control Propulsion control (Thruster control.) Radar Chart GNSS	Heading Rudder angle RPM/Pitch Water depth	Performed at front workstations or in combination with docking station Information to be provided for pilots
Observe ship's safety state			
Monitor alarm conditions: - Navigation alarms Equip. & system failures Operational warnings	Main alarm panel W/indicators and acceptance button	Alarm list	Refer to 3.2
- Machinery alarms	Alarm panel		
- Cargo alarms	Alarm panel		
- Fire alarm	Fire alarm panel		
<i>Manual steering</i>			(Rating)
Maintain, adjust, alter heading according to order	Steering control Intercom (Public address system)	Gyro repeater Magnetic comp. Rudder angle Rate-of-turn	

Tasks and means			
Tasks to be performed	Equipment to be operated	Information to be viewed	Remarks
<i>Conning functions</i>			
Determine & direct course and speed in relation to waters and traffic			
Monitor:			
- heading		Gyro repeater	May be digital
- rudder angle		Rudder angle	
- rate-of-turn		RoT indicator	
- propulsion		RPM/Pitch	

Table 2.1.1 — continued

Tasks and means			
Tasks to be performed	Equipment to be operated	Information to be viewed	Remarks
- speed		Speed log	
- water depth		Echo sounder display	Anchoring
Give sound signals	Whistle control button		
Effect communication	VHF		Available

Tasks and means			
Tasks to be performed	Equipment to be operated	Information to be viewed	Remarks
<i>Safety operations</i>			
Take action on alarm condition: - analyse situation - consult plans and drawings	Manuals – Drawings – (PC)		May be computer based info
- observe ship's external operational situation			Cooperation with navigating officer
- organize and execute measures by communication - check status of ventilation system	Intercom (UHF) Emergency stop		
Monitor development of alarm conditions	Alarm panel/screen		
- Cargo alarms	Alarm panel		
- Fire detection & alarms	Fire detection and alarm panel		
- Gas & smoke detection			
<i>External communication</i>			
Distress - weather - safety	GMDSS equipment		As required (Area)
Determine weather conditions Consider navigation warnings	Navtex receiver		
Public correspondence	Additional equipment		Specified by owners

<i>Docking operations (bridge wings)</i>			
Directing steering	Intercom (Public address system)	Heading Rudder angle	
Directing speed	Intercom (Public address system)	RPM/Pitch	
Giving sound signals	Whistle control button		
Receiving sound signals	Sound reception system	Loudspeaker	Totally enclosed bridge
Perform manoeuvring	Steering Propulsion control Thruster control		Additional installation by owners
<i>Additional functions</i>			Refer to 2.2

planning (of voyage, routes, ship operations);  
safety (monitoring and emergency operations);  
communication (GMDSS);  
conning (pilot) (refer also to Guidance note of 2.5.12);

**Guidance note.**

The workstation for monitoring may be combined with:

a workplace for navigation (route monitoring/position-fixing) when the workstation for navigation and maneuvering provides individual workplaces for traffic surveillance and navigation (chart work);

a backup workstation for navigation and a conning position when electronic chart display and information system (ECDIS) is installed, enabling navigation, traffic surveillance and maneuvering at one workplace.

**2.2.3** Additional workstations may be arranged for performance of other functions than those related to primary bridge functions when relevant.

**Guidance note.**

The main types of additional bridge workstations may be divided into two distinct categories (A and B) based on purpose and functions and whether they shall be operated by the watch officer or not.

A. Workstations for functions regarded related to operation of the ship, its engines and cargo:

a) to be monitored and controlled by the watch officer;

b) to be used by other personnel than the watch officer.

B. Workstations for functions not regarded essential to safe operation of the ship and to be used by other personnel than the watch officer, but located on the bridge for practical reasons.

The type of tasks to be performed at the individual workstation and the operating procedures employed may conclude whether a workstation of category A shall be of type a) or b). Workstations of category A, type a) shall not include tasks that may prevent the officer in charge of primary bridge functions to leave a workstation for additional functions instantly at any time during operations.

Refer to 2.5.14 — 2.5.16.

## 2.3 WORKING ENVIRONMENT

**2.3.1** The bridge shall be designed and arranged with the aim of:

preventing or minimizing excessive or unnecessary work and any condition or distraction on the bridge, which may cause fatigue or interfere with the vigilance of the bridge team and the pilot.

Internal environmental conditions on the bridge that may affect human performance are:

temperature;

humidity;

ventilation;

noise;

vibration;

illumination and type of lighting;

glare and reflection;

interior colors;

occupational safety.

**2.3.2** The enclosed bridge or wheelhouse shall be equipped with an air conditioning or ventilation system for regulation of temperature and humidity.

**Guidance note.**

It shall be possible to maintain a temperature, which is not less than 18 °C in cold climates and does not exceed 27 °C in tropical climates, and to maintain the relative air humidity in the range of 20 to 60 %, preferably maintaining 45 % humidity at 21 °C and not less than 20 % at any temperature.

**2.3.3** Ventilation system with suitable air flow velocity and rate of air circulation shall be provided. Direction of air flow from air conditioning and heating systems towards workplaces shall be avoided.

**Guidance note.**

The preferred air velocity is 0,3 m/s and shall not exceed 0,5 m/s.

The recommended rate of air circulation for enclosed spaces is 6 complete changes per hour.

**2.3.4** Excessive levels of noise interfering with voice communication, causing fatigue and degrading overall system reliability, shall be avoided.

**Guidance note.**

The sound level measured 1 m from the outlets of air distribution systems shall not exceed 55 dB(A). Noise levels produced by individual bridge equipment shall not exceed 60 dB(A) at 1 m.

**2.3.5** Vibrations when the ship is at normal transit speeds shall not affect the reading of indicators or the comfort of personnel.

**2.3.6** Lighting arranged for adjustment of illumination and direction of light shall be provided at all workplaces. The illumination brightness shall be sufficient for safe performance of the tasks and possible to dim down to zero.

**2.3.7** Lighting that may be required for continuous operations during darkness and in entrances to the bridge shall be red with adjustable brightness to suit the operations and ease visual adaptation to darkness.

**2.3.8** It shall be possible to dim equipment displays and indicators providing information to individual workstations and red lighting covering the workstation area, at the workstation in use.

**2.3.9** Light sources shall be arranged and located in a way that prevents glare, stray image and mirror effects in bridge windows and deckhead areas above workstations.

**Guidance note.**

Deckhead areas above workstations shall have a dark colour of matt, anti-gloss type minimizing light reflection. The colour of bridge bulkheads shall have a calm and matt appearance.

**2.3.10** To reduce the risk of personnel injury during bridge operations:

the wheelhouse floor, bridge wings and upper bridge decks shall have non-slip surfaces;

hand- or grab-rails shall be installed as required at workstations, passageways and entrances, enabling personnel to move and stand safely when the ship is rolling and pitching in heavy weather;

chair deck rails installed at workstations shall be provided with anti-trip skirting board or be flush mounted;

stairway openings shall be protected if not sufficiently lit or otherwise indicated during darkness.

**2.3.11** Personnel safety equipment to be stored on the bridge shall be clearly marked and easily accessible.

## **2.4 BRIDGE PASSAGEWAYS**

**2.4.1** Bridge passageways shall facilitate the expected movement of the bridge team between individual workstations, bridge entrances, exits and windows in carrying out the bridge tasks safely and effectively including the maintenance of equipment.

**2.4.2** A clear route across the wheelhouse, from bridge wing to bridge wing for two persons to pass each other, shall be provided.

**Guidance note.**

The width of the passageway shall be 1200 mm and not less than 700 mm at any single point of obstruction.

**2.4.3** The distance between separate workstation areas shall be sufficient to allow unobstructed passage for persons not working at the stations.

**Guidance note.**

The width of such passageways shall not be less than 700 mm, including persons sitting or standing at their workstations.

**2.4.4** The distance from the bridge front bulkhead, or from any console and installation placed against the front bulkhead to any console or installation placed away from the bridge front, shall be sufficient for one person to pass a stationary person.

**Guidance note.**

Where there is a passageway between the front bulkhead and front workstation consoles, its width shall preferably be 1000 mm and not be less than 800 mm. When the front workstation is placed against the front bulkhead, the guidelines of 2.4.2 may be applicable, or 2.4.3 if there is a passageway providing a clear route from bridge wing to bridge wing aft of the workstation.

**2.4.5** The distance between bridge wing consoles and bulkheads shall be as little as possible for easy operation of controls from both a position behind and beside the console giving optimum view of the ship's side and the mooring operations, but wide enough for one person to pass the console.

**Guidance note.**

The width of the passageway shall be 600 mm.

*Note.* The Panama Canal Commission (PCC) requires that a minimum of 1 meter clearance from consoles or obstructions shall be provided from the forward to aft portions of the bridge wing ends. Special requests for relaxation of this requirement may be considered on a case-by-case basis.

**2.4.6** The clear deckhead height in the wheelhouse shall take into account the installation of deckhead panels and instruments as well as the height of door openings required for easy entrance to the wheelhouse. The following clear heights for unobstructed passage shall be provided:

**.1** the clear height between the bridge deck surface covering and the underside of the deck head covering shall be at least 2250 mm;

**.2** the lower edge of deck head-mounted equipment in open areas and passageways, as well as the upper edge of door openings to bridge wings and other open deck areas shall be at least 2100 mm above the deck;

**.3** the height of entrances and doors to the wheelhouse from adjacent passageways shall not be less than 2000 mm.

## 2.5 WORKSTATION ARRANGEMENTS AND REQUIRED FIELDS OF VISION

**2.5.1** The workstations for primary bridge functions shall be arranged to serve their functions under all operating conditions and different manning of the bridge and provide the fields of vision required for visual observations and easy cooperation between bridge personnel, promoting effective and safe bridge resource management.

**2.5.2** Workstations for navigating and maneuvering, including traffic surveillance and monitoring shall be arranged within an area spacious enough for two persons to carry out the tasks in close cooperation, but sufficiently close together to enable the watch officer to control and safely carry out all the tasks from one working area under normal operating conditions.

**Guidance note.**

The workstation for navigating and maneuvering shall be arranged to allow an assisting officer to carry out route monitoring, which may include position-fixing and chart work, and course adjustments when ordered, while the officer in charge concentrates on traffic situations and adjustment of course and speed as required to follow the route and avoid danger of collision.

The workplaces shall be adjacent to enable easy communication and cooperation when two navigators operate the workstation, and to provide the watch officer with a workstation for safe and efficient performance of all the tasks when he is the only navigator on the bridge and is to use both the workplace for route monitoring/position-fixing and the workplace for traffic surveillance/maneuvering.

*Note.* The workplace for position-fixing and chart work is regarded a workstation for monitoring also when in use by an assisting officer and may serve as a workplace for the use of backup chart systems and for conning when ECDIS is installed at the workplace for traffic surveillance.

The table shows the relative location of workplaces based on manual position-fixing in paper charts allowing efficient performance by the single watch officer under normal operating conditions and two persons in close cooperation when the workload exceeds the capacity of the watch officer.

Position-fixing Chart work Monitoring	Alarms Commun Manoeuvr	Traffic surveillance
---	------------------------------	----------------------

Workstation arrangement with work places for navigation and maneuvering — monitoring.

When an electronic chart system is installed, enabling route monitoring, traffic surveillance and maneuvering from one working position, the workplace for monitoring may be used by pilots for conning if located close to centre windows. Work places when arranged for the use of electronic chart system incorporating automatic position-fixing (ECDIS with backup):

Backup nav. system Monitoring Conning	Alarms Commun Manoeuvr	Traffic surveillance Automatic pos.-fix.
---	------------------------------	---

Workstation arrangement for navigation and maneuvering — monitoring — conning.

**2.5.3** Workplaces for performance of navigation, traffic surveillance and monitoring shall be arranged for working in standing as well as seated position with optimum field of vision.

**2.5.4** The field of vision from the bridge shall be provided, facilitating the tasks to be performed by the bridge team and the pilot in making full appraisal of the situation and in navigating the ship safely under all operating conditions by enabling visual observations for performance of bridge functions at the workstations specified in 2.2.

**2.5.5** It shall be possible to observe all objects of interest for the navigation such as ships and lighthouses, in any direction from inside the wheelhouse by providing a horizontal field of vision to the horizon of 360° within the confines of the wheelhouse.

**Guidance note.**

On a bridge with enclosed bridge wings it shall be possible to obtain the view of 360° from inside the bridge area by using two positions, one on each side of the workstation for navigation and maneuvering, not being more than 15 m apart. This guideline may also be applicable for providing the required field of vision within the confines of wheelhouses with a total breadth of more than 18 m.

**2.5.6** From the conning position and the workstation for navigating and maneuvering, the view of the sea surface forward of the bow to 10° on either side under any ballast or cargo condition shall not be obscured by more than 2 ship's lengths or 500 m, whichever is the less. Each individual blind sector shall not exceed 5°.

**2.5.7** The workstation for navigating and maneuvering and the conning position shall provide a field of vision enabling maintenance of visual traffic surveillance, extending over a forward arc of not less than 225° that is from right ahead to not less than 22,5°, abaft the beam on either side of the ship. From a workstation for monitoring, a blind sector covering the view abaft the beam on port side is accepted.

**Guidance note.**

All workstations to be used by the officer of the watch shall provide a forward field of vision of 225°. A blind sector covering the view abaft the beam on port side may be accepted for workstations to be used infrequently by the watch officer for short periods at a time and for workstations to be used by assisting officers.

**2.5.8** Workstations for monitoring, navigating and maneuvering shall provide the required fields of vision from a seated working position and shall not be located directly behind large masts, cranes etc., which obstruct the view right ahead from the workstation.

**2.5.9** A separate blind sector formed by the ship's cargo, cargo lifting equipment or another obstacle forward of (in 180° sector) the ship's wheelhouse and restricting the sea surface scanning from the workstation shall not exceed 10°. The resulting blind sector shall not exceed 20°. The sectors of unrestricted observation area between blind sectors shall be at least 5°. However, for the scanning described in 2.5.6 of this Appendix, each separate blind sector shall not exceed 5°.

**Guidance note.**

To help reducing the size of internal blind sector caused by bridge wing bulwarks and divisions between windows in bridge wing bulkheads, such bulwarks and bulkheads shall be located in a line of sight seen from the working position at the front workstations.

**2.5.10** The workstation for manual steering shall preferably be located on the ship's centre line and shall not interfere with the functions to be performed by the officer of the watch. The steering position shall provide a forward field of vision not less than 60° to each side. If large masts, cranes, etc. obstruct the view in front of the workstation, it shall be located some distance to starboard of the centre line, sufficiently to obtain a clear view ahead.

**2.5.11** When the workstation for manual steering is located off centre, or the bow of the ship cannot be seen from the steering position, special steering references (sighting marks) shall be installed forward of the steering position. The steering references shall be installed in line parallel to the ship's centre line for use by day and by night.

**2.5.12** The ship's side shall be visible from the bridge wing. Equipment for docking operations from the bridge wings, or a workstation console if installed, shall be located to enable visual observations required for safe maneuvering of the ship, monitoring of tug and mooring operations and shall provide a field of vision from not less than 45° on opposite bow to right astern from the working position.

*Note.* The Panama Canal Commission (PCC) requires that the conning position located at the extreme end of the bridge wings provides a clear and unobstructed view fore and aft of the vessel's side. The side hull plating at the vessel's waterline, fore and aft, shall be visible from bridge wing conning positions.

**2.5.13** The conning position shall be located close to the front centre window to provide the pilot with a commanding external view, including a view of the sea surface sufficiently close to both sides of the ship's bow for safe directing of the steering in narrow canals and buoy lanes.

**Guidance note.**

The position for the conning station may be met by the workstation for monitoring/backup navigation when located sufficiently close to the forward centre window, provided the workstation is installed in addition to a complete workstation for navigation, traffic surveillance and maneuvering and therefore not required by the ship's personnel during pilotage (refer to Guidance notes of 2.2.2).

*Notes:* 1. The Panama Canal Commission (PCC) requires that the conning position be located "directly behind and next to" the centre front window and the nearest window thereto on each side that provides a clear and unobstructed view ahead for conning during canal transit. A minimum of 1 meter clearance from consoles or obstructions shall be provided. Special requests for relaxation of this requirement may be considered on a case-by-case basis.

2. PCC requires that the conning position shall provide a view of the sea surface forward of the bow from 1,5 ship's length when at ballast load line and 1 ship's length at full load line.

**2.5.14** There shall be a close approach access to at least one front window providing the view of the area in front of the bridge superstructure.

**2.5.15** Workstations for additional functions, which shall be used by the watch officer (refer to 2.2.2), shall provide the field of vision required to maintain efficient look-out in accordance with 2.5.6 and enable monitoring of the ship's heading and rudder angle.

**2.5.16** The location of a workstation for additional functions regarded essential for safe operation of the ship and to be used by other personnel than the watch officer shall not in any way influence the performance of primary bridge functions.

**2.5.17** Workstations for additional functions not essential to the safe operation of the ship, its engines and cargo, or furniture arranged for meetings or relaxation inside the wheelhouse shall not be installed within the area of the navigation bridge or within fields of vision outside this area, which are required for traffic surveillance from workstations. If such workstation or furniture arrangement is installed close to these areas, the use of it shall in no way influence the performance of primary bridge functions, either by use of light, noise disturbance or visual distraction.



**Guidance note.**

Fig. 2.5.17-1 shows the principles for bridge layout with front workstations arranged for operations in seated and standing position and with bridge wing bulkheads in line of sight from the working positions. A bridge area, which may be regarded outside the navigation bridge, and the sectors of required field of vision from workstations are indicated.

Position-fixing in paper charts — passageway and conning position in front.

Note to Fig. 2.5.17-2 (also valid for Fig. 2.5.17-3).

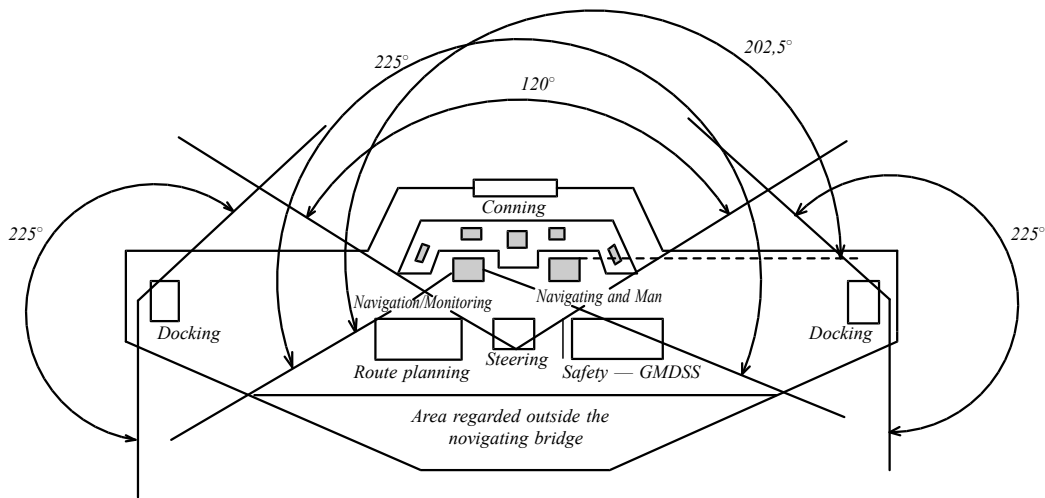

Fig. 2.5.17-1 Location of workstations and required fields of vision.  
Position-fixing in paper charts — Passageway and conning position in front

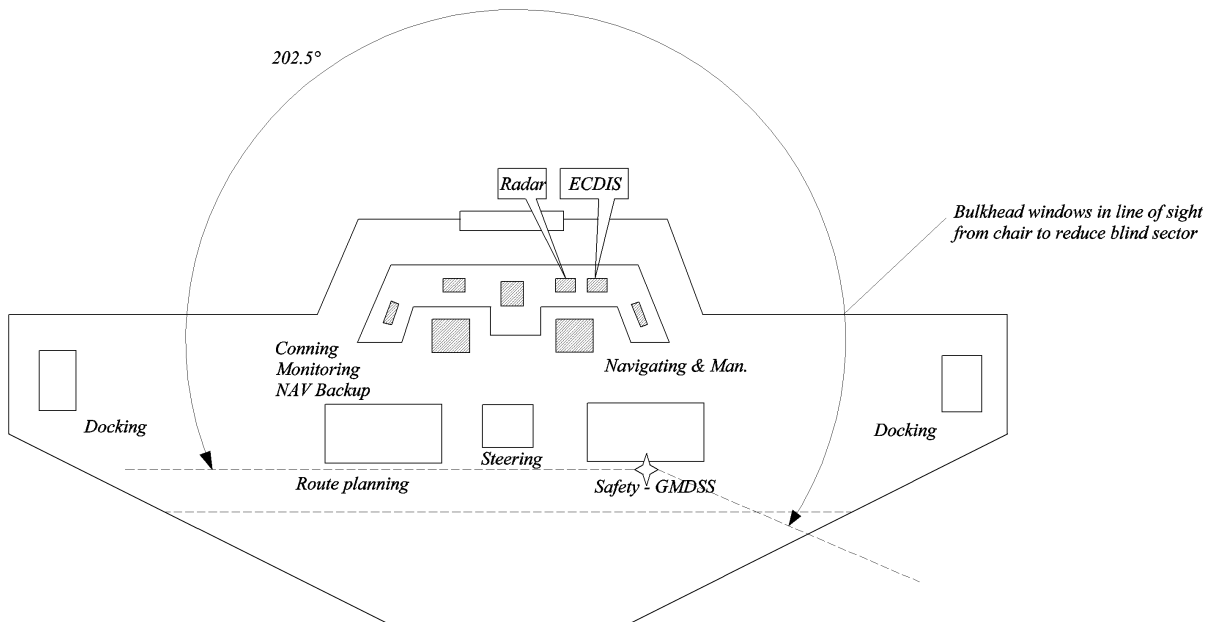

Fig. 2.5.17-2 Required field of vision from the radio station when to be controlled and infrequently used for short periods of time by the watch officer.

Navigation based on electronic chart system (ECDIS) — Conning position at console

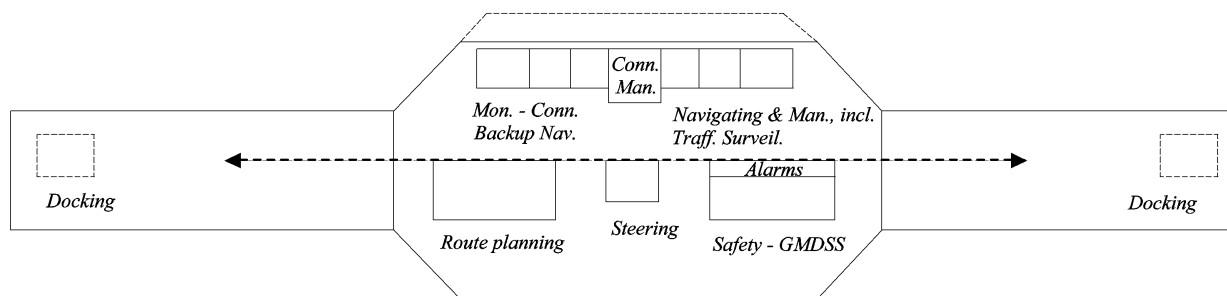

Fig. 2.5.17-3 Design principles — Flat front — Open bridge wings with passageway from door to door  
Consoles up front — Access to front window

Location of ECDIS at the workstation for navigating and maneuvering (including traffic surveillance) enables position-fixing at this position and makes the area a complete workstation (WS) for the navigation function and maneuvering. This leaves the workstation for navigation backup/monitoring available for conning when installed at the front bulkhead. Close approach access to front windows is maintained.

## 2.6 FIELDS OF VISION AND BRIDGE WINDOW ARRANGEMENT

**2.6.1** The bridge front windows shall be inclined from the vertical plane, top out, at an angle not less than  $10^\circ$  and not more than  $25^\circ$  to help avoid reflections. Polarized and tinted windows shall not be fitted.

### Guidance note.

The rear and side windows shall be inclined from the vertical plane top out, at an angle of  $4^\circ$  —  $5^\circ$  to help avoid reflections. If the arrangement of light sources meet the requirement of paragraph 2.3.9 without inclination of the side and rear windows, inclination may not be necessary.

*Note.* Bridges designed with enclosed bridge wings:  
inclined side windows, which extend the maximum breadth of the ship, may not be in accordance with requirements of the Panama Canal Commission for some ship sizes.

**2.6.2** The lower and upper edge of windows shall not present an obstruction to the view forward of the bow seen from a seated as well as a standing position at the workstations for monitoring, navigating and maneuvering.

### Guidance note.

The height of the lower edge of windows above the floor surface shall not exceed 1000 mm within the required field of vision and the height of the upper edge shall be at least 2000 mm.

**2.6.3** The upper edge of the front windows shall allow a forward view of the horizon for a person with a height of eye of 1800 mm at the navigating and maneuvering workstation when the ship is pitching in heavy seas. If 1800 mm height of eye is considered unreasonable and impractical, a reduction of the height may be accepted, but not to less than 1600 mm.

### Guidance note.

A vertical angle of view of not less than  $5^\circ$  above a horizontal line from a standing eye height of 1750 mm shall be provided (refer to Fig. 2.6.3).

**2.6.4** Framing between windows shall be kept to a minimum and not be installed immediately forward of any workstation. If stiffeners between windows shall be covered, this shall not cause further obstruction of the view.

### Guidance note.

The division between windowpanes within the required field of vision shall not exceed 150 mm. If stiffeners are used, divisions shall not exceed 100 mm in width and 120 mm in depth. The width of

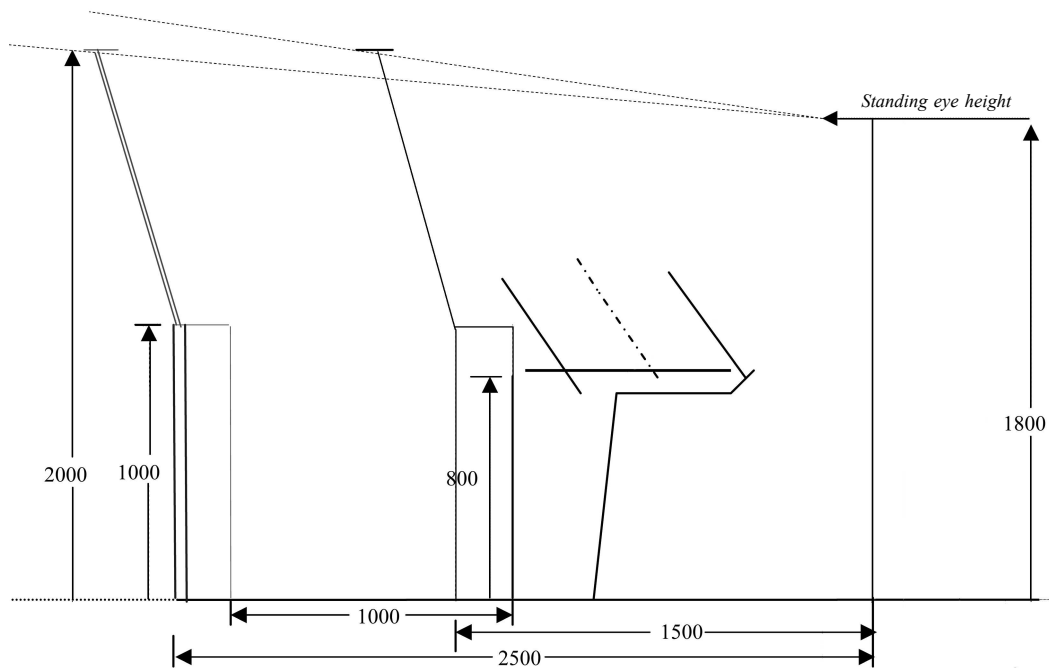

Fig. 2.6.3 With front windows at an angle of  $15^\circ$ , a vertical angle of view of  $5^\circ$  from an eye height of 1750 mm may be provided at a distance of 2600 mm from the front bulkhead, allowing for a passageway of 1000 mm in front of workstation consoles

windowpanes within the field of vision required for traffic surveillance shall not be less than 1200 mm in order to limit the number of stiffeners.

**2.6.5** To enable visual observations through windows to be maintained under all weather conditions, all windows within the required fields of vision from the working position at workstations to be used by bridge personnel, including pilots, shall provide a clear view regardless of weather conditions.

**Guidance note.**

The following means shall be installed to provide a clear view through windows:

- sunscreens of roller blind type;
- heavy duty blade type wipers and fresh water window washing;
- efficient de-icing and de-misting systems.

Technical systems installed shall comply with appropriate ISO standards (refer to ISO standard 17899).

A catwalk or other means to help maintenance of window wipers and manual cleaning of bridge front windows shall be provided.

## 2.7 WORKSTATION LAYOUT, CONSOLES AND CHAIR ARRANGEMENT

**2.7.1** The configuration of workstations and consoles shall provide a workplace for rational and user-friendly placing of equipment, with the aim of:

- facilitating the tasks to be performed by the bridge team and the pilot in making full appraisal of the situation and in navigating the ship safely under all operational conditions;
- promoting effective and safe bridge resource management;
- enabling the bridge team and the pilot to have convenient and continuous access to essential information;
- allowing for expeditious, continuous and effective information processing and decision-making by the bridge team and the pilot;

preventing, or minimizing, excessive or unnecessary work and any condition or distractions on the bridge, which may cause fatigue or interfere with the vigilance of the bridge team and the pilot.

**2.7.2** A functional workstation designed in accordance with the established overall operational and ergonomic requirements shall provide:

- a sufficient area for performance of the tasks to be carried out by the number of people that may be required to attend consoles designed for operations at specific workplaces in standing and seated position;
- enabling installation of equipment to be within reach from the working position;
- avoiding obstruction of the view through bridge windows from seated position;
- chairs suiting ergonomic requirements for efficient use of installed equipment and maintenance of fields of vision, if chairs shall be installed.

**2.7.3** The workstation for navigation and maneuvering shall have working positions for position-fixing, maneuvering and traffic surveillance as close as possible for efficient use by the officer of the watch, but also enabling the tasks to be performed by two navigators in close cooperation.

**Guidance note.**

The working position for operating the radar with collision avoidance functions shall be regarded the main working position at this workstation. Controls for course and speed adjustments shall be located within reach from this position to enable collision avoidance maneuvers without losing view of the traffic, and means for position-monitoring/-fixing shall be readily available.

Figs. 2.7.3-1 and 2.7.3-2 show examples of workstation layouts designed in compliance with 2.5.2. If ECDIS with backup (which is optional) is not installed, the chart table shall preferably be installed closer to the radar (refer to Fig. 2.7.3-3). Alternatively, spaces may be allocated for future ECDIS installation.

May suit wheelhouses with limited depth (longitudinal distance between front and rear bulkheads).

Includes space for conning information display and machinery monitoring system.

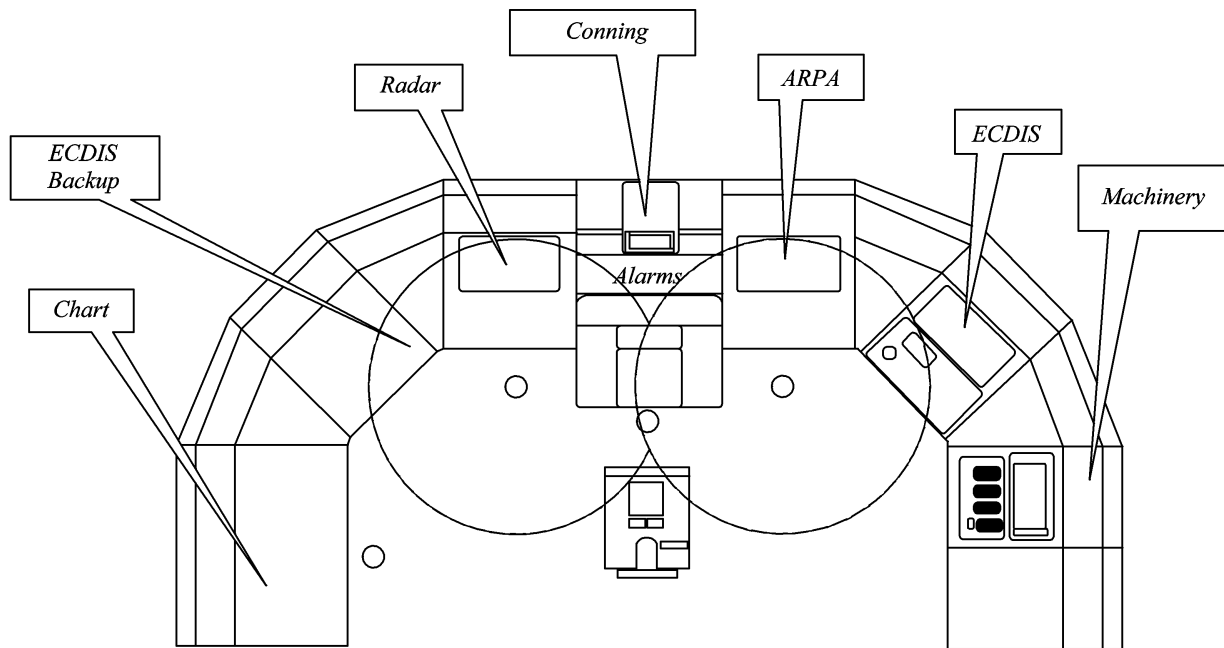

Fig. 2.7.3-1

Workstation layout which may include ECDIS with combined electronic and paper chart back up arrangement as well as conning information display monitoring of INS functions

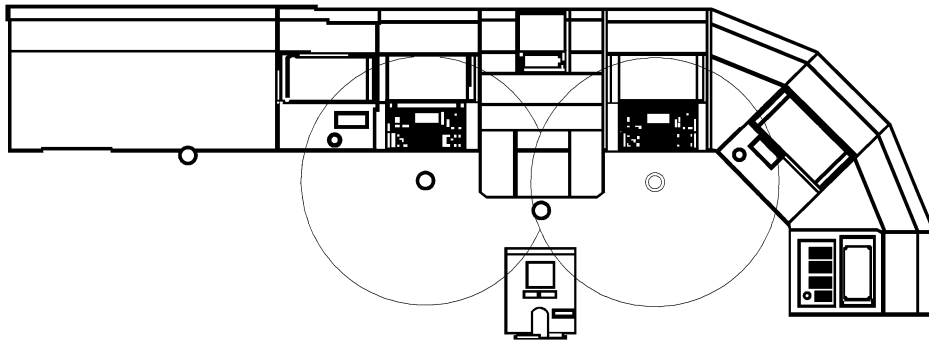

Fig. 2.7.3-2 A modified workstation configuration, based on same principles as shown in Fig. 2.7.3-1.

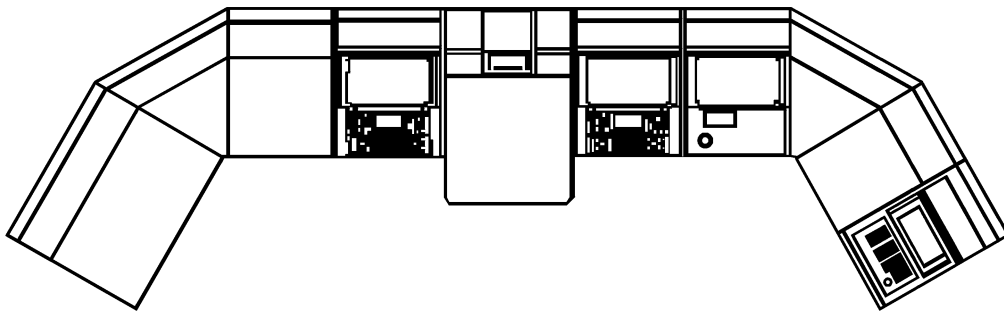

Fig. 2.7.3-3 A modified version of Fig. 2.7.3-2

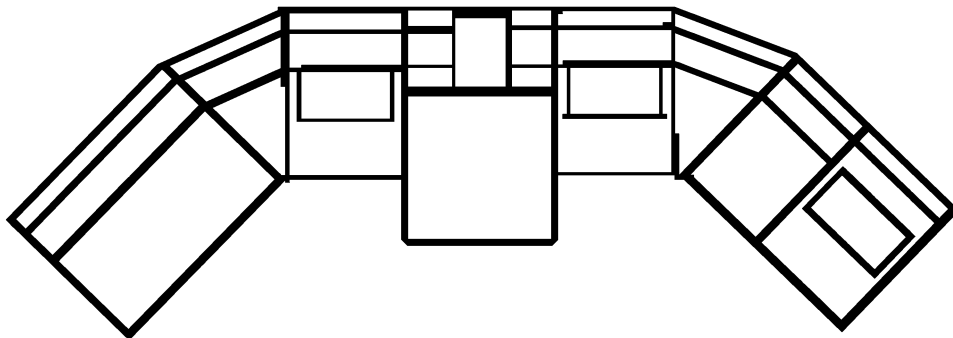

Fig. 2.7.3-4 Design principles similar to Fig. 2.7.3-3, but without electronic chart installations

**2.7.4** Consoles shall principally be divided into two areas:  
a vertical (slanting) part for location of information displays to be easily readable;  
a horizontal part (desktop) for controls, switches and buttons to be within easy reach from the working position.

**2.7.5** The height of console desktops at the workplaces for navigation, maneuvering, traffic surveillance and monitoring shall enable easy use of equipment required for safe performance of the tasks to be performed from both standing and sitting position.

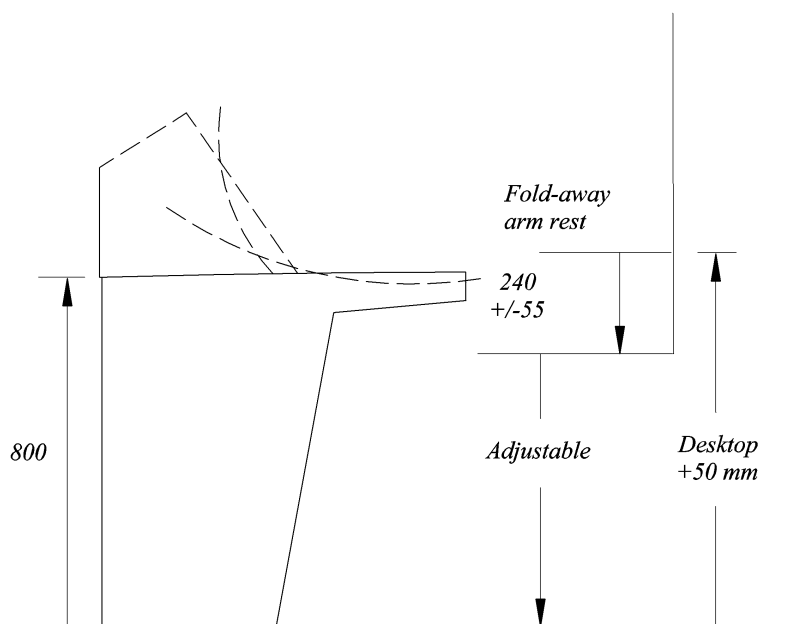

Fig. 2.7.5

**Guidance note.**

To provide a functional reach from standing position, the height of console desktops above bridge deck surface shall be 800 mm and not less than 750 mm. The sitting height is governed by the elbow height in relation to console desktop.

To provide a functional reach of equipment and easy operation of controls from sitting position the elbow height of the operator shall be preferably 50 mm higher than the console desktop and not less than the height of the desktop.

To provide the elbow height for persons of different size and build in relation to the console desktop, it shall be possible to adjust the height of the seat to allow the elbow height of 240 mm  $\pm$  55 mm above seat. It shall be possible to adjust chair armrests accordingly, if installed, and to fold the armrests away.

**2.7.6** The console in front of a seated working position shall provide sufficient leg room.

**Guidance note.**

The leg room shall have a depth of 450 mm and not less than required for a person sitting at a working position 350 mm from the console (chair backrest 440 mm from the edge of the console, requiring a leg room depth of at least 230 mm).

**2.7.7** The consoles forming the front workstations shall not be higher than required for efficient use in standing position and shall not obstruct the fields of vision over the lower edge windows in front of the workstation from sitting position.

**Guidance note.**

The console height shall not exceed 1200 mm. This console height may be accepted for installation at a distance of 350 mm or more from the window, also if it interferes with the line of sight from an eye height of 1400 mm, providing the height of the chair can be adjusted to compensate for the interference.

Note. Refer to 2.6.3 for eye heights at standing position.

**2.7.8** Consoles within the required fields of vision aft of the front workstation consoles shall not obstruct the horizontal line of sight from the sitting eye height.

**Guidance note.**

The height of the consoles shall be 100 mm lower than the horizontal line of sight and shall not exceed 1300 mm.

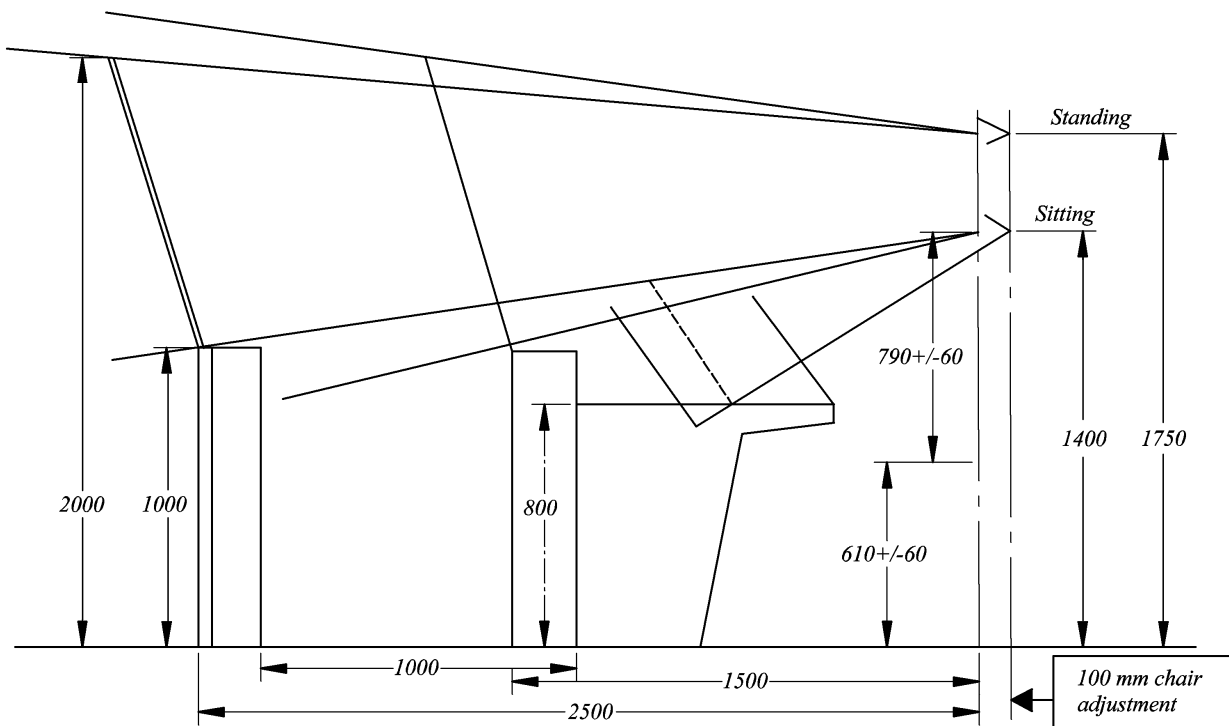

Fig. 2.7.8

**2.7.9** When a chair is installed at a workplace for operations in both standing and seated position, it shall be fastened to rails allowing fore and aft movement of the seat to enable easy reach of equipment when seated and sufficient room to stand in front of the console when the chair is pushed back. It shall be possible to adjust the height of the seat to suit users of different heights for optimum view and reaching distance and armrests, if provided, shall be of fold away type and preferably adjustable in height.

**Guidance note.**

The seat height of the chair shall be adjustable from 550 to 670 mm above the deck surface. The movement in fore-aft direction shall allow the front edge of the seat to be positioned at the edge of the front console and to allow a free space of at least 700 mm between the chair and console when moved in aft direction. Armrests shall preferably be adjustable from 185 and 295 mm above the seat, if installed.

### 3 DESIGN AND ARRANGEMENT OF NAVIGATIONAL SYSTEMS AND EQUIPMENT

Navigational systems and equipment shall be designed with the aim of:

- presenting the information in a clear and unambiguous manner, using standardized symbols and coding systems for controls and displays;
- indicating the operational status of automated functions and integrated components, systems and/or sub-systems;

- minimizing the risk of human error and detecting such error if it occurs, through monitoring and alarm systems, in time for the bridge team and the pilot to take appropriate action;

and be arranged with the aim of:

- facilitating the tasks to be performed by the bridge team and the pilot in making full appraisal of the situation and in navigating the ship safely under all operational conditions;

enabling the bridge team and the pilot to have convenient and continuous access to essential information;

allowing for expeditious, continuous and effective information processing and decision-making by the bridge team and the pilot.

### **3.1 DESIGN AND QUALITY OF NAVIGATIONAL SYSTEMS AND EQUIPMENT**

**3.1.1** Navigational systems and equipment shall be of approved type and comply with the applicable international requirements and requirements of the Register Rules.

*Note.* The basic design of navigational systems and equipment required to be carried is governed by functional and technical requirements as well as ergonomic and human-machine interface criteria expressed in individual IMO performance standards.

The quality of the human engineering part of the design of equipment and alarm functions shall be determined in performance tests and trials carried out during the approval process.

Alteration of hardware and software of type approved equipment requires review of the documentation by the type approving authority and may include re-testing to a certain extent, depending on the type of changes.

**3.1.2** Navigational equipment and systems offering alternative modes of operation shall indicate the actual mode in use.

**3.1.3** The system architecture of an integrated system shall include means providing situation awareness by indication of operational status of automated functions and the individual equipment.

**3.1.4** In case of failure in one part of an integrated navigation system, it shall be possible to operate every other individual item of equipment or part of the system separately.

### **3.2 BRIDGE ALARM MANAGEMENT**

**3.2.1** An alarm system shall be provided, indicating any fault requiring attention and shall:  
activate an audible and visual alarm on the navigation bridge for any situation, which requires action by, or attention of the officer of the watch;

as far as practicable be designed on the self-monitoring principle.

The bridge alarm system shall be designed with the overall aim of:

minimizing the risk of human error and detecting such error, if it occurs, through monitoring and alarm systems, in time for the bridge team and the pilot to take appropriate action.

The overall aim includes the aim of:

enabling the officer on watch to devote full attention to the safe navigation of the ship enabling immediate identification of any abnormal situation requiring action to maintain safe navigation of the ship;

avoiding distraction by alarms, which require attention but have no direct influence on the safe navigation of the ship and which do not require immediate action to restore or maintain the safe navigation of the ship.

Alarms and indicators on the navigation bridge shall be minimized and only alarms and indicators required by appropriate documents shall be placed on the navigation bridge, unless permitted by the flag administration (refer to IMO resolution A.830(19)).

**3.2.2** A method of accepting all alarms on the bridge (both the source of alarm and alarms of other equipment caused by the loss of sensor input) shall be provided at the navigating and maneuvering workstation to avoid distraction. The system shall enable immediate identification of the alarm sources without requiring any operator action and enable immediate silencing of the alarms by single operator action.

#### **Guidance note.**

A bridge management system shall include grouping of alarms and indicators, separating alarms that affect safety of navigation and alarms that do not influence safety of navigation.



The group of alarms related to safety of navigation shall incorporate all system alarms, equipment alarms and operational warnings that are critical to safety of navigation, including the detection of:

- operator disability;
- danger of collision heading;
- heading deviations;
- deviations from the route;
- danger of grounding;
- propulsion failure;
- steering gear failure.

Essential equipment and systems to be incorporated in such an alarm system shall include:

- bridge watch monitoring system;
- heading information system;
- heading/track control system;
- position-fixing systems;
- electronic chart system, if installed;
- radar with electronic target plotting functions;
- relevant machinery alarms for early warning.

All groups of bridge alarms and warnings shall be centralized in a common panel or screen at the workstation for navigation and maneuvering.

**3.2.3** Acknowledgement of an alarm at either the instrument or an alarm panel shall cancel the audible warning at both sources and change the visual alarm from flashing to constant light.

**3.2.4** Permanently inhibiting individual alarms shall not be possible, but manual suppression of local audible alarms may be accepted when this is clearly and constantly indicated at the equipment and the unit is part of the alarm management system.

**Guidance note.**

Local audible alarms may be manually suppressed by means of an on/off switch located on or close to the equipment or by other means, e.g. electronically. The off-position shall enable suppression of the audible alarm when the equipment is part of a central alarm system and the on-position shall engage the local alarm when the equipment serves as a stand-alone unit.

**3.2.5** If an alarm channel in a computer-based system is inhibited manually, then this shall be clearly indicated by a visual signal.

**3.2.6** Audible alarms shall be maintained until they are accepted and the visual identification of individual alarms shall remain until the fault has been corrected.

**3.2.7** Alarm indications shall be red, or if on displays, red or otherwise highlighted. If alarm messages are displayed on color VDUs, the alarm status shall remain visible in the event of the failure of one color of the display system.

**Guidance note.**

The following method of indication shall be applied:

**.1** active alarm status:

red, blinking and audible;

**.2** active alarm status acknowledged:

red, static (canceling the audible alarm);

**.3** active warning message — not critical:

yellow, static (may be accompanied by a short audible attention signal);

**.4** normal condition:

no light (indication of a safe situation).

**3.2.8** The alarm system shall be able to indicate more than one fault at the same time, and the acknowledgement of any alarm shall not inhibit another alarm, meaning that if an alarm has been acknowledged and a second fault occurs before the first is rectified, the audible and visual alarms shall operate again.

**3.2.9** A new alarm condition shall be clearly distinguishable from those existing and already acknowledged by indicating new alarms by a flashing light, and existing and accepted alarms by a constant light.

**Guidance note.**

In colour graphic systems, it shall not be possible to distinguish between the status of alarms and warnings by means of colour only.

**3.2.10** Provisions shall be made for functional testing of required alarms and indicators.

**3.2.11** The alarm system shall be continuously powered and shall have an automatic changeover to stand-by power supply in case of loss of normal power supply.

**3.2.12** Failure of the normal or backup power supply of the alarm system shall be indicated by an alarm.

**3.2.13** Loss of system communication shall be indicated by an alarm.

### **3.3 ARRANGEMENT OF NAVIGATIONAL SYSTEMS AND EQUIPMENT**

**3.3.1** The type and number of navigational systems and equipment to be carried shall at least incorporate the items specified in the present Part of the Recommendations, and shall be installed at the various workstations with the aim of:

facilitating the tasks to be performed by the bridge team and the pilot in making full appraisal of the situation and in navigating the ship safely under all operational conditions;

enabling the bridge team and the pilot to have convenient and continuous access to essential information that is presented in a clear and unambiguous manner, using standardized symbols and coding systems for controls and displays;

indicating the operational status of automated functions and integrated components, systems and/or sub-systems;

minimizing the risk of human error and detecting such error if it occurs through monitoring and alarm systems, in time for the bridge team and the pilot to take appropriate action.

The relative location of individual equipment and their placement in relation to the distance from the working position of the user are governed by:

type and range of equipment to be installed (refer to Guidance note of 3.3.2);

equipment relationship with tasks to be performed at the various workstations (refer to Guidance note of 2.1 and 3.3.1);

importance of equipment functions and frequency of use (refer to 2.1);

workstation and console configurations (refer to 2.7);

size of equipment and space available for installation (case by case).

**3.3.2** All information, controls, facilities and fields of vision required to carry out each of the tasks safely and efficiently shall be provided at the corresponding workstations.

**Guidance note.**

The table specifies minimum carriage requirements for ships of different tonnage, the tasks or the purpose the equipment shall serve and the type of workstation (WS), at which the equipment shall be used and shall be installed. Refer also to table 2.1.1 specifying equipment in relation to functions and tasks.

Workstation for navigating and maneuvering.

**3.3.2.1** Installation of voyage data recorder (VDR).

To assist in casualty investigations, ships, when engaged on international voyages shall be fitted with a voyage data recorder (VDR).

**3.3.3** Other means than those specified in 3.3.1 may be permitted, provided they serve the same functions and are approved.

**3.3.4** The location of equipment at the workplaces for navigation, maneuvering, traffic surveillance and monitoring shall enable:

easy use of all controls, switches and buttons from standing position;

easy use of primary means for route monitoring;

traffic surveillance;

heading and speed adjustments;

internal and external communication, including ship's whistle;  
change of steering mode, from seated position.

Work in paper charts and maneuvering requiring the use of lateral thrusters may be performed in standing position only, but controls for thruster systems shall be grouped with controls for propulsion and manual steering.

**Guidance note.**

The position for operation of radars and the position at the centre console for harbor maneuvers are regarded the main working positions at the workstation for navigation and maneuvering. Figure 3.3.4 indicates location of main categories of equipment that shall be within reach from the front workstation comprising three workplaces. Examples of location of primary equipment are shown in Annex 2.

Table 3.3.2

<b>Workstation for navigating and manoeuvring</b>				
Main functions: Position surveillance, traffic surveillance, course alterations and speed changes				
<b>Equipment and means</b>				
<i>Task/Purpose</i>	<i>Equipment</i>	<i>Indicators</i>	<i>Related equipm.</i>	<i>Remarks</i>
<i>Other means</i>				
<b>Applicable for all ships</b>				
Check heading	Magnetic compass <sup>1</sup>			<sup>1</sup> Readable from WS for manual steering
Take optical bearings	Pelorus Means of correcting heading and bearing to true		Magnetic compass	Arc of 360°
Positioning - manual - electronic <sup>1</sup>	GNSS Paper charts Chart table ECDIS w/backup arr. <sup>1</sup>			<sup>1</sup> Optional chart system
Surveillance by hearing	Sound reception system	Sound direction		All ships w/ totally enclosed bridge

Table 3.3.2 — continued

Workstation for navigating and manoeuvring				
Communicate heading <sup>1</sup> - manual - automatic <sup>2</sup>	Telephone		<sup>2</sup> Main gyro (optional)	<sup>1</sup> To emergency steering position <sup>2</sup> Optional Gyro repeater (located in steering gear comp.)
<b>Applicable for ships ≥ 150gr.t</b>				
Spare compass	Interchangeable magnetic compass (or other means)			Stored in bridge area Gyro compass also connected to emergency source of electrical power may be accepted.
Communicate ship/shore	Signalling lamp			Readily available
<b>Applicable for ships ≥ 300gr.t.</b>				
Traffic surveillance Navigation	Radar with electronic plotting aid (EPA)			9 GHz
Check keel clearance	Echo sounding device			
Check speed & distance	Speed & distance measuring device			Speed through the water
Transmitting heading <sup>1</sup>	Transmitting heading device <sup>2</sup>			<sup>1</sup> Trans. to Radar/EPA and AIS <sup>2</sup> Gyro required for ships > 500 gr.t.
Ship identification, tracking	AIS			
External communication	VHF telephone			
<b>Applicable for ships ≥ 500gr.t.</b>				
Determine heading Transmitting heading <sup>2</sup>	Gyro compass	Gyro heading repeater		<sup>1</sup> Also available to WS for monitoring <sup>2</sup> Trans. to Radar/ATA and AIS
Take bearings – arc 360°		2 gyro bearing repeaters <sup>1</sup>	Main gyro	<sup>1</sup> Location bridge wings
Supply heading info to emergency steering pos.		Gyro heading repeater <sup>1</sup>	Main gyro	<sup>1</sup> Located at emerg. steering position
Manoeuvring - rudder angle  - RPM  - thruster force + direction - operational mode		Rudder angle  RPM/(Pitch)  Thruster settings  Actual mode of use		Readable also from WSs for monitoring + manual steering  Readable also from WS for monitoring  When equipment offers diff. modes
Traffic surveillance	ATA <sup>1</sup>		Radar	<sup>1</sup> Replaces EPA
<b>Applicable for ships ≥ 3000gr.t</b>				
Traffic surveillance Navigation	Radar with ATA			3GHz or 9GHz (Add a second radar with ATA)
<b>Applicable for ships &gt; 10000gr.t.</b>				
Traffic surveillance	Automatic radar plotting aid (ARPA) <sup>1</sup>		Radar	<sup>1</sup> Replaces one ATA
Automatic steering	Heading or track control system			
<b>Applicable for ships ≥ 50000gr.t.</b>				
Monitor ship's turn		Rate-of-turn		To be read from WS for monitoring + manual steering
Measure speed & dist. forward + athwartship	2-axis speed log			Over ground

Table 3.3.2 — continued

Workstation for navigating and manoeuvring				
Internal com.	Auto telephone.			
External com.	VHF telephone			
Monitor alarms and warnings	Alarm panel			Enabling accept of alarms and warnings
Accept watch alarms	Alarm accept button			Watch monitoring

Workstation for monitoring				
Main functions: Observation of bridge operations and surrounding environment – Assisting OOW				
Equipment and means				
Task/Purpose	Equipment	Indicators	Related equip.	Remarks
Monitor Steering		Gyro repeater Rudder angle Rate-of-turn	Main gyro	See WS for navigation and manoeuvring
Monitor Speed		Speed RPM main engine	Speed log	See WS for nav./man. Pitch if relevant
Monitor time		Clock		
Give sound signals	Whistle control			
Accept watch alarms	Alarm accept button			Watch monitoring
Internal com.	Telephone			
External com.	VHF telephone			
Monitoring environment	Ctrls. for window wipers, washing & heating Binoculars			

Workstation for Manual steering				
Main functions: Steering in accordance with compass heading and visual marks				
Equipment and means				
Task/Purpose	Equipment	Indicators	Related equip.	Remarks
Operating steering device	Wheel - tiller			
Monitoring compass heading		Compass heading Gyro repeater	Magnetic compass Main gyro	
Communicate bridge wings	Hands free talk-back telephone			

Workstation for Docking				
Main functions: Conning, course alterations, speed changes, mooring operations				
Equipment and means				
Task/Purpose	Equipment	Indicators	Related equip.	Remarks
Determine manoeuvring - Heading - Speed - Steering - Propulsion		Gyro repeater Speed Rudder angle RPM Pitch if relevant	Main gyro Speed log	
Manoeuvring operations	Main engine control <sup>1</sup>			If installed
	Steering control <sup>1</sup>			
	Thruster control <sup>1</sup>			
Monitor external conditions		Wind speed & direction *		* Optional installation
Communicate wheelhouse	Handsfree talk-back telephone			
Communicate tugs/pilot	VHF (point)			

Table 3.3.2 — continued

<b>Workstation for Docking</b>				
Main functions: Conning, course alterations, speed changes, mooring operations				
<b>Equipment and means</b>				
<i>Task/Purpose</i>	<i>Equipment</i>	<i>Indicators</i>	<i>Related equip.</i>	<i>Remarks</i>
boats				

<b>Workstation for planning and documentation</b>				
Main functions: Route planning – documenting ship operations				
<b>Equipment and means</b>				
<i>Task/Purpose</i>	<i>Equipment</i>	<i>Indicators</i>	<i>Related equip.</i>	<i>Remarks</i>
Route planning	GNSS Paper chart Chart table			
	Electronic chart			Optional

<b>Workstation for Safety operations</b>				
Main functions: Monitor safety state - Execute relevant measures - Organise operations				
<b>Equipment and means</b>				
<i>Task/Purpose</i>	<i>Equipment</i>	<i>Indicators</i>	<i>Related equip.</i>	<i>Remarks</i>
Display alarm conditions		Remaining alarm indicators not available at WS for navigation/man.		Include acknowledgement of fire and emergency alarms
Provide information + other means for safety management	Remaining safety controls not available at WS for nav./man. Internal telephone			Info about ship's safety systems and contingency plan to be available at the WS

<b>Workstation for Radio communication</b>				
Main functions: GMDSS – <i>Public correspondence</i>				
<b>Equipment and means</b>				
<i>Task/Purpose</i>	<i>Equipment</i>	<i>Indicators</i>	<i>Related equip.</i>	<i>Remarks</i>
GMDSS	To be specified in relation to trading area			
Public correspondence				

<b>Conning station (pilot)</b>				
Main functions: External and internal observations for determination of safe course and speed				
<b>Equipment and means</b>				
<i>Task/Purpose</i>	<i>Equipment</i>	<i>Indicators</i>	<i>Related equip.</i>	<i>Remarks</i>
Observe waters, navigational aids and traffic	Binoculars			Access to radar
Observe own ship's heading and steering, speed and propulsion		Gyro repeater Rudder angle Speed RPM/Pitch if relevant		
Effect sound signals	Whistle button			
Communicate other ships	VHF telephone			Easy access from working position

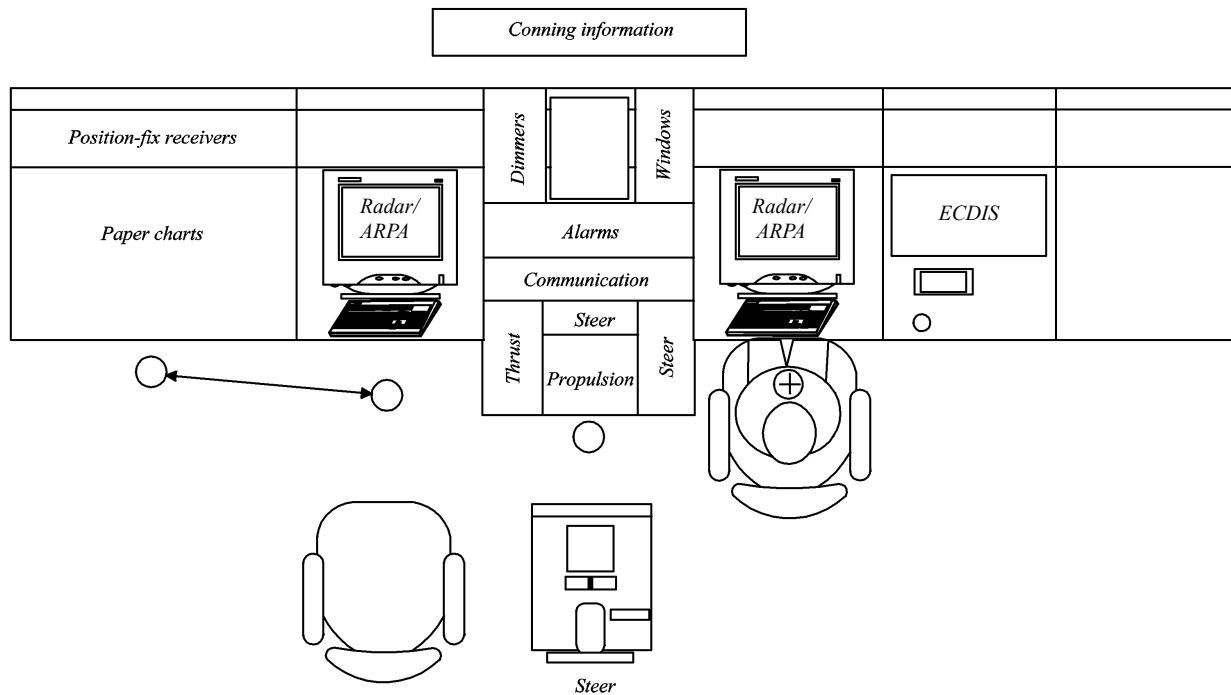

Fig. 3.3.4 Example of principle location of main equipment in a center console, which includes manoeuvring functions

## 4 BRIDGE PROCEDURES

### 4.1 BRIDGE TEAM MANAGEMENT

**4.1.1** Navigation bridges complying with this standard have been designed and arranged with the aim of:

- facilitating the tasks to be performed by the bridge team and the pilot in making full appraisal of the situation and in navigating the ship safely under all operational conditions;
- promoting effective and safe bridge resource management.

**4.1.2** Procedures shall be established enabling safe operations under all operational conditions by the manning required to master situations that may appear. Such procedures shall be defined in the company and ship specific bridge procedures manual and shall take account of the requirements of the ISM and STCW Codes and include manning requirements, responsibilities and training requirements for all normal and abnormal modes of operation.

**Guidance note.**

The bridge workstations are arranged to suit the distribution of functions and tasks at different operating conditions by manning the relevant workstations when required, as indicated in the table.

The workplace for traffic surveillance and maneuvering together with the workstation for safety operations and communication form an operational and emergency control centre wherefrom two persons can control the ship and handle emergency events in close cooperation.

Table 4.1.2

Examples of workstations in use during different operational conditions					
Operational conditions	Waters				
	Ocean areas Coastal water	Narrow waters	Pilot waters		Harbours
			General	Confined	
Normal	W1	W1+W2	W1+W2*	W1+(W3)+W8	W1+W3+W4
Irregular	W1+W2	W1+W2+W3	W1+W2*+W3	W1+W2+W3+W8	W1+W2+W3
Abnormal	W1+W2+W3	W1+W2+W3+W8	W1+W2+W3+W8	W1+W2+W3+W8	W1+W2+W3+W4
Emergency	W1+(W3)+W6+W7	W1+(W3)+W6+W7	W1+(W3)+W8+W6+W7	W1+(W3)+W8+W6+W7	W1+(W3)+W4+W6+W7

\*When used by the pilot  
 Symbols:  
 WS = workstation  
 W1 : WS for navigating, manoeuvring (+ traffic surveillance)  
 W2 : WS for monitoring/conning  
 W3 : WS for manual steering  
 W4 : WS for docking  
 W5 : WS for planning  
 W6 : WS for safety operations  
 W7 : WS for communication  
 W8 : conning station.

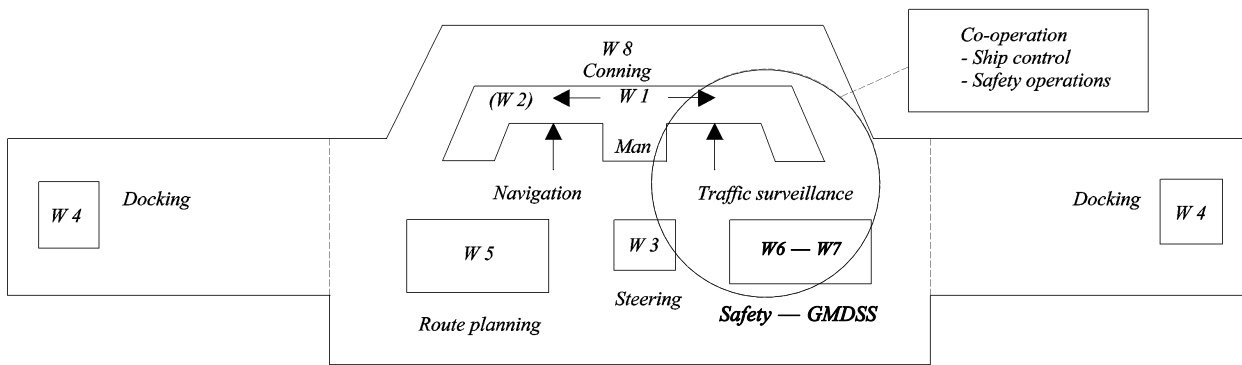

Fig. 4.1.2 Design principles — Location of workstations  
 Enabling efficient bridge team management during different operating conditions

## 4.2 OTHER BRIDGE PROCEDURES

- 4.2.1 The following routines shall be included and emphasized in the regular bridge procedures:
- use of heading and/or track control systems;
  - testing of manual steering system after prolonged use of automatic steering system;
  - operation of steering gear;
  - updating of nautical charts and nautical publications;
  - recording of navigational activities.



## **ANALYSIS AND DETAILS OF THE AIMS OF BRIDGE DESIGN AND EQUIPMENT ARRANGEMENT**

### **INTRODUCTION**

The present Annex contains the details and analysis of aims of the bridge design and equipment arrangement with respect to SOLAS regulation V/15 and its interface with other documents and applicable SOLAS regulations V/19, V/22, V/24, V/25, V/27, V/28), which ensures the achievement of a common understanding of the requirements and approach to their realization.

#### **AIM 15.1**

Facilitating the tasks (.1) to be performed by the bridge team and the pilot (.2) in making full appraisal of the situation and in navigating the ship safely under all operational conditions (.3).

##### **.1 Overall tasks to be performed:**

- route planning;
- navigation;
- traffic surveillance;
- maneuvering;
- docking;
- manual steering;
- conning;
- safety operations;
- internal and external communication related to the tasks to be performed;
- pilotage.

**.2 Basic tasks performed by the bridge team (based on minimum equipment carriage requirements and regular manning):**

- watch officer:
  - navigation — position-fixing by:
    - optical system;
    - radar system;
    - reading from display;
    - plotting ship's position;
    - visual observations;
    - adjust ship's heading to follow route;
  - traffic surveillance;
  - visual look-out;
  - monitor radar/ARPA;
  - maneuvering;
  - adjust ship's heading and speed in relation to traffic;
  - external and internal communication related to safety in bridge operation;
- rating, assisting the watch officer:
  - visual look-out;
- navigator, assisting the watch officer (or watch officer assisting the captain):
  - navigation — route monitoring;
  - position-fixing;
  - plotting ship's position;
  - adjust course;
  - monitor the waters;

rating, relieving the automatic heading control:

manual steering;

pilot assisting in safe navigation:

conning and determination of heading and speed.

**.3** Operational conditions and situations:

normal condition:

when all shipboard systems and equipment related to primary bridge functions operate within design limits, and weather conditions or traffic do not cause excessive operator workloads;

irregular condition:

when external conditions cause excessive operator workloads requiring professional assistance on the bridge;

abnormal condition:

when internal technical system failures require operation of basic back-up systems or when they occur during an irregular operating condition, or when the officer of the watch becomes unfit to perform his duties and has not yet been replaced by another qualified officer;

emergency situation:

when failure of internal ship systems not affecting the ability of navigation or maneuvering, or fire incidents occur, which need to be controlled and managed from the bridge;

distress situations:

when the ship has lost its navigating or maneuvering capability.

**.3.1** Example of bridge team composition under different operational conditions.

Reference, which may be used for design purposes\*:

normal: watch officer — night: + rating;

irregular: watch officer + assisting navigator (+ rating);

abnormal: captain + watch officer + look-out (+ helmsman);

emergency: captain + watch officer + assisting navigator + look-out (+ helmsman) (+ chief engineer/ chief officer).

\*A pilot may be included in any of the above manning examples.

### **AIM 15.2**

Promoting effective and safe bridge resource management (.1).

**.1** Factors promoting safe resource management:

organized distribution of tasks and responsibilities;

functional workplace arrangement suiting different operating conditions, task;

distribution and task performance;

procedures for safe operations.

### **AIM 15.3**

Enabling the bridge team and the pilot to have convenient and continuous access to essential information (.1), which is presented in a clear and unambiguous manner, using standardized symbols and coding systems for controls and displays (.2).

**.1** Essential information (and controls) required by the bridge team.

The information and controls required as well as what is to be regarded essential are linked to the type and importance of tasks to be carried out by the individual members of the bridge team and the pilot.

The table showing task and means, which is included in 2.1, identifies the essential information required. Easy access to information may be provided by outfitting and placing the workstations for efficient task performance by members of the bridge team, in accordance with the content of 3.3.

**.2** Presentation of information and standardization.

Requirements addressing presentation of information and coding of systems for controls and displays for equipment required to be carried are regulated by IMO performance standards and IEC test standards.

### **AIM 15.4**

Indicating the operational status (.4) of automated functions (.1) and integrated components (.2), systems and/or sub-systems (.3).

**.1** Relevant automated functions:

steering a set course;  
plotting ship's position in an electronic chart system;  
steering along a planned route governed by ship's position;  
adjusting the speed according to ship's position and preset values;  
maneuvering operations (semi-automatic/joystick).

**.2** Relevant integrated components:

heading control unit;  
satellite positioning-fixing unit (GNSS and GPS);  
electronic chart display unit (ECDIS);  
radar display unit;  
track control unit;  
speed control unit.

**.3** Relevant systems:

track control system;  
integrated navigation systems (INS), including grounding avoidance system for automatic route-keeping.

**.4** Indicating the operational status (of automated functions and integrated components, systems and/or sub-systems).

Indication of operational status is provided by:

supplying continuous information of relevant system activities related to the ship's course, speed, propulsion, steering and operating mode on one individual display;  
enabling continuous visual observation of key values;  
enabling the checking of the functioning of system elements and operational performance;  
enabling early detection of deviations from planned operations and system specifications.

Categories of indications that may be included:

normal operations:

available components in the total system configuration;  
configuration in use;  
activity status of individual components in use;  
second mode of operation at system failure, preferably based on system failure;  
mode, effect and criticality analysis (FMEAC);

early warning:

reduced accuracy;  
reduced reliability of integrated system performance;  
reduced reliability of propulsion and steering system;

alarm conditions:

equipment malfunction;  
system failure;  
display freeze;

operational warnings:

danger of collision;  
danger of grounding;  
weather conditions.

**AIM 15.5**

Allowing for expeditious, continuous and effective information processing and decision-making (.1) by the bridge team and the pilot.

**.1** Conditions allowing effective information processing and decision-making:

when all information required for evaluation and decision-making is clearly presented and available at the location where action shall be taken on the decision made, including appropriate feedback on actions and updated information for continuous consideration;

when information and equipment for performance of functions to be carried out by different members of the bridge team are arranged at specific workstations located for close co-operation.

**AIM 15.6**

Preventing or minimizing excessive or unnecessary work and any conditions or distractions on the bridge, which may cause fatigue or interfere with the vigilance of the bridge team and the pilot (.1).

**.1** Conditions that may interfere with the vigilance of the bridge team.

Such conditions include:

- poor working environment;
- location of workstations for additional functions too close to navigation area;
- location of information needed for decision-making, which is wide spread;
- lack of harmonization of workplace functionality;
- unauthorized persons on the navigation bridge;
- high workloads.

**AIM 15.7**

Minimizing the risk of human error and detecting such error if it occurs (.1), through monitoring and alarm systems (.2) , in time for the bridge team and the pilot to take appropriate action (.3).

**.1** Factors imperative for minimizing human error.

Workplace related:

- workplace functionality;
- information availability;
- system reliability;
- human-machine interface;
- system architecture of automation systems based on fail-to-safe philosophy with simple and reliable second mode of operations.

Human related:

- competence;
- attitude;
- complacency.

Operational:

- manning;
- working routines;
- bridge team management.

Detectable during operations:

- inappropriate performance.

**.2** Monitoring and alarm systems.

Systems and methods enabling detection of human error and timely warning for appropriate action include:

monitoring and alarm transfer systems, monitoring personal activity and lack of response on operational warnings and alarm conditions related to safety of navigation and the ship's safety systems, and transferring unacknowledged warnings and alarms to qualified person.

**.3** In time for appropriate action.

Conditions affecting the time for appropriate action:

Operational warnings:

- time to danger of collision and grounding (distance/speed);
- time to be allowed for required action.

Equipment and system failure alarms:

- failure mode and effect;
- size of navigating area.

## EXAMPLES OF ARRANGEMENT OF BRIDGE MAIN EQUIPMENT

Table of tasks and related means for safe operations

Tasks and Means - Location					
Function/Tasks to be performed	Equipment to be operated	L	Information to be viewed	L	Remarks
<i>Navigation</i> – <i>Grounding avoidance</i>					L = Reference for location in console
Planning					
Plan route prior to departure	Paper chart/table	N1			
Alter route while under way	Nautical publications		GPS Position		
	DGPS	N2			
	ECDIS*	N3			*Optional install.
	ECDIS backup**	N4			**If replacing paper
In Transit					
Monitor route-keeping: - Determine position by bearings - Read position on display - Plot position	Pelorus/gyro repeater* Radar DGPS Paper chart/table	N5 N6 N2 N1			*Analog. Bearings 360° around the horizon, (one on each bridge wing)
- Determine and plot position automatic	ECDIS	N3			Optional installation
Maintain route/alter course by - manual steering - using autopilot - automatic route-keeping	Manual steering ctrl Heading ctrl. system Track ctrl. system* (ECDIS)	M1 M2 M2A* NA2			*Alternative to head ctrl. Interfaced to ECDIS, gyro, speed, radar when part of INS
Give sound signals	Whistle ctrl.	C1			Fog - traffic
Receive sound signals	Sound reception syst.	C2	Loudspeakers		Enclosed bridge
Monitor/Take action: - operational warnings - system failure alarms - ship's safety state	Alarm panel Alarm systems	S1 S2			
Monitor heading, turn, rudder angle, speed, propulsion			Gyro repeater Indicators: - rudder angle - rate-of-turn - RPM, Pitch - speed log	IM1 IM2 IM3 IM4 M5	
Adjust lighting	Dimmer buttons	L1			
Monitor shallow water areas	Echo Sounder system	N10	Water depth	IN1	(Anchoring)
Monitor performance automatic route-keeping system			Conning info display	IA3	Organizing indicator info providing situation awareness when in automatic route-keeping mode
Effect internal communication	Intercom (auto tlph.)	C3			
Effect external comm.	VHF	C4			Related to nav.
Receive/send distress message	GMDSS remote ctrl.	C5			
<i>Traffic surveillance</i> – <i>Collision avoidance</i>		T			
Detect floating targets Analyse traffic situations Observe visually	Radar with ETP* (may incl. AIS) Binoculars Window wiper -cleaning - heating ctrl.	T1	Targets relative position, course, speed Expected passing distance Time		*Electronic target plotting ("historical" data)
Decide on collision avoidance measures	AIS (automatic identification system)	T2	Target true position, course, speed		Regarded additional info (means)
Manoeuvring		M			(For route-keeping)

Rules for the Equipment of Sea-Going Ships

V-190

Change steering mode	Steering mode switch	M0			
Alter heading	Heading ctrl.	M2	Heading (Gyro)	IM1	
Observe rudder angle			Rudder angle	IM2	
Override steering	Override ctrl.	M4			
Manual steering ctrl.		M1			
Change speed	Propulsion ctrl.	M3	RPM/Pitch	IM4	
Give sound signals	Whistle ctrl.	C1			
Receive sound signals	Sound reception syst.	C5	Loudspeaker	IC5	Enclosed bridges
Navigate back to route	Paper chart/table DGPS	N1 N2			
Maintain track of traffic	Radar with route and navigable waters	T1			
	ECDIS*	N3			*May replace paper
Harbour manoeuvring	Thruster	M5			Owners specification
<b>Anchoring</b>					
Manoeuvre	Manual steering ctr. Propulsion ctr. (Thruster ctrl.)	M1 M3 M5	Heading Rudder angle RPM/Pitch	IM1 IM2 IM4	Performed at front workstations or in combination with docking station. Information to be provided for Pilots.
Positioning (Identify anchor position)	Radar Chart DGPS	T1 N1 N2	Water depth	IM6	
Observe ship's safety state					
Monitor alarm conditions: - Navigation alarms Equip. & system failures Operational warnings	Main alarm panel W/indicators and acceptance button		Alarm list		
- Machinery alarms	Alarm panel				
- Cargo alarms	Alarm panel				
- Fire alarm	Fire alarm panel				

<i>Conning station</i>					
Determine & direct course and speed in relation to waters and traffic					
Monitor:					
- heading			Gyro repeater	IM1	Digital, readable 2 m
- rudder angle			Rudder angle	IM2	
- rate-of-turn			RoT indicator	IM3	
- propulsion			RPM/Pitch	IM4	
- speed			Speed log	IM5	
- water depth			Echo sounder display	IM6	Anchoring
Give sound signals	Whistle ctrl. button				
Effect communication	VHF				Available

<i>Manual steering</i>					
Maintain, adjust, alter heading according to order	Steering ctrl. Intercom (Public address system)	M6 C6	Gyro repeater Magn. comp. Rudder angle Rate-of-turn		(Rating)

<i>Safety operations</i>					
Take action on alarm condition: - analyse situation - consult plans and drawings	Manuals - Drawings		Computer based info		
- observe ship's external operational situation					Cooperation with navigating officer
- organize and execute measures by communication - check status of ventilation	Intercom (UHF) Emergency stop				

*Rules for the Equipment of Sea-Going Ships*

V-191

system					
Monitor development of alarm conditions					
- Cargo alarms	Alarm panel				
- Fire detection & alarms	Fire detection and alarm panel				
- Gas & smoke detection					

<i>External communication</i>					
Distress - weather - safety	GMDSS station	C7			As required (Area)
Determine weather conditions Consider nav. warnings	Navtex receiver	C8			
Public correspondence	Additional equipment				Specified by owners

<i>Docking operations (bridge wings)</i>					
Directing steering	Intercom (Public address system)	C6	Heading Rudder angle	IM1 IM3	
Directing speed	Intercom (Public address system)	C6	RPM/Pitch	IM5	
Giving sound signals	Whistle control button	C1			
Receiving sound signals	Sound reception syst.	C2	Loudspeaker	IC2	Enclosed bridge
Perform manoeuvring	Steering Prop. ctrls Thruster ctrl.	M1 M3 M4			Additional install. by owners
<i>Additional functions</i>					Refer to 2.2

Symbols used in column "L" of the Table:  
 N = equipment for navigation;  
 A = indicating extended automation of function;  
 I = information — indicators/displays for navigation;  
 T = equipment for traffic surveillance;  
 C = communication means;  
 M = means required for manoeuvring functions.

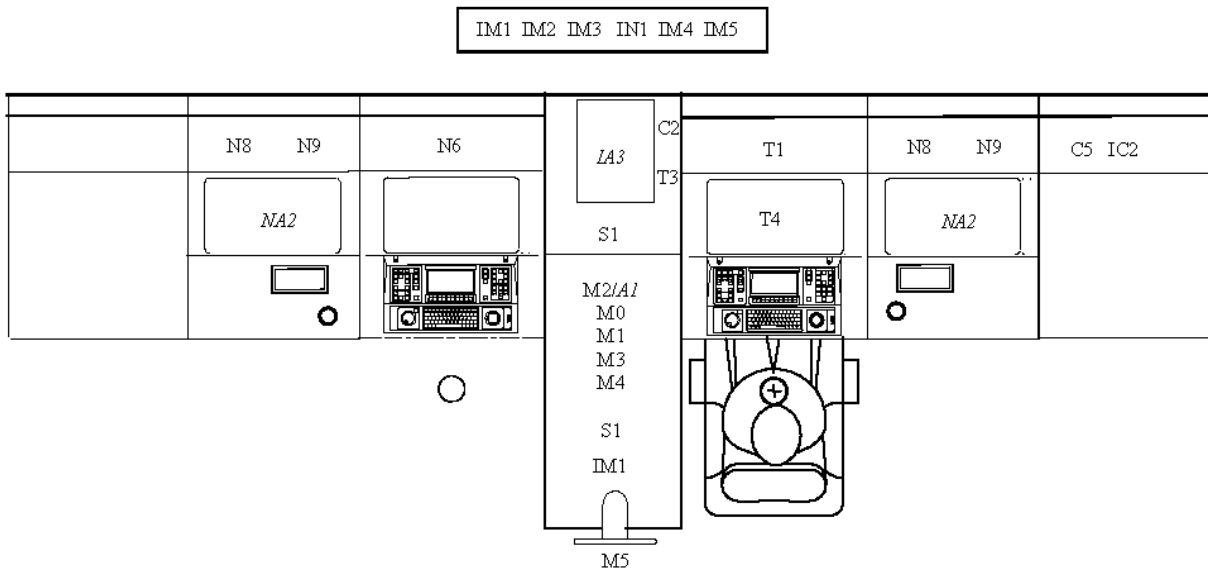

Individual workplaces

Example of location of main equipment in a centre console.  
Easy access to maneuvering functions in standing position (refer to 3.3.3)

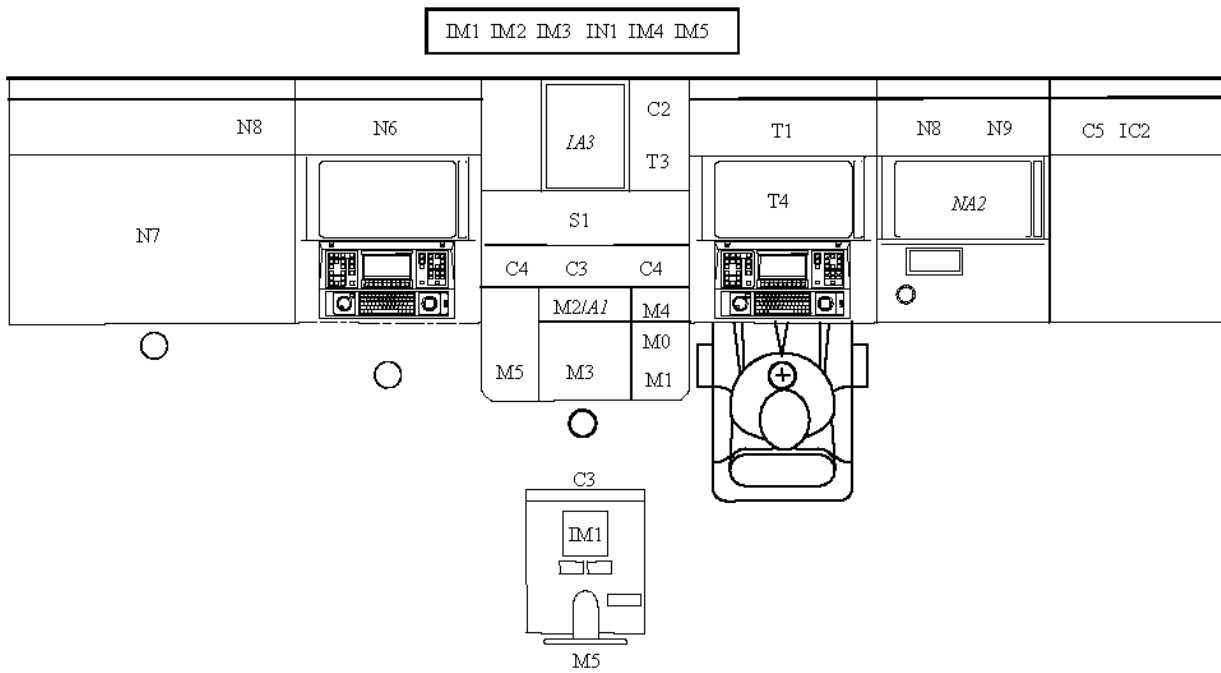

Redundant workstations

When all the means required for performance of navigation, traffic surveillance and maneuvering are available at each of the two workplaces, a long centre console dividing the workstation may be used



**RECOMMENDATIONS ON INSTALLATION OF MAGNETIC COMPASSES**

1. Magnetic compasses are recommended to be so installed that the distances between the compass bowl centre and magnetic materials of the ship structures are at least equal to the values specified in Tables 1-1 and 1-2.

Table 1-1

**Least distances between the magnetic compass and the ship's metal structures manufactured of magnetic materials depending on the ship length**

Distance from immobile materials, in m								Distance from mobile magnetic materials with changeable magnetic field, in m									
Ship's extreme length, in m																	
Not more than 30	40	50	60	70	80	83 and over	Not more than 30	40	50	60	70	80	90	100	110	120 and over	
1,5	1,75	2,1	2,3	2,7	2,9	3,0	2,0	2,2	2,4	2,6	2,9	3,1	3,4	3,5	3,7	4,0	
Notes: 1. Mobile materials mean boat davits, ventilator pipes, doors, cargo booms and other mobile ship structures manufactured of magnetic materials. 2. Materials with changeable magnetic field mean exhaust pipes, funnels and other heating appliances manufactured of magnetic materials. Casings of funnels are considered immobile magnetic material.																	

Table 2

**Least distances between the magnetic compass and the ship's metal structures manufactured of magnetic materials for fishing vessels and vessels of restricted navigation area with extreme length up to 60 m**

Distance from magnetic materials, in m, depending on the ship's extreme length, in m				
Not more than 20	30	40	50	60
1,1	1,3	1,5	1,7	2,0

2. All metal magnetic materials shall be arranged, if possible, symmetrically relative to the magnetic compass.

3. Distance between the magnetic compass bowl and the deck or ceiling made of magnetic materials shall not be less than 1 m, while distances from bulkheads ends and metal deck cartings in this case shall be at least as those indicated in Table 1-1.

4. Magnetic compasses shall be installed at a distance not less than 2 m from each other. For ships of less than 60 m in length, this distance may be reduced to 1,8 m.

**RECOMMENDATIONS ON DETERMINING "SAFE DISTANCE"  
FOR MAGNETIC COMPASS**

1. All navigational equipment shall be provided with inscriptions indicating the least distance at which this equipment may be installed from the magnetic compass.

This least distance is considered "safe distance" unless the magnetic fields of the equipment cause disturbances in magnetic compass readings more than  $0,045^\circ/H$  where  $H$  is a horizontal constituent of the magnetic field of the Earth, O (oersted).

2. The "safe distance" shall be determined for every kind of the equipment by means of the following three methods:

.1 measurement the distance between the nearest point of the equipment and the magnetic compass centre when the magnetic compass card inclination resulting under magnetic field influence caused by the equipment is equal to the value to be determined in relation of the stated above. The equipment shall be as it is normally installed on board ship;

.2 distance measured after magnetization of the equipment in field intensity as much as 1,5 O caused by direct current and by additional superimposition of stabilizing field of alternating current with intensity 18 O (average quadrature value). In some cases super-imposition of alternating magnetic field is not permitted as it may result in damage of the equipment.

Magnetization of the equipment shall be made so as to receive the greatest result (for example, along the longest axis of the equipment made of a magnetic material);

.3 distance measured, as specified in 2.1, from the equipment which is power supplied and which is in the working condition.

3. The greatest distance which is received as a result of comparison of the three above stated measurements shall be assumed as "safe distance".

4. "Safe distances" stated in the Recommendations refer to the equipment installed near the magnetic compass on ships of unrestricted navigation area.

5. As to compasses of ships of restricted navigation area of less than 60 m in length "safe distances" may be 25 % less.

## **INSTALLATION OF ELECTRICAL AND ELECTRONIC EQUIPMENT ON THE BRIDGE AND IN THE VICINITY OF THE BRIDGE**

**1.** All electrical and electronic equipment intended to be operated on the bridge or in the vicinity of the bridge, on ships constructed on or after 1 July 2002, shall be tested for electromagnetic compatibility (EMC).

**2.** It shall be ascertained that the electromagnetic interference created by the equipment operated on the bridge or in the vicinity of the bridge does not affect the proper function of navigational equipment and systems.

**3.** Portable electric and electronic equipment shall not be operated on the bridge if it may affect the proper function of navigational equipment and systems.

**4.** All the radio and navigational equipment to be fitted on a ship in accordance with the Rules for the Equipment shall be of a type approved by the Register (type approval of products includes the necessary EMC tests).

**5.** All other installed and portable electric and electronic equipment other than mandatory radio and navigational equipment shall be EMC tested (at least tests for Conducted and Radiated Emission shall be conducted).

**6.** The definition "bridge and vicinity of the bridge" covers the following zones:  
the wheelhouse including bridge wings;  
control rooms in way of bridge intended for installation of radio and navigational equipment, alarm systems, inter-communication systems, signal processing and auxiliary equipment;  
areas in close proximity (not more than 5 m) to receiving and/or transmitting antennas and large openings in the metallic structure of ship's superstructure or deckhouse (windows, doors, closing appliances). Equipment beyond 5 m from the above openings need not be considered for the purpose of these requirements.

**7.** For the purpose of these requirements, equipment need to be tested for conducted and radiated emission only.

Test standards are specified in 5.1.16, Part V "Navigational Equipment" of the Rules for the Equipment.

The results of tests conducted in accordance with standards other than specified in 5.1.16, Part V "Navigational Equipment" of the Rules for the Equipment may be considered and taken into account. In this case, particular attention shall be paid to the level of radiated emission in the frequency band from 156 — 165 MHz and the location of the equipment.

**8.** Passive-EM equipment (refer to 9,10) need not be EMC tested but it shall be supplied with a manufacturer's statement confirming that the equipment is passive-EM equipment.

**9.** Equipment is considered a passive-EM equipment if, when used as intended, without internal protection measures such as filtering or shielding, and without any user intervention, it does not create or produce any switching or oscillation of current/voltage and is not affected by electromagnetic disturbances.

**10.** Passive-EM equipment covers all equipment which includes no active electronic part, in particular:  
cables and cabling systems, cables accessories;  
equipment containing only resistive loads without any automatic switching device (e.g. simple domestic heaters with no controls, thermostat, or fan);  
batteries and accumulators, etc.

**11.** All electrical and electronic equipment operated on the bridge and in the vicinity of the bridge shall be listed.

The list of electrical and electronic equipment intended to be operated on the bridge or in the vicinity of the bridge shall contain at least the following information:

equipment description;

name of manufacturer;

type;

evidence of EMC which may be: Type Approval Certificate,

reports on tests for conducted and radiated emission having been conducted at a testing laboratory accredited by the Register,

reports on EMC tests conducted on the navigation bridge of a newbuilding by a testing laboratory accredited by the Register for these purposes,

manufacturer's statement (for passive-EM equipment).

**12.** List of electrical and electronic equipment operated on the bridge and in the vicinity of the bridge and evidence of EMC compatibility shall be kept on board at all times.

## RECOMMENDATIONS ON THE INSTALLATION OF A SHIPBORNE AUTOMATIC IDENTIFICATION SYSTEM (AIS)

### 1 GENERAL

**1.1** Technical and operational requirements for AIS are set out in 5.18, Part V "Navigational Equipment" of the Rules for the Equipment.

Installation of the AIS may be performed by the equipment manufacturer's technicians or firms recognized by the Register as capable of carrying out this type of work. Installation of AIS by ship's crew or by organizations having no recognition is not allowed.

### 2 AIS INSTALLATION

#### **2.1 Interference to the ship's vhf radiotelephone station.**

**2.1.1** The AIS shipborne equipment, like any other shipborne transceiver operating in the VHF maritime band, may cause interference to a ship's VHF radio-telephone station. Because AIS is a digital system, this interference in the VHF radiotelephone station may occur as a periodic (e.g. every 20 s) soft clicking sound on a ship's radiotelephone. This effect may become more noticeable when the VHF radiotelephone station antenna is located near the AIS VHF antenna and when the VHF radiotelephone station is operating on channels near the AIS operating channels (e.g. channels 27, 28 and 86).

Attention shall be paid to the location and installation of different antennas in order to obtain the best possible efficiency of the AIS operation, and special attention shall be paid to the installation of AIS VHF antennas.

#### **2.2 AIS VHF antenna installation.**

##### **2.2.1** Location.

**2.2.1.1** Location of the AIS VHF antenna shall be carefully considered. Digital communication is more sensitive than analogue/voice communication to interference created by reflections in obstructions like masts and booms. In some instances, based on the results of sea trials, it may be necessary to relocate the VHF radiotelephone station antenna to minimize interference effects.

To minimize interference effects, the following guidelines apply:

The AIS VHF antenna shall have omnidirectional vertical polarisation;

The AIS VHF antenna shall be placed in an elevated position that is as free as possible with a minimum of 2 m in horizontal direction from constructions made of conductive materials. The antenna shall not be installed close to any large vertical obstruction. The objective for the AIS VHF antenna shall see the horizon freely through 360°;

The AIS VHF antenna shall be installed safely away from interfering high-power energy sources like radar and other transmitting radio antennas, preferably at least 3 m away from and out of the transmitting beam.

There shall not be more than one antenna on the same level. The AIS VHF antenna shall be mounted directly above or below the ship's primary VHF radiotelephone station antenna, with a minimum of 2 m vertical separation. If the AIS VHF antenna is located on the same level as other antennas, it is desirable that the distance apart shall be at least 10 m.

##### **2.2.2** Cabling.

**2.2.2.1** The cables shall be kept as short as possible to minimize attenuation of the signal. Double screened coaxial cables equal or better than RG214 are recommended.

All outdoor installed connectors on the coaxial cables shall be waterproof by design to protect against water penetration into the antenna cable.

Coaxial cables shall be installed in separate signal cable channels/tubes and at least 10 cm away from power supply cables. Crossing of cables shall be done at right angles (90°). Coaxial cables shall not be exposed to sharp bends, which may lead to change the characteristic impedance of the cable. The minimum bend radius of a coaxial cable shall be 5 times the cable's outside diameter.

### **2.2.3 Grounding.**

**2.2.3.1** Coaxial down-leads shall be used for all antennas, and the coaxial screen shall be connected to ground at one end.

### **2.3 Global navigation satellite system antenna installation.**

**2.3.1** AIS shall be connected to a Global Navigation Satellite System (GNSS) antenna.

#### **2.3.1.1 Location.**

**2.3.1.1.1** The GNSS antenna shall be installed where it has a clear view of the sky and is not obstructed by ship's structures. The objective shall see the horizon freely through 360° with a vertical observation of 5 to 90° above the horizon. Small diameter obstructions, such as masts and booms, do not seriously degrade signal reception, but such objects shall not eclipse more than a few degrees of any given bearing.

The antenna shall be located at least three meters away from and out of the transmitting beam of high-power transmitters (radars and/or INMARSAT ship earth stations). This includes the ship's own AIS VHF antenna.

If a DGNSS system is included or connected to the AIS system, the installation of the DGNSS antenna shall be in accordance with manufacturer's recommendations.

#### **2.3.2 Cabling.**

**2.3.2.1** To achieve optimum performance, the gain of the antenna pre-amplifier shall match the cable attenuation. The resulting installation gain determined as the difference between pre-amplifier gain and cable attenuation shall be within 0 to 10 dB.

The coaxial cable between the GNSS antenna and the AIS shipborne station connector shall be routed directly in order to reduce electromagnetic interference effects. The GNSS antenna cable shall not be installed close to high-power lines, such as radar or radio-transmitter cables or waveguides including the AIS VHF antenna cable. A separation of one meter or more is recommended between the above cables to avoid degradation due to RF-coupling. Crossing of antenna cables shall be done at 90° to minimize magnetic field coupling.

All outdoor installed connectors on the coaxial cables shall be waterproof by design to protect against water penetration into the antenna cable.

### **2.4 Power source.**

**2.4.1** The AIS shall receive power supply from the main and emergency sources of electrical power, for which purpose the AIS shall be connected to the navigational equipment switchboard.

### **2.5 Synchronization.**

**2.5.1** After installation, the AIS shall be synchronized properly on Universal Coordinated Time (UTC), and the position information, if provided, shall be correct and valid.

## **3 BRIDGE ARRANGEMENT**

### **3.1 Minimum keyboard and display.**

**3.1.1** A minimum keyboard and display (MKD) shall be installed at the position from which the ship is normally operated. This can be the AIS internal MKD (integrated or remote) or a separate display system.

### **3.2 Pilot plug.**

**3.2.1** A pilot input/output port is a mandatory part of the shipborne AIS equipment. A plug connected to this port shall be installed on the bridge near the pilot's operating position so that a pilot can connect a personal computer to AIS.

The pilot plug shall be configured as follows:

AMP/Receptacle (Square Flanged (-1) or Free-Hanging (-2)), Shell size 11, 9-pin, Std. Sex 206486-1/2 or equivalent with the following terminations:

TX A is connected to Pin 1;  
TX B is connected to Pin 4;  
RX A is connected to Pin 5;  
RX B is connected to Pin 6;  
Shield is connected to Pin 9.

### **3.3 AIS display system.**

**3.3.1** If there is navigational equipment capable of displaying AIS information (radar display, electronic chart display and information system (ECDIS) display or integrated navigation system) installed at the position from which the ship is normally operated, the AIS shall be connected to that equipment in accordance with the requirements of the international standard "Maritime Navigation and Radiocommunication Equipment and Systems — Digital Interfaces".

The additional display system can also include the functionality of an MKD (refer to 3.1.1).

### **3.4 Installation of the built-in integrity test (BIIT) function.**

**3.4.1** The AIS requires that an alarm output (relay) be connected to an audible alarm device or the ship's alarm system, if available.

In cases where audible alarm of AIS failure is provided by an audible device built into the minimum keyboard and display, connection to an external audible alarm device or the ship's alarm system is not needed.

Alternatively, the BIIT alarm system may use the alarm messages output on another compatible ship's alarm system.

## **4 DYNAMIC DATA INPUT**

### **4.1 External sensors**

**4.1.1** The AIS has interfaces for position, heading and rate of turn (ROT) sensors whose configuration complies with the requirements of the international standards "Maritime Navigation and Radiocommunication Equipment and Systems — Digital Interfaces" (IEC 61162-1 or 61162-2). Sensors installed in compliance with other carriage requirements of SOLAS-74, Chapter V shall be connected to the AIS<sup>1</sup>. The sensor information transmitted by AIS shall be the same information being used for navigation of the ship.

### **4.2 Ship's position, course over ground (cog) and speed over ground (SOG)**

**4.2.1** GNSS sensors (global navigation satellite system receivers) normally have standard outputs for position, COG and SOG suitable for directly interfacing the AIS. However, it is important to note that: the Geodetic Datum of the position data transmitted by the GNSS receiver is WGS 84 and that an IEC 61162 DTM sentence is configured;

AIS is able to process two reference points for GNSS antenna position, one for external and one for an internal GNSS sensor. If more than one external reference point is used, the appropriate information needs to be input to the AIS to adjust reference point information.

### **4.3 Heading**

**4.3.1** A compass (gyrocompass or magnetic compass) providing heading information is a mandatory sensor input to the AIS. Some ships of less than 500 gross tonnage may not carry a gyrocompass providing heading information. In such ships, heading information shall be provided to the AIS by a transmitting heading device.

---

<sup>1</sup>Installation of the AIS does not establish a need to install additional sensors above carriage requirements.

#### 4.4 Rate of turn

**4.4.1** The AIS provides the rate of turn (ROT) information to other ships in order to early detect ship's manoeuvres and their rate. The following parameters indicating turning of a ship (direction and rate of turn) can be derived from two different sensors:

the heading (from a gyrocompass or transmitting heading device);

the rotation rate itself (from a rate-of-turn indicator).

In accordance with the requirements of SOLAS-74 Chapter V and IMO resolution A.526(13), the rate-of-turn indicator need not be fitted on ships of less than 50,000 gross tonnage. However, if a rate-of-turn indicator is available and it includes an interface in accordance with the requirements of the international standard "Maritime Navigation and Radiocommunication Equipment and Systems — Digital Interfaces" (IEC 61162), it shall be connected to the AIS.

If a rate-of-turn indicator complying with the requirements of IMO resolution A.526(13) is connected to the AIS, the AIS shall use the information derived from this device to broadcast both direction and value of turn on the VDL.

If valid ROT or heading data is available from another external source (Integrated Navigation System), the AIS shall use this information to broadcast the direction of turn on the VDL, if greater than 5° in 30 s (might also be implemented as 2.5° in 15 s by configuration).

If no ROT information is available, the AIS shall transmit default values indicating "not available".

ROT data shall not be derived from COG information.

#### 4.5 Navigational status

**4.5.1** A simple means shall be provided for the operator to input the ship's navigational status (e.g. underway using engine; at anchor; not under command; restricted in ability to maneuver, etc.) information into the AIS. The AIS may be connected to the ship's navigational status lights.

## 5 STATIC INFORMATION

**5.1** In accordance with the technical and operational requirements for the AIS, certain static, dynamic and voyage-related information shall be entered manually, normally by means of the MKD, or by means of IEC 61162 sentences "SSD" and "VSD" via the presentation interface if such provisions exist.

#### 5.1 Entered at initial installation of AIS.

**5.1.1** Information that shall be entered at the initial installation of the AIS includes:

Maritime Mobile Service Identity (MMSI) number;

IMO ship number;

radio call sign;

name of ship;

type of ship;

dimension/reference for position of the GNSS antenna (refer to 5.2).

Access to "MMSI", "IMO number" and other AIS controls (like power and channel settings) shall be controlled (e.g. by password).

The "call sign", "name of ship" and "type of ship" shall be input to the AIS, either manually using the MKD or by means of IEC 61162 sentences "SSD" and "VSD" via the presentation interface. Type of ship information shall be in accordance with Table 5.1.1.

#### 5.2 Reference point for GNSS antenna position.

**5.2.1** The AIS stores one "external reference point" for the external GNSS antenna position and one "internal reference point" if an internal GNSS shall be used as fallback for position reporting. The locations of these reference points shall be set during installation of the AIS using values A, B, C, D; as described in 5.3.1.

The external reference point may also be a calculated common reference position.



### **5.3 Ship's dimensions.**

**5.3.1** Ship's dimensions shall be entered using the overall length and width of the ship indicated in Fig. 5.3.1 as  $(A + B)$  and  $(C + D)$ , respectively.

Ship's dimensions  $(A + B)$  and  $(C + D)$  shall be identical when entering internal and external reference points.

## **6 LONG-RANGE FUNCTION OF THE AIS**

**6.1 The AIS long-range function needs a compatible long-range communication system (e.g. INMARSAT-C or MF/HF radio installation).**

If this is available, a connection between that communication system and the AIS can be made. This connection is needed to activate the long-range function of the AIS and it shall meet the requirements of the international standard "Maritime Navigation and Radiocommunication Equipment and Systems — Digital Interfaces".

## **7 FORMALIZING THE AIS INSTALLATION RESULTS**

**7.1** After completion of installation and adjustment work, acceptance and sea trials shall be carried out where all the AIS equipment shall be checked in real operational conditions, including operability of signal converters, connected sensors and information users.

On completion of technical supervision of the AIS installation, Register surveyor shall draw up a report in form 6.3.10 specifying the information on the installation technical design approval, by whom, when and where the AIS was installed, the results of the acceptance and sea trials, and a conclusion regarding the possibility of further use of AIS on board the ship or remarks (if any).

In case of satisfactory results of trials witnessed by a Register representative, use of the AIS is allowed as part of shipborne navigational equipment required by SOLAS-74 Chapter V, and the AIS is included in ship's documents (Record of Equipment for the Cargo Ship Safety Equipment Certificate or the Passenger Ship Safety Certificate (forms E, P)).

Identifiers to be used by ships to report their type

Identifier No.	Types of ships		
Special craft			
50	Pilot vessels		
51	Search and rescue vessels		
52	Tugs		
53	Port tenders		
54	Vessels with anti-pollution facilities or equipment		
55	Law enforcement vessels		
56	Spare – for assignments to local vessels		
57	Spare – for assignments to local vessels		
58	Medical transports (as defined in the 1949 Geneva Convention and Additional Protocols)		
59	Ships according to Resolution No. 18 (Mob-83)		
Other ships			
First digit <sup>1</sup>	Second digit <sup>1</sup>	First digit <sup>1</sup>	Second digit <sup>1</sup>
1 — reserved for future use	<b>0 — all ships of this type</b>	—	0 — fishing
2 — wing-in-ground craft (WIG)	1 — carrying dangerous goods (DG), harmful substances (HS), or marine pollutants (MP) IMO hazard or pollutant category X <sup>2</sup>	—	1 — towing
3 — see right column	2 — carrying DG, HS, or MP IMO hazard or pollutant category Y <sup>2</sup>	3 — vessel	2 — towing and length of the tow exceeds 200 m or breadth exceeds 25 m
4 — high-speed craft (HSC)	3 — carrying DG, HS, or MP IMO hazard or pollutant category Z <sup>2</sup>	—	3 — engaged in dredging or underwater operations
5 — see above	4 — carrying DG, HS, or MP IMO hazard or pollutant category OS <sup>2</sup>	—	4 — engaged in diving operations
	5 — reserved for future use	—	5 — engaged in military operations
6 — passenger ships	6 — reserved for future use	—	6 — sailing
7 — cargo ships	7 — reserved for future use	—	7 — pleasure craft
8 — tankers	8 — reserved for future use	—	8 — reserved for future use
9 — other types of ship	9 — no additional information	—	9 — reserved for future use
<p><sup>1</sup> The identifier shall be constructed by selecting the appropriate first and second digits. For example, a cargo ship not carrying dangerous goods, harmful substances, or marine pollutants, shall use identifier "70"; pleasure craft shall use identifier "37". Note that those ships, which type identifier begins with a "3" shall use the fourth column of the Table.</p> <p>Depending on the vessel, cargo and/or the navigational conditions, this information may be voyage related and shall therefore need to be changed before beginning or at some time during the voyage. This is defined by the "second digit" in the fourth column of the Table.</p> <p><sup>2</sup> Figures 1, 2, 3, 4, indicating categories X, Y, Z and OS, have previously indicated categories A, B, C and D.</p>			

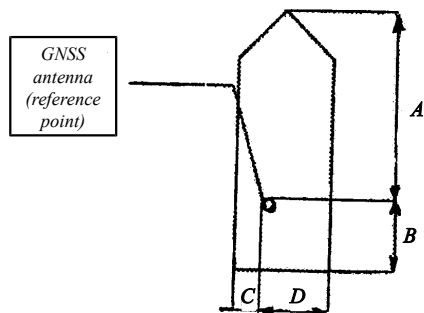

Fig. 5.3.1 Antenna position parameters:

Ship's dimensions	Distance at which the antenna is located, in m
<i>A</i>	0 – 511 (511 = 511 m or greater)
<i>B</i>	0 – 511 (511 = 511 m or greater)
<i>C</i>	0 – 63 (63 = 63 m or greater)
<i>D</i>	0 – 63

- Notes:
1. The dimension *A* shall be in the direction of the transmitted heading information (bow).
  2. Reference point of reported position not available, but dimensions of ship are available:  $A = C = 0$  and  $B \neq 0$  and  $D \neq 0$ .
  3. Neither reference point of reported position nor dimensions of ship available:  $A = B = C = D = 0$  (= default).
  4. For use in the message table: *A* = most significant field; *D* = least significant field.
  5. In the rare case of a GNSS antenna installed in the portside corner of a rectangular bow, the values *A* and *C* would be zero. Should this be the case, one of these values shall be set to 1 in order to avoid misinterpretation as "not available" because  $A = C = 0$  is used for that purpose.

## **GUIDELINES FOR THE INSTALLATION OF A SHIPBORNE RADAR**

### **1 GENERAL**

**1.1** These Guidelines reflect the provisions of IMO circular SN.1/Circ.271 "Guidelines for the Installation of Shipborne Radar Equipment".

Information provided by radar is of vital importance for navigators and the safe navigation of ships. Special care shall be taken to ensure the correct installation of the radar, in order to improve the performance of the radar system.

The Appendix contains guidelines for shipowners, ship designers, manufacturers, installers, shipyards, suppliers and ship surveyors.

It does not replace documentation supplied by the firm (manufacturer).

### **2 APPLICATION**

**2.1** The Appendix applies to all shipborne radar installations mandated by SOLAS-74, as amended.

### **3 DEFINITIONS**

**3.1** Consistent common reference point (CCRP) is a location on own ship, to which all horizontal measurements such as target range, bearing, relative course, relative speed, closest point of approach (CPA) or time to closest point of approach (TCPA) are referenced, typically the conning position of the bridge.

### **4 SURVEY**

**4.1** Surveys of the conventional ships shall be carried out in accordance with the rules laid down in IMO resolution A.997(25).

### **5 DOCUMENTATION**

**5.1** Prior to the radar installation, the following documentation shall be made available and provided to the installer by the shipyard, shipowner or manufacturer as appropriate:

**.1** scaled drawing(s) of the ship with views from the port, starboard, fore, aft and from above the vessel on which the radar and other antenna positions are indicated. Any ship structure or cargo that may obstruct or degrade radar performance shall also be shown, for example masts, funnels, superstructure and containers. The possible turning and jib range of movable objects like cranes shall be indicated;

**.2** scaled drawing of the antenna arrangement including the outline drawing for the rotation radius;

**.3** drawing(s) of the bridge layout showing the position of the radar display unit(s) and additional locations (for example, electronic rooms) for housing radar units;

**.4** manufacturer's documentation describing the installation and interconnection of the radar system, the equipment units including radar frequency band and antenna size, and equipment type and evidence of type approval documentation;

.5 list of auxiliary equipment connected with the radar system including manufacturer, type with block diagram (interconnection diagram) and evidence of type approval;

.6 in case of retrofit installations, a document agreed by the shipowner, installer and manufacturer stating that the use of original cabling, transmission lines and auxiliary units of the radar equipment may be retained.

## 6 RADAR ANTENNA INSTALLATION

Correct location of the radar antenna is an important factor of the performance of the radar system. Interference, either by reflecting constructions or other transmitters, may heavily reduce the radar performance by creating blind sectors, clutter on the radar display or generation of false echoes.

### 6.1 Interference.

6.1.1 Due care shall be taken with regard to the location of radar antennas relative to other antennas which may cause interference to either equipment. The location of the antenna shall comply with the following:

.1 the radar antenna shall be installed safely away from interfering high-power energy sources and other transmitting and receiving radio antennas;

.2 the lower edge of a radar antenna shall be minimum of 500 mm above any safely rail;

.3 radar antennas in close proximity shall have a minimum vertical elevation separation angle of 20° and a minimum vertical separation of 1 m where possible.

### 6.2 Location relative to masts, funnels and other constructions.

6.2.1 Due care shall be taken with regard to the location of radar antennas relative to masts, funnels and other constructions.

The location of the antenna shall comply with the following:

.1 the antenna shall generally be mounted clear of any structure that may cause signal reflections;

.2 ensure that any support or other obstacles are clear of the rotation of the antenna (refer to specific antenna outline drawing for rotational radius);

.3 install antenna and turning unit so that the installation complies with the compass safe distance of the equipment.

### 6.3 Blind sectors and range.

6.3.1 To make full benefit from the radar, it is vitally important that horizontal and vertical blind sectors of the radar antennae are minimized. The objective shall see the horizon freely through 360° as nearly as possible, noting the requirement of 8 below.

For all radar systems and where practical:

.1 a line of sight from the radar antenna to the bow of the ship shall hit the surface of the sea in not more than 500 m or twice the ship length, depending which value is smaller, for all load and trim conditions;

.2 the radar antenna shall be located in an elevated position to permit maximum target visibility;

.3 blind sectors shall be kept to a minimum, and shall not occur in an arc of the horizon from right ahead to 22,5° abaft the beam to either side.

Note. Any two blind sectors separated by 3° or less shall be treated as one blind sector;

.4 individual blind sectors of more than 5°, or a total arc of blind sectors of more than 20°, shall not occur in the remaining arc, excluding the arc in the above 6.3.3;

.5 for radar installations with two radar systems, where possible, the antennas shall be placed in such a way as to minimize the blind sectors.

#### **6.4 Lifting radar equipment**

**6.4.1** Where special equipment, such as cranes, hoists and jibs are required to install the radar system, consideration shall be given to ensure that the radar system(s) are located such that the required equipment can be positioned to facilitate the installation. Radar equipment shall be lifted in accordance with the information provided by the manufacturer.

### **7 GENERAL REQUIREMENTS**

**7.1** All installations shall facilitate protection of equipment, including cabling, from damage.

**7.2** Safe service access shall be provided using service platforms where necessary having a minimum size of 1 m<sup>2</sup> at a suitable height and with a safety rail of suitable height.

**7.3** Consideration shall be given to the compass safety distance as supplied by the manufacturer when positioning equipment units.

**7.4** The design of the mounting platform for the antenna and antenna pedestal shall take into account vibration, shock and whiplash due to sea-going conditions.

### **8 INTERACTION WITH SEA AND FALSE ECHOES**

**8.1** Considerations of interaction with the sea imply that the radar antenna shall be only as high as necessary to clear major objects, and as high to be consistent with other requirements regarding acceptable horizon and target detection range.

The location of the antenna shall minimize sea clutter returns and the number of multi-path nulls.

### **9 CABLES AND GROUNDING**

**9.1** The cables and the grounding shall comply with the following:

**.1** cable screens, especially coaxial cable screens, shall be installed in accordance with firm's (manufacturer's) documentation;

**.2** the cables shall be kept as short as possible to minimize attenuation of the signal;

**.3** all cables between antenna and radar systems units shall be routed as directly as possible, consistent with consideration for other equipment, in order to reduce electromagnetic interference effects;

**.4** cables shall not be installed close to high-power lines, such as radar or radiotransmitter lines;

**.5** crossing of cables shall be done at right angles (90°) to minimize magnetic field coupling;

**.6** all outdoor installed connectors shall be waterproof by design to protect against water penetration into the cables (IP56 protection degree);

**.7** cables and microwave transmission lines shall not be exposed to sharp bends;

**.8** cables and microwave lines shall be installed with sufficient physical separation, as defined in the firm's (manufacturer's) documentation;

**.9** grounding of equipment units shall be carried out according to the firm's (manufacturer's) documentation.

### **10 POWER SOURCES**

**10.1** The radar shall be connected to the main and emergency power source, as required by SOLAS-74 chapter II-1.

## **11 RADAR CONTROLS AND DISPLAY**

**11.1** If the control panel is a separate unit, the functionality of the radar controls shall be available for the mariner at all workstations where a radar display is available.

**11.2** The orientation of the display unit shall be such that the user is looking ahead. The lookout view shall not be obscured and the ambient light shall cause minimum degradation on the display screen in accordance with IMO circular MSC/Circ. 982).

## **12 INITIAL INSTALLATION OF RADAR**

**12.1** Radar systems are functionally integrated with a number of instruments (refer to IMO resolution MSC.192(79)). As various systems are getting increasingly more integrated and complex, correct system settings are very important.

The installation firm shall sign an installation report that to the best of their knowledge the installation and setup has been carried out according to the firm's (manufacturer's) documentation and to these guidelines.

Information about possible performance limitations, including blind sectors, due to the radar system installation that may be of vital importance for mariners shall be stated in this documentation.

The setup of interfaces and system parameters (including CCRP position offset) shall be carried out in accordance with the firm's (manufacturer's) documentation.

This information shall be attached as an annex to the installation report.

The above mentioned installation report and the annex thereto shall be kept on board the ship.

Российский морской регистр судоходства  
**Правила по оборудованию морских судов**  
**Часть V**  
**Навигационное оборудование**

Russian Maritime Register of Shipping  
**Rules for the Equipment of Sea-Going Ships**  
**Part V**  
**Navigational Equipment**

The edition is prepared  
by Russian Maritime Register of Shipping  
8, Dvortsovaya Naberezhnaya,  
191186, St. Petersburg,  
Russian Federation  
[www.rs-class.org/en/](http://www.rs-class.org/en/)